



CODEN [USA]: IAJPBB

ISSN : 2349-7750

**INDO AMERICAN JOURNAL OF
PHARMACEUTICAL SCIENCES**

SJIF Impact Factor: 7.187

Available online at: <http://www.iajps.com>

Review Article

REVIEW PROJECT REPORT ON CONDUCTOMETER¹Priya Gautam Suradkar, ²Yogiraj. G. Muley¹Student of bachelor of pharmacy, faculty of pharmacy, Dr. Babasaheb Ambedkar Technological University, Lonere, Raigad.² Department of pharmaceutical chemistry, Faculty of chemistry, Dr. Babasaheb Ambedkar Technological University, Lonere, Raigad.**Article Received: May 2024****Accepted: May 2024****Published: June 2024****Abstract:**

Conduct metric titration is an analytical method used to determine the concentration of ionizable species in a solution by measuring its electrical conductivity. This study aims to investigate the conductometric titration of a mixture of a strong acid, hydrochloric acid (HCl), and a weak acid, acetic acid (CH₃COOH), with a strong base, sodium hydroxide (NaOH).

During the titration, the conductivity of the solution changes as the strong acid and the weak acid react with the strong base. The strong acid dissociates completely in water, contributing a high number of ions to the solution, while the weak acid partially dissociates, contributing fewer ions. As NaOH is added, it neutralizes the acids, leading to a decrease in the solution's conductivity. The end point of the titration is determined by a marked change in the conductivity curve.

The results demonstrate distinct conductivity behavior for the strong and weak acids, allowing for their differentiation and accurate determination of their concentrations in the mixture. This method provides a reliable and efficient means of analyzing mixtures of strong and weak acids, with applications in various fields including environmental monitoring, industrial process control, and chemical research [1]

Keywords: Conductometric titration, Analysis, equivalence, weak acid, strong acid, electrolytes, conductivity, conductance.

Corresponding author:**Priya Gautam Suradkar,**

Student of bachelor of pharmacy,

Faculty of pharmacy, Dr. Babasaheb Ambedkar

Technological University, Lonere, Raigad.

QR code



Please cite this article in press Priya Gautam Suradkar et al., *Review Project Report On Conductometer*, Indo Am. J. P. Sci, 2024; 11 (6).

1. INTRODUCTION:

Conductometry is a measurement of electrolytic conductivity to monitor a progress a chemical reaction. Conductometry has notable application in analytical chemistry where, conductometric titration is a standard technique. In usual analytical chemistry practice, the term conductometry is used to describe non-titrative application. Conductometry is often applied to determine the total conductance is a solution or to analyse the end point of titration that include ions.

In this type of titration upon the continuous addition of the titrant and the continuous

Fig No. 01:- conductivity meter



Recording of the corresponding change in electrolytic conductivity. A sudden change in the conductivity implies that the stoichiometric points has been reached. The increase or decrease in the electrolytic conductivity in the conductometric titration process is linked to change in the concentration of hydroxyl and hydrogen ions (which are the two most conducting ions). The strength of an acid can be determined via conductometric titration with a standard solution of a base. Conductometry is the measurement of the electrical conductivity of a solution. The conductance is defined as current flow through the conductor. In other words, it is defined as the reciprocal of the resistance. [3]

The unit for the conductance is (Siemens) which is the reciprocal of Ohm's (Ω^{-1})

1.1 Electric conductivity of an electrolyte solution depends on:

Type of ions (Cations, Anions, Singly, Or charged).

- Concentration of ions .
- Temperature
- Mobility of ions.

1.3 Important definition and relations.

- **Conductance (G):-** ease with which current flows per unit area conductor per unit Potential applied and is reciprocal to resistance (R). it's unit is Siemens (ohm⁻¹). $G = 1/R$
- **Resistance (R):-** Is a measure of the conductor is opposition to the flow of electric charge ,it's unit is ohm .
 $R = 1/G$
- **Specific resistance:-** resistance offered by substance of 1cm length 1 cm (l) 1 sq.cmsurface area (A) it's unit is ohm cm.
- **Specific conductivity (Kv):-** Conductivity offered by a substance of 1cm length and 1cm sq.cmsurface area it's unit is mhos cm⁻¹.
- **Equivalent conductivity:-** conductivity of a solution containing equivalent weight of the solute between electrodes 1 cm apart and 1sq.cm surface area it's unit is Mhos cm⁻¹.
- **Molar conductivity:-** conductivity of a solution containing molecular weight of the solute between electrodes 1cm apart and 1sq.cm surface area.[6]

2. Research problem

The strength of an acid in pharmaceuticals can significantly influence various aspects of drug formulation, stability, solubility, bioavailability and pharmacokinetics.

1. Solubility: The solubility of a drug can be influenced by the pH of the environment. Weak acids tend to be more soluble in basic solutions, while weak bases are more soluble in acidic solutions. This is crucial for ensuring that the drug dissolves adequately in the gastrointestinal tract, where the pH varies.

2. Stability: Acid strength can affect the stability of a drug. Some drugs may degrade in acidic or basic environments, leading to a loss of potency. The pH of the formulation must be carefully controlled to maintain the drug's stability over its shelf life.

3. Bioavailability: The extent and rate at which the active drug ingredient is absorbed and becomes available at the site of action can be affected by acid strength. For example, drugs that are weak acids may

be better absorbed in the acidic environment of the stomach, whereas drugs that are weak bases may be absorbed better in the more basic environment of the intestines.

4. Ionization: The degree of ionization of a drug, which depends on its acid dissociation constant (pKa) and the pH of the environment, affects its absorption and distribution. Non-ionized forms of drugs are generally more lipophilic and can cross cell membranes more easily, whereas ionized forms are more hydrophilic and may have difficulty crossing lipid membranes.

5. Formulation: The formulation of the drug, including its salt form, can be influenced by its acid strength. Salts of weak acids or bases are often used to enhance solubility and stability. For example, aspirin is formulated as acetylsalicylic acid, a weak acid, and some medications are formulated as their hydrochloride salts to improve solubility.

6. Taste: The taste of oral medications can be influenced by their acid strength. Drugs that are strong acids or bases can have a bitter or unpleasant taste, which can be a significant factor in patient compliance.

7. Compatibility with Excipients: Acid strength can affect the compatibility of the drug with other components in the formulation, such as excipients, fillers, and preservatives. Incompatible interactions can lead to reduced efficacy or stability.

8. Release Profile: In controlled-release formulations, the acid strength can influence the drug's release profile. For example, enteric-coated tablets are designed to resist the acidic environment of the stomach and dissolve in the more neutral or basic environment of the intestines.

Understanding and controlling the acid strength of pharmaceutical compounds are crucial for optimizing their therapeutic efficacy and ensuring patient safety

3. Hypothesis statement :

In this project work we go to perform conductometric titration of a mixture of strong acid and weak acid with strong base. Conductance changes during titration are measured by conductometer. This equivalence point of the titration are detected by plotting a titration curve using conductance values and volumes of base added. [9]

4. Literature review:

The whole literature from the peer-reviewed research was collected using the web sources viz. Google search (<http://www.google.co.in>), Research gate, Google scholars ([http://www. Scholars.Google.co.in](http://www.Scholars.Google.co.in)), CERA facility, HAU/ICAR

5. Objective:

- Perform a conductometric titration of a mixture of strong acid and weak acid with strong base.
- Determine the equivalence point of the titration by plotting titration curve using conductance values and amount of the base added during titration.
- Estimate the strength of the both constituents of the mixture.
- State the advantages conductometric titration.
- Practice the precautions while performing conductometric titration experiment.
- Understanding principles and operations of conductometer.[5]

6. History

Conductive measurements began as early as the 18th century, when Andreas Baumgartner noticed that salt and mineral waters from Bad Gastein in Austria conducted electricity. As such using conductometry to determine water purity which is often used today to test the effectiveness of water purification systems began in 1776.

Friedrich Kohlrausch further developed conductometry in the 1860s when he applied alternating current to water, acids, and other solutions. It was also around this time when Willis Whitney, who was studying the interactions of sulphuric acid and chromium sulphate complexes, found the first conduct metric endpoint. These finding culminated into potentiometric titrations and the first instrument for volumetric analysis by Robert befriendling 1883 while titrating chloride and bromide with HgNO_3 . This development allowed for testing the solubility of salts and hydrogen ion concentration, as well as acid/base and redox titrations. Conductometry was further improved with the development of the glass electrode, which began in 1909.[11]

7. Principle of conductometry

Conductometry is based on the principle of determination of change in conductivity; change in conductance is due to replacement of ions with each other. Ionic conductivity is different for ions.

For example, if we carry out reaction in between HCl and NaOH then in this reaction H^+ ions replaced by Na^+ ions then conductivity decrease because conductivity of H^+ is higher than Na^+ .

Movement of ions is mainly depend upon the concentration of ions.[2]

7.1 Principle of conduct metric titration.

The of end point of a titration by means of conductivity measurements is known as conduct conductometric titration.

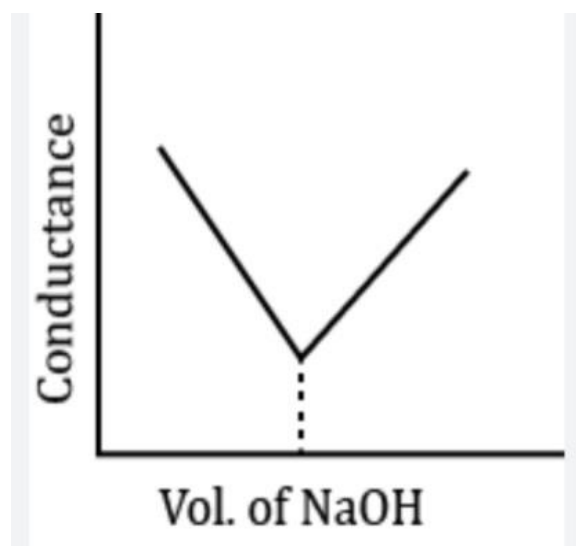

Fig No. 02:- Graph Of strong acid & strong base

During the course of titration the conductivity of the solution changes ,since there is change in the number and mobility of ions At the end point of titration there is sharp change in the conductivity of a solution shown by the intersection of lines in the graph of conductivity Vs volume of titrant added.

A graph is plotted between change in conductance and volume of titrant added. By this graph an equivalence point can be detected. When a mixture of a strong acid and a weak acid is titrated with a strong base or a weak base, titration curve similar to is obtained. In this curve there are two break points. The first break point corresponds to the neutralization of strong acid. When the strong acid has been completely neutralized only then the weak acid starts neutralizing. The second break point corresponds to the neutralization of weak acid and after that the conductance increases due to the excess of OH⁻ ions in case of a strong base as the titrant. However, when the titrant is a weak base, it remains almost constant after the end point .The instrument used for the measurement Of conductance are known as conductometer consist of

8.Construction

8.1.Current source

- Mechanical high frequency AC generator by Washburn.
- Dc current is not employed in conductance measurement because electrodes becomes polarised leading to high cell resistance.

8.2. Conductivity cell

- Made of Pyrex or quartz and are fitted with two platinum electrodes
- Should be placed in vessels containing water to maintain constant temperature.

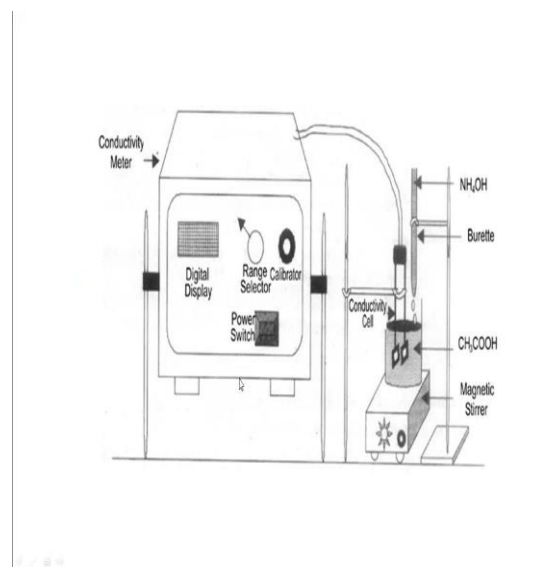

Fig No.03:- Construction of Conductivity meter

8.3 .Types

1. Wide mouthed cell
2. Cell for reactions producing precipitations
3. Dip type cell.

8.4. Electrodes

- Platinum sheets each of 1cm are fixed at distance of 1cm.
- The surface is coated with platinum black to avoid polarization effect and increase effective surface area.
- Politicisation of electrodes is done by coating solution of 3% chlorplatinic acid and lead acetate on it to get uniform coating.
- Electrodes usage depends on conductivity and concentration.
- If concentration is low then electrodes should be largely and closely packed.



Fig no.04:-Electrodes of Conductivity meter

8.5. Measurement

- The instrument used to measure conductance is called conductance bridge or conductometer.
- Classical circuit employed for measurement is Wheatstone bridge.

Various types are:

- Kohlrausch conductance bridge
- Direct reading conductance bridge
- Philips conductance bridge
- Mullard's conductance bridge
- Pye's conductance bridge

Cell constant : the measured conductivity (I/R) is not equal to the specific conductivity of solution because the physical configuration of platinum electrode i.e length and area of electrodes varies from one another. Hence conductivity of solution is obtained by calculating factor called "cell constant." [14]

- defined as ratio distance between the two electrodes (l) to the area of electrodes (A).

8.6. Types of conduct metric titration.

1. Acid base or neutral titration.

- strong acid with a strong base
e.g HCl with NaOH.

When the base is added in HCl solution, the conductance falls due to the replacement of hydrogen ions by the added Cations as H^+ ions react with OH^- ions to form dissociated water.

After the equivalence point, the conductance due to the large conductivity OH^- ions.

2. Weak acid with a strong base

e.g acetic acid with NaOH.

Fig No.05 :- Conductometric titration of a strong acid (HCL)vs Strong Base(NaCl)

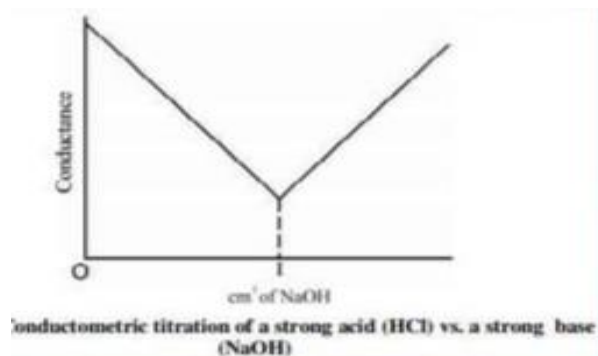

Conductometric titration of a strong acid (HCl) vs. a strong base (NaOH)

- Initially conductance low due to the feble ionization of acetic acid followed by increased due to Naoh.
- Beyond the equivalence point step rise due to excess of naoh .
Strong acid with a weak base e.g sulphuric acid with a ammonia
Initially the conductance is high and then it decreases due to replacement of H^+ .
- But after the end point is reached the graph becomes almost horizontal ,since the excess the aqueous ammonia is not appreciably ionised in the presence of ammonium sulphate.[19]

Fig no.6:- Conductometric titration of a strong acid (H2SO4)Vs A weak base(NH4OH)

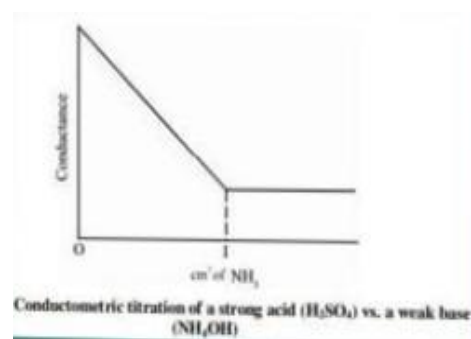

3.weak acid with a weak base

e.g sulphuric acid with a dilute ammonia.

- The Nature of curve before the equivalence point is similar to the curve obtained by titrating weak acid against strong base .
- After the equivalence point conductance virtually remains same as the weak base which is being is feebly ionized and therefore is not much conducting.

Fig No. 07 :- Conductometric titration of a weak acid (Acetic Acid) Vs A weak base(NH₄OH)

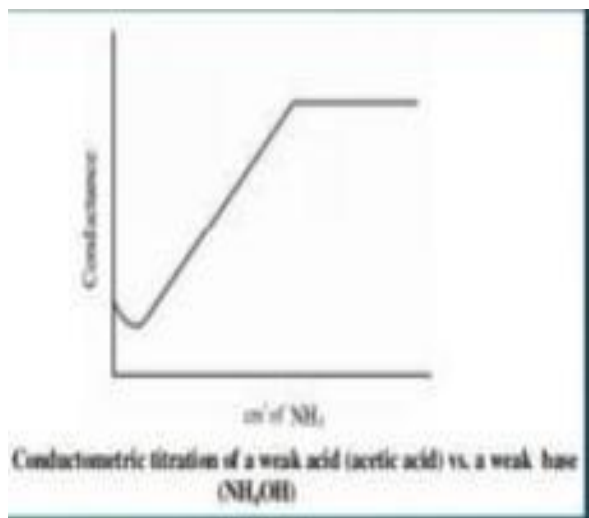

4.Precipitation titration

e.g Potassium chloride Vs Silver nitrate

- When silver nitrate added, the first part of the curve shows no increase in conductivity as there is only replacement of chloride ions with nitrate ions. After end point conductivity increases because of increase concentration of silver as well as nitrate ions.

Chemical reaction :-

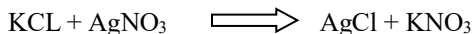

9.Working of conductometer:

A working conductivity meter, also known as a conductometer, measures the electrical conductivity of a solution. This measurement is often used to determine the ion concentration in the solution, which correlates to its ability to conduct electricity. Here's a brief overview of how it works:

- Electrodes:** The meter has two electrodes, usually made of platinum, that are placed in the solution.
- Current Application:** An alternating current (AC) is applied between the electrodes.
- Measurement:** The meter measures the voltage drop between the electrodes, which is affected by the resistance of the solution. The conductivity is inversely related to this resistance.
- Calibration:** The meter is calibrated using standard solutions of known conductivity to ensure accurate measurements.
- Display:** The conductivity reading is displayed, typically in microsiemens per

centimeter ($\mu\text{S}/\text{cm}$) or millisiemens per centimeter (mS/cm).

9.1.Steps to Use a Conductivity Meter:

- 1. Calibration of meter:** Use a standard calibration solution to ensure accuracy.
- 2. Rinse Electrodes:** Rinse the electrodes with deionized water to remove any contaminants.
- 3. Immerse Electrodes:** Place the electrodes in the solution to be measured.
- 4. Read Conductivity:** Wait for the reading to stabilize and then record the conductivity value.
- 5. Clean Electrodes:** After use, rinse the electrodes thoroughly to prevent contamination for future measure

10.Application :

- Solubility of sparingly soluble salts like AgCl , BaSO_4 , can be detected.
- Check water pollution in rivers and lakes.
- Alkalinity of fresh water.
- Salinity of sea water (oceanography).
- Used to trace antibiotics.
- Deuterium ion concentration in water - deuterium mixture.
- Food microbiology - for tracing microorganisms.
- Tracing antibiotics.
- Estimate ash Content in sugar juices.
- Purity of distilled and de-ionized water can be determined.
- Determination of atmospheric No need of indicator.
- Colored or dilute solutions or turbid suspensions can be used for titrations.
- Temperature is maintained constant throughout the titration.
- End point can be determined accurately and errors are minimized as the end point is being determined graphically.
- estimation of vanillin in vanilla flavour.
- Check the level of basicity in various organic acids.
- Hydroponics.
- Industrial process.
- Environmental monitoring.
- Aqua culture[9]

11. Advantages.

- No need of indicator.
- Colored or dilute solutions or turbid suspensions can be used for titrations.

- Temperature is maintained constant throughout the titration.
- End point can be determined accurately and errors are minimized as the end point is being determined graphically.
- This process is very useful in the titrations of very dilute solutions and weak acids.
- The end-point of this method of titration is very sharp and accurate when compared to a few other titration processes.
- This type of titration is applicable for solutions that are coloured or turbid, and for which the endpoint of the titration with normal indicators cannot be observed easily by the human eye.
- Conductometric titration has numerous applications in acid-base titration, redox titration, precipitation titrations, and complex titrations[17].

12. Disadvantages

- Only a few specific redox titrations can be done with the help of this process. This is because the conductivity of the solution is masked by relatively high hydronium ion concentration.
- The accuracy of conductometric titration is low when the concentrations of the electrolyte are high, making the titration process unsatisfactory.
- Increased level of salts in solution of masks the conductivity changes in such cases it does not give accurate results .
- Application of conductometric titration to redox system is limited because high concentration of hydronium ions in the solution tends to mask the changes in conductance.
- Ok the high concentration of other electrolytes.

13. Case study :

Title: Conductometric titration of a mixture of a strong acid (HCl) and weak acid CH₃COOH with a strong base

Aim: -To the estimation of acids in acid mixture by conductometric titration.

Requirements:

A) Apparatus:

- Burette
- Beaker
- Measuring cylinder

- Pipette(10 ml)
- Burette stand

B) Chemicals:

- Hydrochloric acid
- Acetic acid
- Sodium hydroxide
- Distilled water

Instrument:- Conductivity meter .

Principle:- when a mixture of a strong acid and a weak acid is titrated with a strong base or a weak base, a titration curve is obtained. In this curve there are two break points. The first break point corresponds to the neutralization of strong acid. When the strong acid has been completely neutralized only then the weak acid starts neutralizing. The second break point corresponds to the neutralization of weak acid and after that the conductance increases due to the excess of OH⁻ ions in case of a strong base as the titrant. However, when the titrant is a weak base, it remains almost constant after the end point.[20]

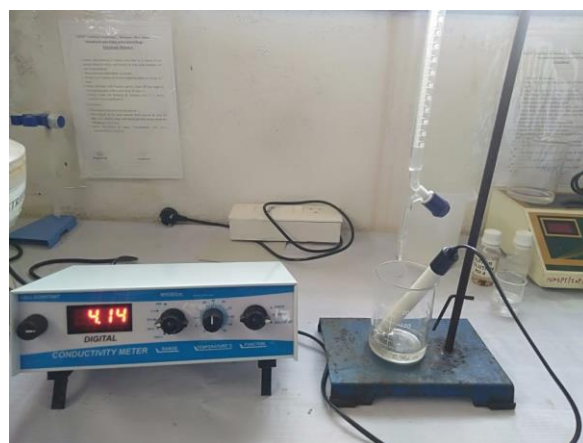

Procedure:

1. Take 30 ml of given solution [mixture of ~ 0.1 M HCl (15 ml) and ~ 0.1 M acetic acid (15 ml)] in a beaker and dip the conductance cell into it.
2. Take NaOH solution in the burette.
3. Connect the conductometer to the mains and to the conductance cell. Switch on the instrument keeping the meter switch at 'CAL'.
4. Calibrate the meter keeping the selector knob at "20 mS" by rotating the sensitivity knob till the meter reads 1.0.
5. Shift the meter switch to 'READ'. Read the conductance of the solution. Record this value in observation Table .
6. Make additions of NaOH from the burette . After each addition, stir the solution well and read the conductance. Enter all the conductance values in

observation Table . 7. Plot conductance versus volume of NaOH on a graph sheet and calculate the

volume of NaOH used for the neutralization of HCl and acetic acid.

Observation:

Observation table :-conductometric titration of mixture of strong acid and weak acid Vs strong base .

Volume of Naoh added(ml)	Conductance
0.0	11.45
0.5	9.94
1.0	7.89
1.5	5.65
2.0	4.15
2.5	4.65
3.0	4.71
3.5	5.26
4.0	5.96
4.5	6.13
5.0	7.04
5.5	7.13
6.0	7.80
6.5	7.81
7.0	8.03
7.5	8.60
8.0	9.03
8.5	9.30
9.0	9.70
9.5	9.73
10	9.80

14.Graph

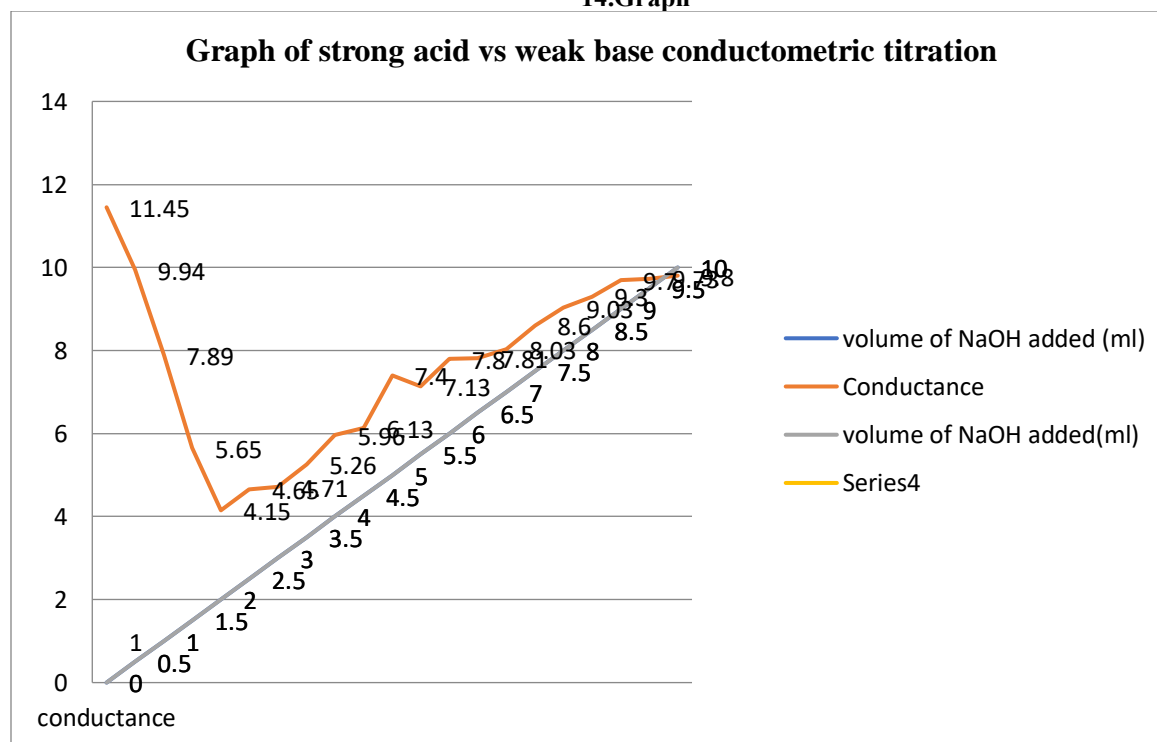

15. calculation:**Given data:**

volume of the acid mixture taken = 30 ml
 Mixture of 0.1 M HCl (15ml) and 0.1M acetic acid (15ml)
 Molarity of standardized NaOH solution = M 1 mol dm⁻³ = 0.5 mol dm⁻³.

1. From the graph, the first change in slope of the conductometric curve gives the first equivalence point (obtained after complete neutralisation of HCl present in the acid mixture). From which volume of NaOH corresponding to this first equivalence point V₁ (ml) can be determined.

2. Similarly, the volume of NaOH, corresponding to the second equivalence point V₂ (ml)

3. Total volume of NaOH used for the complete neutralization of both the acids can be determined from the graph. Volume NaOH used for the neutralisation of weak acid = (V₂ - V₁) ml.

- The molarity of strong acid (HCl) = 20.1 mol dm⁻³
- Volume of the strong acid taken = 15 ml
- Molarity of the weak acid (CH₃COOH) = 0.1 M mol dm³
- V₁ = 4.15
- V₂ = 9.03
- Volume of the weak acid is taken = 15 ml.

16. Result:

- Molarity of HCl = $M_1 V_1 / 15 \text{ mol dm}^{-3}$
 $= 0.5(4.15) / 15 = 2.075 / 15$
 $= \mathbf{0.138 \text{ mol dm}^{-3}}$
- Molarity of CH₃COOH = $M_1 (V_2 - V_1) / 15 \text{ mol dm}^{-3}$
 $= 0.5(4.88) / 15$
 $= \mathbf{0.162 \text{ mol dm}^{-3}}$
- Molarity of HCl is **1.38 mol dm⁻³**
- Molarity of CH₃COOH is **0.16 Mol dm³**.

17. CONCLUSION:

In conclusion, the conductometer is widely used in element electronic circuits with several advantages and disadvantages. Its simple construction, low cost, ease of operation, wide range of resistance values, accuracy, proven technology, no need of indicator are some of its advantages. The goal of this Conductometric titration is to determine the concentration of a known solution, by titrating it with another strong electrolyte that will react with the first substance, and enter a non-ionic state. By doing this,

we change the number of ions in the solution, and thus change its conductivity.

18. REFERENCE:

1. Dominguez V. C.; McDonald C. R.; Johnson M.; Schunk D.; Kreuter R.; Sykes D.; Wigton B. T.; Chohan B. S. *J. Chem. Educ.* 2010, 87, 987–991.
2. McDonald, C.; Johnson, M.; Schunk, D.; Kreuter, R.; Sykes, D.; Wigton, B.; Chohan, B. *J. Chem. Educ.* 2011, 88, 1182–1187.
3. Wigton, B.; Kreuter, R.; Sykes, D.; Chohan, B. *J. Chem. Educ.* 2011, 88, 1188–1193.
4. B. S.; Sykes, D. G.; ACS Symposium Series, 2013, Chapter 6, 105–138.
5. Mott, J. R.; Munson, P. J.; Sykes, D.; Chohan, B. S. *J. Chem. Educ.* 2014, 91, 1028–1036.
6. C. M.; Nichisti, Kreuter, R.; Sykes, D.; Chohan, B. S. *Food Analytical Methods* 2015, 8, 929–936.
7. Clippard, C. M.; Hughes, W.; Chohan, B. S.; Sykes, D. G. *J. Chem. Educ.* 2016, 93, 1241–1248. [006/jcis.1994.1115](https://doi.org/10.1006/jcis.1994.1115)
8. Zwetsloot, J. P. H., and J. C. Leyte. "Conductometric Titration of Latex with Acidic Surface Groups." *Journal of Colloid and Interface Science* 163, no. 2 (March 1994): 362–71. <http://dx.doi.org/10.1006/jcis.1994.1115>.
9. Adam C. Lee and Gordon M. Crippen. Predicting pK_a. *Journal of Chemical Information and Modeling* 2009, 49 (9), 2013–2033. <https://doi.org/10.1021/ci900209w>.
10. Nikolaus Doppelhammer, Nick Pellens, Bernhard Jakoby, Christine E.A. Kirschhock, Erwin K. Reichel. Monitoring Zeolite Formation with Moving Electrode Conductometry. 2021, 1–4. <https://doi.org/10.1109/SENSOR47087.2021.9639654>
11. Bibliographie Néerlandaise. *Recueil des Travaux Chimiques des Pays-Bas* 1931, 164–164. <https://doi.org/10.1002/recl.19310500210>
12. Yan Wang, Jinling Geng, Zhiwei Zhu. A Comprehensive Teaching Laboratory Program on Titration Analysis: Transition from Classic to Modern Approaches. *Journal of Chemical Education* 2024, 101 (2), 612–620. <https://doi.org/10.1021/acs.jchemed.3c01091>
13. "Quantitative Chemical Analysis" by Daniel C. Harris.
14. Vogel's Textbook of Quantitative Chemical Analysis" by J. Mendham et al.
15. Bektursynova A.P., Dzhumanazarova Z.K. Science and education in Karakalpakstan. Study of the conductometric titration of barium nitrate with a urea ligand. 86–88 p, 4/2 *con Hykyc* 2022.

14. Arun Bahl, B. S. Bahl & G. D. Tuli, Essentials of Physical Chemistry, S. Chand and Company Ltd., New Delhi, 2012
15. Conductometric and potentiometric titration. Waław Grzybkowski Gdańsk 2002.
16. L. V. Leonel, A. Righi, W. N. Mussel, J. B. Silva and N. D. S. Mohallem, Structural characterization of barium titanate-cobalt ferrite composite powders, *Ceram. Int.*, 37(4), 1259-1264 (2011).
17. G. B. Martinenghi. Beitrag zur Analyse des Olivenöls. *Fette und Seifen* **1939**, 46 (6) , 333-337. <https://doi.org/10.1002/lipi.19390460603>
18. Yan Wang, Jinling Geng, Zhiwei Zhu. A Comprehensive Teaching Laboratory Program on Titration Analysis: Transition from Classic to Modern Approaches. *Journal of Chemical Education* **2024**, 101 (2) , 612-620. <https://doi.org/10.1021/acs.jchemed.3c01091>
19. Julia Martin, Gabriel Delgado Martin, Agustin G. Asuero. Intersecting Straight Lines: Titrimetric Applications. **2017** <https://doi.org/10.5772/intechopen.68827>
20. Laidler, K.J.: Chemical Kinetics. Harper & Row, New York (1987)