

EUCARPIA

EUROPEAN ASSOCIATION FOR RESEARCH ON PLANT BREEDING

XIIth Meeting on Genetics and Breeding of *Capsicum* and Eggplant

Noordwijkerhout, The Netherlands
May 17-19, 2004

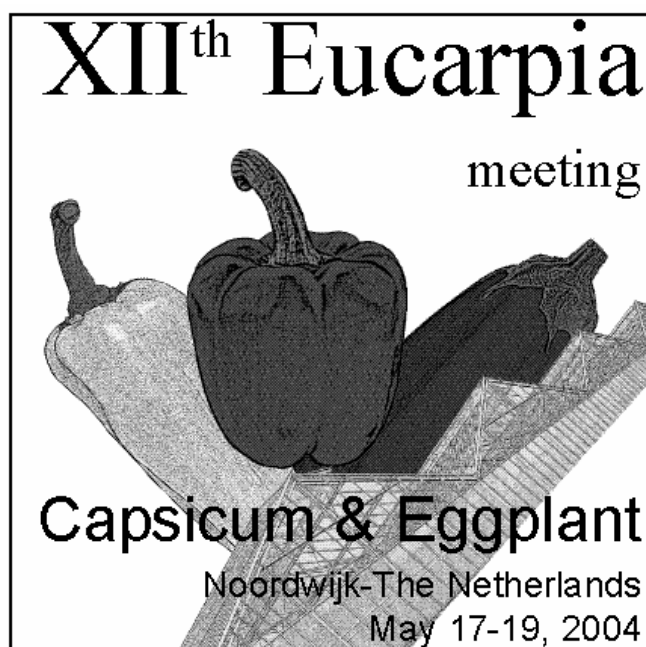

Plantum NL

Plant Research International

Correct reference:

Proceedings of the XIIth EUCARPIA Meeting on Genetics and Breeding of *Capsicum* and Eggplant, May 17-19, 2004. Noordwijkerhout, The Netherlands.

Editor:

R.E. VOORRIPS
Plant Research International
Wageningen UR
P.O. Box 16
6700 AA Wageningen
The Netherlands

ORGANIZING COMMITTEE

Jair Haanstra (Chairman), Harriette Aarden, Tom van der Heiden, Herman Koning, Jurko Leij, Clemens Stolk, Dick Vreugdenhil, Roeland Voorrips

SCIENTIFIC COMMITTEE

Roeland Voorrips, Jair Haanstra, Ietje Boukema (The Netherlands), Alain Palloix, Marie-Christine Daunay (France), Istvan Nagy (Hungary), Piero Belletti (Italy), Kazim Abak (Turkey), Paul Bosland (USA)

ACKNOWLEDGEMENTS

The meeting has been supported by the following institutions and companies:

EUCARPIA

Plantum NL

Plant Research International

De Ruiter Seeds

Enza Zaden

Nunhems

Rijk Zwaan

Seminis Vegetable Seeds Europe

Syngenta Seeds

Western Seed

Naktuinbouw

FOREWORD

This book contains the Proceedings of the XIIth Meeting on Genetics and Breeding of *Capsicum* and Eggplant, held on 17-19 May, 2004. Since the first meeting, held in Torino (Italy) in 1971, the rhythm of one meeting every three years has been steadily maintained, which is an indication of the continuing interest in our field.

This book is the only published account of the meeting. It contains all the lectures and poster abstracts accepted by the scientific committee. The book was prepared before the meeting, in order to be a useful guide to the lectures and posters. Therefore, it may contain some lectures and posters that were not actually presented.

All texts have been edited if necessary to conform to a uniform format. Occasionally evident typing and language errors have been corrected. Otherwise the texts are printed as submitted by the authors, who remain responsible for the published data and information.

The lectures and posters are classified into seven sections:

1. Invited lectures
2. Genetic resources
3. Breeding programs and strategies
4. Physiology and quality
5. Diseases and resistance
6. Biotechnology
7. Genome analysis

In each section the lectures appear first, followed by the poster abstracts in alphabetical order of first author.

In comparison with previous meetings, the number of reports dealing with genomics is again increased. These reports can be found in several sections, as the relevance of genomics to other fields is becoming more evident. The section on Genome analysis is mostly devoted to new technologies and to genomics results that don't fit well in other sections.

We sincerely hope that this meeting will again stimulate the exchange of ideas and be an inspiration to breeders and scientists worldwide, working in the field of *Capsicum* and Eggplant breeding and genetics.

Roeland Voorrips,
on behalf of the Organizing and Scientific Committees

CONTENTS

INVITED LECTURES.....	15
Plants ‘cry for help’: Opportunities for integrating plant breeding and biological control	
<i>Dicke M.</i>	16
Optimal methods of using marker information in gene introgression and gene pyramiding programs	
<i>Frédéric Hospital, Bertrand Servin, Olivier C. Martin, Marc Mézard</i>	24
GENETIC RESOURCES.....	31
<i>Lectures</i>	
The taxonomic answer to the species dilemma in <i>Capsicum chinense</i> and <i>C. frutescens</i>: a key issue for <i>Capsicum</i> improvement and conservation genetics	
<i>Paul W. Bosland, Jit B. Baral</i>	32
Spanish traditional varieties of eggplant: diversity and interest for plant breeding	
<i>J. Prohens, J. M. Blanca, A. Rodríguez-Burruezo, F. Nuez</i>	38
Assessment of genetic relationships in the genus <i>Capsicum</i> using different DNA marker systems	
<i>Kochieva E.Z., Ryzhova N.N., van Dooijeweert W., Boukema I.W., Arens P.</i>	44
<i>Posters</i>	
Collection and Characterization of <i>Capsicum annum</i> (Sweet pepper) in Nigeria	
<i>O.A. Adetula and J.O. Babatola</i>	51
Genetic variability studies in Chilli (<i>Capsicum annum</i> l.)	
<i>N. Basavaraja, R.M. Hosamani and Krishna. C. Ukkund</i>	52
Characterization of different pepper genotypes collected from coastal regions of Turkey	
<i>Davut Keles, Suleyman Karagul, Saadet Buyukalaca</i>	53
Genetic diversity among <i>Capsicum chinense</i> Jacq. accessions revealed by different molecular marker systems	
<i>Kochieva E.Z., Ryzhova N.N., van Dooijeweert W., Boukema I.W., Arens P.</i>	54
Amplified fragment length polymorphism (AFLP) for genetic diversity assessment in Italian sweet pepper (<i>Capsicum annum</i> L.) germplasm	
<i>G. Nervo, E. Portis, L. Barchi and S. Lanteri.....</i>	55
Genetic resources of eggplant (<i>solanum melongena</i> l.) and their utilization in India	
<i>Mathura Rai, Major Singh and Sanjeet Kumar</i>	56

<i>Solanum melongena</i> (Eggplant) - A possible interspecific origin <i>V. Rattan Kumar, Y.V. Rao and B.G.S. Rao</i>	57
Germplasm collection eggplant and pepper genetic resources in Armenia <i>K.M. Sarikyan</i>	58
Current state of the collection of pepper (<i>Capsicum annuum L.</i>) in Gene Bank Olomouc, RICP Prague <i>Helena Stavěliková</i>	59
The CGN <i>Capsicum</i> (Pepper) and non-tuber bearing <i>Solanum</i> (eggplant) collections <i>Willem van Dooijeweert and Ietje Boukema</i>	60
Studies on electrophoresis on interspecific hybrids of eggplant <i>Warade S. D., Sanap P.B., Patil R.S., Bhalekar M.N. and Gupta N.S.</i>	61
Morphological evaluation of <i>Capsicum</i> germplasm using statistic analysis <i>Young Chae, J-C Shieh, J-B Park and L.M. Engle</i>	62
Genetic resources of pepper (<i>capsicum annuum l.</i>) in Serbia <i>B. Zecevic, M. Mijatovic, R. Djordjevic and D. Cvikic</i>	63
BREEDING PROGRAMS AND STRATEGIES	65
Lectures	
Performance of phenotypic selection for a polygenic trait : QTL conservation and loss across the cycles of selection of pepper for resistance to <i>Phytophthora capsici</i> <i>Alain Palloix, Ganaëlle Bernard, Arnaud Thabuis, Anne-Marie Daubèze, Thérèse Phaly, Patrick Signoret, Véronique Lefebvre</i>	66
Results of three cycles of marker-assisted backcross in pepper for resistance QTLs to <i>Phytophthora capsici</i> <i>Véronique Lefebvre, Arnaud Thabuis, Bertrand Servin, Anne-Marie Daubèze, Patrick Signoret, Frédéric Hospital, Alain Palloix</i>	73
Studies on interspecific hybridization in eggplant (<i>Solanum melongena L.</i>) for little leaf disease resistance <i>S.D. Warade, P.B. Sanap, D.M. Sawant and N.S. Gupta</i>	79
Posters	
Evaluation of Chilli (<i>capsicum annuum l.</i>) genotypes for variability, path analysis and genetic divergence under high temperature <i>M.N. Bhalekar, S.N. Dutonde, N.S. Gupta, S.D. Warade</i>	84
A new once-over harvest-type varieties 'Saeng-ryeog no. 211' and 'Saeng-ryeog no. 213' in red pepper (<i>capsicum annuum L.</i>) <i>M.C. Cho, D.H. Pae, Y.S. Cho, Y. Chae, W.M. Lee, D.H. Kim, Y.H. Om, D.S. Kim, S.R. Cheong, I.G. Mok, J.Y. Yoon</i>	85
Genetic analysis of dry fruit yield, fruit quality and pest resistance in Chilli (<i>Capsicum annuum L.</i>) <i>R.C. Jagadeesha, N. Basavaraja, Ravi Hunje</i>	86

Earliness as an important trait of field grown pepper (<i>Capsicum annuum</i> L.) in Central and Northern Europe <i>A. Korzeniewska and K. Niemirowicz-Szczytt</i>	87
Male sterility research at iivr and a success story with <i>ms-10</i> gene in hot pepper (<i>Capsicum annuum</i> L.) <i>Sanjeet Kumar, Major Singh and Mathura Rai</i>	88
Capsicum: cost effective hybrid seed production <i>N. Nagy, N.F. Derera and P.J. Sharp</i>	89
Genetic divergence and development of hybrids in bell pepper <i>Nandadevi and P. R. Dharmatti</i>	90
Development of eggplant functional male sterile lines and its utilization <i>Tian Shibing, Wang Yongqing, Liu Fuzhong, Luo Zhangyong, Pi Wei, Chen Yikang, Liu Junshao</i>	91
Combining ability analysis of Eggplant functional male sterile lines and restorers <i>Tian Shibing, Wang Yongqing, Luo Zhangyong, Pi Wei, Chen Yikang, and Liu Junshao</i>	91
Evaluation of Chilli (<i>Capsicum annuum</i> L.) hybrids for yield and quality characters <i>Daljeet Singh, J.S. Hundal, D.S. Khurana, T.S. Dhillon, Neena Chawla and Sampuran Kaur</i>	92
Evaluation of elite material of brinjal and their hybrids <i>J.C. Thakur, Daljeet Singh, S.S. Bal, A.S. Sidhu and T.S. Dhillon</i>	93
The creation of sweet pepper hybrids tolerant to biotic and abiotic stressors and improved biochemical composition of fruits <i>Timina O.O., Timin O.Y., Daskalov S., Alekseev Y.B., Ignatova S.I.</i>	94
Hungarian pepper varieties grown on rockwool <i>D. Tompos, J. Gyúró</i> s.....	95
Earliness and high yield cultivar model breeding in hot pepper (<i>Capsicum annuum</i> L.) <i>Deyuan Wang and Ming Wang</i>	96
Verticillium wilt resistance and cytoplasmic male sterility in progenies of eggplant rootstock variety, ‘Taibyo VF’ <i>T. Yoshida, H. Matsunaga, T. Saito, T. Yamada and A. Saito</i>	97
New rootstock ‘Eggplant Ano 2’ with highly resistance to bacterial wilt and fusarium wilt <i>T. Yoshida, S. Monma, H. Matsunaga, Y. Sakata, T. Sato, T. Saito, A. Saito and T. Yamada</i>	98

PHYSIOLOGY AND QUALITY99

Lectures

Genetics of pungency from phenotype to genotype and back to phenotype

A. Ben-Chaim, M. Falise, Y. Borovsky, M. Mazourek, C. Stewart, M. Taranto, K. Liu, M. Kreitinger, I. Paran and M. Jahn100

Search for low temperature tolerant *Capsicum* accessions to conserve energy in greenhouse pepper production

Erik A.M. de Swart, Leo F.M. Marcelis, Roeland E. Voorrips101

Eggplant (*Solanum melongena*) fruit colour: pigments, measurements and genetics

Marie-Christine Daunay, Serge Aubert, Anne Frary, Sami Doganlar, Richard N. Lester; Gerard Barendse, Gerard van der Weerden, Jean-Winoc Hennart, Jair Haanstra, François Dauphin; Evelyne Jullian108

Incomplete anthocyaninless mutations in *Capsicum annum* l. X C. *chinense* jacq. hybrids

Roumiana Pandeva117

Posters

Phenotypic correlation between capsaicin and dihydrocapsaicin contents in *Capsicum annum*

Garcés Claver A., Arnedo Andrés M.S., González C. and Gil Ortega R.121

Comparison of *S. melongena* ‘MM 738’ and *S. linnaeanum* ‘MM 195’ for salinity resistance

Daunay M.C., S. Adamowicz, J. Le Bot, J. Hostalery, J. Fabre122

Colour retention in export oriented Indian Chillies (*Capsicum annum* L.) as affected by ripening stage

M. Kalpana and M.B. Chetti123

Evaluation of Paprika (*Capsicum annum* var. *longum*) cultivars for processing

S. Padmapriya, N. Chezhiyan and S. Subramanian.....124

Studies on the breeding behaviour of the Chilli (*Capsicum annum* L.) parents and hybrids in capsaicin synthesis

V. A. Sathiyamurthy, D. Veeraragavathatham and V. Sankar.....125

Studies on the capsaicin biosynthesis of Chilli (*Capsicum annum* L.) hybrids with high pungent for processing industry

V. A. Sathiyamurthy, D. Veeraragavathatham, M. Jawaharlal, K. Rajamani and K. R. Rajadurai.....126

Isoenzyme studies in capsaicin metabolism of Chilli (*Capsicum annum* L.) hybrids

V. A. Sathiyamurthy, D. Veeraragavathatham and V. Sankar.....127

Seedlessness as a physiological parameter for enhanced pungency principle, a pharmaceutically useful quality trait, in *Capsicum*

G.K. Satpute, Neeta-Sharad Dodke, Tishyarakshita and R.G. Satpute128

Genetic analysis of Parthenocarpy in Eggplant <i>Tian Shibing, Liu Fuzhong, Wang Yongqing, Luo Zhangyong, Chen Yikang, Liu Junshao and Hong Yunju</i>	129
Salt tolerance of sweet pepper varieties <i>K. Slezak, I. Terbe, N. Kappel and K. Tóth</i>	130
Sucrose synthase and acid invertase activity in relation to the floral structures abortion in pepper (<i>Capsicum annuum</i> L.) grown under low night temperature <i>N. Tarchoun, M. Bodson and A. Mougou</i>	131
Legumins in pepper (<i>Capsicum annuum</i> L.) and eggplant (<i>Solanum melongena</i> L.) cultivars <i>R. Vladova , V Tsanev, K. Petcolicheva and M. Zamfirova</i>	132
DISEASES AND RESISTANCE	133
<i>Lectures</i>	
New genes related to PVY resistance in <i>C. annuum</i> L. ‘Serrano Criollo de Morelos-334’ <i>M.S. Arnedo Andrés, M. Luis Arteaga and R. Gil Ortega</i>	134
PVY evolution toward virulence to the resistance conferred by <i>pvr2</i>³ in pepper and consequences for its durability <i>Valérie Ayme, Olivier Pierrugues, Sylvie Souche, Ghislaine Nemouchi, Carole Caranta, Mireille Jacquemond, Joël Chadoeuf, Alain Palloix, Benoît Moury</i>	139
The unity of plant defense: Genetics, breeding and physiology <i>Gabor Csillery, Eszter Szarka, Eva Sardi, Judit Mityko, Jozsef Kapitany, Barbara Nagy, Janos Szarka</i>	147
Heredity of <i>Tomato mosaic virus</i> (ToMV) and <i>Potato virus Y</i> (PVY) resistance in eggplant (<i>Solanum melongena</i> L.) <i>Marie-Christine Daunay, Carole Caranta, Frédérique Pédrón, Chrystel Deulvot, Marie-Hélène Dussault, André Moretti, Evelyne Jullian, Sandrine Ruffel, Frédéric Moquet, Mansour Majde, Kahsay Gébré Selassié, Patrick Gognalons, Georges Marchoux</i>	154
Fine-mapping of a quantitative resistance locus to <i>Phytophthora</i> spp. and development of NIL-QTLs in pepper <i>Véronique Lefebvre, Julien Bonnet, Christine Boudet, Marianne Hédont, Patrick Signoret, Thérèse Phaly, Anne Blattes, Sarah Danan, Alain Palloix</i>	161
Involvement of the eukaryotic translation initiation factor eIF4E in <i>Solanaceae-Potyvirus</i> interactions <i>Sandrine Ruffel, Marie-Hélène Dussault, Marie-Laure Lesage, André Moretti, Alain Palloix, Marie-Christine Daunay, Benoît Moury, Abdel Bendahmane, Christophe Robaglia, Carole Caranta</i>	167
Molecular characterization and genetic variability of Chilli Veinal Mottle Virus and its reaction on chilli pepper genotypes <i>Krishna Reddy M., Madhavi Reddy K., Lakshminarayana Reddy C. N., Smitha R., Jalali S.</i>	171

Posters

Improvement of eggplants for resistance to <i>Verticillium</i> <i>Acciarri N., Rotino G.L., Sabatini E., Valentino D., Sunseri F., Mennella G., Tamietti G.</i>	178
Infection of Chili Veinal Mottle Virus(ChiVMV) is not affected by temperature <i>M.C. Cho, S. C. Shieh, P.A. Gniffke, S. K. Green, D.H. Pae</i>	179
Genetic, cytological and molecular bases of the resistance to root-knot nematodes (<i>Meloidogyne</i> spp.) in pepper (<i>Capsicum annuum</i> L.) <i>Djian-Caporalino C., Berthou F., Fazari A., Lefebvre V., Palloix A., Pegard A., Pijarowski L.</i>	180
Evaluation of differential interactions between <i>Phytophthora capsici</i> Leonian isolates and some pepper (<i>Capsicum annuum</i> L.) genotypes <i>Gocmen M., Cakir C., Abak K.</i>	181
Typing of tomato yellow leaf curl virus spreading on pepper in Tunisia <i>F. Gorsane, I. Fekih-Hassen, S. Gharsallah-Chouchene, M.K. Nakhla, D. P. Maxwell, M. Marrakchi and H.Fakhfakh</i>	182
Determination of the inheritance of resistance to bacterial wilt (<i>Ralstonia solanacearum</i>) in eggplant (<i>Solanum melongena</i> L.) <i>Gousset C, Lian Yong, Mariska I, Rotino G, Seaves A, Sihachakr D.....</i>	183
High levels of resistance to bacterial (<i>Ralstonia solanacearum</i>) and fungal (<i>Fusarium oxysporum</i>) wilts and genetic homogeneity in Indonesian accessions of <i>Solanum torvum</i>, a wild relative of eggplant <i>Gousset C, Karden M, Mariska I, Rotino G, Servaes A, Sihachakr D</i>	184
Evaluation of <i>Phytophthora</i> and <i>Ralstonia</i> multiple resistance selections of pepper for adaptability as rootstocks <i>B.S. Kim and J.H. Kim</i>	185
Reaction of different <i>Capsicum</i> genotypes to Tobamoviruses and Cucumber mosaic virus <i>J. Kovács R. Gáborjányi, J. Horváth, G. Kazinczi and A.P. Takács.....</i>	186
Diseases of pepper in Serbia and results of breeding for resistance <i>M. Mijatovic, B. Zecevic, D. Cvikic and A. Obradovic.....</i>	187
Incidence of powdery mildew on pollen viability of <i>Capsicum</i> <i>Nandadevi and P. R. Dharmatti</i>	188
QTL mapping of Anthracnose (<i>Colletotrichum capsici</i>) in Chilli <i>P. Pakdeevaporn, S. Wasee, P. Taylor and O. Mongkolporn</i>	189
Resistance of <i>Capsicum annuum</i> L. lines to Chilli Veinal Mottle Potyvirus isolate, inheritance and allelism studies for resistance genes <i>K. Madhavi Reddy, M. Krishna Reddy, C. N. Lakshminarayana Reddy and A. T. Sadashiva</i>	190
Genetics of resistance to Cucumber Mosaic Virus (CMV) in sweet pepper (<i>Capsicum annuum</i> L.) <i>T. Saito, T. Yoshida, A. Saito and T. Yamada</i>	191

Identification of stable sources of resistance to bacterial wilt (<i>Ralstonia solanacearum</i>) in eggplant (<i>Solanum melongena</i> L.) <i>T.H. Singh, A.T. Sadashiva, K. Madhavi Reddy, M.V. Balaram, L.R. Naveen and K. Krishna Murthy</i>	192
Two linked QTLs determine most of the variation for anthracnose (<i>Colletotrichum gloeosporioides</i>) resistance in a <i>Capsicum annuum</i> x <i>C. chinense</i> cross <i>Roeland E. Voorrips, Richard Finkers, Lia Sanjaya, Remmelt Groenwold</i>	193
BIOTECHNOLOGY	195
<i>Lectures</i>	
Management of resistance to Coleoptera (<i>Leptinotarsa decemlineata</i> – Say) in transgenic eggplant (<i>Solanum melongena</i> L.) hybrids <i>Mennella G., D’Alessandro A., Arpaia S., Acciarri N., Sunseri F., Rotino G.L.</i>	196
Production and utilization of sexual “double hybrid” between the somatic hybrids <i>S. melongena</i> (+) <i>S. integrifolium</i> and <i>S. melongena</i> (+) <i>S. aethiopicum</i> gr. <i>Gilo</i> <i>Rotino G.L., Rizza F., Mennella G., Tacconi M.G., Alberti P., D’Alessandro A., Acciarri N., Toppino L.</i>	203
Molecular analysis of interspecific graft-induced variation in pepper (<i>Capsicum</i>) <i>Shiiguchi K., Ajiro T., Zhung Y., Cui S., and Hirata Y.</i>	210
<i>Posters</i>	
Molecular analysis of Graft-Induced Variant Strain in Pepper (<i>Capsicum annuum</i> L.) <i>T.Ajiro, Y.Hirata, S.Ogata, K.Shiguchi and S.Cui</i>	216
Factors affecting the in vitro organogenesis efficiency of Tunisian pepper and biolistic transformation essay <i>S.Arous, M.Boussaïd and M. Marrakchi</i>	217
Optimization of <i>Agrobacterium</i>-mediated genetic transformation of pepper (<i>Capsicum annuum</i> L.) <i>M. Delis, A. Nadolska-Orczyk and K. Niemirowicz-Szczytt</i>	218
Studies on the in vitro androgenesis in Chillies (<i>Capsicum annuum</i> L.) <i>Jasmine, J.A.P., S. D. Paulas and S. Thamburaj</i>	219
A new selection method for pepper transformation: Callus-Mediated Shoot Formation <i>Y.H. Lee, H.S. Kim, J.Y. Kim, M. Jung, Y.S. Park, J.S. Lee, S.H. Choi, N.H. Her, J.H. Lee, N.I. Hyung, C.H. Lee, S.G. Yang and C.H. Harn</i>	220
Effect of selection for increased seed set and meiotic behaviour in colchicine induced autotetraploid chili pepper (<i>Capsicum annuum</i> L.) <i>V. Rattan Kumar, O. Anil Kumar, Y. Venkateswara Rao* and K.G. Raja Rao</i>	221

GENOME ANALYSIS	223
<i>Lectures</i>	
Occurrence and polymorphism of microsatellite repeats in the sequence databases in pepper	
<i>István Nagy, Zsuzsanna Sasvári, Anikó Stágel, Sándor Ács, Gyöngyi Bárdos</i>	224
Construction of a new interspecific genetic map in pepper based on AFLP and microsatellite markers	
<i>Zsuzsanna Sasvári, Gyöngyi Bárdos, Sándor Ács, Anikó Stágel, István Nagy</i>	227
An integrated approach of mapping, BAC library and candidate gene cloning for chili molecular breeding	
<i>Byung-dong Kim, Je-Min Lee, Eun-Young Yoo, Dong-Hwan Kim.....</i>	232
Comparative QTL mapping of fruit weight and shape in pepper and tomato	
<i>Ilan Paran, Arnon Ben Chaim, Shachar Ziger, Yelena Borovsky, G.U. Rao and Dani Zamir</i>	239
Comparative genetics and genomics of disease resistance in the Solanaceae	
<i>Byoung-Cheorl Kang, Michael Mazourek, Liz Cerulli, Ed Quirin and Molly Jahn</i>	246
<i>Posters</i>	
SNPs development in pepper	
<i>A. Acquadro, P. Donini, D. Lee, C. Comino, E. Portis and S. Lanteri.....</i>	247
The A locus that controls anthocyanin accumulation in pepper encodes a MYB transcription factor homologous to <i>Anthocyanin2</i> of <i>Petunia</i>	
<i>Y. Borovsky, M. Oren-Shamir, R. Ovadia, W. De Jong and I. Paran.....</i>	248
Hybrid identification with microsatellite markers	
<i>Gémes Juhász A, Stágel A, Zatykó L, Nagy I.....</i>	249
Identification of a mitochondrial gene associated with cytoplasmic male sterility (cms) in pepper (<i>Capsicum annuum</i> L.)	
<i>D.H. Kim, B.D. Kim</i>	250
Development of microsatellite markers in eggplant	
<i>T. Nunome, I. Kono, N. Namiki, H. Kanamori, K. Suwabe, A. Ohyama, H. Fukuoka.....</i>	251
RAPD Analysis of Cytoplasmic Male Sterile Gene in hot pepper (<i>Capsicum annuum</i> L)	
<i>Deyuan Wang, Qiumiao Yin, and Ming Wang.....</i>	252

AUTHOR INDEX253

LIST OF PARTICIPANTS.....257

INVITED LECTURES

Plants ‘cry for help’: Opportunities for integrating plant breeding and biological control.

Dicke M.

Laboratory of Entomology, Wageningen University, P.O. Box 8031, NL-6700 EH Wageningen, The Netherlands, e-mail: marcel.dicke@wur.nl

Abstract: Plants are endowed with two major defences against their herbivorous enemies: direct defence aimed at their attacker directly and indirect defence that acts through enhancing the effectiveness of the enemies of plant attackers. Components of the latter plant defence improve the effectiveness of biological control, a method of pest control that employs arthropod predators and parasitoids that feed on the herbivores. Biological control has proven to be a valuable control strategy that may be integrated with plant breeding to obtain an environmentally benign strategy of pest control.

The indirect defence of plants that enhances the mortality of herbivores through their natural enemies is induced by herbivory and has a genetic basis. Therefore, plant breeders may develop cultivars with an enhanced indirect defence, just as cultivars have been developed with an enhanced direct defence. To be able to breed for cultivars that have an enhanced indirect defence, novel tools such as genetic expression markers may be developed. In this paper I will give an overview of indirect induced plant defence and its potential for plant breeders.

Introduction

Plants can very well defend themselves against their attackers. Although they are rooted and cannot run away from their enemies, they have an extensive array of defensive strategies. These can be divided into two main categories: (1) direct defence in which plants combat their enemies through characteristics that negatively affect the herbivore directly, or (2) indirect defence in which they enhance the effectiveness of natural enemies of the herbivores. Humans have exploited these two ways of plant defence to develop two methods of environmentally-benign pest control: host plant resistance and biological control. Biological control aims at keeping the pest organisms under the damage threshold through the use of natural enemies of the herbivores, such as parasitoids and predators. Breeding for resistance aims at the selection of plant cultivars on which pest organisms cannot develop population sizes above the damage threshold. Breeding for resistance often tries to reach absolute resistance, which implies that the crop cultivars do not sustain herbivores at all. However, just as pest species can become resistant to synthetic pesticides, so too can they develop resistance to plant cultivars. Basically, the stronger the resistance of the host plant to the herbivore, the stronger the selection pressure on the pests to develop resistance. Therefore, plant breeders should ideally develop partially resistant cultivars. In the past, pest control strategies often combined resistant cultivars with pesticide applications. However, environmentally benign pest control should integrate resistant cultivars with biological control. Although it was often considered that the two control strategies are synergistic, this is not *a priori* obvious. Plant characteristics not only affect herbivores, but they may also affect natural enemies of herbivores that live on or visit the plant. This latter aspect has become well documented in the past 25 years (e.g., Bottrell et al., 1998; Dicke, 1999a; Price et al., 1980). Therefore, changes in plant characteristics through breeding for resistance to herbivores are likely to result in changes in the way plants affect the natural enemies. Strikingly, in an analysis of all published studies on interaction among host plant

resistance and biological control, Hare (1992) found that out of 16 cases only two showed synergism, while in six cases antagonism among the two control strategies was found.

Political developments towards a reduction of pesticide application lead to more and more situations where host plant resistance and biological control are to be integrated. For such an integration to be successful, studies are needed on the overall effect of the integration. Otherwise plant breeding programmes may result in a pest control programme that is less rather than more effective (see Van Emden 1986 for an example). Obviously, antagonism is not only unwanted in individual cases but will also hamper the stimulation of new developments in environmentally benign pest control.

Plant characteristics that affect natural enemies of herbivores

Plants can affect carnivores in various ways, either independently of the herbivore or mediated by the herbivore. Most information is available on the following plant features: (1) plant morphology (2) plant products that are used as food by carnivores, (3) plant volatiles, and (4) plant toxins and digestibility reducers (Dicke, 1999a).

Plant morphology

Many plant morphological features, such as cuticle thickness, glandular and non-glandular trichomes and plant architecture have been used in plant breeding programmes to select for cultivars that are less susceptible to herbivores (e.g. Panda & Khush, 1995). However, also carnivorous arthropods that move over the plant's surface are affected by changes in plant morphology, either positively or negatively (Eigenbrode & Espelie, 1995; Krips et al., 1999; Roda et al., 2000; Van Lenteren & De Ponti, 1990). Plant structures such as domatia (Greek for 'little rooms') are well-known to provide structural protection to carnivores (Agrawal & Karban, 1997; Jacobs, 1966; O'Dowd & Willson, 1991). Trichomes can impede carnivore foraging behaviour (Krips et al., 1999; Van Lenteren & De Ponti, 1990). Knowledge about plant morphology hampering natural enemy movement has been employed to improve control of greenhouse whitefly (*Trialeurodes vaporariorum*) with the parasitoid *Encarsia formosa* on cucumber (Van Lenteren & De Ponti, 1990). On commercial cultivars trichomes strongly impeded movement of the parasitoid. In a breeding programme, Van Lenteren & de Ponti (1990) used a hairless cucumber variety and obtained a half-haired cucumber hybrid by crossing this with commercial, haired varieties. Hairiness was determined by one dominant gene with intermediary inheritance. On the hairless variety the parasitoids moved so fast that they ran over the whitefly larvae without noticing them, but on the half-haired variety they had a walking speed twice that on the haired variety, which resulted in higher encounter rates with host larvae. In greenhouse experiments the performance of the parasitoids was better on half-haired hybrids than on a commercial, haired variety, yielding a satisfactory level of control. The seed of the half-haired hybrid has been made available for commercial application by breeding companies.

Plant products that are used as food by carnivores

Carnivores can use various plant tissues and plant products, such as floral and extrafloral nectar, plant sap, and pollen, as sources of nutrition (Koptur, 1992; Wackers, 2004). This may result in prolonged presence or long-term arrestment of carnivores on the plant during periods of herbivore absence. Often this is additional to provision of shelter to carnivores.

Plant volatiles

Carnivorous arthropods have to find their arthropod prey, small units in a complex three-dimensional world. In doing so, carnivorous arthropods depend on chemical cues to find

their victims. These cues may originate from intact food plants or from their herbivorous prey. However, the most important chemical information is disseminated by plants that are damaged by herbivorous arthropods (Dicke & Vet, 1999; Vet & Dicke, 1992). In response to herbivory, or even in response to oviposition by herbivorous arthropods, plants emit induced volatiles that attract carnivorous enemies of the herbivores (Hilker & Meiners, 2002; Turlings et al., 1995; Vet & Dicke, 1992). This plant response has sometimes been designated a 'cry for help'. Extensive knowledge has been obtained on this form of induced plant defence, including the biosynthesis of the cues and gene induction involved (Bouwmeester et al., 2003; Bouwmeester et al., 1999; Degenhardt et al., 2003; Paré & Tumlinson, 1997). This form of induced plant defence is common among plant species: it has been reported for plants from more than 13 families (Dicke, 1999b), including solanaceous plants such as tomato, potato and eggplant (Bolter et al., 1997; Dicke et al., 1998; Thaler et al., 2002; Van den Boom et al., 2004) and has recently also been reported for the model plant of molecular genetics, *Arabidopsis thaliana* (Van Poecke & Dicke, 2003; Van Poecke et al., 2001).

Plant toxins and digestibility reducers

Plant secondary chemicals that affect herbivore performance are many and herbivores may have evolved ways of overcoming their effects. One of these is that herbivores may sequester toxic plant compounds with the consequence that natural enemies are affected once they attack these herbivores. There are many examples for interference of plant secondary chemicals with predators, parasitoids and pathogens of herbivores e.g. (Krischik et al., 1988; Rowell-Rahier & Pasteels, 1992).

On the other hand, digestibility reducers lead to decelerated development, which may result in prolonged exposure to natural enemies in certain vulnerable stages and thus in enhanced effectiveness of natural enemies e.g. (Loader & Damman, 1991; Price et al., 1980).

Volatile carnivore attractants and plant breeding

Every insect herbivore that is a pest has a large number of arthropod enemies ranging from insect predators and parasitoids to predatory spiders and mites. These carnivorous arthropods often accomplish natural control of herbivorous insects. In other cases farmers can deliberately release the carnivorous enemies as biological control agents, both in greenhouse crops and in open field crops (DeBach, 1974). Knowing that plant volatiles are important cues for the carnivores to locate the pest insects and knowing that the emission of volatiles varies among genotypes (Bouwmeester et al., 2003; Elzen et al., 1985; Gouinguene et al., 2001). In a study of cotton, (Elzen et al. 1985) reported more than a 100-fold difference between different cultivars in the emission of volatile terpenes that attract the parasitoid *Campoletis sonorensis*. That differences in the amount of plant-produced parasitoid attractants can decisively affect pest control was demonstrated in a field study of cabbage-aphid-parasitoid interactions (van Emden, 1986). More aphids (*Brevicoryne brassicae*) were found on a 'resistant' cultivar than on a 'susceptible' cultivar, when parasitoids (*Diaeretiella rapae*) were present. Van Emden showed that the susceptible cultivar, which produced significantly more (2.4 times) of the parasitoid attractant allyl isothiocyanate, was significantly preferred by the parasitoids and had significantly more mummified aphids than the resistant cultivar. This is one of the few examples where the effect of plant volatiles has been investigated in the field and the laboratory. It shows that the terms 'susceptible' and 'resistant' are context specific and that plant breeding practices may be counterproductive if the effect of carnivores is not taken into consideration.

Herbivore-induced plant volatiles seem to be the most important cues that guide carnivorous arthropods to their herbivorous victims (Vet & Dicke, 1992). Given that their emission varies among cultivars (Dicke et al., 1990; Gouinguene et al., 2001; Krips et al.,

2001; Loughrin et al., 1995), this knowledge may be exploited to breed for cultivars that emit large amounts of volatiles in response to herbivory and thus guide biological control agents better to the locations where herbivorous insects are present. This process may be time-consuming when the selection has to be made based on the phenotype in terms of volatile emission (Gouinguene et al., 2001) or carnivore attraction (Krips et al., 2001). However, when sufficient knowledge is gained on the genes involved in the biosynthesis of the major carnivore attractants (Bouwmeester et al., 2003), expression markers may be developed that can be used to make progress much faster. This asks for investigations at the gene expression level and important progress has already been made with plants such as *Arabidopsis* and potato (Bouwmeester et al., 2003; Van Poecke et al., 2001). Research along this line is likely to provide plant breeders with novel tools in the near future.

Implications for future selection programs

A wide variety of plant attributes appears to influence the effect of carnivores on herbivore populations. From an applied perspective this may seem to yield a rather confusing situation: for a successful integration to occur between breeding host plants for resistance and selecting natural enemies for biological control one needs to screen all possible interactions between plants and natural enemies. Although it is valuable to have all this knowledge, it is evidently impractical to obtain all this information before integration of plant breeding and biological control can be started. Thus, priorities must be set. The major lesson to be learned is that although host plant resistance and biological control can be synergistic it is not self-evident that this is the case (van Emden, 1986). Thus, both plant breeders and entomologists should take into consideration the constraints of each other's practices where integration of host-plant resistance and biological control is to be achieved, either intentionally or implicitly.

In order to make a well-based prediction, collaborative studies should be carried out, that take into consideration the most important pests in a certain crop and the most important plant characteristics affecting natural enemies that have potential for biological control of these pests. In the case of selecting cultivars that are best suitable for biological control the following aspects should be taken into account: (a) the effect of different cultivars on the pest organism, (b) the effect of different cultivars on the beneficial organism and (c) the effect of different cultivars on the interaction of the beneficial with the pest organism. In the case of selecting natural enemies that are compatible with a certain plant cultivar this concerns: (a) which species of natural enemies are compatible with the most important plant trait affecting the carnivores, (b) is it possible to select within a carnivore species for genotypes that are better suited on the cultivar or crop plant under investigation and (c) is the performance of such selected carnivore species or genotypes in the interaction with the pest organism satisfactory? Only through an integrated selection procedure an optimal integration of host plant resistance and biological control can be reached.

The scenario depicted above still involves a large amount of research and several pitfalls may be encountered when taking this path. For instance, during breeding for resistance against one herbivore species increased susceptibility against another species may arise. Analogously, there is a risk that selection for a characteristic that favors one species of beneficial organism interferes with the effectiveness of another beneficial species. Yet, these are the risks that are inherent to plant breeding. When investing in a program to integrate partial host plant resistance with biological control, this will lead to prolonged use of a resulting cultivar because of the slower rate of herbivore adaptation (Gould et al., 1991). Because of potential interference with other herbivore-natural enemy interactions it is most profitable to start with projects that deal with crop plants that have relatively few pest species and where much knowledge exists on the biological control agents that are used to control these pests. This would favor starting with greenhouse crops, because biological control in greenhouses is well-established, much knowledge exists on the

biological control agents and the number of pests is relatively low compared to outdoor crops or perennial systems such as fruit orchards. The first example that has yielded success actually relates to a greenhouse system: cucumber-greenhouse whitefly-*Encarsia formosa* (Van Lenteren & De Ponti, 1990).

Finally, an approach that yields application in the shortest period of time is to use the empirical method. If a characteristic is known that improves the effectiveness of a biological control agent, this may be tested under agricultural conditions. If successful for the beneficial organism under consideration while no negative effects are observed for other beneficial species, the characteristic may be incorporated into management programs. Subsequent steps will be to intensify research according to the lines depicted above, in order to increase understanding of how, why and when this aspect is important in the multitrophic system under consideration. In doing so, future programs may be developed more efficiently.

Conclusions

Host plant resistance and biological control are highly valuable components of environment-friendly pest control. However, these two components are not *a priori* compatible. The biological control agents are active on the plant and are thus affected by a wide range of plant traits that can influence their effectiveness either directly or through interactions with the pest organism. In order to develop an integrated pest management program that incorporates both methods of pest control, we should consider how the crop affects the beneficial organisms. Ideally we should incorporate the impact of plants on beneficial organisms both in selection procedures that select for the best plant cultivar for agriculture and in selection procedures that select for beneficial organisms that are most suitable for biological control of pest organisms. It is important to keep in mind that in doing so, we are likely to be forced to set priorities. Not all combinations of traits, either in the plant or in the beneficial organism may be biologically realistic. For instance, some plant species may have invested considerably in direct defence rather than in indirect defence, i.e. via natural enemies of herbivores. In crop plants originating from such plants, there may be more possibilities of modifying plant traits that directly affect the herbivore than of traits that indirectly affect the herbivore through its natural enemies. Although the notion that plant traits may decisively influence the effectiveness of beneficial organisms is a recent one, some studies have already shown that it is very possible to exploit this knowledge and to expand the employment of environmentally-benign pest control. These studies show that cooperation of plant breeders and entomologists can lead to innovative new developments in environmentally sound pest control.

References

- Agrawal, A.A. & Karban, R. (1997) Domatia mediate plant-arthropod mutualism. *Nature*, 387, 562-563.
- Bolter, C.J., Dicke, M., van Loon, J.J.A., Visser, J.H., & Posthumus, M.A. (1997) Attraction of Colorado potato beetle to herbivore damaged plants during herbivory and after its termination. *Journal of Chemical Ecology*, 23, 1003-1023.
- Bottrell, D.G., Barbosa, P., & Gould, F. (1998) Manipulating natural enemies by plant variety selection and modification: A realistic strategy? *Annual Review of Entomology*, 43, 347-367.
- Bouwmeester, H.J., Kappers, I.F., Verstappen, F.W.A., Aharoni, A., Luckerhoff, L.L.P., Lückner, J., Jongasma, M.A., & Dicke, M. (2003) Exploring multi-trophic plant-

- herbivore interactions for new crop protection methods. In International Congress of Crop Science and Technology, Vol. 2, pp. 1123-1134, Vol. 2, 10-12 November 2003, Glasgow, British Crop Protection Council, Alton, UK, pp 1123-1134.
- Bouwmeester, H.J., Verstappen, F., Posthumus, M.A., & Dicke, M. (1999) Spider-mite induced (3S)-(E)-nerolidol synthase activity in cucumber and Lima bean. The first dedicated step in acyclic C11-homoterpene biosynthesis. *Plant Physiology*, 121, 173-180.
- DeBach, P. (1974) *Biological control by natural enemies*. Cambridge, pp, 1-323.
- Degenhardt, J., Gershenzon, J., Baldwin, I.T., & Kessler, A. (2003) Attracting friends to feast on foes: engineering terpene emission to make crop plants more attractive to herbivore enemies. *Current Opinion in Biotechnology*, 14, 169-176.
- Dicke, M. (1999a). Direct and indirect effects of plants on performance of beneficial organisms. In *Handbook of Pest Management* (ed J.R. Ruberson), pp. 105-153. Marcel Dekker, New York.
- Dicke, M. (1999b). Evolution of induced indirect defence of plants. In *The Ecology and Evolution of Inducible Defenses* (eds R. Tollrian & C.D. Harvell), pp. 62-88. Princeton University Press, Princeton, NJ.
- Dicke, M., Sabelis, M.W., Takabayashi, J., Bruin, J., & Posthumus, M.A. (1990) Plant strategies of manipulating predator-prey interactions through allelochemicals: prospects for application in pest control. *Journal of Chemical Ecology*, 16, 3091-3118.
- Dicke, M., Takabayashi, J., Posthumus, M.A., Schütte, C., & Krips, O.E. (1998) Plant-phytoseiid interactions mediated by prey-induced plant volatiles: variation in production of cues and variation in responses of predatory mites. *Experimental and Applied Acarology*, 22, 311-333.
- Dicke, M. & Vet, L.E.M. (1999). Plant-carnivore interactions: evolutionary and ecological consequences for plant, herbivore and carnivore. In *Herbivores: Between Plants and Predators* (eds H. Olff, V.K. Brown & R.H. Drent), pp. 483-520. Blackwell Science, Oxford, UK.
- Eigenbrode, S.D. & Espelie, K.E. (1995) Effects of plant epicuticular lipids on insect herbivores. *Annual Review of Entomology*, 40, 171-194.
- Elzen, G.W., Williams, H.J., Bell, A.A., Stipanovic, R.D., & Vinson, S.B. (1985) Quantification of volatile terpenes of glanded and glandless *Gossypium hirsutum* L. cultivars and lines by gas chromatography. *Journal of Agricultural and Food Chemistry*, 33, 1079-1082.
- Gouinguene, S., Degen, T., & Turlings, T.C.J. (2001) Variability in herbivore-induced odour emissions among maize cultivars and their wild ancestors (teosinte). *Chemoecology*, 11, 9-16.
- Gould, F., Kennedy, G.G., & Johnson, M.T. (1991) Effects of natural enemies on the rate of herbivore adaptation to resistant host plants. *Entomologia Experimentalis et Applicata*, 58, 1-14.
- Hare, J.D. (1992). Effects of plant variation on herbivore-natural enemy interactions. In *Plant resistance to herbivores and pathogens : ecology, evolution, and genetics* (eds R.S. Fritz & E.L. Simms), pp. 278-198. Univ. Chicago Press, Chicago.
- Hilker, M. & Meiners, T. (2002) Induction of plant responses to oviposition and feeding by herbivorous arthropods: a comparison. *Entomologia Experimentalis et Applicata*, 104, 181-192.
- Jacobs, M. (1966) On domatia - The viewpoints and some facts. *Proceedings of the Royal Academy of Sciences, Amsterdam*, 69, 275-316.
- Koptur, S. (1992). Extrafloral nectary-mediated interactions between insects and plants. In *Insect-Plant Interactions* (ed E.A. Bernays), Vol. 4, pp. 81-129. CRC Press, Boca Raton, Florida.

- Krips, O.E., Kleijn, P.W., Willems, P.E.L., Gols, G.J.Z., & Dicke, M. (1999) Leaf hairs influence the searching efficiency and predation rate of the predatory mite *Phytoseiulus persimilis*. *Experimental and Applied Acarology*, 23, 119-131.
- Krips, O.E., Willems, P.E.L., Gols, R., Posthumus, M.A., Gort, G., & Dicke, M. (2001) Comparison of cultivars of ornamental crop *Gerbera jamesonii* on production of spider mite-induced volatiles, and their attractiveness to the predator *Phytoseiulus persimilis*. *Journal of Chemical Ecology*, 27, 1355-1372.
- Krischik, V.A., Barbosa, P., & Reichelderfer, C.F. (1988) Three trophic level interactions: allelochemicals, *Manduca sexta* (L.), and *Bacillus thuringiensis* var. *kurstaki* Berliner. *Environmental Entomology*, 17, 476-482.
- Loader, C. & Damman, H. (1991) Nitrogen content of food plants and vulnerability of *Pieris rapae* to natural enemies. *Ecology*, 72, 1586-1590.
- Loughrin, J.H., Manukian, A., Heath, R.R., & Tumlinson, J.H. (1995) Volatiles emitted by different cotton varieties damaged by feeding beet armyworm larvae. *Journal of Chemical Ecology*, 21, 1217-1227.
- O'Dowd, D.J. & Willson, M.F. (1991) Associations between mites and leaf domatia. *Trends in Ecology & Evolution*, 6, 170-182.
- Panda, N. & Khush, G.S. (1995) *Host Plant Resistance to Insects* CABI Intl., Wallingford, UK.
- Paré, P.W. & Tumlinson, J.H. (1997) De novo biosynthesis of volatiles induced by insect herbivory in cotton plants. *Plant Physiology*, 114, 1161-1167.
- Price, P.W., Bouton, C.E., Gross, P., McPheron, B.A., Thompson, J.N., & Weis, A.E. (1980) Interactions among three trophic levels: influence of plant on interactions between insect herbivores and natural enemies. *Annual Review of Ecology and Systematics*, 11, 41-65.
- Roda, A., Nyrop, J., Dicke, M., & English-Loeb, G. (2000) Trichomes and spider-mite webbing protect predatory mite eggs from intraguild predation. *Oecologia*, 125, 428-435.
- Rowell-Rahier, M. & Pasteels, J.M. (1992). Third trophic level influences of plant allelochemicals. In *Herbivores: their interaction with secondary plant metabolites*. Second edition (eds G.A. Rosenthal & M.R. Berenbaum), Vol. 2, pp. 243-277. Acad. Press, New York.
- Thaler, J.S., Farag, M.A., Pare, P.W., & Dicke, M. (2002) Jasmonate-deficient plants have reduced direct and indirect defences against herbivores. *Ecology Letters*, 5, 764-774.
- Turlings, T.C.J., Loughrin, J.H., McCall, P.J., Rose, U.S.R., Lewis, W.J., & Tumlinson, J.H. (1995) How caterpillar-damaged plants protect themselves by attracting parasitic wasps. *Proceedings of the National Academy of Sciences of the United States of America*, 92, 4169-4174.
- Van den Boom, C.E.M., Van Beek, T.A., Posthumus, M.A., De Groot, A., & Dicke, M. (2004) Qualitative and quantitative variation among volatile profiles induced by *Tetranychus urticae* feeding on plants from various families. *Journal of Chemical Ecology*, 30, 69-89.
- van Emden, H.F. (1986). The interaction of plant resistance and natural enemies: effects on populations of sucking insects. In *Interactions of plant resistance and parasitoids and predators of insects* (eds D.J. Boethel & R.D. Eikenbary), pp. 138-150. Ellis Horwood, Chichester, UK.
- Van Lenteren, J.C. & De Ponti, O.M.B. (1990) Plant-leaf morphology, host-plant resistance and biological control. *Symposia Biologica Hungarica*, 39, 365-386.
- Van Poecke, R.M.P. & Dicke, M. (2003) Indirect defence of plants against herbivores: Using *Arabidopsis thaliana* as a model plant. *Plant Biology* (submitted).
- Van Poecke, R.M.P., Posthumus, M.A., & Dicke, M. (2001) Herbivore-induced volatile production by *Arabidopsis thaliana* leads to attraction of the parasitoid *Cotesia*

- rubecula: Chemical, behavioral, and gene-expression analysis. *Journal of Chemical Ecology*, 27, 1911-1928.
- Vet, L.E.M. & Dicke, M. (1992) Ecology of infochemical use by natural enemies in a tritrophic context. *Annual Review of Entomology*, 37, 141-172.
- Wackers, F.L. (2004) Assessing the suitability of flowering herbs as parasitoid food sources: flower attractiveness and nectar accessibility. *Biological Control*, 29, 307-314.

Optimal methods of using marker information in gene introgression and gene pyramiding programs

Frédéric Hospital¹, Bertrand Servin^{1,2}, Olivier C. Martin³, Marc Mézard³

¹INRA, Station de Génétique Végétale, Ferme du Moulon, 91190 Gif-sur-Yvette, France.

Contact: fred@moulon.inra.fr, Tel +33.169.332.336

²University of Washington, Department of Statistics, Box 354322, Seattle, WA 98195-4322, U.S.A.

³Laboratoire de Physique Théorique et Modèles Statistiques, bâtiment 100, Université Paris-Sud, 91405 Orsay cedex, France

Abstract We review some recent work from our group on the theoretical optimisation of Marker-Assisted Selection programs in two cases: i) the use of markers to accelerate the introgression of one, or a few, target genes in a given genetic background through successive backcrosses and ii) the combination of a larger number of target genes (up to ten), without control of the genetic background, in gene pyramiding schemes involving successive pair-wise mating of individuals selected based on their genotypes at the target genes. Optimization applies to the number of generations and the number of crosses to perform, the number of individuals that should be genotyped for markers, and the choice of individuals to mate, in order to achieve the selection objective fast and at low cost.

Keywords: Marker-assisted selection, breeding strategies, gene introgression, backcross breeding, gene pyramiding.

Introduction

Once favourable genes of interest (herein called target genes) have been identified, for example after QTL detection, the next step in a breeding program is to combine those genes in a new, improved genetic material. Marker information can be used to accelerate this step, in so-called marker-assisted selection (MAS) programs (Dekkers and Hospital, 2002 ; Hospital 2003). Selection decisions in breeding programs can be based on phenotypic information alone (conventional selection), molecular information alone, or a combination of both. Here, we focus on breeding strategies involving selection based on molecular information alone. These are sometimes termed ‘Genotype Building’ (GB) strategies, because the selection phase can be reduced to a simple ‘building blocks’ problem. Prior to the start of the selection program, the breeder defines the ideal genotype (ideotype) at a collection of loci (target loci), as the one that meets the selection objective. The parents originally hosting the different target genes are crossed. Selection consists in screening, among the different genotypes produced by recombination in one or more generations, the ones that are closest to the ideotype, or that permit to obtain the ideotype most rapidly, simply based on DNA analysis (marker genotypes). Finally, at the end of the MAS program, phenotypic evaluation is performed in order to evaluate the agronomic value of the resulting progenies.

We review here some recent work from our group on the optimisation of such MAS programs in two cases of interest (among others). 1) The use of markers to accelerate the introgression of one, or a few, target genes in a given genetic background through successive backcrosses. 2) The combination of a larger number of target genes (up to ten), without control of the genetic background, in gene pyramiding schemes involving successive pair wise mating of individuals selected based on their genotypes at the target genes. In most cases, we assume that the target genes are well localized on the genome

and that they are well controlled either directly or through tightly linked markers. Optimization applies to the number of generations and the number of crosses to perform, the choice (number and chromosomal locations) of the markers to use, the number of individuals that should be genotyped for markers, and the choice of individuals to mate. The goal of optimization is to achieve the selection objective faster and/or at lower cost than conventional methods.

Optimisation of marker-assisted gene introgression in backcross breeding programs

Backcrossing is a widely used method for the improvement of varieties. The use of molecular markers to increase selection efficiency in marker assisted backcrossing (MAB) has been studied for some time. Typically, selection either on markers or on phenotypes is performed in three steps at each BC generation. Each of these steps has been a matter for theoretical optimizations. These are briefly reviewed here, with a focus on most recent advances and available computer programs.

Foreground selection

The first step is obviously to select for individuals that are heterozygous for the target gene(s) of interest. Markers can make this selection easier, and/or more efficient, and/or cheaper than phenotypic selection, depending on the biological material. Using markers to assess the presence of donor type alleles at known target genes has been studied by Melchinger (1990). This was later extended to the case when the target is a QTL (Hospital and Charcosset 1997). In this case, the choice of the markers must take into account the uncertainty in the target location. A computer program that implements the theoretical derivations of Hospital and Charcosset (1997) and helps the choosing of markers for QTL introgression is available upon request to fred@moulon.inra.fr.

Reduction of linkage drag

After a few backcross generations with selection for the target gene, most of the unwanted donor genes remain on the chromosome segment surrounding the target (linkage drag). An impressive experimental proof of this was provided by Young and Tanksley (1989a). Reducing linkage drag is then a key issue in backcross breeding, and here selection on markers can be of great help.

Basically, linkage drag can be reduced by performing selection at two markers flanking the target, one on each side. Here, the objective is to select individuals that are heterozygous at the target locus, and homozygous for the recipient allele at both flanking markers. Obviously, one would like to select for flanking markers that are as close as possible to the target. However, recombination is less frequent with closer markers. This implies genotyping and screening larger populations which increases the cost of the breeding program.

To minimize genotyping effort (*i.e.*, the cost of the program) one should perform two, three or more backcrosses, and determine the minimal population sizes necessary at each generation (Hospital 2001). A computer program (*popmin*) that performs these calculations (Hospital and Decoux, 2002) is freely available at <http://moulon.inra.fr/~fred/programs>.

Background selection

The last selection step is aimed at accelerating the return to a fully recipient genotype on non-carrier chromosomes (chromosomes that do not carry the target gene of interest). Since the benchmark papers of Tanksley (1983) and Tanksley *et al.* (1989), numerous

papers have addressed the use of markers in this case (e.g., Hillel *et al.*, 1990; Hospital *et al.*, 1992; Groen and Smith, 1995; Visscher *et al.*, 1996; Ribaut *et al.* 2002).

Here, the objective is to select individuals that are of homozygous recipient type at a collection of markers located on non-carrier chromosomes. Again, several markers are involved and it is unlikely that the selection objective is fulfilled in a single generation (BC_1), so that selection on markers should be performed over two or more BC generations. Obviously, selection on markers is most efficient if the markers are optimally positioned along the chromosomes. Such optimal positions were derived by Servin and Hospital (2002). However, a precise positioning of the markers on non-carrier chromosomes is not mandatory, in contrast to the case of the reduction of linkage drag (see above).

Note that one can use molecular markers to estimate the Recipient Genome Contents (RGC) of backcross progenies. This necessitates computation of the probabilities of allelic transmission through complex pedigrees. We designed the computer program *Grafgen* (Servin and Hospital 2004a) for doing so. The program produces *precision graphical genotypes* (Figure 1) which extend the concept of graphical genotypes introduced by Young and Tanksley (1989b) to ‘portray the parental origin and allelic composition throughout the genome’.

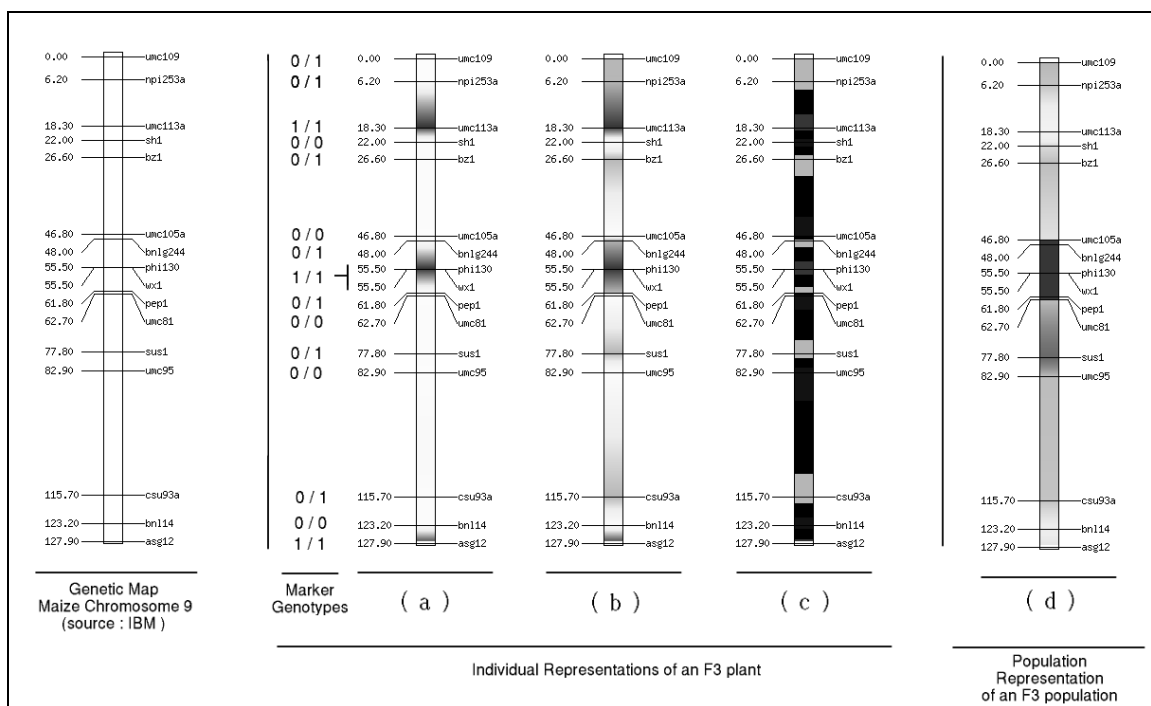

Figure 1. Possible representations of Precision Graphical Genotypes with the Grafgen program. Example of an F3 population with two alleles segregating (noted 0 and 1). Grafgen represents for each individual either : (a) the probability of being of a given genotype (here the homozygote 1/1), or (b) the expected number of copies of a particular allele (here allele '1'), or (c) the zones where the probabilities of given genotypes exceed a given threshold (here, the zones of probability > 0.8 are green for the heterozygote 0/1, red for the homozygote 1/1, and blue for homozygote 0/0); Grafgen can also represent a synthetic "genotype" for the whole population, according to the mean allele frequency in the population (d). From Servin and Hospital (2004a). Colours have been converted to greyscale for reproduction).

Overall optimization in case-studies

Our current work is aimed at combining all previous theoretical results on the optimization of each selection step, to provide optimal BC breeding strategies in practical cases. Two examples are given in Table 1. The linkage drag of 10 cM corresponds to the case of introgression between elite material; the linkage drag of 2 cM corresponds to introgression from a wild genetic resource.

Table 1. Examples of optimal BC breeding strategies in case studies: simulation results. The genetic map is assumed to be 10 chromosomes, each of 200 cM long. The number of markers given is $2+9x$, meaning that there are two markers around the target on the carrier chromosome, plus x on each of the nine other chromosomes. (Servin 2003; Servin and Hospital 2004b)

Linkage drag (cM)	Number of markers	Number of BC generations	Recipient Genome Content (%)	Population Size per BC generation	Marker Data Points (total)
10	20	3	97.0	100	820
		4	98.3	40	410
	29	3	97.8	150	1535
		4	98.7	40	504
2	20	5	99.2	130	1374
		5	99.4	130	1591
	38	4	99.2	170	2054
		5	99.5	130	1912
	47	4	99.3	170	2330
		5	99.6	130	2195

Optimisation of marker-assisted gene pyramiding schemes

The backcross breeding strategies described above are useful for the introgression of a target gene in a particular genetic background, when preservation of the genetic background is important. In general, this is used for introgression from wild genetic resources into elite material. However, the number of target genes that can be manipulated simultaneously in backcross programs is severely limited: usually no more than four with acceptable population sizes (Hospital and Charcosset 1997).

With the advances of molecular breeding, it might be necessary to manipulate larger number of genes. If control of the genetic background is not mandatory, for example when several genes of interest have been identified in different varieties that are already of good agronomic value, and if the objective is to combine those genes in a same variety, then gene pyramiding may be a good strategy.

Recently, we investigated the optimization of gene pyramiding schemes (Servin et al. 2004). Assuming individuals can be selected and mated according to their genotype, the best procedure corresponds to an optimal succession of crosses over several generations (pedigree). Assuming that a collection of parents P_i is available, such that each P_i is homozygous for a given target gene G_i , there are several ways to cross those parents to get finally the ideal genotype I combining all target genes. Examples of different possible gene pyramiding schemes in the case of five parents and five target genes are given in Figure 2.

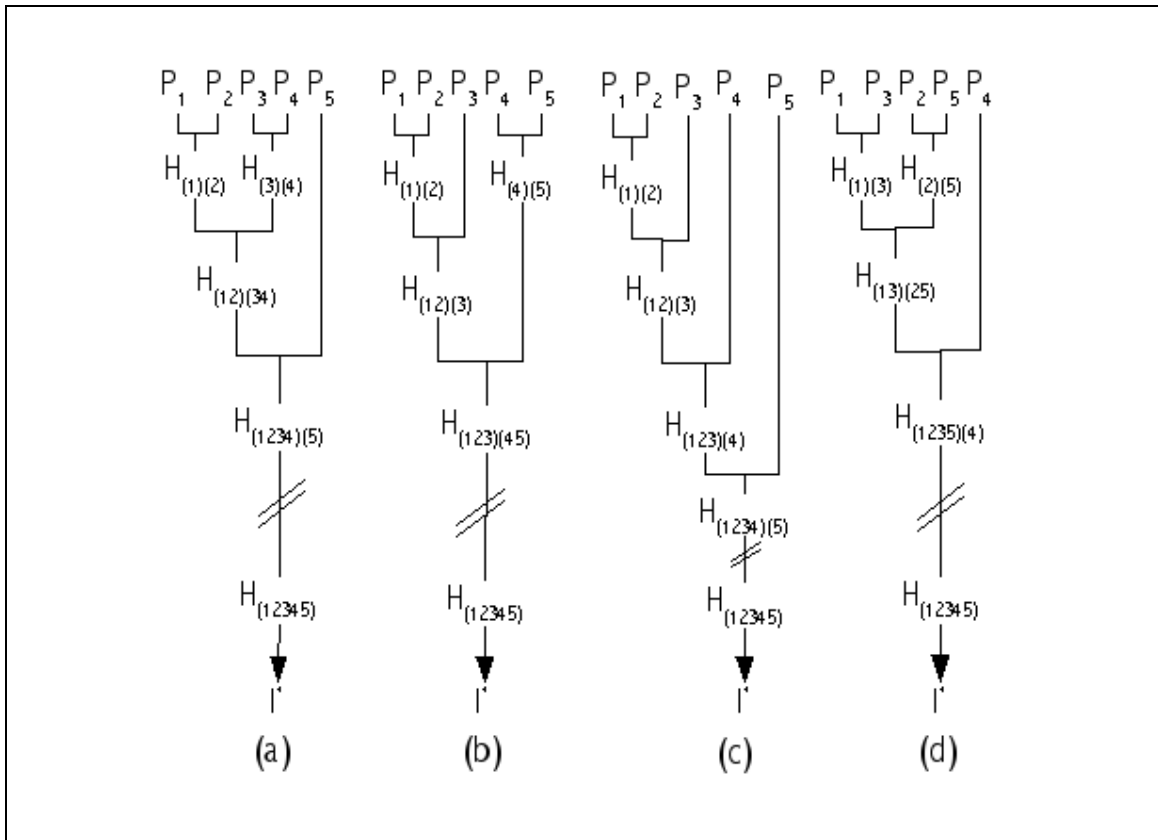

Figure 2. Examples of different gene pyramiding schemes in the case of five parents and five target genes.

We provided an algorithm that generates all possible pedigrees. For each pedigree, we compute the probability to obtain the desired genotype from the known recombination fractions between the target loci. Then we deduce the number of individuals (population sizes) that should be genotyped over successive generations until the desired genotype is obtained.

One can then compare pedigrees based on the population sizes they require and on their total duration (in number of generations) to find the best gene pyramiding scheme. As an example of the results, Table 2 gives the population sizes required by optimal gene pyramiding schemes for eight target genes. These are compared to a reference genotype selection method with random mating (MBRS, Hospital et al. 2000).

It is seen that the best gene pyramiding methods are more efficient than the reference method. Optimal gene pyramiding methods can combine the eight targets in three generations less, or with far fewer genotyped individuals than the reference method.

Table 2. Efficiency of optimal gene pyramiding schemes to combine eight targets, compared to a reference method. Target genes are located on a same chromosome, with a recombination fraction corresponding to 20 cM between the target genes. In single-step crossings, two individuals are crossed and their progeny is screened for the desired genotype. In two-steps crossings, the two individuals are first hybridized with a known line, then the hybrids are crossed and their progeny is screened for the desired genotype. Total population sizes correspond to the sum of populations sizes at all generations of the scheme. Max is the size of the largest population needed amongst the different generations. From Servin et al. (2004).

Number of generations	Population sizes					
	Single-step crossings		Two-steps crossings		MBRS	
	Total	Max	Total	Max	Total	Max
5	4415	1248	-	-	-	-
6	2741	1248	-	-	-	-
7	2421	870	1147	341	7560	1080
8	2183	606	1166	341	3440	430
9	1394	341	1273	341	1710	190
10	-	-	-	-	1100	110
11	-	-	-	-	880	80
12	-	-	-	-	840	70

Acknowledgements

During his PhD thesis at the Station de Génétique Végétale Bertrand Servin was jointly supported by the Institut National de la Recherche Agronomique (INRA) and Euralis Genetics grant BTH00956.

References

- Dekkers, J.C.M. & Hospital, F. 2002: The use of molecular genetics in the improvement of agricultural populations. *Nature Reviews Genetics*, 3, 22-32.
- Groen, A.F. & Smith, C. 1995 : A stochastic simulation study on the efficiency of marker-assisted introgression in livestock. *Journal of Animal Breeding and Genetics*, 112, 161-170.
- Hillel, J. Schaap, T. Haberfeld, A. Jeffreys, A. J. Plotzky, Y. Cahaner, A. & Lavi, U. 1990: DNA fingerprint applied to gene introgression breeding programs. *Genetics*, 124, 783-789
- Hospital, F. 2001: Size of donor chromosome segments around introgressed loci and reduction of linkage drag in marker-assisted backcross programs. *Genetics*, 158, 1363-1379.
- Hospital, F. 2003: Marker-assisted breeding. In H.J. Newbury (ed.) *Plant Molecular Breeding*. Blackwell Scientific Publishers, London, UK, pp30-56.
- Hospital, F., Chevalet, C. & Mulsant, P. 1992: Using markers in gene introgression breeding programs. *Genetics*, 132, 1199-1210.
- Hospital, F. & Charcosset, A. 1997: Marker-assisted introgression of quantitative trait loci. *Genetics*, 147, 1469-1485.

- Hospital, F., Goldringer, I. & Openshaw, S. 2000: Efficient marker-based recurrent selection for multiple quantitative trait loci. *Genetical Research*, 75, 357–368.
- Hospital, F. & Decoux, G. 2002: Popmin: a program for the numerical optimization of population sizes in marker-assisted backcross programs. *J. Hered.*, 93: 383-384.
- Melchinger, A.E. 1990: Use of molecular markers in breeding for oligogenic disease resistance. *Plant Breeding*, 104, 1-19.
- Ribaut, J.-M. Jiang, C. & Hoisington, D. 2002: Simulation Experiments on Efficiencies of Gene Introgression by Backcrossing. *Crop Science*, 42, 557-565.
- Servin, B. 2003: Methodes de construction de genotypes assistee par marqueurs. PhD Thesis, Universite Paris XI, Orsay, France.
- Servin, B. & Hospital, F. 2002: Optimal positioning of markers to control genetic background in marker assisted backcrossing. *J. Hered.* 93: 214-217.
- Servin B., Martin O. C., Mezard M., & Hospital F. 2004: Towards a theory of marker assisted gene pyramiding. *Genetics* (Accepted pending revisions).
- Servin, B & Hospital, F. 2004a: GRAFGEN : A program to design precision graphical genotypes. In revision.
- Servin, B. & Hospital, F. 2004b: Optimal strategies of gene introgression in marker-assisted backcross breeding: two case-studies. In prep.
- Tanksley, S. D. 1983: Molecular markers in plant breeding. *Plant Molecular Biology Reporter*, 1, 3-8.
- Tanksley, S.D. Young ND, Paterson AH & Bonierbale MW 1989: RFLP mapping in plant breeding: new tools for an old science, *Biotechnology*, 7, 257-264
- Visscher, P.M., Haley, C.S. & Thompson, R. 1996: Marker-assisted introgression in backcross breeding programs. *Genetics*, 144, 1923-1932.
- Young, N.D. & Tanksley, S.D. 1989a: RFLP analysis of the size of chromosomal segments retained around the tm-2 locus of tomato during backcross breeding. *Theoretical and Applied Genetics*, 77, 353-359.
- Young, N.D. & Tanksley, S.D. 1989b: Restriction fragment length polymorphism maps and the concept of graphical genotypes. *Theoretical and Applied Genetics*, 77, 95-101.

GENETIC RESOURCES

The taxonomic answer to the species dilemma in *Capsicum chinense* and *C. frutescens*: a key issue for *Capsicum* improvement and conservation genetics.

Paul W. Bosland, Jit B. Baral

Department of Agronomy and Horticulture, P.O. Box 30003, MSC 3Q, New Mexico State University, Las Cruces, New Mexico, U.S.A., 88003. Contact: pbosland@nmsu.edu, Tel +505.646.5171

Abstract: One of the most lingering questions in *Capsicum* taxonomy is whether *C. chinense* Jacq. and *C. frutescens* L. are two different species or botanical varieties of one another. The relationship between the two appeared to be so close that separate species treatment is questioned by some researchers. Therefore, to test whether or not these are truly distinct species, a comprehensive examination of *C. frutescens* and *C. chinense* was undertaken. Morphological characters were examined to determine whether fixed differences exist between *C. frutescens* and *C. chinense* (**typological species**). Randomly amplified polymorphic DNA (RAPD) marker-based cluster analysis tested whether or not they would separate as two species (**phylogenetic species**). The sexual compatibility between *C. frutescens* and *C. chinense* was investigated to understand whether *C. frutescens* and *C. chinense* are reproductively isolated (**biological species**). All three approaches provided evidence that *C. frutescens* and *C. chinense* are distinct species. Thus, using any one of the three definitions of a species, *C. frutescens* and *C. chinense* were validated as separate species. Furthermore, the RAPDs have explanatory power and could be used to identify the species. Two particularly important features of RAPDs were its ability to distinguish the species before the plant flowers, and its ability to detect interspecific introgression. Numerous interspecific introgression events have occurred between these two species, and these interspecific introgression accessions have been the cause for the difficulty in identifying the two species in the past. This information will be useful in conservation genetics and crop improvement.

Keywords: *Capsicum chinense*, *Capsicum frutescens*, chile pepper, species, interspecific introgression, typological species, phylogenetic species, biological species

Introduction

For about 50 years, it has been debated whether *Capsicum chinense* and *C. frutescens* are two different species (Smith and Heiser, 1957), or conversely one species, but botanical varieties of one another (Eshbaugh et al., 1983). *Capsicum frutescens* has maintained its species recognition since Linnaeus (1753). He described it as having paired pedicels per node and a frutescent stem, i.e. perennial plant habit. Shaw and Khan (1928) added waxy greenish-white corolla as a unique character of *C. frutescens*. In addition, Standley (1931) stated that *C. frutescens* has small fruits and the pedicel is generally longer than the fruit.

The name *C. sinense* (*C. chinense*) was first given by Jacquin in 1776. But this recognition was unknown until Smith and Heiser (1957) re-examined plant materials and suggested separating Jacquin's *Capsicum sinense* from *C. frutescens* and renaming it as *C. chinense*. Smith and Heiser (1957) described *C. chinense* as having glabrous leaves and stem, with ovate to ovate lanceolate leaves. There are two to five flower buds per node, and pedicels are declinate and relatively short and thick. In addition, it has a calyx without teeth, but with a marked constriction between the pedicel and calyx.

However, there are accessions that possess one or a few diagnostic morphological characters from one species and the rest of the characters from the other species, which has created difficulties in species assignment. As more accessions of both species were

studied, they were found to be closely related. The relationship appeared to be so close that separate species treatment was eventually questioned by several researchers (Eshbaugh 1993; McLeod et al. 1983; Pickersgill 1988). The conflicting reports have confounded the biological and taxonomic relationships between these two species.

Capsicum frutescens and *C. chinense* are sympatrically distributed throughout their range in Peru, Brazil, Colombia, and Bolivia. A numerical taxonomic analysis using morphological characters could not separate the accessions of *C. frutescens* and *C. chinense* according to species (Pickersgill et al. 1979). Similarly, use of various enzyme loci also could not distinguish *C. annuum*, *C. frutescens*, and *C. chinense* accessions (Jensen et al., 1979). Egawa and Tanaka (1984) reported fertile interspecific hybrids between *C. frutescens* and *C. chinense* with regular meiosis.

The concept of a species can be defined several ways. Three of the most common species concepts are typological, phylogenetic, and biological. The typological, phylogenetic, and biological species correspond to the morphological, phylogenetic, and sexual compatibility approaches, respectively. Morphological characters were examined to determine whether fixed differences exist between *C. frutescens* and *C. chinense* (typological species concept). Randomly amplified polymorphic DNA (RAPD) marker-based cluster analysis determined if *C. frutescens* and *C. chinense* are two separate species, based on the phylogenetic species concept. The sexual compatibility between *C. frutescens* and *C. chinense* was investigated to understand whether *C. frutescens* and *C. chinense* are reproductively isolated (biological species concept).

Material and methods

Plant material

A total of 211 accessions of *C. frutescens* and 223 accessions of *C. chinense* were acquired from the USDA, Regional Plant Introduction Station, Griffin, GA, U.S.A. and the New Mexico Capsicum Accession (NMCA) collection at New Mexico State University, Las Cruces, NM, U.S.A. The accessions were chosen to represent a global collection.

Morphology Study

Morphological data were collected from plants in field plots for leaf texture, number of flowers per axil, flower position, calyx margin, calyx constriction, corolla color, anther color, filament color, fruit persistence, and fruit size. To determine if any combination of morphological characteristics could separate these two species, the data were analyzed by discriminate function analysis (SAS Institute 2001).

RAPD Analysis

Accessions were selected for RAPD analysis based on morphological characterizations. Plants fitting the taxonomic description of *C. frutescens* and *C. chinense* and showing uniformity in the field were selected for RAPD analysis. From the original 434 accessions, 41 accessions of *C. frutescens* and 34 accessions of *C. chinense* were chosen. In addition, 'Greenleaf Tabasco', a known interspecific hybrid between *C. frutescens* and *C. chinense* was also included. 'Greenleaf Tabasco' possesses most of the characters of *C. frutescens*, but has some features, such as a constricted calyx and virus resistance from *C. chinense* (Greenleaf et al. 1970). One accession of *C. annuum* was used as an outlier. RAPD analysis followed the protocol of Votava and Bosland (2002). Primers used were: OPAA-11, OPE-05, OPM-04, OPA-04, OPA-07, OPE-12, OPC-06, OPA-16, OPE-02, OPA-17, OPF-05, OPM-09, and OPA-02.

Distribution of RAPD frequency among the accessions of each species was plotted on a graph. The unweighted pair-group with arithmetic averages (UPGMA) method was

used in the cluster analysis (Sneath and Sokal 1973). The similarity coefficient for all possible pairwise combinations was calculated using an algorithm to calculate the Dice similarity coefficient for all possible pairwise combinations (Dice 1945). The value of similarity coefficient lies between “0” and “1.” The pairwise similarity coefficient matrix was used for the cluster analysis using UPGMA method. The result of the cluster analysis was represented in the form of a dendrogram (Figure 1).

Sexual Compatibility

For the sexual compatibility study, five *C. chinense* and five *C. frutescens* accessions were selected based on the results of the RAPD analysis to maximize the genetic distance among the hybridizing parents. All possible combinations including reciprocal hybridizations were made. The hybridizations were accomplished in a climate-controlled greenhouse. Initially five hybridizations per combination were attempted, but if the flower aborted after pollination, the hybridization was repeated. Up to 15 hybridizations were made for some combinations. The mature fruits were harvested and the number of seeds set in each fruit was recorded.

Analysis of F₁ progeny

Seeds of the F₁ progeny were germinated in the laboratory. The seedlings were transplanted into pots in a greenhouse. Three F₁ plants from each hybrid combination were selected for pollen viability testing. Three flowers prior to anthesis were collected from each plant. The anthers were placed on a microscope slide with a drop of 0.75% aceto-carmin. The anthers were ruptured with forceps to release the pollen grains. The total number of pollen grains and the number of viable pollen grains were counted. Three counts were taken per slide.

Results and discussion

Morphology Study

With the morphological characterization the accessions were assigned to the corresponding species. According to the morphological characteristics, 70% of the accessions agreed with the species assignment. Among the accessions assigned to *C. frutescens*, 8% belonged to *C. chinense*. Similarly, among the *C. chinense* accessions, 9% belonged to *C. frutescens*.

Phenotypic variation was observed for fruit shape, size, and color. There were some accessions in *C. frutescens* that had large, persistent (non-deciduous) fruits. These accessions were originally collected in Costa Rica and Guatemala.

Discriminant function analysis found that calyx constriction and flower position were the most useful combination of morphological characters to differentiate the two species. When these two characteristics were used in the analysis, 95% of the *C. frutescens* accessions could be correctly identified, and similarly, 94% of the *C. chinense* accessions could be correctly identified.

RAPD Analysis

The genetic similarities within a species and between the species were calculated by averaging the Dice's similarity coefficient for pairwise comparison. The average genetic similarity between *C. frutescens* and *C. chinense* was 0.38, whereas the average genetic similarity within *C. frutescens* was 0.85 and within *C. chinense* was 0.86. The dendrogram had two distinctive clusters, one containing all the *C. frutescens* accessions, and another containing all the *C. chinense* accessions. The cluster analysis placed 'Greenleaf Tabasco' in the *C. frutescens* group indicating high genetic similarity, but was

distinctly separated from rest of the *C. frutescens* accessions occupying an intermediate position between the *C. frutescens* and the *C. chinense* group. (Fig. 1)

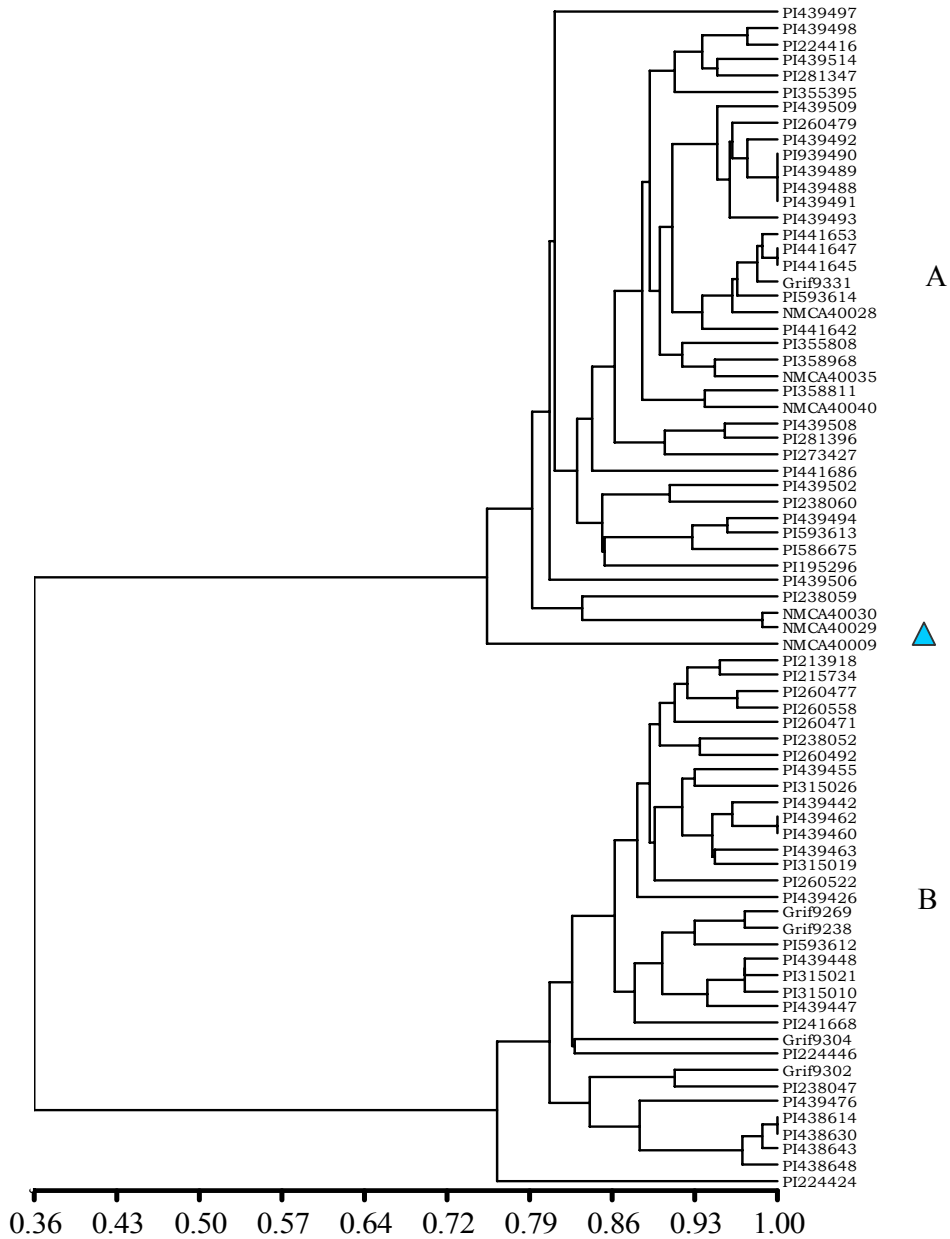

Figure 1. Dendrogram showing genetic relationship among the accessions of *Capsicum frutescens* and *C. chinense* as revealed by RAPD markers. A = *C. frutescens*, B = *C. chinense*, ▲ = Greenleaf Tabasco.

Sexual Compatibility.

With sexual compatibility, five accessions of *C. frutescens* (PI 439497, PI 439498, PI 939489, PI 441642, and PI 195296) and five accessions of *C. chinense* (PI 213918, Griff 9269, Griff 9302, PI 438648, and PI 315026) were hybridized. A total of 829 hybridizations were performed, 369 of which were between species, and 460 of which were within species. From the 93 hybridization combinations, 87 combinations developed fruits with seeds, and six combinations developed fruits without seeds. The paired t-test of reciprocal hybridization was not significant ($p = 0.80$), indicating the absence of unidirectional incompatibility between these two species. Selfing in *C. frutescens* gave

only a 15% fruit set, whereas the hybridization among the accessions (sibbing) of *C. frutescens* produced a 36% fruit set. The difference between selfing and sibbing is an indication of a weak self-incompatibility system in *C. frutescens*.

The pollen viability of the F₁ plants derived from the interspecific hybridizations was very low as compared to the intraspecific F₁ plants. Pollen grains of *C. frutescens* and *C. chinense* were similar in shape, size, and appearance under the microscope. The acetocarmine staining technique successfully discriminated normal, viable pollen from non-viable pollen. Pollen viability was 28% in interspecific hybrid plants, and 75% in intraspecific hybrids.

In conclusion, *Capsicum frutescens* and *C. chinense* can be identified in most situations by the combination of two diagnostic morphological characters: calyx constriction and flower position. The presence of species-specific RAPD markers also provided evidence that fixed differences exist between the two species at the molecular level. *Capsicum frutescens* and *C. chinense* represent two diagnosable clusters based on shared genetic markers. The result of the cluster analysis represented in the form of a dendrogram has clearly separated each species into separate clusters.

The RAPD analysis also gave evidence that *C. frutescens* is not the primitive form and ancestor of *C. chinense* (Eshbaugh et al. 1983). If *C. chinense* was derived from *C. frutescens*, *C. chinense* accessions would form a cluster nested within *C. frutescens*. However, the data clearly showed parallel genetic diversity in *C. chinense* accessions, which was independent of *C. frutescens*.

Capsicum accessions with intermediate phenotypes, is best explained by introgressive hybridization between *C. chinense* and *C. frutescens*. The cultivar Greenleaf Tabasco offered an excellent example of this type of introgression. The development of partial sterility in the interspecific hybrid progenies provides evidence for reproductive isolation. Thus, there appears to be a genetically controlled mechanism(s) that is preventing gene flow between *C. frutescens* and *C. chinense*.

Morphological observations, RAPD based cluster analysis, and sexual compatibility provide evidence that *C. frutescens* and *C. chinense* are distinct species. Whether the species concept used is typological, phylogenetic, or biological, they all unanimously support the proposition that these two groups of plants are separate species. Furthermore, the RAPDs have explanatory power and can be used as a basis for establishing species identification. Two particularly important features of RAPDs were ability to do the analysis before the plant flowers, and the ability to detect interspecific introgression. The method clearly demarcates those accessions having risen from interspecific introgression, and may be useful in conservation genetics and crop evolution.

Acknowledgements

A contribution of New Mexico State University, Agriculture Experiment Station, Las Cruces, New Mexico, U.S.A.

References

- Dice, L.R. 1945: Measures of the amount of ecological association between species. *Ecology* 26: 297-302.
- Egawa, Y. and Tanaka, M. 1984: Cytogenetic relationships among three species of chilipeppers, *Capsicum chinense*, *Capsicum frutescens*, and *Capsicum baccatum*. *Japanese Journal of Breeding* 34: 50-56.
- Eshbaugh, W.H. 1993: Peppers: history and exploitation of a serendipitous new crop

- discovery. Pp. 132-139 in *New Crops*, Ed. J. Janick and J.E. Simon. Wiley and Sons, New York.
- Eshbaugh, W.H., Guttman, S.I. and McLeod, M.J. 1983: The origin and evolution of domesticated *Capsicum* species. *Journal of Ethnobiology*. 3: 49-54.
- Greenleaf, W.H., Martin, J.A., Lease, J.G., Sims, E.T. and Van Blaricom, L.O. 1970: Greenleaf Tabasco, A new tobacco etch virus resistant 'Tabasco' pepper variety (*Capsicum frutescens* L.). Alabama Agricultural Experiment Station, Auburn University, AL, U.S.A. Leaflet. No. 81. 10p.
- Jacquin, N.J. 1776: *Hortus Botanicus Vindobonensis* 3 pl. 82.
- Jensen, R.J., McLeod, M.J., Eshbaugh, W.H., and Guttman, S.I. 1979: Numerical taxonomic analyses of allozymic variation in *Capsicum* (Solanaceae). *Taxon* 28: 315-327.
- Linnaeus, C. 1753: *Species plantarum*. Laurentii, Salvi, Stockholm.
- McLeod, M.J., Guttman, S.I., Eshbaugh, W.H., and Rayle, R.E. 1983: An electrophoretic study of the evolution in *Capsicum* (Solanaceae). *Evolution* 37: 562-574.
- Pickersgill, B. 1988: The genus *Capsicum*: a multidisciplinary approach to the taxonomy of cultivated and wild plants. *Biologische Zentrablatt* 107: 381-389.
- Pickersgill, B., Heiser Jr., C. B. and McNeill, J. 1979: Numerical taxonomic studies on variation and domestication in some species of *Capsicum*. Pp. 679-700, in *The biology and taxonomy of the Solanaceae*, Eds. Hawkes, J. G., R. N. Lester, A. D. Skelding. Academic Press, London.
- SAS Institute Inc. 2001: SAS Software release 8.2. SAS Inst. Inc. Cary, NC.
- Shaw, F. J. F. and KHAN, A.R. 1928: *Studies in Indian chillies*. Department of Agriculture, India, *Memories Botanical Series* 16: 59-82.
- Smith, P.G. and Heiser Jr., C.B. 1957: Breeding behavior of cultivated peppers. *Proceedings of the American Society for Horticultural Science* 70: 286-290.
- Sneath, P.H.A. and Sokal, R.R. 1973: *Numerical taxonomy*, W. H. Freeman and Co., San Francisco, CA.
- Standley, P.C. 1931: *Flora of the Lancetilla Valley, Honduras*. Field Museum of Natural History Botanical Series 10.
- Votava, E. J. and Bosland, P.W. 2002: A cultivar by any other name: genetic variability in an heirloom bell pepper- *Capsicum annuum* L. var. *annuum* 'California Wonder'. *HortScience* 37:1100-1102.

Spanish traditional varieties of eggplant: diversity and interest for plant breeding

J. Prohens, J. M. Blanca, A. Rodríguez-Burruezo, F. Nuez

Centro de Conservación y Mejora de la Agrodiversidad Valenciana, Universidad Politécnica de Valencia, Camino de Vera 14, 46022 Valencia, Spain. Contact: fnuez@btc.upv.es, Tel +34.963877421

Abstract: Eggplant (*Solanum melongena*) was introduced into Spain by the Arabs. Since then, many local varieties have appeared. These materials represent an important source of variation for breeding programmes. We have studied the morphological and molecular (AFLP) diversity of a collection of 27 accessions of Spanish accessions of eggplant that were grown both in the open field (summer crop) and in greenhouse (winter crop). Other accessions from different origins (European, Asian and South American) were used as controls. Yield and morphological diversity were studied in both growing environments. Yield was very variable among accessions and there were varieties showing a stable behaviour while others were specifically adapted to either open field or greenhouse cultivation. High yield of some accessions either in the open field or in greenhouse indicates that some local varieties have great potential for eggplant breeding. Results of the morphological characterization show that Spanish accessions display an important variation for most of the traits studied. Most morphological traits were not greatly affected by the growing environment (open field or greenhouse). However, for others such as those related to the pigmentation of plant and flowers, prickliness and fruit shape, there were differences among environments. The study of the molecular (AFLP) diversity shows that control accessions are not genetically differentiated from the Spanish accessions, indicating that the Spanish eggplants encompass an important part of the genetic diversity present in this crop. Comparisons of the level of diversity with other Solanaceous crops studied with the same technique in our laboratory shows that eggplant is similar in molecular diversity to tomato (*Lycopersicon esculentum*), but less diverse than pepino (*Solanum muricatum*). Implications of the differences in yield and of the morphological and molecular diversity on eggplant breeding are discussed.

Keywords: *Solanum melongena*, yield, stability, genotype x environment interaction, characterization, AFLPs, genetic diversity.

Introduction

Evidence indicates that Arabs introduced eggplant (*Solanum melongena* L.) into Spain (Nuez et al. 2002). Since then, a considerable diversity of Spanish eggplants has been accumulated and many different traditional varieties have arisen (Prohens and Nuez 2001). The evolution of these local varieties has been linked to open field cultivation. However, nowadays the economic importance of greenhouse cultivation is much greater than cultivation in the open field, and most of the varieties used in Spain, especially F₁ hybrids, are specifically developed for greenhouse cultivation (Anonymous 1997; Marín 2000). Usually, F₁ hybrids are heterotic for yield (Choudhury 1995), and because they do not breed true they are of interest for seed companies. Hybrids have a low morphological diversity and most types have a uniform purple or purple black colour (Daunay et al. 1997; Marín 2000). However, as has occurred in tomato (Nuez 1995) and pepper (Nuez et al. 1997) there is an interest in the markets for a diversification of eggplant types.

Main breeding objectives for eggplant in Europe are yield, fruit quality, agroclimatic adaptation and resistance to pests and diseases (Daunay et al. 1997). Spanish traditional varieties may be useful for obtaining hybrids or other types of commercial varieties, either for open field or greenhouse cultivation, for diversification of types, and also for the widening of the genetic base of the modern varieties. Morphological and molecular characterization of collections is of interest because it can lead to the discovery of

materials of value, establish relationships among varieties and provide estimates of the genetic diversity. Here we compare the yield and morphological characteristics of a collection of Spanish eggplants grown both in the open field and in the greenhouse. We also study its molecular diversity with amplified fragment length polymorphisms (AFLPs).

Material and methods

Plant material and growing conditions

Twenty-seven accessions of Spanish traditional eggplants comprising different morphological types and regions of origin were used for the present experiment (Table 1). Four accessions of different origins (a Chinese and a Cuban traditional varieties, a French breeding line, and a Spanish commercial selection) were used as controls. All materials corresponded to *S. melongena* group H (Lester and Hasan 1991). Each accession was grown in two environments: open field (summer crop; five plants per accession) and greenhouse (winter crop; seven plants per accession) at the facilities of COMAV (Valencia, Spain). Plants were arranged in a completely randomized design and spaced 1 x 0.5 m (open field) or 1 x 0.3 m (greenhouse). They were trained with bamboo canes and drip irrigated.

Characterization

Yield per plant was measured and expressed as $\text{kg}\cdot\text{m}^{-2}$. Plants were characterized for 35 morphological traits using the primary descriptors developed by the European Eggplant Genetic Resources Network (EGGNET). DNA extractions and AFLP reactions were performed as described elsewhere (Nuez et al. 2004). The following combinations of primers were used: Mse CAA-Eco AGC Hex, Mse CAA-Eco ACT FAM, Mse CTA-Eco ACT FAM, Mse CTA-Eco ACG NED.

Data analyses

Yield data were subjected to analysis of variance as described in Rodríguez-Burruezo et al. (2002). Accession x growing environment interactions were studied by means of regression analysis (Dabholkar 1992). Varieties with regression coefficients (β) do not differ significantly from 0 are considered to have “static stability” (no change across environments), while those in which β does not differ from 1 are considered as having “dynamic stability” (change paralleling the means of environments) (Kang 1998). Signification of differences among environments for morphological data were studied with a paired Student’s *t* test. Genetic similarity data were calculated using the Dice similarity coefficient and used to generate an UPGMA phenogram.

Results and discussion

Yield

Important differences were found among traditional varieties in yield, especially under greenhouse conditions (Table 1). Some traditional varieties gave good yields, greater than any of the controls used, confirming that these materials may provide good sources of variation for eggplant yield breeding. Although local varieties already existed before the widespread cultivation of eggplants in greenhouse, yield was as a mean greater in the greenhouse than in the open field. However, there was an important genotype x environment interaction (Table 2). In this sense, some varieties showed static stability (β not significantly different from 0) and no differences of yield were found among environments, although most of these varieties (except MUS4 and VS10) had relatively

low yields. Kang (1998) indicated that varieties with $\beta=0$ generally are well adapted to poor environments. Also, varieties were found having “dynamic stability” (β not significantly different from 1).

Table 1. Region or country of origin of accessions studied, yield, regression coefficient (β) of yield over the environmental mean and value of F statistic for testing β deviation from 0 (F_0) or 1 (F_1) for eggplant accessions evaluated in the open field and in greenhouse in Valencia, Spain.

Accession	Origin	Yield ($\text{kg}\cdot\text{m}^{-2}$)		β	F_0	F_1
		Open field	Greenhouse			
<i>Spanish traditional varieties</i>						
ANS3	Andalusia	1.66	6.52	3.41	19.854 ^{***}	9.919 ^{**}
ANS6	Andalusia	5.63	8.40	1.94	6.450 [*]	1.521 ^{ns}
ANS24	Andalusia	1.20	1.52	0.23	0.086 ^{ns}	1.026 ^{ns}
ANS26	Andalusia	3.84	1.71	-1.50	3.814 ^{ns}	10.622 ^{**}
ANS37	Andalusia	1.28	3.08	1.26	2.723 ^{ns}	0.118 ^{ns}
BS3	Balearic Islands	2.10	0.67	-1.00	1.719 ^{ns}	6.851 ^{**}
CS5	Catalonia	1.43	4.02	1.82	5.639 [*]	1.141 ^{ns}
CS16	Catalonia	2.72	2.19	-0.37	0.236 ^{ns}	3.212 ^{ns}
CS21	Catalonia	1.66	4.33	1.87	5.992 [*]	1.303 ^{ns}
CMS2	Castilla-La Mancha	1.70	2.00	0.21	0.076 ^{ns}	1.064 ^{ns}
IVIA25	Valencia	4.20	1.60	-1.83	5.682 [*]	13.617 ^{***}
IVIA178	Valencia	2.44	1.08	-0.95	1.555 ^{ns}	6.519 [*]
IVIA371	Valencia	3.53	0.00	-2.48	10.474 ^{**}	20.636 ^{***}
IVIA400	Valencia	3.27	1.38	-1.33	3.003 ^{ns}	9.236 ^{**}
IVIA604	Valencia	4.80	1.05	-2.63	11.821 ^{***}	22.510 ^{***}
MUS3	Murcia	3.19	2.62	-0.40	0.273 ^{ns}	3.345 ^{ns}
MUS4	Murcia	5.18	6.76	1.11	2.098 ^{ns}	0.020 ^{ns}
MUS5	Murcia	3.38	7.90	3.17	17.173 ^{***}	8.053 [*]
MUS6	Murcia	2.94	17.93	10.52	188.877 ^{***}	154.677 ^{***}
MUS7	Murcia	0.92	4.91	2.80	13.382 ^{***}	5.531 [*]
MUS8	Murcia	2.90	6.64	-0.64	11.758 ^{***}	4.505 [*]
VS2	Valencia	1.87	3.10	0.86	1.272 ^{ns}	0.032 ^{ns}
VS8	Valencia	3.28	4.60	0.93	1.465 ^{ns}	0.009 ^{ns}
VS9	Valencia	3.30	9.52	4.37	35.520 ^{***}	19.328 ^{***}
VS10	Valencia	6.29	7.05	0.53	0.486 ^{ns}	0.372 ^{ns}
VS19	Valencia	2.33	0.33	-1.40	3.362 ^{ns}	9.860 ^{**}
VS21	Valencia	2.90	1.52	-0.97	1.601 ^{ns}	6.613 [*]
Mean		2.96	4.16			
<i>Controls</i>						
ASIS1	China	2.90	11.05	5.72	55.833 ^{***}	38.017 ^{***}
LF324	France	4.06	4.33	0.19	0.061 ^{ns}	1.121 ^{ns}
Listada de Gandía	Spain (commercial)	0.76	2.41	0.16	2.288 ^{ns}	0.043 ^{ns}
SUDS5	Cuba	3.30	4.91	1.13	2.179 ^{ns}	0.029 ^{ns}
Mean		2.76	5.67			
Global mean		2.93	4.36			
Average SE ^a		0.90	0.62			

ns, *, **, *** Non-significant or significant at $P < 0.05$, 0.01 or 0.001, respectively.

^aAverage standard error for individual accessions calculated from the ANOVA.

For some accessions it was not possible to discern if they had either static or dynamic stability for yield because the difference among environments was not high enough to do this. Accessions with β negative values indicate that they have a better performance in the open air, while those with very high β values perform much better in greenhouse. Clearly some accessions were not well adapted to the greenhouse, and surprisingly, some of them had an excellent performance in the greenhouse. High yields in either the open field or greenhouse of some accessions, indicates that some of them could be useful without further breeding. Other germplasm screening works have also identified promising materials in collections of local varieties (Chadha 1993). Important accession x environment interaction indicates that breeders may take advantage of the specific adaptation to different environments when making their breeding programmes.

Morphological characterization

A wide range of variation for most descriptors studied was found in the collection of Spanish local varieties studied, which is in agreement with our previous findings (Prohens et al. 2003) using other Spanish materials. However, in general, all varieties had vigorous plants, relatively few prickles, and fruits with a fruit weight above 100 g, which are typical traits of the modern *S. melongena* varieties (Lester and Hasan 1991). The growing environment had some impact on several morphological traits (Table 2). Plant and flower anthocyanins intensity and fruit size were greater in the open field, while number of flowers per inflorescence, prickliness, fruit pedicel length and the ratio fruit length/fruit breadth were greater in the greenhouse. These results, especially those related to fruit size and shape and fruit calyx prickliness have important commercial implications and should be taken in account when growing in greenhouse materials evaluated in the open field and vice versa.

Table 2. Morphological traits for which a significant difference was detected between open field and greenhouse cultivation and value of the Student's *t* statistic for paired comparisons.

Trait	Trait value		<i>t</i> value
	Open field	Greenhouse	
Shoot tips anthocyanins intensity (0=absent; 9=very strong)	4.81	2.33	5.465***
Leaf prickles (0=none; 9=very many)	0.56	2.44	-5.090***
Number of flowers per inflorescence	1.26	1.93	-5.099***
Corolla colour (1=greenish white; 9=bluish violet)	7.00	5.17	3.238**
Fruit pedicel length (cm)	7.70	9.85	-2.435*
Fruit length (cm)	18.62	16.89	2.955**
Fruit breadth (cm)	8.03	5.91	6.763***
Fruit length/fruit breadth	2.68	3.28	-4.374***
Fruit calyx prickles (0=none; 9=very many (>30))	1.92	5.00	-7.931***

*, **, *** Significant at $P < 0.05$, 0.01 and 0.001 , respectively.

Molecular data

The UPGMA phenogram made with the AFLP data (Figure 1) shows that the control varieties, despite their different origins, are not genetically differentiated from the Spanish accessions, indicating that the latter contain considerable diversity. However, the bootstrap value for most nodes of the tree was low (below 50%), suggesting that the relationships among accessions have followed a network model rather than a tree model, as usual when considering relationships within a species (Crandall and Templeton, 1996).

The total gene diversity (H_T) for the collection studied was $H_T=0.056$. Similar studies made with other *Solanaceae* vegetable crops in our laboratory using similar AFLP protocols seem to indicate that *S. melongena* group H has a genetic diversity similar to cultivated and weedy tomatoes (*Lycopersicon esculentum* Mill. and *L. esculentum* var. *cerasiforme* (Dun.) Gray), which had a $H_T=0.063$, but lower than pepino (*Solanum muricatum* Aiton), which had a $H_T=0.091$. This suggests that, as occurred with the tomato, eggplant suffered several bottlenecks during domestication (Lester and Hasan 1991), which has resulted in a low diversity of the crop (Karihaloo et al. 1995).

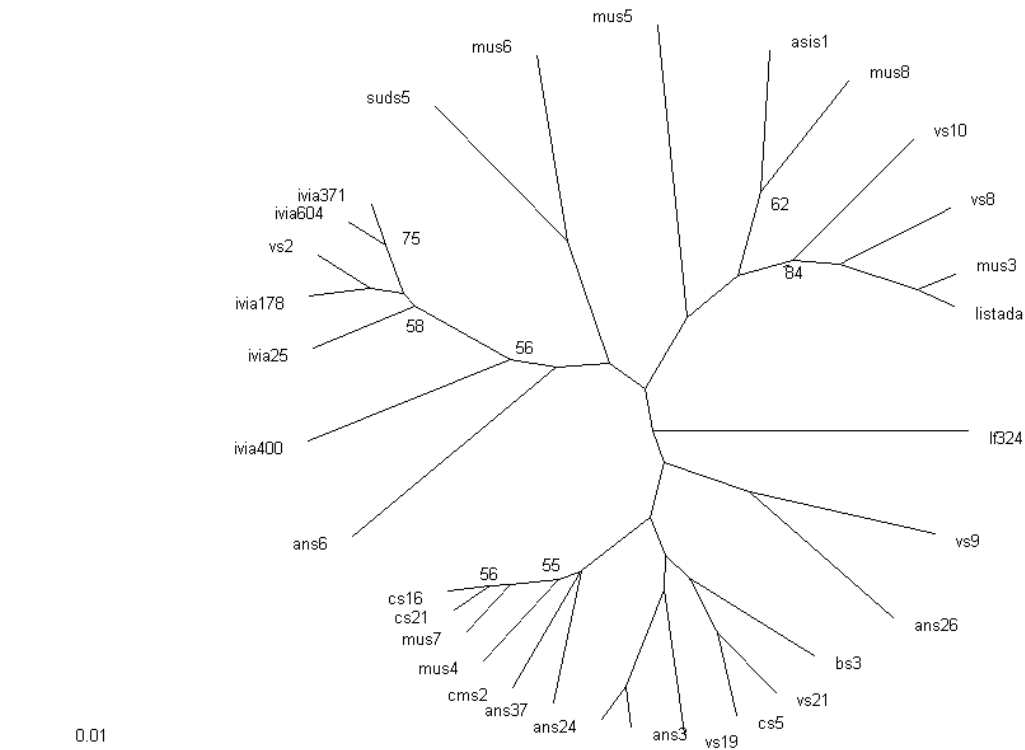

Figure 1. UPGMA phenogram of 31 accessions of *Solanum melongena* based on AFLPs. Phenetic relationships were derived from Dice-AFLP-based pairwise genetic distance. Bootstrap values (percentages; 1000 replications) are indicated at nodes having values above 50.

Conclusions

The results obtained show that Spanish eggplants display considerable morphological and molecular diversity and indicates that these materials may be useful for eggplant breeding, both for greenhouse or open field cultivation. The important accession x environment interaction observed indicates that breeding efforts should be directed at selecting clones adapted to specific growing environments.

Acknowledgements

This research has been financed by EU (RESGEN PL98-113) and Ministerio de Ciencia y Tecnología (RF02-029 and AGL2003-03949). Authors thank V. Valls and M. Muñoz for their help in the characterization trials.

References

- Anonymous. 1997: Análisis de la evolución varietal en berenjenas. *Horticultura Internacional* 17: 23-26.
- Chadha, M.L. 1993. Improvement of brinjal. In: Chadha, K.L.; Kalloo, G. (eds). *Advances in Horticulture Vol. 5 – Vegetable crops: part 1*. Malholtra Publishing House, New Delhi, India, p. 105-135.
- Choudhoury, B. 1995: Eggplant. In: Smartt, J.; Simmonds, N.W. (eds). *Evolution of crop plants*. Longman Scientific & Technical, Essex, UK, p. 464-465.
- Crandall, K.A.; Templeton, A.R. 1996: Applications of intraspecific phylogenetics: problems and solutions. In: Harvey, P.H.; Brown, A.J.L.; Smith, J.M. (eds). *New uses for new phylogenies*. Oxford University Press, Oxford, UK, p. 81-99.
- Dabholkar, A.R. 2001: *Elements of biometrical genetics*. Concept Publishing Co., New Delhi, India.
- Daunay, M.C. 1996. Aubergine? Aubergines!. *PHM Revue Horticole* 374: 48-49.
- Daunay, M.C. ; Lester, R.N. ; Ano, G. 1997: Les aubergines. In: Charrier, A.; Jacquot, M.; Hamon, S.; Nicolas, D. (eds). *L'amélioration des plantes tropicales*. Cirad et Orstom, Montpellier, France, p. 83-107.
- Kang, M.S. 1998: Using genotype-by-environmental interaction for crop cultivar development. *Advances in Agronomy* 62: 199-252.
- Karihaloo, J.L.; Brauner, S.; Gottlieb, L.D. 1995. Random amplified polymorphic DNA variation in the eggplant, *Solanum melongena* L. (Solanaceae). *Theoretical and Applied Genetics* 90: 767-770.
- Lester, R.N.; Hasan, S.M.Z. 1991: Origin and domestication of the brinjal eggplant, *Solanum melongena*, from *S. incanum*, in Africa and Asia. In: Hawkes, J.G.; Lester, R.N.; Nee, M.; Estrada, N. (eds). *Solanaceae III: taxonomy, chemistry, evolution*. The Linnean Society of London, London, UK, p. 369-387.
- Nuez, F. 1995: Desarrollo de nuevos cultivares. In: Nuez, F. (ed). *El cultivo del tomate*, Mundi-Prensa, Madrid, Spain, p. 625-669.
- Nuez, F.; Gil, R.; Costa, J. 1996: *El cultivo de pimientos, chiles y ajíes*. Mundi-Prensa, Madrid, Spain.
- Nuez, F.; Prohens, J.; Blanca, J.M. 2004: Relationships, origin, and diversity of Galápagos tomatoes: implications for the conservation of natural populations. *American Journal of Botany* 91: 86-99.
- Nuez, F.; Prohens, J.; Valcárcel, J.V.; Fernández de Córdova, P. 2002: Colección de semillas de berenjena del Centro de Conservación y Mejora de la Agrodiversidad Valenciana. Ministerio de Ciencia y Tecnología, Madrid, Spain.
- Prohens, J.; Nuez, F. 2001: Variedades tradicionales de berenjena en España. *Vida Rural* 130: 46-50.
- Rodríguez-Burruezo, A.; Prohens, J.; Nuez, F. 2002: Genetic analysis of quantitative traits in pepino (*Solanum muricatum*) in two growing seasons. *Journal of the American Society for Horticultural Science* 127: 271-278.

Assessment of genetic relationships in the genus *Capsicum* using different DNA marker systems.

Kochieva E.Z.^{1,2}, Ryzhova N.N.^{1,2}, van Dooijeweert W.³, Boukema I.W.³, Arens P.¹

¹Plant Research International, P.O. Box 16, 6700 AA Wageningen, The Netherlands

²N.I.Vavilov Institute of General Genetics, 119991 Moscow, Russia; kochieva@vigg.ru

³Centre for Genetic Resources, P.O. Box 16, 6700 AA Wageningen, The Netherlands

Abstract: AFLP, RAPD and ISSR marker systems were used to determine genetic variation and phylogenetic relationships within the genus *Capsicum*. In total, 1921 bands were used in the genome analysis of 61 accessions representing 11 species of the *Capsicum* genus. AFLP, RAPD and ISSR dendrograms were congruent but not identical in the clustering of the analyzed *Capsicum* accessions. The genetic data confirmed the recognition of *C. frutescens* and *C. chinense* as separate species with high bootstrap values. Our study further supports the recognition of *C. praetermissum* as a separate species inside the *C. baccatum* complex. Molecular markers reveal high genetic similarities of *C. pubescens* with *C. eximium* and *C. cardenasii*. *C. tovarii* is found to be genetically rather closed to *C. baccatum* (AFLP, RAPD data) or *C. praetermissum* (ISSR data). Molecular data support the close relationships of *C. galapagoense* with *C. frutescens* (RAPD analysis) and *C. annuum* (ISSR analysis) and this species can therefore be considered to be a member of the *C. annuum* complex. Combining the results based on molecular data obtained in this study and results obtained by other researchers an informal classification of *Capsicum* can be proposed.

Keywords: pepper, genetic diversity, *Capsicum* phylogeny, chilli pepper.

Introduction

The genus *Capsicum* consists of 22-27 currently recognised wild and domesticated species, differentiation of which is mainly based on morphological characters, especially on flower morphology. Numerical analysis of morphological characters has been used for taxonomic identification and determination of relationships within the genus *Capsicum* (Pickersgill, 1979, Eshbaugh, 1993). However, a number of the *Capsicum* species designations suffer from the existence of taxonomically conflicting characters (Pickersgill, 1979). Moreover, the recognition of distinct species in some taxa with a common ancestral gene pool (e.g. *C. annuum*, *C. frutescens*, *C. chinense*) is complicated because of overlapping morphology (Pickersgill, 1979). The most common *Capsicum* species both domesticated and wild belong to one of three species-complexes: the ***C. annuum* complex** - combining species *C. annuum*, *C. chinense* and *C. frutescens*, with white flowers, the ***C. baccatum* complex** - *C. chacoense*, *C. praetermissum* and *C. baccatum* sensu lato with yellowish spots on white flowers and the purple flowered ***C. pubescens* complex** - *C. eximium*, *C. cardenasii* and *C. pubescens*.

For a number of species their taxonomic positions within the *Capsicum* complexes remain uncertain. For instance, according to isozyme analysis the white-flowered *C. chacoense* seems to be more closely related to the purple-flowered *pubescens* complex (McLeod et al. 1983), though some seed protein analysis result in close relationships with species of the *C. annuum* complex (Panda et al., 1986). Also the inclusion of *C. pubescens* into one complex with *C. eximium* and *C. cardenasii* is not supported by nucleotide polymorphism data (Walsh & Hoot, 2001). Furthermore, some of the newly described species have not yet univocally been included into the existing classification. For example, there is no single opinion about the placement of *C. tovarii* (McLeod et al. 1983, Walsh & Hoot, 2001) and *C. galapagoense* within the *Capsicum* complexes. Multi-

locus molecular markers techniques may provide useful information to resolve these issues.

Molecular markers such as AFLP, RAPD and ISSR are increasingly being used in phylogenetic analysis. They are highly reliable in measuring genetic diversity and may better reflect actual genetic differences than morphological information. The objectives of this study were to detect AFLP, RAPD and ISSR genetic variation within the genus *Capsicum* and to determine phylogenetic relationships between *Capsicum* species by using different molecular markers.

Material and methods

Plant material

Sources and origins of the accessions are described in Table 1. Plant material was obtained from the Centre for Genetic Resources the Netherlands (CGN), the Russian Institute of Plant Industry (VIR) and the Russian Scientific Research Institute for Selection and Seed Growing of Vegetable Cultures (VNIISOK), The origins of the chosen accessions correspond with the natural range of the genus. Single accessions of *Lycopersicon*, *Physalis* and *Nicotiana* were taken as outgroup. A number of *C. annuum* cultivars were also included into the analysis.

Table 1: List of *Capsicum* accessions.

Sample nr	Species	Accession nr	Origin
1	<i>C. galapogoense</i>	CGN22208	
2	<i>C. eximum</i>	CGN21502	
3	<i>C. cardenasii</i>	CGN20497	
4	<i>C. chacoense</i>	CGN22869	Argentina
5	<i>C. chacoense</i>	CGN20493	Argentina
6	<i>C. chacoense</i>	CGN20509	
7	<i>C. chacoense</i>	CGN21477	Argentina
8	<i>C. tovarii</i>	CGN22876	Peru
9	<i>C. praetermissum</i>	CGN22794	Brazil
10	<i>C. praetermissum</i>	CGN22795	-
11	<i>C. praetermissum</i>	CGN20805	Brazil
12	<i>C. praetermissum</i>	CGN19198	
13	<i>C. baccatum</i> var. <i>pendulum</i>	VNISSOK307	
14	<i>C. pubescens</i>	CGN22796	Guatemala
15	<i>C. pubescens</i>	CGN22797	
16	<i>C. pubescens</i>	CGN22798	
17	<i>C. pubescens</i>	CGN924342	Peru
18	<i>C. baccatum</i>	CGN22858	Brazil
19	<i>C. baccatum</i> var. <i>baccatum</i>	CGN22786	Bolivia
20	<i>C. baccatum</i>	VNISSOK 315	
21	<i>C. baccatum</i>	VNISSOK 322	
22	<i>C. baccatum</i>	VIR5402	France
23	<i>C. frutescens</i>	CGN22790	Mexico
24	<i>C. frutescens</i>	CGN22792	Peru
25	<i>C. frutescens</i>	CGN22799	Guatemala
26	<i>C. frutescens</i> cv Lombok	CGN22817	Indonesia
27	<i>C. frutescens</i>	CGN22861	Philippines

Sample nr	Species	Accession nr	Origin
28	<i>C. frutescens</i>	VNISSOK 301	
29	<i>C. frutescens</i>	VNISSOK 331	
30	<i>C. chinense</i>	CGN22788	
31	<i>C. chinense</i>	CGN22855	Suriname
32	<i>C. chinense</i>	VNISSOK323	
33	<i>C. chinense</i>	VNISSOK324	
34	<i>C. annuum</i> var. <i>conicum</i>	VIR2847	Ghana
35	<i>C. annuum</i> var. <i>conicum</i>	VIR 5968	Laos
36	<i>C. annuum</i> var. <i>conicum</i>	VIR 4683	Colombia
37	<i>C. annuum</i> var. <i>conicum</i>	VNISSOK327	
38	<i>C. annuum</i> var. <i>angulosum</i>	VIR2382	India
39	<i>C. annuum</i>	CGN22770	Nicaragua
40	<i>C. annuum</i>	CGN22771	Mexico
41	<i>C. annuum</i>	CGN22772	Guatemala
42	<i>C. annuum</i>	CGN22774	Guatemala
43	<i>C. annuum</i>	CGN22775	Guatemala
44	<i>C. annuum</i>	CGN22800	Guatemala
45	<i>C. annuum</i>	CGN22805	Ethiopia
46	<i>C. annuum</i> cv. Bruinsma Wonder		Netherlands
47	<i>C. annuum</i> cv. Polubabura		Yugoslavia
48	<i>C. annuum</i> cv. N6br30k		Japan
49	<i>C. annuum</i> cv. Red skin		Poland
50	<i>C. annuum</i> cv. Zdorovie		Russia
51	<i>C. annuum</i> cv. Granat		Czech Republic
52	<i>C. annuum</i> cv. Mavr		Moldova
53	<i>C. annuum</i> cv. Salad Festival		United Kingdom
54	<i>C. annuum</i> cv. Balko Linkov		Bulgaria
55	<i>C. annuum</i> cv. Marconi pepper		Italy
56	<i>C. annuum</i> cv. Chimes		Netherlands
57	<i>C. annuum</i> cv. Boria		Netherlands
58	<i>C. annuum</i> cv. Yellow Bell		Canada
59	<i>C. annuum</i> cv. Agapovskii		Russia
60	<i>C. annuum</i> cv. Rodnik		Russia
61	<i>C. annuum</i> cv. Beglitzkii		Russia

DNA analysis

Because of technical reasons AFLP analysis was performed on DNA of 57 *Capsicum* accessions. AFLP analysis was performed as described by standard procedures. Selective amplification was carried out using 6 different combinations of *EcoRI* and *MseI* primers having three selective nucleotides at 3' ends. For RAPD analysis, out of the 58 standard 10-mer primer sets (Operon Technologies, USA) that were tested, 11 primers showed reproducible and clearly scorable polymorphic fragments. These 11 primers were used for fingerprinting of the whole set of *Capsicum* accessions. In ISSR analyses 15 primers anchored on their 3' end with 1-2 nucleotides were used. ISSR reaction mixtures and

protocols were as described by Nagaoka and Ogihara (1997). All reactions were repeated twice to ensure repeatability of scorings.

Data analysis

Genetic similarity was calculated using the Jaccard similarity coefficient. Clustering analysis was performed using UPGMA (STATISTICA software package). The stability of clustering was confirmed by using Nei and Li measures and Neighbour-joining analysis on 1000 re-sampling of the data (TREECON software package). Principal component analyses (PCA) were performed using STATISTICA and NTSYS software packages.

Results and discussion

In total, 1921 polymorphic bands (1112 for AFLP, 435 for RAPD and 374 for ISSR) were used in the genetic analysis of 61 accessions representing 11 species of the *Capsicum* genus. Levels of intra- and interspecific genetic polymorphism determined, by using the different marker systems, were similar. Genetic similarity values (GS) within *Capsicum* were between 0.99-0.71 for AFLP, 0.99-0.76 for RAPD and 0.95-0.69 for ISSR analyses. Interspecific GS values did not exceed 0.87. AFLP markers were more efficient in distinguishing among *Capsicum* accession, especially among *C. annuum* cultivars than RAPDs. ISSRs revealed higher intraspecific diversity levels than those detected by RAPD and AFLP markers. AFLP, RAPD and ISSR dendrograms were congruent but not identical in the clustering of the analysed *Capsicum* accessions. Analysis of the obtained *Capsicum* dendrograms shows that the accessions mainly form three big clusters corresponding to the main *Capsicum* complexes (Fig. 1). Within these clusters accessions which represent one species form separate subclusters.

In the AFLP, RAPD and ISSR dendrograms the species of the *C. annuum* complex are clustering separately from the other *Capsicum* species. Similarly in the PCA analysis the accessions of the *C. annuum* complex form a clearly separate but not very dense group (data not shown). Within the *C. annuum* complex all three molecular methods used in this study distinguish the three species that form the complex and in all dendrograms accessions of *C. annuum*, *C. frutescens* and *C. chinense* fall into separate well distinguishable species-specific subclusters. AFLP and RAPD reveal closer relationships between *C. frutescens* and *C. chinense*, than with *C. annuum*. This result agrees with the PCA data where accessions of *C. frutescens* and *C. chinense* form two very close dense groups well separated from the major group of *C. annuum* accessions. In spite of the fact that *C. frutescens* and *C. chinense* form an overlapping morphological continuum (Pickersgill, 1979, Eshbaugh, 1993) the results presented here and additional detail analysis of diversity in these species (Kochieva, unpublished data) inclined to confirm the recognition of *C. frutescens* and *C. chinense* as separate species. The majority of *C. annuum* accessions form a broad cluster. The genetic similarity within this cluster is high (0.95- 0.89) especially within the cultivars. Wild accessions of *C. annuum* (nrs. 39, 41-43) show more diversity (0.05-0.1) than cultivated varieties (0.01-0.05).

The molecular analysis detected some possible errors in morphologically based assignment of accessions. Most of the misidentifications include accessions of the *C. annuum* complex. For instance, accessions 22, 28 and 29 according to their position on dendrograms and PCA plots seem to be of interspecific hybrid origin instead of a true species. Similarly, *C. pubescens* accession 15 is clustering with *C. praetermissum* with 100% bootstrap.

The position of *C. galapagoense* within the genus *Capsicum* has not been well defined and placement of this species has never been properly studied before. Morphologically *C. galapagoense* is very distinct from other species and the only hybrids

were obtained with *C. annuum* (Pickersgill, 1980). The only molecular analysis, based on nucleotide polymorphism of several genes, includes *C. galapagoense* in a weakly supported *C. annuum* complex (Walsh and Hoot, 2000). Our molecular data strongly support close relationships of *C. galapagoense* with *C. frutescens* (RAPD analysis) and *C. annuum* (ISSR analysis) and we therefore consider *C. galapagoense* to be a member of the *C. annuum* complex.

C. tovarii is a *Capsicum* species that has been identified recently and not many studies have included *C. tovarii* accessions. The studies based on protein analyses and analysis of *atpB-rbcL* and *waxy* genes sequences do not show a close relationship of *C. tovarii* to any of the other pepper species (McLeod et al., 1983, Walsh & Hoot, 2001). However, according to our molecular data *C. tovarii* is found to be genetically close to *C. baccatum* (AFLP data) or *C. praetermissum* (ISSR data). These results suggest that *C. tovarii* should be included into the *C. baccatum* complex (98% of bootstrap value for AFLP). Hybridisation studies and meiotic chromosome behaviour (Tong & Bosland, 1999) also support this.

Our data support for the maintenance of *Capsicum pubescens* into the *C. pubescens* complex, combining species with purple coloured flowers that also includes the wild species *C. eximium* and *C. cardenasii*. These data also lend to the conclusion that *C. eximium* and *C. cardenasii* can be probable ancestors of or have a common ancestral gene pool with domesticated *C. pubescens*. Our data confirm the results of isozyme and hybridization studies (McLeod et al., 1983, Eshbaugh, 1993) although according to the analysis of non-coding regions of *atpB-rbcL* and *waxy* genes the position of *C. pubescens* within *Capsicum* cannot be properly assigned (Walsh & Hoot, 2001). A high bootstrap value of 95% supports the recognition of a separate taxonomic status of *C. praetermissum*. On the PCA plot *C. praetermissum* accessions inside the *C. baccatum* complex form a distinct group placed apart of *C. baccatum*, while the *C. baccatum* var. *pendulum* accession and *C. baccatum* var. *baccatum* accessions fall into one dense undistinguishable group.

According to chromosome banding pattern *C. chacoense* was described as a species (equally) distinct from all *Capsicum* complexes (Moscone et al., 1993). Using protein analysis it was shown that *C. chacoense* appeared not to belong to any of the white flower complexes and more resembled the purple-flowered *C. pubescens* group (McLeod et al., 1983). The analysis of the seed proteins nevertheless resulted in clustering of *C. chacoense* with *C. chinense* and *C. annuum* (Panda et al., 1986). The AFLP and RAPD results presented here are consistent with the data of the gene nucleotide analyses (Walsh & Hoot, 2001) showing that *C. chacoense* is related to the members of the *C. baccatum* complex. This is supported by a high bootstrap value (89%) based on the AFLP data. In contrast, based on ISSR data *C. chacoense* clusters within the *C. annuum* complex although with low bootstrap values (25%). Furthermore, PCA analysis also suggests that the *C. chacoense* accession is related to accessions of *C. pubescens*. So the relationship between *C. chacoense* and the other *Capsicum* species is less clear and the placement of *C. chacoense* into any existing *Capsicum* complex may not be justified. The position of *C. chacoense* may be clarified by additional analysis using more accessions.

Combining the results based on molecular data obtained in this study and by other researchers (McLeod et al., 1983, Eshbaugh, 1993, Paran et al., 1998, Rodriguez et al., 1999, and others) an informal classification of *Capsicum* can be proposed and the analysed species can be grouped in several complexes:

***C. annuum* complex** combining species *C. annuum*, *C. chinense*, *C. frutescens*, *C. galapagoense*

***C. baccatum* complex** - *C. praetermissum*, *C. baccatum sensu lato*, *C. tovarii*

***C. pubescens* complex** - *C. eximium*, *C. cardenasii*, *C. pubescens*.

***C. chacoense* complex** - *C. chacoense*

Such grouping may indicate the existence of several independent ancestral lines or gene pools that lead to the present *Capsicum* species.

References

- Eshbaugh W.H., 1993: Peppers: History and exploitation of a serendipitous new crop discovery. p. 132-139. In: J. Janick and J.E. Simon (eds.), New crops. Wiley, New York
- McLeod MJ, Guttman SI, Eshbaugh WH. 1982. Early evolution of chili peppers (*Capsicum*). *Econ Bot* 36: 361-368.
- McLeod, M.J., S.I. Guttman, W.H. Eshbaugh, and R.E. Rayle 1983: An electrophoretic study of the evolution in *Capsicum* (Solanaceae). *Evolution* 37:562-574.
- Moscone EA., M Lambrou, AT Hunziker, F Ehrendorfer 1993: Giemsa C- banding karyotypes in *Capsicum* (Solanaceae). *Plant Syst Evol*, 186:213-229.
- Nagaoka, T., and Y. Ogihara. 1997. Applicability of inter-simple sequence repeat polymorphisms in wheat for use as DNA markers in comparison to RFLP and RAPD markers. *Theor Appl Genet* 94:597-602.
- Panda R.C., Aniel Kumar O, Raja Rao K.G. 1986: The use of seed protein electrophoresis in the study of phylogenetic relationships in Chilli pepper (*Capsicum* L.). *Theor Appl Genet* 72:665-670.
- Paran I, Aftergoot E, Shifriss C. 1998: Variation in *Capsicum annuum* revealed by RAPD and AFLP markers. *Euphitica* 99:167-174.
- Pickersgill, B., C.B. Heiser, Jr., J. McNeill. 1979: Numerical taxonomic studies on variation and domestication in some species of *Capsicum*, p. 679-700. In: J.G. Hawkes, R.N. Lester, and A.D. Skelding (eds.). *The biology and taxonomy of the Solanaceae*. Academic Press, London.
- Prince JP, Lackney VK, Angeles C, Blauth JR, Kyle MM 1995: A survey of DNA polymorphism within the genus *Capsicum* and the fingerprinting of pepper cultivars. *Genome*, 38: 224-231.
- Rodriguez JM, Berke T., Engle L., Nienhuis J. 1999: Variation among and within *Capsicum* species revealed by RAPD markers *Theor Appl Genet* 99:147-156.
- Tong N & Bosland PW., 1999: *Capsicum tovarii*, a new member of the *Capsicum baccatum* complex. *Euphitica* 109: 71-77.
- Walsh BM & B Hoot. 2001: Phylogenetic relationships of *Capsicum* (Solanaceae) using DNA sequences from two noncoding regions: the chloroplast *atpB-rbcL* spacer region and nuclear *waxy* intron. *Int.J.Plant Sci.* 162:1409-1418.

Figure 1. Dendrogram based on the AFLP data, using Jaccard's coefficient and UPGMA clustering. Numbers listed in Table 1 labels the samples.

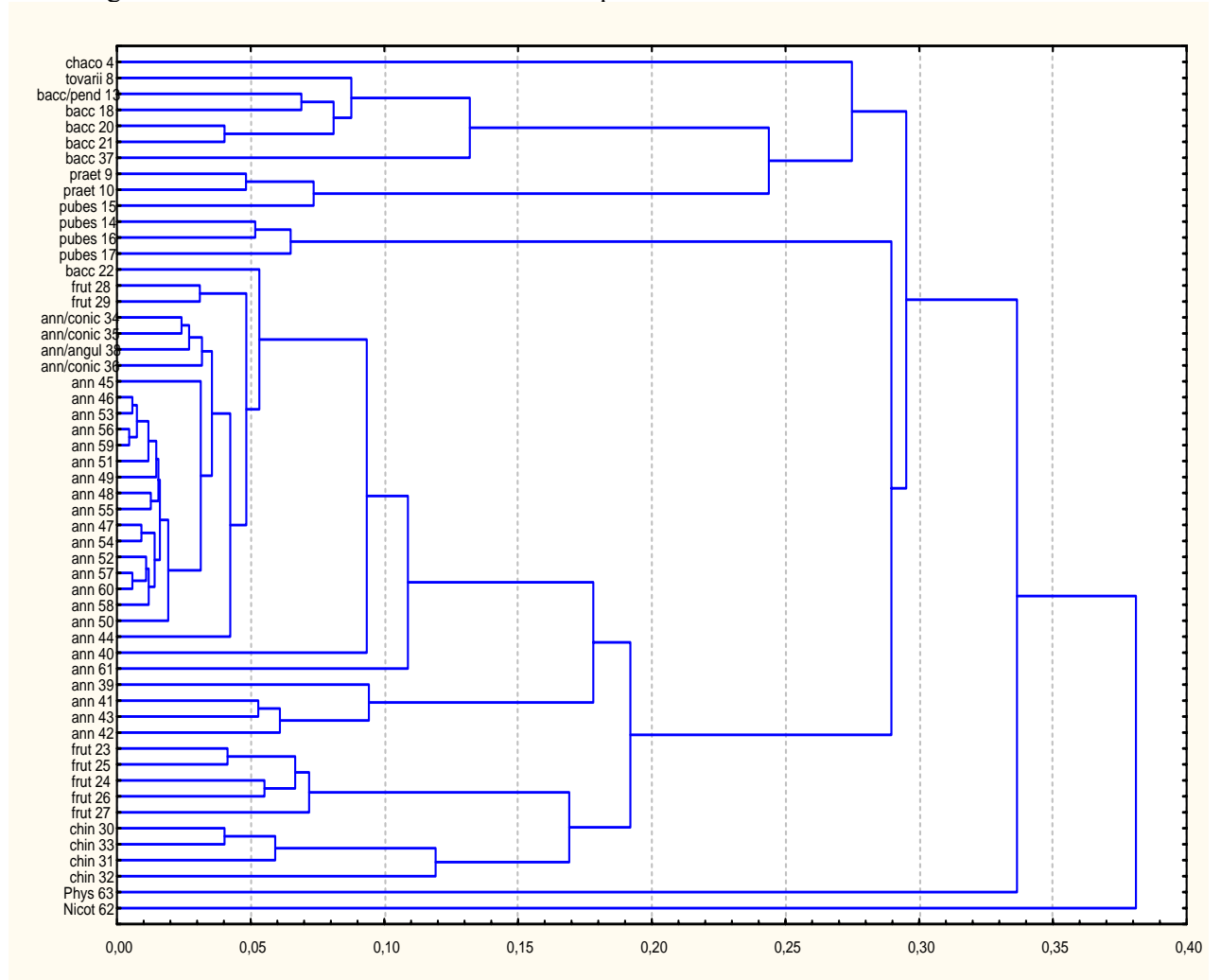

Collection and Characterization of *Capsicum annum* (Sweet pepper) in Nigeria

O.A. Adetula and J.O. Babatola

National Horticultural Research Institute, p.m.b. 5432, Idi-Ishin, Ibadan, Nigeria,
Olagorite@yahoo.com

Abstract: *Capsicum annum* (sweet pepper) is a crop of tremendous nutritional importance in Nigeria. It is consumed as spices in side dishes, fried rice, or as soup. *Capsicum annum* is widely grown in all the ecological zones namely North East, North west, North Central, South South, South East and South West, but the production and productivity varies across the different ecology. The Northern parts of Nigeria, Kano, Kaduna, Sokoto, Borno and Gombe are the major growing areas of *Capsicum annum*. The productivity of Sweet pepper in the South is much below the optimum, because of the agroclimatic situations. With a view to select and develop improved *Capsicum* varieties suitable for cultivation in the Southern parts of Nigeria, a study was undertaken.

Fruits of *Capsicum* (sweet pepper) were collected from different agro ecological zones of Nigeria and processed to seeds. A total of one hundred and fifty accessions were characterized, evaluated and conserved at the National Horticultural Research Institute, Ibadan Nigeria. The trials were conducted primarily in the Southern parts of Nigeria. Seedling of *C. annum* were transplanted after five weeks of sowing in the nursery at the spacing of 40cm by 75cm. Each plot (2m X 2m) had ten stands of pepper and was replicated three times in a randomized complete block design. Mineral fertilizers N.P.K (26:12:0) were applied one month after transplanting at the rate of 224kg/ha. Evaluation were recorded for fruit shape, colour, size, flowers per truce and position of stigma. Two major flower colour such as cream and white were observed. The flower size varies from small, medium to big. Fifty percent (50% of the accession were of thew medium size and the fruit diameter was 50mm. Ninety eight percent(98%) of the flowers produced had protruded stigma. The accessions were grouped into classes using the following characters: medium plant, early flowering, long flowering duration, long fruiting duration, high number of fruit/plant, fruit abortion, cracking/split fruit. Wide variability existed among accessions, most of the accessions were red in colour .The blossom end is a stable character for grouping and characterizing the *C. annum*. The other good characters are ridges and fruit shape which are either pointed or block. Pollen fertility of the capsicum accession were also carried .Pollen from the matured anthers stained with 1% acetocarmine and glycerine were observed under the microscope. Seventy percent (70%) of the accessions were well stained and regular in shape. From this study it can be concluded that ten accessions: DT96/426, DT95/279,DT96/346, DA97/426, DT95/144, DT95/78, DT97363, DA97/416, DT97/186-1and DA97/409 were suitable for agroclimatic conditions of the Southern parts of Nigeria.

Genetic variability studies in Chilli (*capsicum annuum* L.)

N. Basavaraja¹, R.M. Hosamani² and Krishna. C. Ukkund³

^{1,2,3}Department of Horticulture, University of Agricultural Sciences, Dharwad –580005, Karnataka, Indi, ¹E-mail: rajapotchi@rediffmail.com

Abstract: Chilli (*Capsicum annuum* L.) is one of the major spice and vegetable crop of India. Chilli is a native of South America and globally, grown over 1.4 million ha producing about 18.8 m tons of fresh and dry fruits. In India, chilli is being grown in an area of 0.9 m. ha with an annual production of 1.01 m. tons and productivity is low compared to the world average(1.12 t/ha). Sixteen different accessions of chilli genotypes having different characters were evaluated in randomized block design with three replications at the Division of Horticulture, University of Agricultural Sciences, Dharwad, Karnataka, India.

Genetic variability in sixteen different indigenous genotypes of chilli were studied for 5 important characters *viz.*, plant height, number of branches, number of fruits per plant, plant yield (kg/plot), and yield t/ha. The analysis of variance revealed a significant and high degree of variability for all the characters studied. Phenotypic variance showed higher value than the genotypic variance indicating greater influence of environment. The higher estimates of genotypic and phenotypic coefficient of variation were observed for fruit yield (42.71 & 57.49 kg/plot) and fruit yield t/ha (59.55 & 77.69) this indicates presence of considerable variability and offer lot of scope for selection. High heritability along with high genetic advance as percent mean was found for fruit yield kg/plot and fruit yield tons/ha (55.20 & 63.49) and (59.55 & 94.10) respectively which indicates the additive gene effect regulating their inheritance. The character number of fruits/plant showed medium to high GCV (40.74), PCV (58.56), heritability (48.40) with GAM of 58.38 indicating the additive and dominant gene effect and scope for simple selection followed by hybridization.

Considering the present study it could be concluded that selection of individual plants based on number of fruits / plant, fruit yield/plot which showed moderate GCV, high heritability and high GAM might be effective for crop improvement in chilli through selection. This could be achieved by simple methods like pure line selection or mass selection following hybridization in early generation.

Characterization of different pepper genotypes collected from coastal regions of Turkey

Davut Keles(1), Suleyman Karagul(1), Saadet Buyukalaca(2)

Alata Horticultural research Institute Erdemli-Mersin-TURKEY (1)

Cukurova University, Faculty of Agriculture, Department of Horticulture Balcali-Adana-TURKEY (2)

Capsicum spp. is among the most important vegetable and spice crops and cultivated worldwide. Pepper has great significance in some countries such as China, Mexico, Turkey, India and Hungary. The enormous genetic diversity available for pepper breeding offers a potential for the development of new varieties and hybrids.

In Turkey, there are also big genetic diversity and can be facilitated for the breeding of new varieties. For this aim, a gene pool has been formed by collecting pepper genotypes grown in the coastal region of Turkey. Seventy different genotypes, which were chosen from gene pool, have been evaluated by using 30 morphological characters which are formed by modifying IPGRY and UPOV. Data were analyzed statistically using SAS computer program. The results showed that there are 8 main clusters when fruit and leaf shapes and weigh of 1000 seeds were considered.

Genetic diversity among *Capsicum chinense* Jacq. accessions revealed by different molecular marker systems

Kochieva E.Z.^{1,2}, Ryzhova N.N.^{1,2}, van Dooijeweert W.³, Boukema I.W.³, Arens P.¹

¹Plant Research International, P.O. Box 16, 6700 AA Wageningen, the Netherlands

²N.I.Vavilov Institute of General Genetics, 119991 Moscow, Russia; kochieva@vigg.ru

³Centre for Genetic Resources, P.O. Box 16, 6700 AA Wageningen, the Netherlands

AFLP, RAPD, and ISSR molecular marker systems were used to estimate the level of genetic polymorphism among a wide variety of *C. chinense* accessions from across the natural range of the species. We studied the use of these molecular marker systems for species delimitation of *C. chinense* in the *C. annuum* complex and their ability to detect accession duplications in genebank collections. Furthermore, we compared the use of the different marker systems in evaluating genetic diversity in *C. chinense*. In total 64 *C. chinense* accessions mainly from CGN gene bank (Wageningen, The Netherlands) were taken into the analysis. In total 685 polymorphic bands (330 AFLP, 202 RAPD, 153 ISSR) were generated. The comparison of the different marker systems in a Mantel test shows their equality in evaluating genetic diversity in *C. chinense*. The defined levels of genetic similarities in *C. chinense* were high and come to 0.83 for AFLP, 0.87 for RAPD, and 0.91 for ISSR. Low levels of genetic polymorphism between accessions of *C. chinense* may be caused by founder effects at domestication (Pickersgill, 1997) combined with self-pollination which is rather strong in domesticated *Capsicums* (Eshbaugh, 1975).

UPGMA clustering and principal co-ordinate analysis based on genetic similarity matrixes were used to evaluate genetic relationships among *C. chinense* accessions. Clustering type of most of the accessions based on the three marker systems data was highly congruent. Clustering analysis of *C. chinense* accessions show that they form several groups. The majority of accessions (68%) fall into one large cluster - "*chinense*" cluster. GS values within this cluster were very high (0.89- 0.99). *C. chinense* accessions of the main cluster fall into two subclusters correspondingly to their origin from Atlantic or Pacific coasts of South America. Another cluster that is branching on the level of 0.67, called "*annuum*" cluster, consists of the accession of *C. annuum* (cv. Beglitskii) and six accessions of *C. chinense*. Genetic similarity (GS) values in this cluster ranged from 0.81 to 0.96. Several accessions including the *C. frutescens* accession did not cluster and formed separate branches.

Molecular data support the close relationship between species of the *C. annuum* complex. *C. chinense* was found to be closer to *C. frutescens* than to *C. annuum*. The latter observation was also supported in genetic analysis of species relationships in a wide set of *Capsicum* species.

Amplified fragment length polymorphism (AFLP) for genetic diversity assessment in Italian sweet pepper (*Capsicum annuum* L.) germplasm.

G. Nervo¹, E. Portis², L. Barchi² and S. Lanteri^{2,3}

¹Research Institute for Vegetable Crops, via Pautlese 28, 26836 Montanaso Lombardo (Lodi), Italy. ²Di.Va.P.R.A. Plant Genetics and Breeding, University of Turin, via L. da Vinci 44, I-10095 Grugliasco (Turin), Italy. ³sergio.lanteri@unito.it

In the last decades a drastic change in the genetic material used for vegetable crops has occurred all over the world. Traditional landraces, locally selected over many years, have given way to commercial varieties and hybrids which can give higher and more uniform yields and often carry resistance to diseases. However, in several regions of Italy as well as other parts of Southern Europe, the heterogeneity of the land, the climate and the soil favour the survival in cultivation of a large number of varieties and landraces specifically adapted to local conditions. Thanks to European and national institutions promoting sustainable use of agricultural resources, the farmers' awareness and willingness to both grow and preserve this germplasm and to commercially prize their production have increased.

Most of the Italian sweet pepper (*Capsicum annuum* L.) varieties and landraces have an extremely limited geographic distribution and show adaptation to local pedo-climatic conditions, however, as they are often identified with vernacular names, very similar genotypes might be differently named in different areas. In order to preserve this germplasm at risk of genetic erosion an accurate assessment of the amount and distribution of its genetic variation is needed.

Here we report on the application of amplified fragment length polymorphism (AFLP) markers to assess genetic variation among Italian sweet pepper (*Capsicum annuum* L.) accessions representative of the germplasm at present in cultivation. Genetic similarities among accessions were calculated according to Jaccard's Similarity Index and used to construct a dendrogram based on the unweighted pair group method using arithmetic averages (UPGMA). Our results show that the AFLP technique, which can simultaneously assay a large number of loci randomly distributed in the genome, is much more informative on the genetic relationship and origin of accessions than the limited number of morphological characters conventionally used for variety discrimination. Furthermore, our results contribute in identifying efficient strategies to manage the genetic resources of Italian sweet pepper as well as in identifying suitable material for future breeding efforts.

Genetic resources of eggplant (*Solanum melongena* L.) and their utilization in India

Mathura Rai, Major Singh and Sanjeet Kumar

Indian Institute of vegetable Research, 1, Gandhinagar, P. B. # 5002, Varanasi-221 005, India. Email: pdveg@up.nic.in

The *Solanum* spp. originated in Asia and Africa. China is considered as secondary center of diversity. The most important species, *S. melongena* (eggplant), was domesticated in the Indo-Burman region and spread all over the world. Realizing the importance of plant genetic resources of *Solanum* spp., a total of 2531 accessions of cultivated and wild species have been augmented from different parts of India and southern Asian countries under IPGIRI and NBPGR (ICAR) collaborative programme. Characterization and evaluation of these germplasm have also been done and lines for specific horticultural traits have been identified. In India, the diversity was collected from Indo-Gangetic Plains, Western Region, North Western Deacon plateau, northern hills and plains, North eastern region, Chhatisgarh region, Vidharbha and tribal belt of Central India. The maximum diversity and distribution of *Solanum* species was observed in southern India Indo-Gangatic plains, foot-hills of Himalayas and North Eastern Region. The wild species distributed species in different regions of India includes: *S. torvum*, *S. indicum*, *S. insanum*, *S. surattense*, *S. pubescens* and *S. khasianum*.

At NBPGR, New Delhi, 2419 accessions of cultivated and wild species were evaluated and characterized for a set of 44 horticultural characters. A rich variability was recorded for plant height (40.3-96.5 cm), number of primary branches per plant (4.6-10.3), days to 75 % flowering after transplanting (23-82), days to horticultural maturity (55-87), flowers per cluster (2.2-9.30), fruit length (4.3-36.7 cm), fruit circumference (6.5-46.3 cm), fruit weight (35-725 g) and the clusters per plant (8.4-35.5). Systematic evaluation of germplasm was also undertaken at several other places in India including IARI and IIVR. At Indian Institute of Vegetable Research (IIVR), Varanasi, 48 cultivated and wild accessions have been characterized using RAPD markers.

Selection and hybridization followed by selection have been the two most widely adopted methods for eggplant improvement in India. Nevertheless heterosis breeding and breeding for transgenic resistant to shoot and fruit borer has been accomplished in the recent past. The work on wide hybridization has also been conducted, but with very limited success. Considerable numbers of improved pure lines and hybrids with specific fruit size and shape have been developed. Among these, 39 pure lines, 6 resistant varieties against bacterial wilt and 21 hybrid varieties have been recommended for cultivation through All India Co-ordinated research Project. The achievements and thrust areas of genetic improvement of eggplant in India will be highlighted.

***Solanum melongena* (Eggplant) - A possible interspecific origin**

V. Rattan Kumar, Y.V. Rao and B.G.S. Rao

Department of Botany, Andhra University, Visakhapatnam - 530 003, India
e-mail: rattanvk@yahoo.co.in

In an attempt to resolve the enigmatic problem concerning the origin of *Solanum melongena* L (Egg plant) the earlier inferences drawn were that *Solanum indicum* L., a highly polymorphic form (Santapu 1948) and *Solanum surattense* Burm F, were the putative parents. F₁ interspecific hybrid between *S. indicum* and *S. surattense* were obtained that yielded fruits which resembled those of some cultivars of *S. melongena*. Intraspecific variations were discernible in different 'populations' of *S. surattense* and *S. indicum* obtained from different geographical regions of India and only specific genotype of the two species are cross compatible and in such cases, these F₁ hybrids simulate the Egg plant.

The three species *S. indicum*, *S. surattense* and *S. melongena* with the 'populations' and cultivars have had a common origin. At the same time, *S. indicum* and *S. surattense* in their wild forms have diverged in their own evolutionary pathways, while retaining their identity as distinct species and highly variable in their genetic architecture - $\frac{3}{4}$ in the sense that different populations respond differently to the different cultivars of *S. melongena* as tested through interspecific crosses in different combinations. In evolutionary terms there has been some amount of divergence in *S. indicum* and *S. surattense*, but each of which have converged to preserve their identity interms of adaptational and therefore, survival values as these occur in different environs.

It is therefore postulated that the nearest and immediate progenitor of the egg plant are particular populations of *S. indicum* and *S. surattense* though harmonious genomic blend of which the earliest *S. melongena* was derived and this through directed selection by man, has reached its present evolutionary status as an extremely divergent species among the non-tuberiferous armed (Spinous) *Solanaceae*.

Germplasm collection eggplant and pepper genetic resources in Armenia

K.M. Sarikyan

Scientific Center of Vegetable and Industrial Crop. Daracert, Ararat Region, Masis Subregion, 378322, Armenia. Email: karuine_sarikyan@mail.ru

The Scientific Center of Vegetable and Industrial crops (SCVIC) has been actively retrieving germplasm of eggplant and pepper species from 1998. Over 224 accessions of eggplant and 177 accessions of pepper have been collected since 2000-2003. Some of the Armenian eggplant and pepper collection have a specific richness, for instance primitive and wild species eggplant, pepper, local and world wild collection, selection bio multiplicity, landraces and cultivars. The collection including breeding and research material *Solanum*, *Capsicum* genus, belonging the rest of accessions to *S. melongena*, *S. aethiopicum*, *S. dulcamara*, *S. nigrum*, *S. integrifolium*, *S. sisymbreifolium*, *S. macrocarpon*, *S. ovigerum*, *S. citeullofolium*, *C. annuum* var. *grossuum*, *C. annuum* var. *longum*, *C. eximium*, *C. pendulum* Willd, *C. baccatum*, *C. pubescens*, *C. frutescens*, *C. chinense*. Armenian landraces *Solanum melongena* and *Capsicum annuum* collecting in the Ararat, Armavir, Tavush, Vajoc Dzor regions.

Eggplant old local varieties and form such as a of **Yerevani Tegakan** and **Haykakan Yerkar** very old local population Armenia, and grown for many centuries. The population of **Local Hot pepper**, **Tegakan kcu**, **Cicak**, **Bibar** old local Armenian cultivars which have been know since the 19th century.

The genus *Solanum* includes local cultivars and landraces eggplant samplis of *S. melongena* subsp. *occidentale* (var. *falcatum* Haz, var. *Yerevanski* Haz, var. *eueopaeam* Fil, var. *bulgaricum* Fil, var. *kashgaticus* Fil, var. *romosisimum* Haz, var. *ismir* Haz), *S. melongena* subsp. *orientalis* Fil (var. *depressum* Bailey, var. *serpentinum* Bailey, var. *pekinense* Fil), *S. melongena* subsp. *meridionale* (var. *esculantum* Bailey, var. *americanus* Fil, var. *palestinicum* Fil, subsp. *subspontaneum* Fil (var. *leucoum* Alef, var. *arabicum* Fil).

The genus *Capsicum* includes local cultivars and landraces sweet pepper samplis of *C. annuum* subsp. *grossum* (var. *ovatum*, var. *cordatum*, var. *latum*, var. *zylindricum*, var. *pomifera*), and local cultivars and landraces hot pepper samplis of *C. annuum* subsp. *longum* (var. *brevi-bactylus*, var. *longum*, var. *conooides*, var. *proboscideum*, var. *ornomrntal*, var. *acuminatum*, var. *dactylus*, var. *cerasiforme*).

All accessions of the eggplant and pepper collections have been characterized and evaluated for many morphological, biological and agronomic traits at different ecological/geographical zones of Armenia.

In view of the basis trends of plant breeding, screening of accessions has been made in order identify genetic sources and donors of valuable traits. The most important characters were disease and pest resistance, earliness, quality of products, special breeding tagets for eggplant and pepper. Many accessions in the eggplant and pepper germplasm collections, utilization of the breeding programmes.

Current state of the collection of pepper (*Capsicum annuum L.*) in Gene Bank Olomouc, RICP Prague

Helena Stavěliková

Research Institute of Crop Production (RICP) Prague, Vegetable Gene Bank Olomouc, Šlechtitelů 11, 783 71 Olomouc, Czech Republic., E mail: Stavelikova@genobanka.cz

The genetic resources of pepper (*Capsicum annuum L.*) are maintained in Gene – bank in Olomouc. The Gene – bank in Olomouc forms a part of the Czech national gene – bank for agricultural crops.

The collection of pepper consists of 508 accessions. The main part of this collection presents the old open pollinated varieties from Hungary 131 acc., Soviet Union 60 acc., Czechoslovakia 52 acc., USA 49 acc., Bulgaria 45 acc. and Czech Republic 15 acc.. New accessions are obtained from the seed companies.

From 2000 to 2003 the pepper has been grown in isolation cages. From 1995 to 1999 the pepper was grown in a plastic greenhouse. The plants were isolated by special bags to avoid cross pollination. After removal of the bags the fruits sets were labelled by the cotton. We took seeds only from labelled fruits. The harvested seeds are stored at –20° C. Now 95% of collection is regenerated. 90% of accessions are available for the distribution (depending on the multiplication state).

The evaluation of pepper includes 31 characters: plant – stem pubescence, height, habitus, leaf – pubescence, length, inflorescence – number of flowers per axil, flower position, corolla colour, corolla spot colour, anther colour, filament colour, stigma axsertion, calyx margin, calyx annular constriction, fruit – anthocyanin spots or stripes, colour at intermediate stage, position, set, colour at mature stage, shape, length, width, shape at pedicel attachment, neck at base of fruit, shape at blossom end, cross-sectional corrugation, surface, seed – colour, 1000-seed weight, fruit dry matter content, ascorbic acid content and capsaicin content.

For evaluation we use Descriptor for pepper (IPGRI 1997).

IPGRI, AVRDC and CATIE. 1995. Descriptors for *Capsicum* (*Capsicum* spp.). International.

Plant Genetic Resources Institute, Rome, Italy; the Asian Vegetable Research and Development Center, Taipei, Taiwan, and the Centro Agronomico Tropical de Investigacion y Esenanza, Turrialba, Costa Rica.

The CGN *Capsicum* (Pepper) and non-tuber bearing *Solanum* (eggplant) collections

Willem van Dooijeweert and Ietje Boukema

Centre for Genetic Resources The Netherlands (CGN), P.O. Box 16, 6700 AA Wageningen, The Netherlands, Contact: www.cgn.wur.nl

The Centre for Genetic Resources, the Netherlands holds the mandate to conserve and promote the utilisation of plant and animal genetic resources in the Netherlands. It maintains 23.000 accessions of 20 horticultural and agricultural crops.

The *Capsicum* and non-tuber bearing *Solanum* collections originate from the former Institute for Horticultural Plant Breeding (IVT). These collections were working collections used for breeding work. CGN adopted these collections in 1992. The collections include old cultivars received from Dutch and foreign seed firms and genebanks, but also wild species.

The collections were rationalised by rejecting duplicates and hybrids. Missing passport data such as population type, origin data and the taxonomic nomenclature were revised in 2003.

The *Capsicum* collection holds 951 accessions and the non-tuber bearing *Solanum* collection 389 accessions. Material not meeting the CGN quality and quantity standards was regenerated. Dutch breeding firms assisted in these regenerations. About 95 % of the collection is safety duplicated at the Genetic Resources Unit of HRI Wellesbourne, United Kingdom.

The collection of non-tuber bearing *Solanum* includes unique material from Syria and Africa, collected during the eighties by the former IBPGR (now IPGRI) and given in trust to the IVT.

Most of the accessions have been characterised for morphological characters. Evaluation data of screenings for disease resistances are partly available (TMV in *Capsicum*, *Verticillium* and *Fusarium* in eggplant). Part of the *Capsicum* collection has been screened with AFLP, ISSR and RAPD markers in order to screen genetic diversity. Most of the characterisation and evaluation data are searchable from the CGN website. All material is freely available on request under a Material Transfer Agreement.

Studies on electrophoresis on interspecific hybrids of eggplant

Warade S. D., Sanap P.B., Patil R.S., Bhalekar M.N. and Gupta N.S.

¹ Professor, Department of Horticulture, Mahatma Phule Krishi Vidyapeeth, Rahuri 413 722 (M.S.) INDIA Email : sudhakarwarade@yahoo.co.in ². Department of Horticulture, MPKV, Rahuri. ³. Professor, Department of Horticulture, Mahatma Phule Krishi Vidyapeeth, Rahuri 413 722 (M.S) INDIA. Email : rajhort@indiatimes.com ⁴. Tomato Improvement Scheme, Department of Horticulture, MPKV, Rahuri ⁵. Research Associate, Deptt of Hort. MPKV, Rahuri Email : nitinsgupta@indiatimes.com

The present investigation was carried out to study interspecific hybrids in eggplant. The interspecific hybridization programme was undertaken with two eggplant cultivars (viz Ruchira and Phule Harit) and four wild species (Viz *S. indicum* , *S. insanum*, *S. integrifolium* and *S. gilo*). The hybridity of interspecific hybrids was confirmed by total protein analysis (derived from seed proteins) on the basis of hybrid specific bands, intermediate bands, total number of bands and with different band intensities. Further more for confirmation of hybridity the bands obtained in total protein analysis were also used to calculate a similarity index of interspecific hybrids with their parents (0-13.63 % with female parents and 0- 20% with male parents) was observed , which proved hybridity of F₁ plants. All the interspecific hybrids could be distinguished by the unique patterns of protein bands and their intensities.

Morphological evaluation of *Capsicum* germplasm using statistic analysis

Young Chae^{1,2}, J-C Shieh³, J-B Park⁴ and L.M. Engle³

¹ National Horticultural Research Institute, RDA, Suwon 441-440, Korea ² Email: chyoun@rda.go.kr

³ Genetic Resources and Seed Unit, Asian Vegetable Research and Development Center, P.O. Box 42, Shanhua, Tainan 741 Taiwan

⁴ Dept. of Environ. Hort., The University of Seoul, Seoul 130-743, Korea

Pepper is a major spice crop in Korea. Pepper germplasm characterization plays an important role in finding out new genetic resources with desirable traits needed for breeding cultivars and conserving the diversities of pepper germplasm. *Capsicum* germplasm of AVRDC genebank is utilized as useful sources in the breeding of improved pepper cultivars adapted to subtropical and temperate regions. *Capsicum* has mainly distinguished species from floral characters. Morphological characters are very important to classify the *Capsicum* species. The object of this study was to analysis of diversity in *Capsicum* species by using qualitative and quantitative data.

A total of 225 accessions from 8 *Capsicum* species reserved at the Asian Vegetable Research and Development Center were characterized using thirty-seven morphological traits from seedling stage to inflorescence stage.

Canonical discriminant analysis using thirteen quantitative characters produced three kinds of canonical components. Can1, can2, and can3 explain 100% of variation. Corolla and pedicel characters were the most effective than other characters. These characters need to be added to new item for evaluating *Capsicum* germplasm.

Cluster analysis using twelve quantitative characters developed four clusters. Cluster 1 contained only *C. annuum*. Main species of cluster 2 group was *C. annuum* and following was *C. baccatum*. Majority of cluster 3 group were *C. frutescens* and following was *C. chinense*. Cluster 4 group contained *C. pubescens*, *C. chinense* and *C. baccatum*.

Cluster analysis using twenty-eight qualitative characters produced dendrogram of six clusters. Based on coefficient value of 0.53, similarity of 225 accessions can be divided into 6 clusters. Cluster 1 group contains *Capsicum annuum* and can be divided into 4 sub-clusters at similarity coefficient value of 6.0. Cluster 2 contains *C. chacoense*, *C. baccatum*, and *C. frutescens* and can be divided into two sub-clusters at similarity coefficient value of 0.55. Cluster 3 contains *C. chinense*. And *C. pubescens* belongs to cluster 4. A few accessions having purple color of flower in *C. annuum* belongs to cluster 5 and 6 group.

As a result of canonical discriminant analysis and cluster analysis, twenty *Capsicum* accessions misclassified based on passport data were reassigned in the viewpoint of species status based on morphological traits. Seven *Capsicum* accessions were separated into two species within one accession based on morphological traits.

Genetic resources of pepper (*capsicum annum l.*) in Serbia

B. Zecevic, M. Mijatovic, R. Djordjevic and D. Cvikic

Centre for Vegetable Crops, 71 Karadjordjeva St., 11420 Smedrevska Palanka, Serbia

The Solanaceae vegetable species lead in total vegetable production in Yugoslavia. Moreover, pepper is very significant for Serbian market. Due to a long tradition of pepper growing, we have a great natural diversity within the species. The collection of genetic resources of pepper actually started when the serious work on the breeding of these species started (the end of 60's and the beginning of 70's). Crucial part in this job had the Centre for Vegetable Crops. Until the end of 80's, the collection has not been systematically organized and could not be used by other researchers. In order to add a part of the pepper collection of the Centre for Vegetable Crops to the National Gene Bank, the systematization started, but it stopped during the 90's (due to political circumstances). In the meantime, the national collection has not been enlarged and the number of accession has remained the same as at the beginning. On the other hand the collection of pepper in the Centre for Vegetable Crops has been improved in the meantime by enlarging the number of accessions, by systematization, by place and conditions of storing etc.

BREEDING PROGRAMS AND STRATEGIES

Performance of phenotypic selection for a polygenic trait : QTL conservation and loss across the cycles of selection of pepper for resistance to *Phytophthora capsici*

Alain Palloix, Ganaëlle Bernard, Arnaud Thabuis, Anne-Marie Daubèze, Thérèse Phaly, Patrick Signoret, Véronique Lefebvre

I.N.R.A., Génétique et Amélioration des Fruits et Légumes, BP 94, 84143 Montfavet Cedex, France. Contact: alain.palloix@avignon.inra.fr

Abstract: Criollo de Morelos 334 (CM334) is one of the most promising sources of resistance to *Phytophthora capsici* in pepper. This Mexican accession is distantly related to bell pepper and its resistance displays a complex inheritance. The QTLs involved in resistance to *P. capsici* were previously mapped. In order to transfer the resistance factors from CM334 into a bell pepper genetic background, a modified recurrent breeding scheme was initiated. The breeding population was divided into 3 sub-populations which were screened by distinct phenotypic tests of increasing severity. The plants from the first sub-population were screened with low severity test and backcrossed to the susceptible bell pepper, the plants from the second and third sub-populations were screened by more severe resistance tests and intermated with the plants from the first and second sub-populations respectively. In this study, the changes in allelic frequencies at molecular markers linked to the resistance QTLs were analysed during 5 screening/intermating cycles. The results showed that the allelic frequencies of QTL strongly depended on the sub-population and screening severity, the more severe the screening test, the higher the frequency of the resistant alleles at the QTLs in the selected plants. Regarding allelic frequency changes with the selection cycles, a loss of resistant QTL alleles was observed in the first sub-population that was backcrossed to the susceptible parent, particularly for the low effect QTLs. A better conservation of the resistant QTL alleles was observed in the two other sub-populations that were intermated. A parallel trend was observed in the phenotypic data with an increasing resistance level from the first to the third sub-population. The changes in the allelic frequencies of neutral loci and in horticultural traits across the breeding process indicated that the recovery of the recipient parent genome was not significantly affected by the selection for resistance.

Keywords: breeding method, polygenic trait, quantitative trait locus, genetic resistance, *Capsicum annuum*, *Phytophthora* root rot.

Introduction

Several sources of resistance to the soilborne Oomycete *Phytophthora capsici* Leon. were reported in pepper. All the resistant accessions were pungent and small fruited genotypes and exhibited a partial (quantitative) resistance with polygenic inheritance (Palloix et al 1990). QTL analysis of the resistance from different accessions confirmed the polygenic inheritance (Thabuis et al 2003), particularly in the Mexican pepper accession *Criollo de Morelos 334* (CM334) which showed a high resistance level controlled by the combined effects of 6 significant QTLs.

Breeding large fruited cultivars for resistance requires to transfer resistant alleles at several loci from the donor (small fruited) parent and to recover the elite genetic background from the recipient (large fruited) parent. This was experienced through backcrossing, but a significant decrease of the resistance level in the advanced backcross progenies was observed, probably due to the loss of some resistance factors over the backcrossing cycles. Thus, a new breeding scheme was proposed (Palloix 1992) as an attempt to transfer the resistance alleles into the elite genetic background while retaining the useful resistance factors in the breeding population (fig.1). This breeding scheme was performed on a genetic narrow-based population (Morelos population) including CM334

as the resistant donor parent and Yolo Wonder (YW) as the recipient parent. As the population was biallelic at all the marker loci, this material was suitable for the molecular analysis of the efficiency of this breeding scheme.

The present work presents the *a posteriori* analysis of this breeding scheme by taking into account phenotypic data from selection and molecular genotyping analyses of the population. The objectives of our study were (i) to validate the resistance QTLs previously mapped, (ii) to evaluate the allelic frequency changes of the population with respect to the resistance QTLs and the genetic background and (iii) to check whether both the objectives of the scheme were fulfilled *i.e.* improving resistance and maintaining horticultural traits.

Material and methods

The breeding population

Crosses between YW as the recipient *Phytophthora*-susceptible bell pepper line and the resistant donor line CM334 delivered 3 sub-populations (figure 1). L1 was the susceptible BC1 progeny (designated BC1s), L2 was the resistant BC1 progeny (designated BC1r) and L3 was obtained by selfing the resistant L2 plants. L1, L2 and L3 were submitted to screening tests differing in severity using a moderately aggressive *P. capsici* strain in L1, a highly aggressive strain in L2, the same strain but under high temperature (32°C) in L3. In each sub-population, 300 to 500 plants were submitted to disease screening with a selection intensity from 3 to 5% (15 selected plants). Those plants from L1 were backcrossed to YW, those from L2 and L3 were crossed to the plants from L1 and L2 respectively, using pollen mixtures, so that 15 half-sib families were obtained in each sub-population. Six cycles of selection were performed (C1 to C6). During those 6 cycles, plants were not screened for horticultural traits.

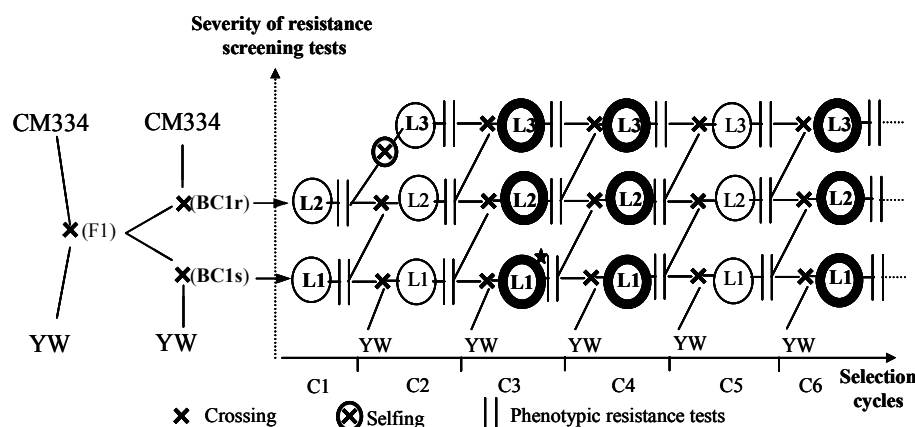

Figure 1. Schematic presentation of the Morelos population breeding scheme

The reciprocal backcrosses at the origin of the population are indicated on the left. The horizontal axis represents the cycles of selection. Each sub-population at each cycle is represented by the circles. At every cycle, the L1 sub-population is backcrossed by the susceptible line (YW) and the L2 and L3 sub-populations are crossed by L1 and L2 (pollen mixtures) respectively. The bold circles indicate the sub-populations and cycles that were sampled for molecular genotyping and from which doubled haploid lines were produced for horticultural traits evaluation. The vertical axis represents the severity of resistance screening tests applied to the sub-populations.

Resistance screening tests and horticultural trait evaluation

The *P. capsici* strains S101 (moderately aggressive) and S197 (highly aggressive) were maintained as described in Clerjeau et al. (1976). Plants were artificially inoculated as described by Pochard and Daubèze (1980). Susceptibility of individual plants was measured with the speed of stem necrosis (REC, IND and STA components) and was expressed as a % of the parental lines (100 for the susceptible parent YW, 0 for the resistant parent CM334).

Evaluation of the horticultural traits was performed only at cycles 3, 4 and 6. At those cycles 40 to 60 homozygous lines were derived from each subpopulation L1, L2 and L3. For each DH line, the mean fruit weight (FW), the first axis length (AL) and mean internode length (IL) were measured in a field trial (3 randomized blocks of 3 plants).

Molecular essays

For molecular genotyping analyses, 50 plants were sampled from the L1, L2 and L3 subpopulations at cycles C3, C4 and C6 (450 plants analysed). 36 markers were used, including 34 AFLP loci and 2 PCR-based markers. Those markers were chosen on the basis of the QTL mapping results from Thabuis et al (2003). Six resistance QTLs were tagged using 14 markers located in their confidence intervals defined as (LODmax-1) interval. Three markers were located outside the confidence intervals of the resistance QTLs and 19 additional markers mapped on 5 chromosomes without previously mapped resistance QTLs (i.e. non-carrier chromosomes).

Data analysis

In order to analyse the effect of selection on the phenotypic values (resistance and horticultural traits), the data were submitted to the ANOVA model : $P_{ijkl} = \mu + C_i + L_j(C_i) + F_k(L_j, C_i) + R_{ijkl}$ where μ is the mean of the data, C_i the 'cycle' factor, $L_j(C_i)$ the 'sub-population' factor (within the cycle), $F_k(L_j, C_i)$ the 'family' factor (within the cycle and the sub-population) and R_{ijkl} the residual effect.

For QTL validation, the 36 markers were analysed on the 450 plants and a QTL analysis was performed using a single factor ANOVA. A QTL was declared significant if $P < 5 \cdot 10^{-3}$.

For comparing the observed values of horticultural traits and of allelic frequencies to the expected values, the theoretical allelic frequencies of the sub-populations (in the absence of selection) were calculated, assuming that the frequency of an allele in a progeny is the mean of the parental allelic frequencies : if $F_{i,j}$ is the frequency of Yolo Wonder alleles in the sub-population 'i' at the selection cycle 'j': $F_{i,j} = (F_{i,j-1} + F_{i-1,j-1})/2$.

Results and discussion

Validation of the resistance QTLs

Five of the 6 QTLs previously reported by Thabuis et al. (2003) as involved in resistance using a F2 mapping population were significantly involved in *P. capsici* resistance in the breeding population. Only QTL Phyto 5.1 was not detected again. The percentage of phenotypic variation explained by the markers was smaller and the QTL positions were slightly different. The reduced set of markers, the unbalanced allelic frequencies in the breeding population and the use of ANOVA weaken the QTL detection and position and affected the distinction between the two linked QTLs Phyto.5.1 and 5.2 which were probably redetected as a single one (De Koeyer et al 2001). Another major reason explaining these differences was the occurrence of genetic recombination between markers and QTL during the cycles of phenotypic selection that did probably not drag all the markers.

Efficiency of selection for resistance

Comparing the sub-populations for their phenotypic resistance levels displayed significant differences ($p=10^{-4}$), with an increased resistance level from L1 to L2 and from L2 to L3 (fig. 2). The molecular genotype analyses confirmed this trend, with a significant increase of the frequencies of the CM334 alleles at all the QTLs from L1 to L3 (fig. 3). In L1, very low frequencies at some QTL markers indicated that some resistant alleles were not selected in this sub-population. This indicated that the increase in severity of the screening tests resulted in the selection of increased sets of resistant alleles, since the selection intensities were not strongly different among the sub-populations.

Considering the change during the selection cycles, the sub-population means varied with weak amplitude, so that the resistance levels remained globally constant within the sub-populations over the selection cycles (fig. 2). CM334 allelic frequencies generally decreased with selection cycles at most of the QTL linked markers except for Phyto.5.2 and Phyto.12.1 in L2 and L3 (fig. 3). Depending on sub-populations and QTLs, this frequency decrease was slow, suggesting the conservation of the QTLs at the heterozygous state in most of the selected plants, or this decrease was steep, indicating the probable loss of some resistant QTL alleles with selection cycles, particularly in L1. This confirms that phenotypic selection preferably retained the genes or QTLs with major effect (Phyto 5.2 and 6.1) and higher heritability. In L3, all the alleles were retained either heterozygous or homozygous (frequency > 0.5). The successful selection of the whole QTL allele set in the population and the allele accumulation observed in the L3 sub-population validated the subdivision into sub-populations and the crossing method. This breeding scheme overcame the loss of resistance alleles during backcrossing and the use of unrealistically large populations when large numbers of alleles have to be transferred into a new genetic background.

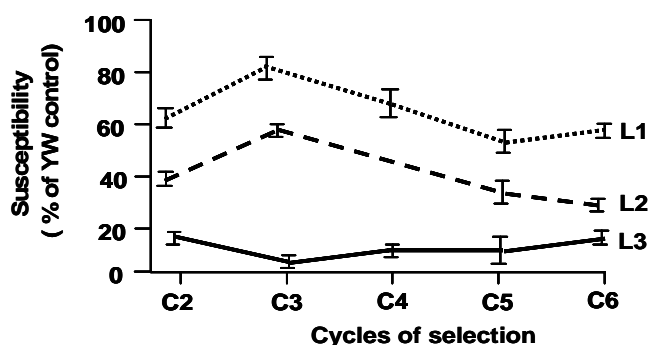

Figure 2: Resistance phenotype of the sub-populations across the selection cycles. Average susceptibility (STA) are expressed as a % of the parental lines with 0 for the resistant parent (CM334) and 100 the susceptible parent (YW). Vertical bars : standard deviation.

Efficiency of the return to the recipient parent

During the breeding process, the Morelos population was screened for resistance but not for horticultural performance. According to the ANOVA results, both the sub-population and selection cycle factors significantly affected the horticultural traits FW, AL and IL (data not shown). The means for the 3 horticultural traits in L1 were closer to the recipient parent values than the means in L2 and in L3. For L1, L2 and L3 analysed independently, the FW means significantly progressed with the selection cycles towards the recipient parent (Tab.1), particularly in L1 where the IL and FW values reached that of YW in C4 or C6. The data obtained from molecular markers showed that allelic frequencies in non-carrier chromosomes fitted closely the theoretical data in the absence of selection (Tab. 1). Observed allelic frequencies were not significantly different from

theoretical ones (at $\alpha=5\%$). In L3, slight deviations were observed at C6 where both molecular and phenotypic data showed lower values than expected (significant at $\alpha=10\%$), suggesting a slight slowing down of the recovery of the recipient parent genome when screening for a very high resistance level.

This indicated that selection for *P. capsici* resistance had no significant or very weak impact on the recovery of horticultural traits, and on the recovery of the recipient genome in non-carrier chromosomes. Mapping data from another population showed that fruit traits mapped in different chromosomes (Ben Chaim et al. 2001), that may explain the absence of significant and unfavourable linkage drag.

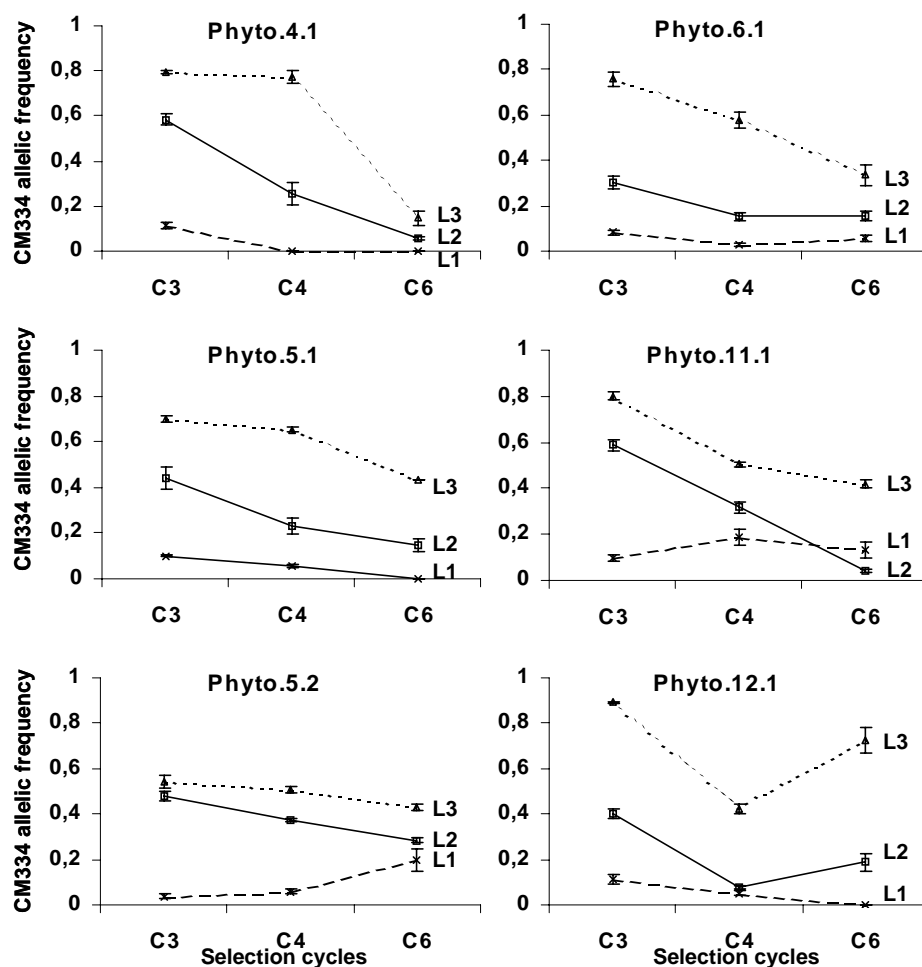

Figure 4: Changes in CM334 allelic frequencies for the markers of the six resistance QTLs.

Vertical bars : standard deviation.

Conclusion

On a practical basis, the breeding scheme presented is flexible as the recipient genetic background can be changed for introducing new characters by changing the recipient line for L1. Considering cultivar release, short-term and long-term achievements are managed together : rapid genetic gain for horticultural traits can promote release of partially resistant cultivars from L1, while highly resistant and improved cultivars can be further selected from the other sub-populations. The molecular and phenotypic evaluation of the breeding scheme showed that most of the objectives were achieved, but also suggested some improvements of the strategy. Based on the QTL mapping data and QTL validation

in the breeding populations, markers are presently being used in the breeding process to transfer the resistant alleles (foreground selection) and accelerate the recovery of the recipient parent genome (background selection) (V. Lefebvre et al, this issue, Hospital and Charcosset 1997). The experimental results will allow future comparison of the performance of phenotypic and MAS breeding methods.

Table 1 : Average allelic frequencies from the recipient parent Yolo Wonder (YW) in the three sub-populations L1, L2 and L3 across the selection cycles C3 to C6.

Expected %: theoretical YW allelic % computed from the crossing plan (Materials & methods). *YW allele %*: observed frequency of Yolo Wonder alleles based on molecular data for the QTL non-carrier chromosomes. *YW Fruit Weight %*: estimation of return to Yolo Wonder phenotype, based on fruit weight data. *nd* : not determined. \pm : standard deviation.

		C 3	C 4	C 6
L3	Expected %	37.50	53.12	78.12
	YW allele %	34.8 (± 8.1)	43.0 (± 7.54)	71.8 (± 5.31)
	YW Fruit weight %	nd	62.7 (± 9.2)	71.5 (± 7.3)
L2	Expected %	68.75	81.25	93.75
	YW allele %	69.2 (± 5.6)	86.5 (± 3.7)	94.1 (± 2.4)
	YW Fruit weight %	73.2 (± 6.2)	79.8 (± 9.1)	92.8 (± 4.1)
L1	Expected %	93.75	96.87	99.22
	YW allele %	91.3 (± 2.9)	94.4 (± 2.37)	98.0 (± 2.1)
	YW Fruit weight %	94.9 (± 3.3)	nd	100.3 (± 2.8)

Acknowledgements

The authors thank the seed companies Clause-Tezier, Gautier Seminis, Syngenta, and Vilmorin for participating to the breeding process.

References

- Ben Chaim AB, Paran I, Grube RC, Jahn M, van Wijk R, Peleman J 2001: QTL mapping of fruit-related traits in pepper (*Capsicum annuum*). Theor Appl Genet 102:1016-1028.
- Clerjeau M, Pitrat M, Nourisseau JG 1976 : La résistance du piment (*Capsicum annuum*) à *Phytophthora capsici*. IV . Etude de l'agressivité de divers isolats au niveau des feuilles, des tiges et du collet des plantes résistantes et sensibles. Ann Phytopathol 8:411-423.
- Hospital F, Charcosset A 1997: Marker-assisted introgression of quantitative trait loci. Genetics 147:1469-1485.
- Pochard E, Daubèze AM 1980 : Recherche et évaluation des composantes d'une résistance polygénique: la résistance du piment à *Phytophthora capsici*. Ann Amélior Plant 26:377-398.

- Palloix A 1992: Pepper diseases and perspectives for genetic control. EUCARPIA - 8. Meeting on Genetics and Breeding of Capsicum and Eggplant. Rome 1992/09/7-10. Capsicum Newsletter. n^o spécial, 120-126.
- Thabuis A, Palloix A, Pflieger S, Daubèze AM, Caranta C, Lefebvre V 2003: Comparative mapping of *Phytophthora* resistance loci in pepper germplasm: evidence for conserved resistance loci across *Solanaceae* and for a large genetic diversity. Theor Appl Genet 106:1473-1485.
- De Koeber DL, Phillips RL, Stuthman DD 2001: Allelic shifts and quantitative trait loci in a recurrent selection population of oat. Crop Sci 41:228-234.

Results of three cycles of marker-assisted backcross in pepper for resistance QTLs to *Phytophthora capsici*

Véronique Lefebvre¹, Arnaud Thabuis¹, Bertrand Servin², Anne-Marie Daubèze¹, Patrick Signoret¹, Frédéric Hospital², Alain Palloix¹

¹ I.N.R.A., Génétique et Amélioration des Fruits et Légumes, BP94, 84143 Montfavet cedex, France. ² I.N.R.A., UMR de Génétique Végétale, Ferme du Moulon, 91190 Gif sur Yvette, France. Contact: veronique.lefebvre@avignon.inra.fr

Abstract: The aim of the breeding program was i/ to transfer resistance to *Phytophthora capsici* alleles at four QTLs from a small fruited pepper (Perennial) into a bell pepper recipient line (Yolo Wonder) thanks to markers of the QTLs, ii/ to validate the resistance QTLs by re-detecting their effects in the advanced breeding population. The marker-assisted selection program was initiated from a doubled-haploid line issued from the mapping population PY and involved three cycles of marker-assisted backcross (MAB). For QTL validation, two populations derived by selfing the plants selected after the first selection cycle were genotyped and evaluated phenotypically for their resistance level. The additive and epistatic effects of the four resistance factors were re-detected and validated in these populations, indicating that introgression of 4 QTLs in this MAB program was successful. A decrease of the effect for the moderate-effect QTLs and of the epistatic interaction was observed. For the transfer of resistant alleles at the QTLs, the number and position of the markers was optimized taking into account theoretical and practical constraints. The targeted QTLs were efficiently transmitted across the 3 MAB cycles, and the level of resistance was maintained in those progenies. Additional neutral markers were used to screen for genetic background of the recipient parent. In each backcross generation, both the molecular analysis and phenotypic evaluations of horticultural traits indicated a very efficient return to the recipient genotype and phenotype using this MAB strategy, except for the linkage groups carrying the resistant QTL alleles.

Keywords: *Capsicum annuum* L., Disease resistance, *Phytophthora capsici*, Horticultural traits, QTL, Epistasis, Marker-assisted selection

Introduction

Phytophthora capsici, causing root rot and shoot blight, is one of the most devastating diseases of pepper. This soilborne Oomycete causes sudden wilt and the collapse of the plant. Several sources of resistance were described in intraspecific pepper germplasm; all displayed a partial effect and were found in exotic accessions. Perennial is a small-fruited and pungent Indian line displaying a polygenic resistance (Lefebvre and Palloix 1996).

Many pepper breeding programs focused on breeding for resistance to *P. capsici* into large fruited cultivars. However, the released varieties displayed only a weak resistance level.

The advent of molecular markers enabled to identify the QTLs involved in the variation of the *P. capsici* resistance of Perennial, using 114 doubled haploid (DH) lines issued from the cross Perennial x Yolo Wonder (PY). Five QTLs displayed an additive effect on resistance. Four major epistatic relationships were detected between either additive QTLs or between QTLs involved only in epistatic relationships (Lefebvre and Palloix 1996; Thabuis et al. 2003).

Marker-assisted selection appeared as a promising tool for breeding quantitative resistance. Hospital and Charcosset (1997) proposed a two-fold strategy: (i) selection for the donor alleles on the carrier chromosomes (foreground selection) and (ii) in the remaining plants, selection for the return to the recipient parent (background selection). Once the interval lengths and marker locations were defined, they computed the minimal

population size for recovering at least one plant having the entire donor segments for a given type-I-error.

We conducted a MAB program to transfer favourable alleles at the 4 main QTLs controlling resistance to *P. capsici* from Perennial accession into Yolo Wonder, a bell pepper line, by taking into account the optimisations from Hospital and Charcosset (1997). A DH line from the PY mapping population, having the 4 main QTLs (Thabuis et al. 2003), was used as the donor parent to initiate the MAB program. In this paper, we examined (i) the results of 3 MAB cycles conducted according to the theoretical optimisations, (ii) the additive and epistatic effects of the transferred QTLs in validation populations, and (iii) the impact of the background selection step on the improvement of horticultural traits.

Material and methods

Plant material and breeding scheme

DH285, a DH line issued from the PY mapping population, was chosen as the donor parent: it possessed the 4 favourable Perennial alleles to be transferred and a YW genome content of 3.6% on the QTL-carrier chromosomes and 43.8% on the non-carrier chromosomes (Lefebvre et al. 2002). Two of the favourable alleles to be transferred were linked (~20 cM) on the chromosome P5; they were considered as a single segment during the MAB process. The 2 others mapped on P2 and P10. Three MAB cycles were performed with markers linked to the 4 *P. capsici* resistance QTLs, and with markers distributed on whole the genome.

Two validation populations were derived from the backcross populations in order to evaluate accurately the QTL effects in the recipient genetic background. The BC1S1_AE progeny, composed of 620 plants, was derived by selfing one BC1 plant carrying the resistance allele at the 4 QTLs. The BC1S1_AE progeny was genotyped with the QTL markers and was evaluated phenotypically for *P. capsici* resistance level, in order to evaluate QTL additive effects. The BC1S1_EE progeny, composed of 620 plants, was derived by selfing two BC1 plants carrying both resistance QTLs on P5 and P10 displaying an epistatic interaction and the most efficient return to the recipient parent. The BC1S1_EE progeny was genotyped with markers of the P5 and P10-QTLs, and assessed for *P. capsici* resistance level, for evaluating the epistatic relationship between QTLs. In addition, the resistance level of the selfed progeny of the selected BC2 plants (BC2S1) was assessed to evaluate the performance of the MAB strategy.

Trait evaluation

The moderately aggressive *P. capsici* strain S101, used for phenotypic assays, was maintained as described by Clerjeau et al. (1976). *P. capsici* resistance was evaluated using the stem inoculation test described by Pochard and Daubèze (1980), that supplies three quantitative resistance components (REC: receptivity, IND: inducibility and STA: stability). The lower the value of the resistance component, the higher the resistance level.

The horticultural traits were evaluated on 50 sampled plants from each backcross generation (BC), in 2 locations (greenhouse in Spain, field in Italy) during two years for BC1 and BC2 and a single year for BC3, in a complete randomised design of 5 blocks of 10 plants. The horticultural traits evaluated were the length of the main axis (AL in cm, from cotyledon to the 1st flower), the number of leaves (NL) on this axis, the internode length (IL=AL/NL), the average fruit weight per plant (AFW in g), the fruit length (FL in mm), the fruit width (FW in mm), the fruit flesh thickness (FT in mm) and the fruit shape (FS=FL/FW).

Molecular data

The DNA was extracted thanks to the microprep protocol described by Fulton et al. (1995). A total of 10 markers were used for the foreground selection step (with 3 to 4 markers for controlling each QTL interval). Sixteen AFLP primer combinations were used for the background selection. The BC1S1_AE population was genotyped with 11 markers that mapped in the confidence interval of the 4 QTLs transferred. The BC1S1_EE population was genotyped with 3 markers that were linked to both QTLs displaying epistatic interactions.

Data analyses

The molecular data from the MAB program were used for selecting plants carrying the donor alleles at the 4 QTLs and displaying the best return to the recipient parent. The return to the recipient parent was accurately estimated using the MDM software which computes the probability of the donor allele presence in each point of the genome (Servin et al. 2002).

The additive QTLs were validated in BC1S1_AE by using the Interval Mapping (IM) method with the QTL Cartographer software (Basten et al. 1997), on the analysed markers that were mapped using the Mapmaker software (Lander et al. 1987). The digenic interaction effect between markers on P5 and on P10 was tested using a 2-way ANOVA in the BC1S1_EE population.

A one-way ANOVA was performed on the resistance components assessed on the BC1S1_AE and BC2S1 populations to explore the progress for the resistance value during the MAB cycles.

Analysis of the horticultural traits showed a strong location effect (15% to 55% of the total variation according to the trait) and a year effect (5% of the total variation). Significant interactions between backcross population and location and between backcross population and year also occurred. Consequently, the 4 trials were analysed independently. An effect was declared significant if $P < 0.05$.

Results and discussion

Optimisation of the MAB strategy

The markers used during the MAB program were roughly located in the QTL confidence intervals. They were chosen so that they maximised the probability of recovering the donor favourable alleles at the 4 target QTLs based on the computations of Hospital and Charcosset (1997). While the minimal population size based on the computations of Hospital and Charcosset (1997) was 280 plants for a type-I-error of 1%, we genotyped 350 plants for each MAB cycle to enhance the probability of transferring the favourable alleles at the QTLs and to apply a significant selection pressure for the background selection step.

Increasing the population size drastically increased the genotyping effort. However, we adopted a sequential approach in order to minimise the genotyping effort (Table 1). In a first step, only one marker per QTL was checked. One PCR-based marker linked to the QTLs on P5 was firstly assayed. Only the plants carrying the Perennial allele at this marker were further evaluated with one PCR-based marker of the P10-QTL. Then, the plants harbouring the Perennial allele at the P5 and P10 QTL-markers were screened with one PCR-based marker of the P2-QTL. In a second step, AFLP and RFLP markers were assayed on the reduced-size progeny in order to check for the integrity of the transferred QTL intervals. This sequential approach decreased the genotyping effort from 3500 data points (10 markers x 350 plants) to 772-844 data points depending on the selection cycle. Five to eight plants possessed the Perennial allele at the markers of the 3 target genome segments, depending on the selection cycle, enabling a background selection rate of 1/5 to 1/8. In a third step, these plants were screened with AFLP markers regularly spread on the

genome. Return to the recipient parent on the non-carrier chromosomes was very efficient as the recurrent genome content increased from 43.76% in the donor line DH285 to 97.66% in the selected BC₃ plant (Table 2). After only 3 MAB cycles, all the non-carrier chromosomes were converted to the recipient genome. The return to YW genome on the carrier-chromosomes was limited to the extremity of the chromosomes P5 and P10, and more important on the chromosome P2. The few plants retained from the foreground selection step did not permit to accelerate the return to YW on the QTL-carrier chromosomes. To achieve this objective, a population size up to 600 or 800 individuals would be necessary according to Hospital and Charcosset's simulations (1997). After the third step, a single plant was selected and backcrossed to YW.

Table 1: Number of plants selected at each step of the sequential approach

Initial number of plants	Foreground selection				Background selection	
	Step 1			Step 2	Step 3	
	One PCR-based marker of P5-QTL	One PCR-based marker of P10-QTL	One PCR-based marker of P2-QTL	7 markers for the integrity of the confidence interval of the P5, P10 and P2 QTLs	Markers of 16 AFLP primer combinations on non QTL-carrier chromosomes	
BC ₁	350	173	73	34	5	1
BC ₂	350	148	71	29	6	1
BC ₃	350	164	78	36	8	1

Table 2: Percentage of the Yolo Wonder parent based on molecular data

	QTL-Carrier chromosomes	Non QTL-carrier chromosomes
DH285	3.69%	43.76%
The plant BC ₁ (3)	14.53%	67.98%
The plant BC ₂ (3)	21.58%	90.45%
The plant BC ₃ (3)	25.55%	97.66%

Validation of the 3 transferred segments and of the epistatic relationship

The QTL detection in BC₁S₁_AE population using Interval Mapping demonstrated that the 3 transferred segments displayed an effect on the resistance components. A single QTL on P5 was re-detected in the BC₁S₁_AE population; it displayed the most important effect on the 3 resistance components as observed in the PY mapping population (Thabuis et al. 2003). The transferred alleles at the QTL on P5 mostly displayed an additive expression for the 3 resistance components. The QTLs on P2 and P10 displayed both a moderate effect on REC although their R² values were lower than in the PY mapping population. The large size of the validation population and the change of genetic background towards YW increased the accuracy of the QTL effect and location estimation compared to the PY mapping population, and consequently revealed the true breeding value of the QTLs.

The epistatic effect due to the digenic interaction between the QTLs on P5 and on P10 was validated in the BC₁S₁_EE population (P=0.0195, R²=9.44%, for REC, and P=0.0347, R²=9.40%, for STA) but the R² was lower than in the PY mapping population. The Perennial homozygous genotypes at both QTLs significantly displayed the most resistant values.

Genetic advance for the resistance components and for the horticultural traits

Evaluation of the 3 resistance components to *P. capsici* showed that the BC1S1_AE and BC2S1 populations were significantly more resistant than YW as a result of the transfer of the resistance QTLs. The BC1S1_AE population means were not significantly different from DH285 means while the BC2S1 population were significantly less resistant than DH285. The BC2S1 population was less resistant than the BC1S1_AE population for IND and STA, while the means were not significantly different at 1% for REC.

For each trial and for all the horticultural traits, the MAB cycle effect was always found highly significant (13% to 50% of the total variation depending on the trait) whereas the block effect and the interaction between MAB cycle and block was rarely significant or explained less than 1% of the total variation. The genetic advances for 8 horticultural traits evaluated were estimated for each trial. They were all significant and in good agreement across the locations and the years. The strongest improvement was observed for AFW (average fruit weight) and FS (fruit shape). Comparing the horticultural advance between the 3 MAB cycles, the improvement toward the large fruited genotype was continuous. The AFW and FT (fruit flesh thickness) increased significantly, reaching respectively 70 to 73% and 86 to 100% of the recipient parent. These values illustrate the phenotypic impact of the marker-assisted selection for the genetic background. The slowest genetic advance observed for AFW could in part be explained by the co-location observed between the transferred resistance QTL on P10 and a QTL involved in fruit weight (Ben Chaim et al. 2001). The FS and IL (internode length) decreased more progressively but also reached the values of the recipient parent. As expected, the genetic advance observed in BC2 was generally larger than that observed in BC3.

Acknowledgements

This work and A. Thabuis were financially supported by ‘Vilmorin, Clause and Cie’ and ‘Seminis Vegetable Seed’. The authors thank deeply the breeders C. Basterreix, J.W. Hennart and C. Robledo for their help in the program management. The authors also thank A. Blattes, V. de Conto, M. Havard and M. Moreau for their valuable help in the genotyping work, and T. Phaly, G. Nemouchi and D. Potey for the progeny production and experimental trials.

References

- Basten CJ, Weir BS, Zeng ZB. 1997: QTL cartographer: a reference manual and tutorial for QTL mapping. Dept of Statistics, North Carolina state University, Raleigh, NC, USA.
- Ben Chaim A, Paran I, Grube RC, Jahn M, van Wijk R, Peleman J. 2001: QTL mapping of fruit-related traits in pepper. *Theor Appl Genet* 102: 1016-1028.
- Clerjeau M, Pitrat M, Nourisseau JG. 1976: La résistance du piment (*Capsicum annuum*) à *Phytophthora capsici*. IV. Etude de l’agressivité de divers isolats au niveau des feuilles, des tiges et du collet des plantes résistantes et sensibles. *Ann Phytopathol* 8: 411-423.
- Fulton TM, Chunwongse J, Tanksley SD. 1995: Microprep protocol for extraction of DNA of tomato and other herbaceous plants. *Plant Mol Biol Report* 13(3): 207-209.
- Hospital F, Charcosset A. 1997: Marker-assisted introgression of quantitative trait loci. *Genetics* 147: 1469-1485.

- Lander E, Green P, Abrahamson J, Barlow A, Daley M, Lincoln S, Newburg L. 1987: Mapmaker: an interactive package for constructing primary genetic linkage maps of experimental and natural populations. *Genomics* 1: 174-181.
- Lefebvre V, Palloix A. 1996: Both epistatic and additive effects of QTLs are involved in polygenic induced resistance to disease: a case study, the interaction pepper-*Phytophthora capsici* Leonian. *Theor Appl Genet* 93: 503-511.
- Lefebvre V, Pflieger S, Thabuis A, Caranta C, Blattes A, Chauvet JC, Daubèze AM, Palloix A. 2002: Towards the saturation of the pepper linkage map by alignment of three intraspecific maps including known-function genes. *Genome* 45: 839-854.
- Pochard E, Daubèze AM. 1980: Recherche et évaluation des composantes d'une résistance polygénique : la résistance du piment à *Phytophthora capsici*. *Ann Amélior Plant* 26: 377-398.
- Pochard E, Clerjeau M, Pitrat M. 1976: La résistance du piment, *Capsicum annuum* L., à *Phytophthora capsici* Leon. I. Mise en évidence d'une induction progressive de la résistance. *Ann Amélior Plant* 26: 35-50.
- Servin B, Dillman C, Decoux G, Hospital F. 2002: MDM: a program to compute fully informative genotype frequencies from complex breeding schemes. *J. Hered* 93(3): 227-228.
- Thabuis A, Palloix A, Pflieger S, Daubèze AM, Caranta C, Lefebvre V. 2003: Comparative mapping of *Phytophthora* resistance loci in pepper germplasm: evidence for conserved resistance loci across Solanaceae and for a large genetic diversity. *Theor Appl Genet* 106: 1473-1485.

Studies on interspecific hybridization in eggplant (*Solanum melongena* L.) for little leaf disease resistance

S.D. Warade, P.B. Sanap, D.M. Sawant and N.S. Gupta

Mahatma Phule Krishi Vidyapeeth, Rahuri 413 722, (Maharashtra) India

Abstract: An interspecific hybridization programme was undertaken with eggplant cultivars viz Ruchira and Phule Harit and four wild species viz *S.indicum*, *S.insanum*, *S. integrifolium* and *S.gilo*. Out of 16 crosses attempted 10 interspecific hybrids were evaluated for little leaf incidence and also for jassid infestation under natural field condition from 30-120 day after transplanting. It was observed that four wild types and ten interspecific hybrid were free from any incidence of little leaf while in cultivated cultivars the disease incidence was recorded within the range of 20- 25 %. Furthermore lower infestation of jassids (.67- 2.00 nymphs/ Leaf) was observed in interspecific hybrids similar to their wild parents (1-2 nymphs / leaf) while considerable jassid infestation (6 nymphs/leaf) was observed in both the cultivated types.

Introduction

Brinjal (*Solanum melongena* L.) is an important commercial vegetable crop, largely grown through out the year in all parts of India except on higher altitudes. Though brinjal is widely grown in India, the cultivable types are prone to infest due to many diseases. Little leaf is the most serious disease among all the diseases throughout India. It was first reported in India in 1939 by Thomas and Krishnaswamy. Earlier, this disease was supposed to be due to virus but has been recently shown to be associated with mycoplasma (Varma *et al.*, 1969). Now, it is said due phytoplasma. The main symptom on brinjal is the reduction of leaf size, the new leaves progressively becomes smaller and sterile.

The disease is not sap transmissible. It is transmitted by jassids. *Hishimonous phycitis* (*Eutettix phycitis*) (Thomas and Krishaswami, 1939). Though chemical and mechanical control measures are useful to reduce the little leaf disease up to some extent it is difficult to control this severe disease completely. The wild species of *Solanum* like (i) *S. indicum*, (ii) *S. insanum*, (iii) *S. integrifolium*, (iv) *S. gilo* and other species have shown high degree of resistance besides immune reaction to several diseases and pest (Kale *et al.*, 1986), however, these genes appear to have limited use in resistance breeding because of the difficulties in the interspecific hybridization. The work carried out on interspecific hybridization in brinjal is rather limited. Therefore, the present investigation was undertaken with the objective to study interspecific hybrids and their respective parents for little leaf disease resistance.

Material and methods

The present investigation “Studies on interspecific hybridization in brinjal (*S. melongena*) for little leaf disease resistance” was conducted at Department of Horticulture, Mahatma Phule Krishi Vidyapeeth, Rahuri (M.S.) India. Two genotypes of cultivable species of brinjal (*S. melongena*) viz., Ruchira and JB-16 (Phule Harit) and four wild species viz., *S. indicum*, *S. insanum*, *S. integrifolium* and *S. gilo* were used in the crossing programme.

In order to get F₁ seed of interspecific hybrids, the crosses of two cultivable and four wild types were used reciprocally. Ten F₁ hybrids along with their wild and cultivated

parents were screened under natural field conditions during *kharif*, 2001. Ten plants of each genotype were planted in plot with susceptible border rows (i.e. with cv. Ruchira). The disease and pest incidence was evaluated without spraying any fungicides and insecticides. The observations were recorded at 30, 60, 90 and 120 DAT crop stages.

Results and discussion

It is observed from the table 1, that both cultivated species cv. JB-16 (Phule Harit) and Ruchira were found susceptible to little leaf disease. Devi *et al.* (1995) observed resistance in 8 brinjal varieties to phytoplasma little leaf.

In Ruchira (20±1) incidence at 90 and 120 days after transplanting and JB-16 (Phule Harit) (20±1 and 25±1%) incidence at 90 and 120 DAT to little leaf disease was observed. However, the wild species utilized in the crossing programme, viz., *S. indicum*, *S. insanum*, *S. integrifolium* and *S. gilo* were found resistance (0%) to little leaf disease at 30, 60, 90 and 120 DAT. And all the F₁ hybrids produced from wild species and cultivated species crossed reciprocally were also found resistance (0% incidence) to the little leaf disease. Chakrabarty and Chaudhury (1975) studied the breeding brinjal resistance to little leaf disease. The wild species *S. integrifolium* and *S. gilo* showed a hypersensitive response to the pathogen. F₁ progenies of these wild species with the susceptible cv. PPL behaved like their resistant parent in disease reaction.

Anjaneyulu and Ramkrishnan (1968) reported that wild species of brinjal *S. incanum* and *S. sysimbrifolium* were found resistant to little leaf disease while *S. varium* was found immune. Chakrabarty and Chaudhary (1974) reported that the wild species *S. varium*, *S. indicum* and *S. sysimbrifolium* were observed resistant to little leaf disease.

In the present investigation, all the interspecific hybrids were found resistant to little leaf. Therefore, it could be concluded that the little leaf disease resistance of various wild species of *Solanum* can be incorporated to the cultivated species through interspecific hybridization.

Screening F₁ hybrids and their parents for incidence of jassids

Jassid is one of the major vectors for transmission of little leaf disease (phytoplasma). The leaf hopper, *Orosius albicinctus* Distant is a vector of phytoplasma diseases of many crop and weed plant in India (Suryanarayana and Muniyappa, 1991). The vector was originally reported as *Deltocephalus* sp. and subsequently the same was identified as *O. albicinctus* Distant (Ghauri, 1966). Hence, F₁ interspecific hybrids and their parents were screened for jassid infestation and discussed as below (Table 2).

The maximum infestation of jassids was found in cultivated species viz., cv. Ruchira and JB-16 (Phule Harit). In cv. Ruchira infestation was (3.67±1.15, 5±1 and 6±1 nymphs per leaf) observed at 60, 90 and 120 DAT, respectively. While, in cv. JB-16 the infestation (1.67±1.53, 3.67±0.57 and 6±1 nymphs per leaf) were observed at 60, 90 and 120 DAT. Jarande *et al.* (1994) recorded 3.56, 4.67 and 5.53 nymphs/leaf at 30, 45 and 60 DAT respectively on cv. Manjari Gota. However, in both cultivars the infestation at 60 and 90 days was variable, but at 120 DAT the infestation was found similar.

In the wild species viz., *S. indicum*, *S. insanum*, *S. integrifolium* and *S. gilo* the infestation was very less than the cultivated types. In *S. indicum* (0.67±0.58 and 1±1 nymphs per leaf). *S. insanum* (1±1 and 2±1 nymphs per leaf) and in *S. integrifolium* (0.67±0.58 and 2±1 nymphs per leaf) were observed at 90 and 120 DAT. And in *S. gilo* only 1±1 nymphs per leaf infestation was observed at 90 and 120 DAT. F₁ hybrid *S. insanum* x Ruchira was found resistant (2±1 nymphs nymphs per leaf) at 120 DAT than both the parents. While in reciprocal cross the infestation (1.33±0.58 nymphs per leaf) was observed and found resistant than female parent cv. Ruchira.

The F₁ hybrid *S. integrifolium* x Ruchira was found resistant (1.33±0.58 and 2±1 nymphs per leaf) at 90 and 120 DAT than male parent Ruchira and found nearly similar to female parent *S. integrifolium*. While in the reciprocal cross very less incidence (1±0 and 1.33±0.58 nymphs per leaf) was found at 90 and 120 DAT and was very less than female parent Ruchira. Thus, the resistance was incorporated by the wild parent *S. integrifolium*.

The F₁ hybrid *S. integrifolium* x JB-16 found resistance (1±1 nymphs per leaf and 1.67±0.56 nymphs per leaf) at 90 and 120 DAT than male parent JB-16. While in the reciprocal cross, infestation was 2±1 nymphs per leaf at 90 and 120 DAT was observed and was less than female parent JB-16 (Phule Harit).

The F₁ hybrid *S. gilo* x Ruchira and *S. gilo* x JB-16 (Phule Harit) were found resistant (0.67±0.58 and 1±1 nymphs per leaf) at 90 and 120 DAT respectively than the cultivated Ruchira and JB-16 (Phule Harit).

The F₁ hybrid JB-16 x *S. indicum* was found very resistant (0.33±0.58 and 0.67±1.15 nymphs per leaf) at 90 and 120 DAT than female parent JB-16. Thus, the resistance was totally dominated by the wild male parent *S. indicum*.

From the results, it is indicated that the jassid infestation was found maximum at 60, 90 and 120 DAT in cultivated parents than F₁ hybrids at 90 and 120 DAT. The infestation was very less in wild parents. Thus, the resistance in the F₁ was incorporated from wild parents. The infestation in F₁ hybrids was intermediate between wild species and cultivated types. These results are in conformity with the results reported earlier (Jarande *et al.*, 1994).

From the overall results, it can be concluded that all the four species are resistant sources against the little leaf disease and resistance can be incorporated into cultivated brinjal species through interspecific hybridization.

Summary and conclusion

The results indicated that the interspecific hybrids between the cultivable and wild types and their reciprocals showed resistance to little leaf disease in brinjal. The resistance incorporated in the cultivated types can be confirmed and screened in segregating generation to develop little leaf disease resistant cultivar in brinjal with consumer preference, which can be also used for further crossing programme for development of hybrids.

References

- Anjaneyulu, A. and Ramkrishnan. (1968). Reaction of *Solanum* species to little leaf of Brinjal. Madras Agril. J. 55:142-143.
- Chakrabarti, A. K. and Choudhury, B. (1975). Breeding brinjal resistant to little leaf disease. Proc. of the Indian Nat. Sci. Acad.-B. 41(4):379-385.
- Chakrabarti, A. K. and B. Chaudhary. (1974). Effect of little leaf disease on metabolic changes in susceptible cultivar and resistant allied species of brinjal. Veg. Sci. :12-17.
- Devi, S. N.; Mathew, S. K. and Vahab, M. A. 1995. Evaluation of brinjal for resistance to little leaf disease. South Indian Hort. 43:2-4, 120-121.
- Ghauri, M. S. K. (1966). Revision of the genus, *Orosius* Distant (Homoptera : Cicadellidae). Bulletin of the British Museum (Natural History) Entomology. 8:231-252.

- Jarande, N. T. (1994). Evaluation of imidacloprid against sucking pest infesting chilli and brinjal. M. Sc. (Agri.) thesis submitted to Mahatma Phule Krishi Vidyapeeth, Rahuri (M.S.).
- Kale, P. B.; Mankar, S. W.; Wangikar, P. D. and Gonge, V. S. (1986). Chemical composition of little leaf disease affected leaves of different genotypes of brinjal. Veg. Sci. 13:199-204.
- Suryanarayana, V. and Muniyappa, V. (1991). Sunnhemp phyllody disease in Karnataka. Fitopatologia Brasileira. 16:63-68.
- Tomas, K. M. and Krishnaswamy, C. S. (1939). 'Little leaf' a transmissible disease of brinjal. Proc. Indian Acad. Sci. B. 10:201-212.
- Verma, A.; Chenulu, V. V.; Raychaudhuri, S. P.; Prakash, N. and Rao, P. S. (1969). Mycoplasma-like bodies in tissue infected with sandal spice and brinjal little leaf. Indian Phytopath. 22:289-291.

Table 1. Brinjal interspecific hybrids and their parents tested for little leaf disease occurrence

Sr. No.	Genotypes	Crop stages (DAT)	Per cent little leaf occurrence
I.	Brinjal (<i>S. melongena</i>) cultivars		
1.	Ruchira	90	20.00±2
		120	20.00±2
2.	JB-16 (Phule Harit)	90	20.00±1
		120	25.00±1
II.	Wild <i>Solanum</i> species		
1.	<i>S. indicum</i>	90	0.0
		120	0.0
2.	<i>S. insanum</i>	90	0.0
		120	0.0
3.	<i>S. integrifolium</i>	90	0.0
		120	0.0
4.	<i>S. gilo</i>	90	0.0
		120	0.0
III.	Interspecific F₁ hybrids		
1.	<i>S. insanum</i> x Ruchira	90	0.0
		120	0.0
2.	<i>S. insanum</i> x JB-16	90	0.0
		120	0.0
3.	<i>S. integrifolium</i> x Ruchira	90	0.0
		120	0.0
4.	<i>S. integrifolium</i> x JB-16	90	0.0
		120	0.0
5.	<i>S. gilo</i> x Ruchira	90	0.0
		120	0.0
6.	<i>S. gilo</i> x JB-16	90	0.0
		120	0.0
7.	JB-16 x <i>S. indicum</i>	90	0.0
		120	0.0
8.	JB-16 x <i>S. integrifolium</i>	90	0.0
		120	0.0
9.	Ruchira x <i>S. insanum</i>	90	0.0
		120	0.0
10.	Ruchira x <i>S. integrifolium</i>	90	0.0
		120	0.0

DAT = Days after transplanting.

No disease symptoms were observed at 30 and 90 DAT.

Table 2. Infestation of jassids in interspecific Brinjal hybrids and their parents (nymphs/leaf)

Sr. No.	Genotypes	Crop stages (DAT)			
		30	60	90	120
1.	<i>S. integrifolium</i>	0.00	0.00	0.67±0.58	2.00±1
2.	S. insanum	0.00	0.00	1.00±1	2.00±1
3.	<i>S. indicum</i>	0.00	0.00	0.67±0.58	1.00±1
4.	S. gilo	0.00	0.00	1.00±1	1.00±1
5.	Ruchira	0.00	3.67±1.15	5.00±1	6.00±1
6.	JB-16	0.00	1.67±1.53	3.67±0.57	6.00±1
7.	<i>S. integrifolium</i> x Ruchira	0.00	0.00	1.33±0.58	2.00±1
8.	<i>S. integrifolium</i> x JB-16	0.00	0.00	1.00±1	1.67±0.58
9.	<i>S. insanum</i> x Ruchira	0.00	0.00	2.00±1	0.00
10.	<i>S. insanum</i> x JB-16	0.00	1.00±1	1.33±0.58	1.67±0.58
11.	<i>S. gilo</i> x Ruchira	0.00	0.00	0.67±0.58	1.00±1
12.	<i>S. gilo</i> x JB-16	0.00	0.00	1.00±1	1.00±1
13.	Ruchira x <i>S. integrifolium</i>	0.00	0.00	1.00±1	1.33±0.58
14.	Ruchira x <i>S. insanum</i>	0.00	0.00	0.00	1.33±0.58
15.	JB-16 x <i>S. integrifolium</i>	0.00	0.00	2.00±1	2.00±1
16.	JB-16 x <i>S. indicum</i>	0.00	0.00	0.33±0.58	0.67±1.15

DAT = Days after transplanting.

Evaluation of Chilli (*capsicum annum l.*) genotypes for variability, path analysis and genetic divergence under high temperature

M.N. Bhalekar¹, S.N. Dutonde², N.S. Gupta³, S.D. Warade¹

¹ *Tomato Improvement Scheme, Department of Horticulture, MPKV, Rahuri 413 722 (M.S.) India.* ² *Email: sv318@rediffmail.com.* ³ *nitinsgupta@indiatimes.com*

⁴ *Professor, Department of Horticulture, Mahatma Phule Krishi Vidyapeeth, Rahuri 413 722 (M.S.) India Email : sudhakarwarade@yahoo.co.in*

A study on genetic variability, heritability, path analysis and genetic divergence was carried out in 40 genotypes of chilli in summer season with mean temperature ranging from 5.61⁰ to 40.74⁰ C. The magnitude of phenotypic coefficient of variation was slightly more than genotypic coefficient of variation for all the characters. The yield of green fruits per hectare showed maximum genotypic and phenotypic coefficient of variation followed by capsaicin content and ascorbic acid content. While maximum heritability was observed for yield of green fruits per plant followed by marketable yield of green fruits per plant fruit length and pollen viability indicating the possibility of larger response to selection.

The correlation studies revealed that the yield of green fruits per plant exhibited significant positive correlation with number of primary branches, pollen viability, fruit set and green fruits per plant and positive correlation with plant height, plant spread, days to 50 per cent flowering, days to 50 per cent fruiting, fruit length and capsaicin content.

The study on path coefficient analysis of yield and its component revealed that the pollen variability, fruit set and number of primary branches were important yield determiners possessing maximum direct influence on yield. Diversity studies revealed substantial differences for all the characters in which accessions were grouped into 7 clusters, Cluster-I being largest comprising of 17 genotypes. The maximum intercluster distances (D = 104.98) was observed between cluster IV and cluster VII.

Intercrossing among the genotypes belonging to clusters II, IV and VII was suggested to develop high yielding varieties at high temperatures with other desirable characters.

A new once-over harvest-type varieties 'Saeng-ryeog no. 211' and 'Saeng-ryeog no. 213' in red pepper (*capsicum annuum* L.)

M.C. Cho^{1,2}, **D.H. Pae**³, **Y.S. Cho**⁴, **Y. Chae**¹, **W.M. Lee**¹, **D.H. Kim**¹, **Y.H. Om**¹, **D.S. Kim**¹, **S.R. Cheong**¹, **I.G. Mok**¹, **J.Y. Yoon**⁵

¹ *National Horticultural Research Institute, RDA, Suwon, 441-440, Korea.* ² *Email: chomc@rda.go.kr.* ³ *Asian Vegetable Research and Development Center, Tainan, Taiwan 741.* ⁴ *National Busan Horticultural Experiment Station, RDA, Busan.* ⁵ *Seminis Korea Co.*

Hot pepper has been the second most important crop after rice in Korea for many years in terms of the cultivated acreage as well as source of farmers income. In average, Koreans consume more than 2.5kg of hot pepper powder annually, which is probably the highest in the world. The main usage of hot pepper in Korea is as spice for kimchi (pickled vegetables) and as condiment for various meal preparations. The hot pepper production in Korea is still labor intensive and it is inevitable to reduce the production cost. The present paper is to report a new pepper variety 'Saeng-ryeog No. 211' and 'Saeng-ryeog No. 213', with which farmers can harvest mature pepper fruits in one time. These varieties also offer possibility of mechanized harvesting practice.

As an attempt to find out a way of reducing the labor cost required for harvesting, a breeding program was initiated to develop varieties, which can be harvested once-over. During 1990 to 1992, germplasm collected were evaluated for once-over harvest type. In 1992, a cross between desirable resources, 'RSS' and 'HDA295' was initiated, followed by subsequent selfing generations 2 times, and again crossed with 'Cayenne Cajun' in 1995. After that there were bulk selection 3 times from 1996 to 1998. From the following years 1999 to 2001, they were selfed and selected individually. The selection in the field was focused on the possibility of one-time harvesting and good fruit quality. The final selected line is 'Saeng-ryeog No. 211'. For breeding of 'Saeng-ryeog No. 213' cross between 'Jalapeno' and an unknown variety was made in 1993, followed by subsequent selfing generations in the pedigree breeding scheme from 1994 to 2001.

Genetic analysis of dry fruit yield, fruit quality and pest resistance in Chilli (*Capsicum annuum* L.)

R.C. Jagadeesha (1), N. Basavaraja (2), Ravi Hunje (3)

1 Sr.Scientist (Plant Breeding), AICRP on MULLaRP,

2.Associate Professor (horticulture)

3.Assstant Professor (Seed Science and Technology)

University of Agricultural Sciences, Dharwad 580005 Karnataka India.

(E.mail: rcjagadeesha@yahoo.com)

The present study was conducted to elucidate the genetic basis and inheritance pattern of dry fruit yield, fruit characters and leaf curl index for thrips and mites. The gene action was estimated using six generation mean analysis, involving six diverse parents from nine different cross combinations. Dry fruit yield had higher magnitude of dominant gene action with duplicate epistasis compare to additive gene effects. Additive X Additive interaction was more predominant than other types. Fruit quality traits Viz; fruit length, fruit width, fruit weight, pericarp weight, ascorbic acid content and capsaicin content were under the control of additive type of gene action. Leaf curl complex caused by thrips and mites is a devastating pest on chilli. Breeding resistance is considered the best strategy. Resistance to thrips and mites was under the control of dominance, additive X additive and additive x dominance gene effects. By considering the differential gene effects it would be possible to develop a multiple resistant variety by following recurrent pedigree selection. By utilizing resistant parents like Jwala, LCA-312, GPC-82, Arkalohit, VN-2 and high fruit quality, commercial, widely adapted local varieties like Byadagi Kaddi and Byadagi dabbi in scheme **A** and **B** by intermating and selfing followed by pedigree to derive a resistant variety with high fruit quality.

Earliness as an important trait of field grown pepper (*Capsicum annuum* L.) in Central and Northern Europe

A. Korzeniewska and K. Niemirowicz-Szczytt

Department of Plant Genetics, Breeding and Biotechnology, Warsaw Agricultural University, Nowoursynowska 166, 02-787 Warszawa, Poland

As a result of two decades of experiments it has become possible to grow sweet pepper in the field in the Polish climatic conditions. The cultivation is more successful when mulching (black foil) is applied and suitable varieties (early, repeatable in yield and concentrated in fruit maturing) are used. During the last 15 years the Department of Plant Genetics, Breeding and Biotechnology has carried out a project on adapting sweet pepper to the Polish field growing conditions. As a result, two hybrid varieties have been registered and three highly productive lines are under investigation.

The aim of the study was to compare our five forms (Roberta F₁, Maja F₁, L200, L201 and L202) with four well-known and commonly cultivated varieties developed by other breeding centers (Stanola F₁, Ożarowska, Kasztelanka F₁ and King Arthur F₁). Three-year comparative experiments took place in 2001-2003. Seedlings were planted on 27-30 May in the field mulched with black foil. The experiments were set in the randomized block design (three replicates, 15 plants per plot, 40 x 70 cm spacing). Fruits were harvested by the end of September. Both general and commercial (including early commercial i.e. by September 5) yield was estimated. In addition, the share of red colored fruits in the commercial yield was determined.

The commercial yield of all the varieties tested was similar (on average 290 kg/100 m²) with the highest values observed for L200 (335 kg/100 m²) and the lowest for King Arthur F₁ (242 kg/100 m²). Early commercial yield of five own varieties was much higher (35% of the commercial yield) than that of the standards (11%). Similarly, the share of red colored fruits in the commercial yield was higher in own varieties (83%) than in the standards (54%).

To conclude, all the varieties and lines tested were characterized by high commercial yield and the lines proved to be as good as hybrids. The forms developed by our Department gave higher than average early commercial yield, which confirms that long-time breeding for earliness had brought about positive effects.

Male sterility research at iivr and a success story with *ms-10* gene in hot pepper (*capsicum annuum* L.)

Sanjeet Kumar, Major Singh and Mathura Rai

Indian Institute of vegetable Research, 1, Gandhinagar, P. B. # 5002, Varanasi-221 005, India. Email: sanjeetk1@sify.com

The male sterility research in hot pepper (*Capsicum annuum* L.) at Indian Institute of Vegetable Research (IIVR) was initiated during 1999 with the introduction of a nuclear male sterile line (MS-12) from Punjab Agricultural University (PAU), India and a pair of cms (CCA-4261) and maintainer (PBC-534) lines from Asian Vegetable Research and Development Centre (AVRDC), Taiwan. The stability of cms line was tested and plants of maintainer line were purified for the stable maintenance of cms line. This line has been utilized to develop two potential hot pepper hybrids (CCH-1 and CCH-2), which are being evaluated at multiplications. Meiotic analyses of cms and maintainer lines revealed that CCA-4261 is a sporogenous cms line, which also shares feature of functional sterility. The results also indicated non-dehiscence of pollen as a major mechanism and irregular meiosis at TII as an additional mechanism that provides support to the former in relation to complete expression of male sterility in CCA-4261. The results pertaining to characterization of inbred lines with respect to presence of fertility restorer (*Rf*) and maintainer (*rf*) genes revealed more frequent existence of *Rf* gene in comparatively small fruited hot pepper lines than that of large fruited sweet pepper lines. The works on validation of *Rf* gene associated RAPD markers and transfer of sterile cytoplasm in more desirable genotypes of hot pepper are under progress.

In India, *ms-10* (originally *mc-509*) gene was introduced during 1980s. This gene was transferred in the background of a multiple resistant genotype of hot pepper (Punjab Lal) and male sterile line termed as MS-12. An intensive training on MS-12 line based hybrid seed production was conducted by the PAU under the guidance of JS Hundal, which has resulted in involvement of approximately 200 farmers of Punjab in hybrid seed production of two F₁s (CH-1, CH-3) utilizing MS-12 line. Both these hybrids have become popular in Punjab and Western U.P. Thus exploitation of *ms-10* gene (induced by Dr. E. Pochard in France during 1970) by the farmers in India could be cited as an example of success of mutation breeding in crop improvement. The MS-12 line was cytomorphologically characterized at IIVR and a more efficient utilization of this line has been advocated and adopted by the farmers. The male sterility research in *Capsicum* at IIVR will be elaborated.

Capsicum: cost effective hybrid seed production

N. Nagy^{1,2}, N.F. Derera¹ and P.J. Sharp¹

¹ *The University of Sydney, Plant Breeding Institute, PMB 11, Camden NSW 2570, Australia* ² *Email: natalia@camden.usyd.edu.au*

Paprika (*Capsicum annuum* L. var. *annuum* covar. *longum*) is a crop where hybrid vigour is not exploited widely as the production of hybrid seed is costly in time and labour, and as a consequence, expensive. It is important to decrease the cost of the hybrid seed. We aim to exploit cross-pollination by native Australian bees, so that male sterile paprika plants can give high hybrid seed production.

Several methods have been examined to generate paprika male sterile lines. Male sterile lines (cytoplasmic and genetic) were collected from around the world. These lines were backcrossed into paprika cultivars. Some of the original male sterile lines were either ornamental or other capsicum types, but not condiment paprika. Gamma irradiation was also initiated on seeds to generate male sterility in *longum* types. We aim to develop a designed system where identification of male sterile plants is easy at the seedling stage. Observations have been made to identify phenotypic markers linked to male sterility through the vegetative as well as the generative phase. The AFLP method is being used to find molecular markers linked to the *ms3* gene that is widely used in our crossing program.

Male sterile plants are propagated with the help of micropropagation or as cuttings. Different explant types are used to propagate male sterile lines *in vitro*. Several media have been tested and where the multiplication rate was the highest, used for propagation. Cutting-derived young plants were made in the greenhouse and then tested under field conditions to compare with seedlings.

Male sterile plants will be planted with a pollen source and pollination will take place by insects, mainly native bees (genera *Trigona*, *Austroplebeia*, *Xylocopa*, and *Amegilla*). These are found across Australia and are known to be good crop pollinators.

At the end of this project a cost benefit study will be carried out to test the economics of hybrid paprika seed production in Australia via this system. This will enable the most efficient method of large-scale hybrid paprika seed production within a reasonable price bracket to be found.

Genetic divergence and development of hybrids in bell pepper

Nandadevi^{1,2} and P. R. Dharmatti¹

¹*Department of Horticulture, UAS, Dharwad*

²*Email: nandadevi_s@indiatimes.com*

The experiment was conducted at Olericulture Unit, University of Agricultural Sciences, Dharwad, Karnataka, India. Twenty-six genotypes were congrugated into seven clusters. The bell peppers were grouped under cluster I while, pungent types were grouped under cluster II. In line x tester mating design, an attempt has been made to predict heterotic hybrids by studying yield performance of F₁'s in relation to the morphometric distance among their parental inbreds. On the basis of genetic divergence, maximum heterosis over better parent was observed form cross Arka Gaurav x Tarihal local (395.00%) and Arka Gaurav x 4080-15 (248.15%). This was attributed to moderate genetic distance between the clusters to which the parents of the crosses belong ($D^2=120.19$; $D^2=107.94$, respectively). In general, it was observed that crosses with higher heterosis did not necessarily possess parents with more divergence.

Development of eggplant functional male sterile lines and its utilization

¹Tian Shibing, ¹Wang Yongqing, ²Liu Fuzhong, ¹Luo Zhangyong, ¹Pi Wei, ¹Chen Yikang¹Liu Junshao

¹Chongqing Institute of Agricultural Sciences, Chongqing 400055, China.

Email: twlcp@yahoo.com.cn.

²Vegetable and Flower Institute/CAAS, Beijing 100081, China.

Abstracts: Using functional male sterile material UGA1-MS(introduced from Georgia University, USA) as sterile source, three eggplant functional male sterile breeding lines, F₁₆₋₅₋₈, F₁₃₋₁₋₇ and F₁₂₋₁₋₁, had been successfully developed by means of crossing and backcrossing with eggplant bred lines, and pedigree selection. F₁₆₋₅₋₈, F₁₃₋₁₋₇ and F₁₂₋₁₋₁, having desired and stable agronomic traits and positive combining ability effects, showed high sterility, and the rates of sterile plants were as high as 98.8%, 98.6%, and 98.8% respectively. Three restoring lines, 66-3, D-28, 110-2, having uniform traits and high combining abilities, were also obtained by screening from 410 eggplant accessions, their average restoring abilities were 90.35%, 92.95%, and 91.85% respectively. The cross combinations made between ms lines and restorers showed significantly positive heterosis, indicating high yielding hybrids could be developed by utilizing ms lines and restoring lines. Applying ms lines to hybrid seed production could reduce the costs of hybrid seeds, meanwhile the quality of seeds were also improved.

Key words: Eggplant, Functional male sterile line, Restoring line, Breeding, Utilization.

Combining ability analysis of Eggplant functional male sterile lines and restorers

Tian Shibing, Wang Yongqing, Luo Zhangyong, Pi Wei, Chen Yikang, and Liu Junshao

Chongqing Institute of Agricultural Sciences, Chongqing 400055, China.

Email: twlcp@yahoo.com.cn.

Abstract: The combining abilities and heritability for early yield, total yield and fruit setting were analyzed according to 49 hybrid crosses made between 7 seven eggplant ms-lines and 7 restorers with incomplete diallel mating design. The results showed that three traits were controlled by both additive and non-additive gene actions. More than 50% crosses had positive heterosis, indicating high yielding varieties could be developed through heterosis breeding. Among 7 eggplant ms-lines, F₁₅₋₅₋₈ was a good combiner for three traits, and was a promising male sterile parent, followed by F₁₃₋₁₋₂ and F₁₃₋₁₋₄. Among 7 restorers, only D-28 and 66-3 had better performance and could be applied in heterosis breeding program.

Key words: Eggplant, Male sterile line, Restoring line, Combining ability, Heritability.

Evaluation of Chilli (*Capsicum annum L.*) hybrids for yield and quality characters

Daljeet Singh^{1,2}, J.S. Hundal¹, D.S. Khurana¹, T.S. Dhillon¹, Neena Chawla¹ and Sampuran Kaur¹

¹ Department of vegetable crops, Punjab Agricultural University, Ludhiana 141001 Punjab, India.

² E-mail:- bimal_deep@rediffmail.com

The hot pepper improvement program is in progress in the Deptt. of vegetable crops P.A.U. since 1970. The first CMV, TMV, leaf curl and mosaic complex resistant variety (**Punjab Lal**) was developed and later on genetic male sterile line (**MS-12**) was developed which is also resistant to viruses (CMV & leaf curl). Utilizing this male sterile line **MS-12** two commercial hybrids **CH-1** and **CH-3** were developed which are widely adopted in northern India. The present studies were carried on chilli hybrids developed using **MS-12** as female parent and elite material as male parents. The fifteen new hybrids were evaluated along with the check hybrids **CH-1** and **CH-3**. These hybrid seeds were planted in October 2002 and seedlings were transplanted in Feb 2003. The observations were recorded on yield (Kg/Plant), dry matter (%), Capsaicin (%) and colouring matter (ASTA). The hybrids showing high yield are identified. The selections **Dekki Green**, **S2539-3**, **S2530**, **PS422**, **S2529** and **S2545** when used as male parents found to have good specific combining ability with **MS-12** for yield as compared to genotypes **Pb.Guchedar**, **Punjab Surakh**, **PS12-1**, **ELS-II**, **Pepsi 8-1**, **Selection 46**, **New Vardhan** and **Happer**. The hybrids viz. **MS-12 X PBC830**, **MS-12 X S2528** and **MS-12 X Happer** were identified possessing very high colouring matter viz. 178.4, 180.2 and 205.2 ASTA respectively. The highest capsaicin content was observed in **MS-12 X LSS** hybrid followed by **MS-12 X Punjab Guchedar** and **MS-12 X S2539-3** respectively. The Capsaicin content percentages in these three hybrids ranged from 0.74 – 0.78, however the lowest capsaicin was estimated in hybrid **MS-12 X Sel370**. The hybrid **MS-12 X S2530-1-1** was identified as best hybrid for earliness possessing high dry matter (18.98%), capsaicin (0.62%) and colouring matter 122.0 ASTA. An early male parent Sel370 is identified possessing very low capsaicin (0.30%) and very high colouring matter (191.4 ASTA), which is utilized in heterosis, breeding program to develop hybrid with low pungency and high colouring matter.

Evaluation of elite material of brinjal and their hybrids

J.C. Thakur¹, Daljeet Singh^{1,2}, S.S Bal¹, A.S Sidhu¹, and T.S Dhillon¹

¹ Department of vegetable crops, Punjab Agricultural University, Ludhiana 141001
Punjab, India

² E-mail:- bimal_deep@rediffmail.com

Brinjal improvement program is in the progress in the department of vegetables crops P.A.U. Ludhiana. The present studies were carried out during 2001 rainy season and eight genetically diverse lines viz. **PB-30, PB33, PSB, NDBS 26-1, NDBS 28-2, Punjab Barsati, KS 331 and KS 352** were involved in hybridization program. These eight long fruited brinjal lines were evaluated along with their hybrids for economic characters viz. early yield/ plant (g), yield/ plant (kg), fruit length (cm), fruit diameter (cm) and No. of fruits / plant. The genotype **KS 331** was identified the best for all the traits under study since the early (436g) and total yield (1.25 kg) was highest as compared to check “**Punjab Barsati**”. The hybrids were also evaluated for these economic traits the best hybrids viz. **PB33 X KS 331** (667g early yield / plant and 2.15 kg total yield per plant). ; **PB33 X PSB** (663g early yield / plant and 1.99 kg total yield per plant).; **PB Barsati X NDBS 28-2** (517g early yield / plant and 1.91 kg total yield per plant); and **PB Barsati X KS 331** (497g early yield / plant and 1.89 kg total yield per plant) are identified as the highest early and total yielder / plant out of the twenty eight hybrids tested. The fruit length of the hybrid **PSB X KS 331** was maximum (17.52 cm) followed by **PB –33 X KS 331** (17.01) thus indicating that **KS 331** is the good combiner for yields and fruit length. The fruit no. of the hybrids **PB33 X KS 331** and **PB33 X PSB** were highest (37.1) followed by **PSB X NDBS 28-2** (33.3) significant heterosis was evident from the range of the parents when compared with that of hybrids. The range in parent for total yield was 0.91 to 1.25 kg / plant. Similarly the range in parents for no. of fruits was 13.1 to 23.1 / plant, where as the range in the hybrids for this trait was 12.51 to 37.17 per plant thus indicating that these eight are the potential genotypes to develop hybrid possessing significant heterosis for early and total yield per plant along with fruit number.

The creation of sweet pepper hybrids tolerant to biotic and abiotic stressors and improved biochemical composition of fruits

Timina O.O.¹, Timin O.Y.², Daskalov S.³, Alekseev Y.B.⁴, Ignatova S.I.²

¹ *The State University of Transnistria, the Optics laboratory 128, 25th October Street, Tiraspol, Transnistria, 3300, E-mail otimin@mail.ru.*

² *All Russian Scientific Research Institute of Vegetable Crops, Moscow region, Zhuckowsky, Russia E-mail: otimin@mail.ru.*

³ *The Institute of Genetics, BAN, Sofia, Bulgaria*

⁴ *The Agrofirma Semko-Junior, Building 1/6, Malaya Suchorevskaya Square, Moscow 103051 E-mail: semco@moscow.portal.ru.*

Creation of hybrids with complex tolerance for verticillium wilt and bottom mould, caused by high temperature and irregular water supply, and also the improving of the biochemical content of the fruits is one of the priority trends in the breeding of sweet pepper for Transnistrian and some Russian regions.

The creation of hybrids with high content of β -carotene and vitamin C was carried out on the sterile basis using previously selected lines, tolerant to several biotic and abiotic stressors. The lines were characterized by different period of ripeness, shape and colour of the fruits and content of both vitamins. The best in combination ability were used for hybridization.

As the result some of the early-ripe hybrids have been created. They are characterized by original red – orange colour, the content of β -carotene in raw material reaches 6 – 10 mg/100g, the content of ascorbic acid is not less than the standard. The fruits of new hybrids are notable for high taste advantages, thick walls and are of universal usage: they are suitable for fresh consumption and canning. The best of them after the results of variety - testing control are prepared for State Variety Testing Control of Russian Federation and Transnistria in 2005 in cold plastic green – houses and open ground.

Hungarian pepper varieties grown on rockwool.

D. Tompos¹, J. Gyúróš¹

*¹Budapest University of Economic Sciences and Public Administration
Faculty of Horticultural Sciences, Department of Vegetable- and Mushroom Growing
1118 Budapest, Ménesi út 44, Tel.:0036-1-372-6225, <ratm@freemail.hu>*

In the past decade in Hungary it has become characteristic that ever greater proportions of pepper for fresh consumption comes from glasshouses or plastic tunnels, even in summer months. Therefore due to economical considerations it seems reasonable to extend the forcing season as long as possible. For longer cultivation only those varieties that have indeterminate growth can be considered.

Besides the pepper growing on soil different hydrocultural technologies spread by growers. The technology of growing pepper on rockwool becomes very significant. The reason of this process is, that the ecological factors, first of all nutrition, irrigation, could be kept in a constant level, ideal for plants. Also we isolate our plants from the soils, which are hardly fit or just getting unsuitable for growing plants because of different reasons (nematods, high EC level, ect.).

Production has also been enriched with new technological elements: it has become necessary to ensure the precise regulation of the vegetative-generative equilibrium of the varieties. Pruning is an important means for it.

In the spring of 2003 a new trial was arranged at the Experimental Station of the Faculty of Horticultural Sciences of BUESPA.

The trial investigated the influence of two factors, pruning method and plant density, on yield and crop quality. Three different pruning technologies were applied to three varieties. In the first treatment plants were pruned to a single stem, in the second they were trained to two, in the third to three stems. Depending on the degree of pruning plants were planted at different spacing distances in four replications. The aim was again to find out if the pruning method or the spacing had any influence on the performance of the different varieties, common in Hungary as well. The varieties involved in the trial: HÓ F₁, HRF F₁, and DANUBIA F₁ representing the triangular fruit shape type.

From the three observed varieties the HÓ F₁ reached the highest level in our given conditions. Considering all the indicators observed, it has been concluded that in early forcing, due to economical reasons, the single, and the two stem method is recommended. The HRF F₁ was a bit lower in results. Basically, the single- and the two stem technology seems to be reasonable. The variety DANUBIA F₁ finished with lower yield, than the other two varieties. In case of DANUBIA F₁ the two stem method is recommended.

Earliness and high yield cultivar model breeding in hot pepper (*Capsicum annuum* L)

Deyuan Wang^{1,2}, and Ming Wang³

¹*Vegetable Institute, Guangdong Academy of Agricultural Sciences, Guangzhou 510640, PRC.* ² *Email: wdy168@163.net.* ³*College of Horticulture, Northwest Agri-forest Sci-Tech University, Shaanxi 712100, PRC.*

According to ecological conditions, cultivation technique and germplasm status at Guanzhong region in Shaanxi province, system science was applied in hot pepper breeding field. Choosing 5 parents and 10 F₁ obtained from half-diallel cross between these parents as experimental materials, the cultivar model with the characteristics of earliness (800-1200Kg/667m²) and high yield (4000-4500Kg/667m²) was optimized. The results showed that the agronomic characters of this cultivar model was as followed: plant height 54.9-59.5 cm, plant spread 38.9-43.1 cm, number of second branches/plant 2-2.8, node of first flower 7.8-8.8, days to flowering 102.9-106.5, fruit weight 28.7-48.7 g, number of early fruits/plant 2.6-4.9, number of total fruits/plant 17.2-29.6.

Verticillium wilt resistance and cytoplasmic male sterility in progenies of eggplant rootstock variety, 'Taiby VF'

T. Yoshida^{1,2}, H. Matsunaga^{1,3}, T. Saito¹, T. Yamada^{1,4} and A. Saito¹

¹ National Institute of Vegetable and Tea Science, 360 Kusawa, Ano, Age, Mie 514-2392, Japan. ² Headquarters of National Agriculture and Bio-oriented Research Organization, 3-1-1 Kannondai, Tsukuba, Ibaraki 305-8517, Japan. ³ National Agricultural Research Center for Tohoku Region, 4 Akahira, Shimo-kuriyagawa, Morioka, Iwate 020-0198, Japan. ⁴ Email: yamatomo@affrc.go.jp

Abstract: Verticillium wilt is one of the most serious diseases affecting eggplant cultivation in Japan. However, no variety resistant to Verticillium wilt has been bred yet. Related species or interspecific hybrids between related species and cultivated species are applied as the rootstocks. 'Taiby VF', Japanese rootstock variety is an interspecific hybrid between *Solanum grandifolium* and *S. melongena*, resistant to Verticillium wilt and sterile in general. We are trying to introduce the genes resistant to Verticillium wilt from *S. grandifolium* to *S. melongena*. Although 'Taiby VF' was very difficult to set seeds, 'Taiby VF' x 'LS1934 (*S. melongena*)' produced a few seeds. The progeny of 'Taiby VF' x 'LS1934' were evaluated resistance to Verticillium wilt and male sterility.

Many progeny expressed the male sterility and/or the malformation of leaves and stems. Verticillium wilt resistance of the progeny of 'Taiby VF' x 'LS1934' was weaker than that of 'Taiby VF'. Since the lines obtained by backcrossing *S. melongena* to the male sterility lines entirely expressed the male sterility, it was considered that this character was the cytoplasmic male sterility caused by the cytoplasm of *S. grandifolium*.

The cytoplasmic male sterility in this study is stable, and the progeny lines obtained by backcrossing *S. melongena* don't express the malformation of leaves and stems at all.

New rootstock ‘Eggplant Ano 2’ with highly resistance to bacterial wilt and fusarium wilt

T. Yoshida^{1,2}, S. Monma^{1,3}, H. Matsunaga^{1,4}, Y. Sakata¹, T. Sato¹, T. Saito¹, A. Saito^{1,5} and T. Yamada¹

¹ National Institute of Vegetable and Tea Science, 360 Kusawa, Ano, Mie, 514-2392

Japan. ² Headquarters of National Agriculture and Bio-oriented Research Organization.

³ National Agricultural Research Center for Kyushu Okinawa Region. ⁴ National Agricultural Research Center for Tohoku Region.

⁵E-mail: ashin@ffrc.go.jp

‘Eggplant Ano 2’ is a Bacterial wilt- (*Ralstonia solanacearum*) and Fusarium wilt- (*Fusarium oxysporum*) resistant rootstock eggplant.

Grafting by using rootstocks resistant to Bacterial wilt, Fusarium wilt and Verticillium wilt is a common practice in areas where these diseases occur in Japan. Rootstock cultivars of eggplant-related species, ‘Torvum vigour’ and ‘Torelo’ (*Solanum torvum*) and ‘Karehen’ (*S. sanitwangsei*) are commonly used as resistant rootstocks in Japan. The purpose of this breeding program was to develop a Bacterial wilt- and Fusarium wilt-resistant eggplant suitable for grafting.

‘Eggplant Ano 2’ resulted from the cross of ‘Nantou Nasu’ and ‘LS1934’. ‘LS1934’ was used as the pollen parent because it showed a high resistance to Bacterial wilt and Fusarium wilt. ‘Nantou Nasu’ also showed a high resistance to Bacterial wilt and was used as the seed parent.

‘Eggplant Ano 2’ is highly resistant to Bacterial wilt and Fusarium wilt. The early growth of its seedlings is superior to that of the eggplant-related species rootstocks. The total yield of the Japanese common cultivar ‘Senryo 2’ grafted on ‘Eggplant Ano 2’ is higher than that of the cultivar grafted on ‘Torvum vigor’.

The fruit of ‘Eggplant Ano 2’ is round shape, dark purple in color, and has a pattern in the lower part. ‘Eggplant Ano 2’ is tall with a thick stem, green in color and has large leaves.

‘Eggplant Ano 2’ is suitable for summer culture in areas infected with Bacterial wilt.

PHYSIOLOGY AND QUALITY

Genetics of pungency from phenotype to genotype and back to phenotype

A. Ben-Chaim^{1,2}, M. Falise¹, Y. Borovsky³, M. Mazourek¹, C. Stewart¹, M. Taranto¹, K. Liu¹, M. Kreitinger¹, I. Paran³ and M. Jahn¹

¹ Department of Plant Breeding, Cornell University, Ithaca NY, 14853. ² Email: ab357@cornell.edu. ³ Agricultural Research Organization, Volcani Center, POB 6, Bet-Dagan, 50250 Israel.

For many years, the genetic basis of pungency in pepper was regarded as highly complex, dependent on genotype, environment and other interactions that were difficult to characterize. We decided to tackle this trait using an integrated approach focused on qualitative and quantitative sources of genetic, biochemical and chemical variability. We will describe these studies focusing on results from genetic studies of qualitative traits that affect pungency, on QTL analyses, candidate genes and biochemistry. We will report the current status of a large molecular linkage map built in an F₂-F₃ *C. frutescens* x *C. annuum* population that contains about 400 SSR markers anchored by RFLP markers. F₃ families from this population were screened in three different environments for total pungency level and three capsaicin analogs. Heterosis was exhibited for capsaicinoid derivatives and in some of the environments transgressive segregation was also apparent. One trait, dihydrocapsaicin, had a bimodal distribution in both environments in the F₃ generation, suggesting involvement of a major partially dominant gene. The genetic correlations between capsaicin analogs in all environments were positive and high, suggesting the involvement of common genes. Twenty QTL in total were identified for pungency; 15 were observed in all environments and 11 were located on 3 chromosomes (3, 4, and 7). We have obtained candidate genes for these QTL from three major sources, the structural genes of the capsaicin biosynthesis pathway, a cDNA library we developed from mature pepper (*C. chinense*) fruit subtracted with leaf mRNA (SSH library), and previously published work. Out of 14 structural genes mapped in this population, two seem to be strongly associated with QTL of pungency level, and two others remain to be confirmed. From the SSH library, one gene, presently unique to pepper with a motif of valine catabolism in its sequence appeared to be associated with QTL on chromosome 3. We have also pursued study of the placental blisters and their relationship to capsaicin biosynthesis. We have also begun to systematically examine the genus for the presence and composition of capsaicin analogs, identifying genotypes and species with pronounced and characteristic differences in capsaicin analog composition. We will describe progress in these studies and implications for the management of this important trait in pepper.

Search for low temperature tolerant *Capsicum* accessions to conserve energy in greenhouse pepper production

Erik A.M. de Swart, Leo F.M. Marcelis, Roeland E. Voorrips

Plant Research International, P.O. box 16, 6700 AA Wageningen, The Netherlands.

Contact: roeland.voorrips@wur.nl, Tel +31.317.477289

Abstract: In this study the effects of lowering the air temperature on growth of a broad range of (partially wild) *Capsicum* accessions was analysed by means of a growth analysis. During the first 49 days, the increase of dry mass in time, expressed as relative growth rate, differed 19 % between the best and worst growing *Capsicum* accession under standard temperatures. Under lowered temperatures, the difference in growth rate was 28%. Large differences in growth rate were found between plants of the same accession grown under standard and lowered temperatures. A cold adapted accession of *C. pubescens* showed the smallest decrease whereas Red Top, the accession with the lowest final dry mass under standard temperatures, showed the largest decrease (41%). This shows that considerable variation for low temperature tolerance is present in *Capsicum*.

The difference in growth rate under standard and lowered temperatures was not correlated with growth rate at standard temperatures, but significantly correlated ($R^2=0.62$) with growth rate under lowered temperatures. This indicated that in order to select for genotypes that are less influenced by temperature differences it is necessary to select under sub-optimal temperature conditions. Finally it was found that plants that grow under lowered temperatures were able to adapt to these conditions by increasing their light use efficiency.

Keywords: *Capsicum*, growth, growth related traits, low temperature tolerance, genetic resources

Introduction

Sweet pepper (*Capsicum annuum*) has become the leading greenhouse crop in the Netherlands. The energy input necessary to grow sweet pepper is very high (annual use of natural gas is 40-50 m³ gas m⁻²). In order to reduce the energy input during pepper growth, more information is needed on the influence of energy on growth. Growing pepper plants at a lower temperature is one of the options to reduce energy consumption. In order to grow pepper plants at lower temperatures, we need cultivars that are better adapted to these temperatures.

Grime & Hunt (1975) found that species originating from unfavourable conditions tend to have an inherently low Relative Growth Rate (RGR: increase in dry mass per unit biomass present per unit of time) under non-limiting conditions, whereas plants naturally occurring in favourable environments have an inherently high RGR. They suggested that these low growth rates under unfavourable conditions could be an adaptation to conditions of stress. Atkin *et al.* (1996) showed for example that alpine *Poa* species (adapted to low temperatures) had a lower RGR compared to lowland *Poa* species under optimal conditions. In a study of 16 contrasting plant species deriving from different habitats, Loveys *et al.* (2002) found that the optimal growth temperature can vary between species. In *Capsicum* relatively little is known about the influence of temperature on growth in a broad range of species and accessions. Studies in *Capsicum* often focus on commercially grown accessions (Nilwik, 1981; Si *et al.*, 1996) and to variation in night temperatures (Bhatt & Srinivasa Rao, 1993; Tarchoun *et al.*, 2000). In this study the effects of lowering the air temperatures on growth of a broad range of (partially wild) *Capsicum* accessions was analysed by means of a growth analysis.

Materials and Methods

Plant material

Eleven *Capsicum* accessions from different habitats were studied. Table 2 shows the accessions used, the country from which they originate and additional information why they were chosen to be tested. Bruinsma Wonder, Jatilaba and their F₁ were selected as standards, for comparison with earlier experiments. Other accessions were chosen based on average day temperature in their natural habitat in comparison to standard Dutch glasshouse conditions. Red top and PI 159233 were chosen because of their known growth characteristics in earlier experiments.

Table 1. List of *Capsicum* accessions studied, origin and additional information

Species	Origin	Additional information
1 <i>C. annuum</i> cv Bruinsma Wonder ¹⁾	Netherlands	Dutch sweet pepper variety
2 <i>C. annuum</i> cv Jatilaba²⁾	Indonesia	Hot pepper
3 <i>C. annuum</i> (PI 585238) ³⁾	Equador	Lower temperatures in natural habitat
4 <i>C. pubescens</i> (PI 585265) ³⁾	Equador	Lower temperatures in natural habitat
5 <i>C. chinense</i> (PI 543184) ³⁾	Bolivia	Higher temperatures in natural habitat
6 <i>C. baccatum</i> (PI 585248) ³⁾	Equador	Lower temperatures in natural habitat
7 <i>C. baccatum</i> (PI 585241) ³⁾	Equador	Lower temperatures in natural habitat
8 <i>C. annuum</i> x <i>C. annuum</i> F ₁ (Jatilaba x Bruinsma Wonder)		
9 <i>C. annuum</i> x <i>C. annuum</i> F ₁ (PI 585238 x Bruinsma Wonder)		
10 <i>C. annuum</i> cv Red Top ¹⁾		Poor growth in earlier experiments
11 <i>C. chinense</i> (PI 159233) ¹⁾	USA	Good growth in earlier experiments

¹⁾ Seeds were obtained from the CGN (Wageningen, The Netherlands)

²⁾ Seeds were obtained from the RIV (Lembang, Indonesia)

³⁾ Seeds were obtained from The National Germplasm System, USA.

Plant cultivation

Plants were grown in a glasshouse at Wageningen (The Netherlands, latitude 52 °N) from September 2003 to January 2004. Seeds were germinated at a day temperature of 21 °C (16 hours) and a night temperature of 19 °C (8 hours). At 14 days after sowing (d.a.s.), seedlings were transplanted to rock wool cubes and from that time on irrigated with nutrient solution.

The temperature treatment started at 14 d.a.s. Plants were distributed over four compartments of which two had an actual average day/night temperature of 21.1/18.7 °C (standard temperature) and two had an average day/night temperature of 17.3/14.7 °C (lowered temperature). Relative humidity varied between 66 and 69%. Artificial HPI-T light (ranging from 20 to 30 $\mu\text{mol m}^{-2} \text{s}^{-1}$ photosynthetically active radiation; PAR) was added when the global radiation outside of the glasshouse was lower than 100 $\mu\text{mol m}^{-2} \text{s}^{-1}$ to a maximum day length of 16 hours. *Capsicum* plants were pruned according to common practice in commercial growing (two-stem cultivation).

Experimental design

Within each compartment the experiment was arranged in 44 plots, i.e. four plots per accession. The whole experiment was surrounded with border plants of the 11 accessions to enhance equal growth circumstances. Each plot was again surrounded with border plants of the same accession and contained ten experimental plants of which the largest and smallest plants were removed prior to the second harvest to minimize plant-to-plant variation (Poorter, 1989). Remaining plants were randomly numbered from two to eight representing the order of harvest. Harvests were carried out at 15, 21, 28, 35, 42, 49 and 63 d.a.s. and an additional harvest was performed for the lowered temperature treatment at 100 d.a.s.

Measurements

Two plant parts were distinguished: leaf blades and remaining above ground fraction, which consisted of the main stem, side branches and petioles. At each harvest, plant height was measured as well as the height of the branching point and the number of leaves above and below the branching point. Subsequently, plants were separated into the two fractions and fresh masses of each fraction as well as the areas of the leaf blades (Licor LI-3100 leaf area meter) were determined. Dry masses were determined on oven-dried (48 h at 70 °C) material.

Calculations

Plant growth can be described as an expolinear curve, in which the first growth phase is the exponential growth, changing later into linear growth (Goudriaan & Van Laar, 1994). In this study it was assumed that the exponential growth lasted to 49 d.a.s. and the linear growth started at 49 d.a.s. Relative growth rate, a measure for exponential growth, was calculated as described by (Hunt, 1982). Minimal growth temperature and temperature sum was calculated as described by (Goudriaan & Laar, 1994). Light Use Efficiency (LUE) was calculated as the total dry mass production per unit absorbed PAR (Medlyn, 1998). All statistical analyses (ANOVA, t-test, regression analysis) were performed using the Genstat 6.0. statistical package (Payne *et al.*, 2002).

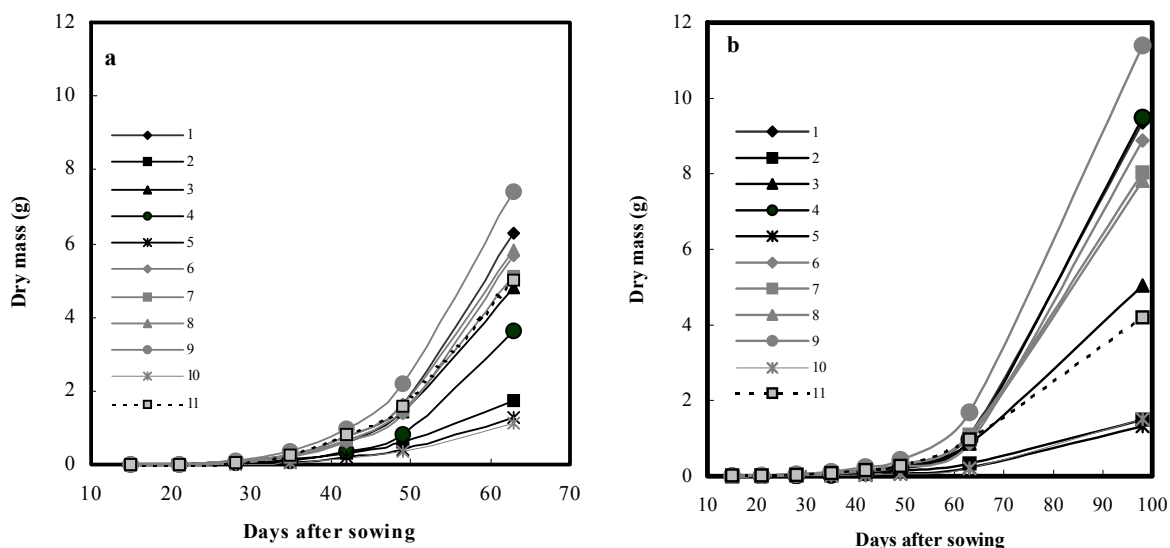

Figure 1: Dry mass development of eleven *Capsicum* accessions in time. Plants were grown under standard (a) or lowered (b) temperatures. Numbers correspond to the codes in table 1.

Result and Discussion

Large differences in growth were found between different accessions and the temperature treatments (Figure 1). At the start of the temperature treatment (15 d.a.s.), no difference in dry mass was found between the temperature treatments. As plants grew bigger, plants grown at the standard temperature had significantly higher dry masses than plants grown under lowered temperatures. Similar results were found by (Nilwik, 1981; Si *et al.*, 1996).

Under standard temperature (Fig. 1a) the final dry mass at 63 d.a.s. varied from 1.14 g for Red Top to 7.24 g for F₁ (PI 585238 x Bruinsma Wonder); At lowered temperature the final dry mass at 98 d.a.s. varied between 1.32 g for *C. chinense* (PI 543184), that normally grows under higher temperatures, and 11.40 g for F₁ (PI 585238 x Bruinsma Wonder).

Exponential growth

Relative Growth Rate (RGR) differed 19 % between the best and worst growing *Capsicum* accession under standard temperatures (Table 2). The F₁ hybrid of the cross between the Dutch sweet pepper and the wild *C. annuum* performed best. The poorest grower was Jatilaba. Under lowered temperatures, this difference was much bigger (28%). *C. chinense* from Bolivia, normally growing at higher temperatures performed poorest while *C. pubescens* normally grown under lower temperatures and known for its ability to grow under low temperatures (Bosland & Votava, 2000) performed best.

Large differences in growth rate were found between plants of the same accession grown under standard and lowered temperatures. *C. pubescens* showed the smallest decrease (23%) in growth rate under lower temperatures compared to standard conditions; Red Top, the accession with the lowest final dry mass at final harvest under standard temperatures showed the largest decrease (41%). This shows that considerable variation for low temperature tolerance is present in *Capsicum*. The two *C. annuum* hybrids in this experiment also performed relatively well in this respect with differences of 28% and 30%.

Table 2: Relative Growth Rate (RGR in mg g⁻¹ d⁻¹) of eleven *Capsicum* accessions grown under standard and lowered temperatures. The percentage of difference within a temperature treatments and between temperature treatments are given.

Species	Standard	Lowered	% Difference ¹⁾
	RGR ± s.e.	RGR ± s.e.	
<i>C. pubescens</i> (PI 585265)	170± 3,7	130± 2,9	23 ^a
<i>C. annuum</i> x <i>C. annuum</i> F1(PI585238 x Bruinsma Wonder)	176± 3,7	126± 2,9	28 ^b
<i>C. annuum</i> x <i>C. annuum</i> F1(Jatilaba x Bruinsma Wonder)	166± 3,8	116± 2,9	30 ^b
<i>C. annuum</i> (PI 585238)	165± 3,7	114± 2,9	31 ^b
<i>C. annuum</i> cv Jatilaba	142± 3,8	97± 2,9	31 ^b
<i>C. baccatum</i> (PI 585248)	169± 3,7	116± 2,9	32 ^b
<i>C. baccatum</i> (PI 585241)	169± 3,7	115± 2,9	32 ^b
<i>C. annuum</i> cv Bruinsma Wonder	175± 3,7	117± 2,9	33 ^b
<i>C. chinense</i> (PI 159233)	161± 3,7	103± 2,9	36 ^b
<i>C. chinense</i> (PI 543184)	149± 3,7	94± 2,9	37 ^c
<i>C. annuum</i> cv Red Top	171± 3,7	101± 2,9	41 ^c
	<i>% difference</i>	<i>19</i>	<i>28</i>

¹ Letters indicate different significant groups (t-test)

The difference in growth rate under standard and lowered temperatures was not correlated with growth rate at standard temperatures, but significantly correlated ($R^2=0.62$) with growth rate under lowered temperatures. This may indicate that at standard temperatures all accessions exhibited their maximal growth rate whereas under lowered temperature conditions those accessions that were adapted to lower temperatures performed relatively better than the non-adapted. In order to select for genotypes that are less influenced by temperature differences it is therefore advisable to select under sub-optimal temperature conditions.

Energy investment

Besides the analysis of plant dry mass data on a time based scale, it is also possible to do analyses on a temperature sum based scale. Using this method, a more direct relation between energy input in the form of heat and dry mass can be found. Temperature sum is the value by which the average day temperature exceeds the minimal growth temperature (in degree-day ($^{\circ}\text{Cd}$)) summed over the growth period (Goudriaan & Van Laar, 1994). The minimal growth temperature for the *Capsicum* accessions used in this experiment was determined at 14.6°C . No significant difference in this threshold level was found between the different accessions. The relation between dry mass and temperature sum is shown in Figure 2. At corresponding temperature sums plants grown under lowered temperatures (Fig. 2b) are significantly larger than plants grown under standard temperatures (Fig 2a).

One of the possible explanations for this difference is that plants grown under lowered temperatures adapt to these conditions by increasing their energy efficiency. One of the ways to do this is by increasing their light use efficiency (LUE). LUE is a measure for the amount of dry mass that can be produced per total unit intercepted PAR. Light interception itself is largely dependent on leaf size. In this study we found that plants grown under lowered temperatures had a significantly higher LUE than plants grown

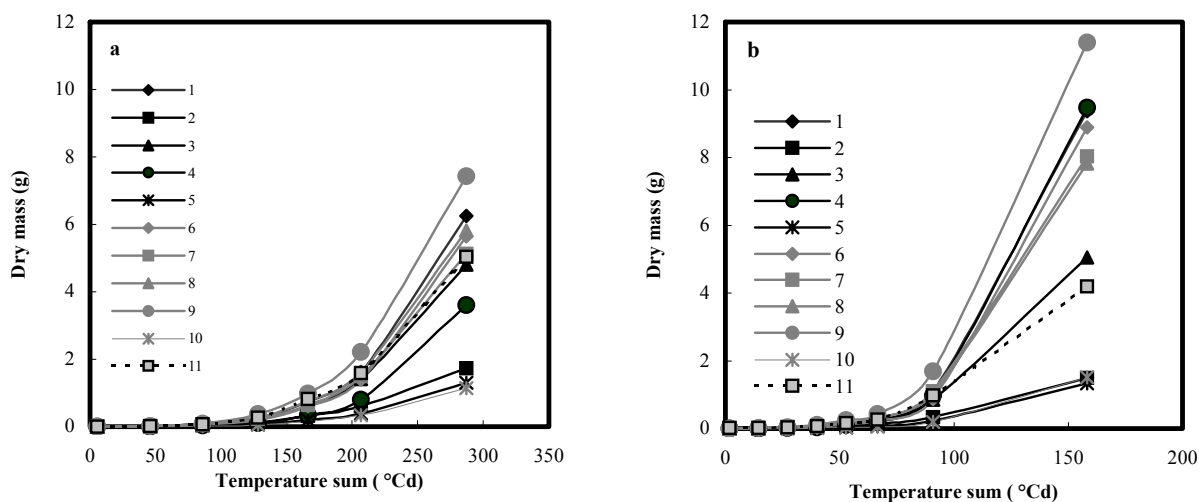

Figure 2: Dry mass development of eleven *Capsicum* accessions plotted against temperature sum. Plants were grown under standard (a) or lowered (b) temperatures. Numbers correspond to the codes in table 1.

under standard temperatures during the exponential growth phase indicating that they used the intercepted light more efficiently than plants grown under standard temperatures. This shows that *Capsicum* plants grown under lowered temperatures can indeed adapt to these conditions.

References

- Atkin, O.K., Botman, B., Lambers, H., 1996. The causes of inherently slow growth in alpine plants: An analysis based on the underlying carbon economies of alpine and lowland *Poa* species. *Functional Ecology* 10, 698-707.

- Bhatt, R.M., Srinivasa Rao, N.K., 1993. Response of bell-pepper (*Capsicum annuum* L.) photosynthesis, growth, and flower and fruit setting to night temperature. *Photosynthetica* 28, 127-132.
- Bosland, P.W., Votava, E.J., 2000. Peppers : vegetable and spice capsicums. Wallingford [etc.] : CABI Publishing, 204 pp.
- Goudriaan, J., Van Laar, H.H., 1994. Modelling potential crop growth processes. Kluwer Academic Publishers, Dordrecht, 238 pp.
- Grime, J.P., Hunt, R., 1975. Relative growth rate: Its range and adaptive significance in a local flora. *Journal of ecology* 63, 393-422.
- Hunt, R., 1982. Plant Growth curves. the functional approach to plant growth analysis. In: Hunt, R. (Ed.). Edward Arnold, London, pp. 5-60.
- Loveys, B.R., Scheurwater, I., Pons, T.L., Fitter, A.H., Atkin, O.K., 2002. Growth temperature influences the underlying components of relative growth rate: an investigation using inherent fast- and slow-growing plant species. *Plant, Cell and Environment* 25, 975-987.
- Medlyn, B.E., 1998. Physiological basis of the light use efficiency model. *Tree physiology* 18, 167-176.
- Nilwik, H.J.M., 1981a. Growth analysis of sweet pepper (*Capsicum annuum* L.). 1. The influence of irradiance and temperature under glasshouse conditions in winter. *Annals of Botany* 48, 129-136.
- Payne, R., Murray, D., Harding, S., Baird, B., Soutar, D., Lane, P., 2002. GenStat® for Windows(tm) (6th Edition) - Introduction. VSN International, ISBN 1-904375-06-5.
- Poorter, H., 1989. Plant growth analysis: Towards a synthesis of the classical and the functional approach. *Physiologia plantarum* 75, 237-244.
- Si, Y., Heins Royal, D., 1996. Influence of day and night temperatures on sweet pepper seedling development. *Journal of the American Society for Horticultural Science* 121, 699-704.
- Tarchoun, N., Jemmali, A., Daly, N., Bodson, M., 2000. Effects of low night temperature on plant growth of *Capsicum annuum* L. *Capsicum and eggplant newsletter* 19, 27-30.

Eggplant (*Solanum melongena*) fruit colour: pigments, measurements and genetics

Marie-Christine Daunay¹, Serge Aubert², Anne Frary³, Sami Doganlar³, Richard N. Lester⁴, Gerard Barendse⁵, Gerard van der Weerden⁵, Jean-Winoc Hennart⁶, Jair Haanstra⁷, François Dauphin¹; Evelyne Jullian¹

¹ I.N.R.A., Génétique et Amélioration des Fruits et Légumes, BP 94, 84143 Montfavet Cedex, France; ² INRA, Sécurité et Qualité des Produits Végétaux, Domaine St Paul, site Agroparc, 84914 Avignon Cedex 9, France; ³ Department of Molecular Biology and Genetics, Izmir Institute of Technology, Gulbahcekoyu Campus, Urla 35437, Izmir, Turkey; ⁴ University of Birmingham Botanic Gardens, B15 2RT Birmingham, UK; ⁵ Botanical and Experimental Garden University of Nijmegen, Toernooiveld 11, 6525 ED Nijmegen, The Netherlands; ⁶ Vilmorin Clause & Cie, Centre de Recherches de la Costière, 30210 Ledenon, France, ⁷ Rijk Zwaan seed Cy, Postbus 40, 2678 ZG De Lier, Netherlands. Contact : daunay@avignon.inra.fr, Tel +33 4 32 72 27 24

Abstract: Eggplant fruit colour is highly variable, both for qualitative as well as for quantitative aspects. Pigment chemistry explains part of the many nuances which are discernible by eye between green fruited cultivars, and even more between the so called “violet-purple” fruited cultivars. Phenotypic complexity of eggplant fruit colour (at commercial stage) can be reduced into four main parameters (1) anthocyanin production in fruit epidermis, (2) anthocyanin production under the calyx, (3) chlorophyll production in fruit flesh, and (4) chlorophyll distribution (uniform, reticulated, ...). Colour measurement methods are numerous, but whatever their subjective (eye) or objective (physical) basis, they present limits and must be chosen by the end-user in accordance to the type of material used and to the research purpose. Some crosses made recently at INRA provided suitable segregation progenies for dissecting the inheritance of the main fruit colour components. Anthocyanin presence (*vs* its absence) is under monogenic dominant control (gene provisionally symbolized *A*). Anthocyanin presence under the calyx (*vs* its absence) is under the control of a monogenic dominant gene (symbol *Puc*). Green flesh is monogenic dominant (symbol *G*) over the white flesh. The reticulated distribution of chlorophylls (*vs* the not reticulated one) is under monogenic dominant control (symbol *Gv*). Some of these genetic factors have been already located on the eggplant molecular map, and putative orthologous counterparts in other Solanaceae identified.

Keywords: *Solanum melongena*, *Solanum linnaeanum*, Solanaceae, anthocyanin, chlorophyll, fruit colour, heredity, genetic control, QTL, mapping, orthology, syteny.

Introduction

The objectives of this paper are (1) to address the question of the complexity of eggplant fruit colour and to give a critical overview of the different methods available for measuring it, and (2) to present some analytical results obtained with progenies from three crosses segregating for fruit colour, and to match their heredity interpretation with previous results as well as with recent QTL analysis.

Pigments involved, variation and perception by eye

Eggplant fruit colour before physiological maturity is very diverse. Except for white fruited eggplants, the epidermis of which contains no pigments, two main pigments are involved in the fruit colour, the chemistry of which is quite complex.

The violet colour is due to anthocyanin pigments, which are flavonoids (polyphenolic compounds) located in the cell vacuoles of the fruit epicarp (skin). The more cell layers contain the pigments and the more pigments, the darker the fruit. For eggplant, the main aglycone of anthocyanins is the delphinidol, of bluish-violetish colour. Depending on the eggplant variety, a variable number of various heterosides are linked to delphinidol (e.g. delp.-3 rutinose, delp.-5 glucose-3 rutinose, delp.-5 glucose-3 cafféoyl glucose), producing colours such as pink, reddish, purple, bluish or violet, that can be perceived by the eye (Aubert, 1971). Those heterosides can be acylated by phenolic acids such as paracoumaric acid (e.g. delp.-5-glucoside-3 (4(p-coumaryl) L-rhamnosyl-(1-6)-glucoside). Each molecular entity composed by these elements linked to the anthocyanin nucleus (e.g. delphinidol) bears a specific pigment name, such as for instance 'nasunine' for delp.-3diglucoside acylated by coumaric acid (Kuroda & Wada, 1933 quoted by Aubert 1971). Anthocyanin chemical stability depends on the number and the position of sugars and acylated molecules, linked to the aglycone. Light, temperature, enzymes, and bruises of epidermal cells, have a strong influence on anthocyanin oxidation processes.

Eggplant fruit colour is also influenced by the presence or the absence of chlorophyll pigments (chlorophylls a and b) which are located in the sub-epidermal cell layers. In absence of anthocyanins, or if those latter are only lightly present, the green pigments can be seen directly in the fruit skin. However, when the anthocyanins are present in quantity, it becomes difficult to determine whether or not there are chlorophylls. In this case, chlorophyll presence can be assessed either by looking at the style scar at the top of the fruit, or by cutting the fruit longitudinally and observing flesh colour (green when chlorophylls are present, white when they are absent). As chlorophylls offer a dark background to anthocyanins, their presence reinforces the visual impression of fruit darkness.

Distribution of anthocyanins or chlorophylls may be uniform or not. If not uniform, it can be reticulated (synonym netted), striped or irregular. Depending on the genotype, light can influence anthocyanin production, since it activates different enzymes involved in anthocyanin biosynthesis. Thus some fruit parts may be less coloured than others when shaded (irregular colour distribution), and under the calyx anthocyanins can even be totally absent.

Growing conditions strongly influence pigment synthesis or catabolism. For instance, inadequate light (due to excessive vegetation or other shading), temperatures and fertilization, as well as diseases may contribute to fruit colour defaults (light colour, stains).

During post harvest fruit storage, anthocyanins start to undergo a catabolism process: the more anthocyanins in the epidermis, the less discernible the colour intensity decrease, and the less depreciation of the fruits commercial value.

When the fruit turns physiologically ripe, anthocyanins and chlorophylls fade and give rise to yellow pigments. These are (1) degraded anthocyanins and chlorophylls, and (2) brown polyphenolic pigments located in the sub-epidermic cell layers which induce a brown colour. For originally white or green fruits, which turn bright yellow when ripe, xanthenes and carotenoids are probably involved.

Perception of fruit colour by eye is influenced by many factors, in particular (1) the colour of the pigments, (2) the quantity of the pigments present, (3) the glossiness of the waxy cuticle and (4) by the illumination of the fruit (in both colour temperature and intensity).

From Aubert (1971); Aubert & Pochard (1981); Gross (1987); Mazza & Miniati (1993); Molla *et al.* (1990); Nagashima & Taira (1965); Nothman *et al.* (1976); Sakamura *et al.* (1963); Tanchev *et al.* (1970); Watanabe *et al.* (1966); among other references.

Colour description and measurements

Fruit colour can be split into four main components: (1) the predominant colour (which can vary from green or white to all nuances of purple and violet to black), (2) the intensity of this predominant colour, (3) the additional colour (with the same range of variation as the main colour), and (4) the distribution of the colour. Other attributes are (5) the fruit colour intensity under the calyx and (6) the flesh colour (green if chlorophylls are present, or white if absent). These six criteria allow a first distinction between major colouration patterns, despite some subjectivity of the observer, in particular in assessing colours such as purple, violet, mauve etc.

It is possible to determine the colour by using a standard printed colour chart such as the Methuen Handbook. However, there are many internet sites with colour codes (e.g. <http://html-color-codes.com>), which can be used to produce a personalized printed colour chart. The hexadecimal HTML colour codes are particularly convenient, since the colours are well defined and can be HTML generated on websites (computer screens) and then printed and laminated (and, if necessary, reprinted after fading) for easy use outdoors. It offers many colour nuances (based on the combination of well established proportions of basic colours) among which one can choose the best adapted ones. However, the glossiness and the luminance of the paper on which the colours are printed, the ink (e.g. printer) and stability of the colours with time have an uncontrolled influence on such personalized colour charts, and therefore limit their reliability.

The above methodology of fruit colour description is well adapted to the characterization of the diversity of *S. melongena* germplasm, as dealt with by a gene bank. It provides data that can be searched for in a database, with more or less detail depending on the needs of the end user. However, its main fault is the subjectivity of the record (variable from one observer to another, and influenced by light quality, intensity, incidence angle, etc.).

A good alternative is provided by colorimetric devices, based on completely standardized methodologies, and providing numerical data. Of relatively easy use, they are objective, precise and yield reproducible results, all qualities the human eye lacks. Different types of chromameters are available, which work either on light reflection or light transmission basis of a small portion of the fruit epidermis. The more repetitions on each fruit, the more precise the measurement. Based on the tri-stimulus methodology, these devices deliver two chromatic coordinates, as well as a luminance value ($L^*a^*b^*$ representation, agreed by CIE -International Commission of Lighting-), but they do not deliver any information about pigment constitution. The use of these devices is difficult when fruit colour is not uniformly distributed.

However, any all these methods are inadequate to detect colour intensity differences between the very dark fruited varieties preferred in western markets. Indeed, as soon as fruit colour intensity is saturated (low luminance value), no differences can then be detected, neither by eye nor by colorimetry. In this case, the use of other devices, based on light transmission of extracts of the pigments contained in the epidermis and upper layers of the mesocarp becomes necessary. Pigment extraction (in acid ethanolic solvent) must be standardized as much as possible (age of the fruit, spatial sampling of

epidermis pieces, surface of those pieces, etc.). Pigment extract is then scanned by a spectrophotometer (focused on given wavelengths) or a spectrophotometer (scanning the whole visible spectrum and yielding a complete absorption spectrum). Pigment concentration is generally expressed in Optical Density (OD) units, linked to specific parameters (fruit surface analysed, dilution of the pigments etc.); it can also be expressed as mg of pigments per epidermis square centimetre. 550 nm matches anthocyanins OD peak, 425 nm and 660 nm match two peaks of pheophytins (form of chlorophylls in acid medium). These devices allow precise comparisons between samples, by giving analytical data based on ODs at precise wavelengths. In the case of high pigment concentration (saturation), further dilutions are used in order to detect differences between samples.

There are other methods that we will not describe here (chromatography, etc.) which are important for separation, characterisation and chemical identification of different pigments, but which are too complex for breeders' usual needs.

As a conclusion, one can say that there is no perfect eggplant fruit colour measurement method (simple, reliable, fast and cheap), and that among the many potentially usable methods, the choice will differ depending on the end-user (breeder, germplasm manager, chemist) and on the varieties concerned (dark commercial cultivars as against general germplasm of various colours).

From Aubert (1976); Aubert (1982); Aubert & Nicolas (1984); Aubert *et al.* (1989); Aubert *et al.* (1992); Francis (1980); Nothman *et al.* (1976); Kornerup & Wanscher (1984); Wintermans & De Mots (1965); among other references.

Genetic analysis: experiments, results and discussion

Material and methods

Plant material (Table 1)

Four *S. melongena* accessions from the INRA germplasm collection have been used, as well as one accession of *S. linnaeanum*, yielding three crosses out of which all F₂, some backcross progenies and some F₁ hybrids, were studied (Table 1).

Measurement of fruit colour

Fruit colour as perceived by the eyes, was recorded as follows:

1. anthocyanins in fruit epidermis: present versus absent
2. anthocyanin under the calyx: present (whatever the intensity) versus absent. This criterion is an indirect way to assess the sensitivity of anthocyanin synthesis to light.
3. chlorophyll in the flesh (present versus absent) after having cut the fruit longitudinally. This criterion is more reliable than chlorophyll in fruit epidermis, the record of which is troubled by the presence of anthocyanins.
4. repartition of the chlorophyll. Reticulation means that fruit shoulders are strongly coloured, but that the colour separates into netting towards the apical fruit scar. It is particularly clear when the fruit has no or only a weak violet colour. Though in absence of reticulation the colour might be distributed in different ways, we have here simplified the record to only reticulation present versus absent.

Results and discussion

Table 1: synthetic results concerning the fruit colour traits segregations found in the progenies studied.

All segregations obtained are not significantly different from the theoretical ratios tested ($P=0,05$); Test χ^2 .

genotypes and progenies	Number of plants	Ratio tested present : absent	Anthocyanin in epidermis	Anthocyanin under calyx	Chlorophyll in flesh	Reticula- tion
MM 195 <i>S. Linnaeanum</i>	8		absent	-	present	present
MM 738 <i>S. melongena</i>	8		present	present	present	absent
F ₁ MM 195 x MM 738	not studied	-	-	-	-	-
F ₂ MM 195 x MM 738	97	3 : 1	$\chi^2 = 0,03$		not appropriate	$\chi^2 = 0,28$
F ₂ MM 195 x MM 738	72 (violet fruits)	3 : 1		$\chi^2 = 0,07$		
Dourga <i>S. melongena</i>	16		absent	-	absent	-
MM 738 <i>S. melongena</i>	16		present	present	present	absent
F ₁ Dourga x MM 738	16		present	present	present	absent
F ₂ Dourga x MM 738	180	3 : 1	$\chi^2 = 0,12$		$\chi^2 = 0,27$	not appr.
F ₂ Dourga x MM 738	137(violet fruits)	3 : 1		100% present !		
446-3 <i>S. melongena</i>	10		present (weak)	present	absent	absent
Ronde de Chine <i>S. mel.</i>	10		present (strong)	absent	present	absent
F ₁ 446-3 x Rde de Ch.			present (medium)	present	present	not appr.
F ₂ 446-3 x Rde de Ch.	135	3 : 1	Not appropriate		$\chi^2 = 0,003$	not appr.
F ₂ 446-3 x Rde de Ch.	127(violet fruits)	3 : 1		$\chi^2 = 0,07$		
BC ₁ = (F ₁ x 446-3)	105	100% present	(100% violet)	99 %		not appr.
BC ₁ = (F ₁ x 446-3)	105	1 : 1			$\chi^2 = 0,01$	
BC ₁ = (F ₁ x Rde de Ch.)	30	1 : 1	(100% violet)	$\chi^2 = 0,13$		not appr.
BC ₁ = (F ₁ x Rde de Ch.)	30	100% present			100% present	

The results displayed in Table 1 allow the following conclusions to be made:

1. anthocyanins in fruit epidermis (present *versus* absent), is controlled by a single dominant gene. This was tested in three progenies (F₂ MM 195 x MM 738, F₁ and F₂ Dourga x MM 738).
2. anthocyanins under calyx present (whatever their intensity) *versus* absent, is controlled by a single dominant gene. For the progenies segregating for anthocyanin presence in epidermis (F₂ of the three crosses) the test has been carried out only for the plants with violet fruits (see for each F₂ the second line in Table 1) since of course the presence of anthocyanin under calyx can only be assessed when anthocyanin is present in the fruit skin. For the BCs (F₁ x 446-3) and (F₁ x Ronde de Chine), no segregation was observed for anthocyanin presence in fruit, therefore the test for the presence of anthocyanin under calyx has been carried out on all plants (for each BC, see first line in Table 1). The case of F₂ Dourga x MM 738 is interesting since all the plants with violet fruits (137 out of 180) have anthocyanins under the calyx. This result indicates that though a white variety, Dourga carries the same allele controlling anthocyanin presence under calyx as MM 738.
3. chlorophylls in flesh (and epidermis): present *versus* absent. Tested on the progenies from the crosses Dourga x MM 738 (F₁ and F₂), and 446-3 x Ronde de Chine (F₁, F₂ and BCs), the results indicate monogenic dominant control. One result (not shown in Table 1) could not be explained: for one plant (out of 97) of F₂ MM 195 x MM 738, chlorophylls were absent, though chlorophylls are present in both parents.

4. reticulation of the chlorophyll (*versus* not reticulated, whatever the other distribution), which could be tested only on the F₂ MM 195 x MM 738, is controlled by a single dominant gene.

The monogenic dominant control for anthocyanin presence (*versus* absence) in fruit epidermis found here is most probably an over-simplified result for several reasons (limited range of fruit colour combinations crosses, anthocyanin intensity not taken into account, ...). Indeed, Tigchelaar (1968) who worked on more plant organs (flowers, hypocotyls; etc.) reported an oligogenic control by three complementary and independent multiallelic genes (called *D*, *P* and *Y*) affecting anthocyanin presence in fruit and in other plant parts, as well as the effect of another gene (*Ac*) influencing purple nuances. He reported also two other dominant multiallelic genes affecting colour intensity. This complexity is also suggested by Tatebe (1944) who obtained a purple F₁ and purple *versus* green segregating progenies in a cross between two green varieties. However, for the time being and despite these reservations, for simplifying the rest of the discussion we will name the gene controlling fruit anthocyanin presence in our experiments ‘anthocyanin’ (symbol *A*).

Our other results match with the genes reported by Tigchelaar (1968): gene ‘Pigment under calyx’ (symbol *Puc*) controlling anthocyanins presence under calyx, gene ‘Green’ (symbol *G*) controlling the formation of chlorophylls in the flesh, and gene ‘Green variegation’ (symbol *Gv*) controlling the reticulated pattern of chlorophyll.

For the chlorophyll reticulation pattern, the wild species *S. linnaeanum* is dominant to the domesticated *S. melongena*, supporting the paradigm that domestication usually involves loss of gene function or regulation (Lester & Daunay, 2003).

Independence between some genes has been tested when the cross combinations were suitable for this purpose (Table 2). Anthocyanin presence (putative gene *A*) is independent of chlorophyll presence (putative gene *G*), chlorophyll reticulation (putative gene *Gv*) and anthocyanin presence under calyx (putative gene *Puc*). However, as *Puc* effect is invisible in the absence of *A*, these two genes relate with an epistatic relationship. Relationships between *Puc* and other putative genes (*G*, *Gv*) have been studied only on the progeny individuals expressing *A* (violet fruits): *Puc* also seems to be independent of *G* & *Gv*.

Table 2: Test of independence between the different genes involved in eggplant fruit colour.

All segregations obtained are not significantly different from the theoretical ratios tested ($P=0,05$); Test χ^2 . For simplifying the presentation, we write the phenotype using the gene symbols into [], though allelism between the genes found in our material with those described by former authors has not been proven.

A Anthocyanin present in fruit epidermis // *A*⁺ absent

Puc anthocyanins present under calyx, whatever their intensity // *Puc*⁺ absent

G Green flesh present // *G*⁺ absent (i.e. white flesh) - *Gv* green variegation (netting) present // *Gv*⁺ absent

gene	A	expected ratio	ratio obtained	χ^2 value
<i>G</i>	F ₂ Dourga [<i>A</i> ⁺ , <i>G</i> ⁺] x MM 738 [<i>A</i> , <i>G</i>] all 180 plants	9 [<i>A</i> , <i>G</i>] : 3 [<i>A</i> , <i>G</i> ⁺] : 3 [<i>A</i> ⁺ , <i>G</i>] : 1 [<i>A</i> ⁺ , <i>G</i> ⁺]	103 : 34 : 33 : 10	0,19
<i>Gv</i>	F ₂ MM 195 [<i>A</i> ⁺ , <i>Gv</i> ⁺] x MM 738 [<i>A</i> , <i>Gv</i> ⁺] all 97 plants	9 [<i>A</i> , <i>Gv</i>] : 3 [<i>A</i> , <i>Gv</i> ⁺] : 3 [<i>A</i> ⁺ , <i>Gv</i>] : 1 [<i>A</i> ⁺ , <i>Gv</i> ⁺]	55 : 17 : 20 : 5	0,45
gene	<i>Puc</i>	expected ratio	ratio obtained	χ^2 value
<i>A</i>	F ₂ MM 195 [<i>Puc</i> ⁺ , <i>A</i> ⁺] x MM 738 [<i>Puc</i> , <i>A</i>] all 97 plants	9 [<i>Puc</i> , <i>A</i>] : 3 [<i>Puc</i> ⁺ , <i>A</i>] : 4 [<i>Puc</i> , <i>A</i> ⁺] & [<i>Puc</i> ⁺ , <i>A</i> ⁺] (●)	53 : 19 : 25	0,10
<i>G</i>	F ₂ Dourga [<i>Puc</i> , <i>G</i> ⁺] x MM 738 [<i>Puc</i> , <i>G</i>] for 137 plants with fruits [<i>A</i>]	3 [<i>Puc</i> , <i>G</i>] : 1 [<i>Puc</i> , <i>G</i> ⁺]	101: 33 & (♥)	0,08
<i>G</i>	F ₂ 446-3 [<i>Puc</i> , <i>G</i> ⁺] x R de Ch [<i>Puc</i> ⁺ , <i>G</i>] for 127 plants with fruits [<i>A</i>]	9 [<i>Puc</i> , <i>G</i>] : 3 [<i>Puc</i> , <i>G</i> ⁺] : 3 [<i>Puc</i> ⁺ , <i>G</i>] : 1 [<i>Puc</i> ⁺ , <i>G</i> ⁺]	71 : 23 : 28 : 5	1,85
<i>G</i>	BC ₁ {F ₁ [<i>Puc</i> , <i>G</i>] x 446-3 [<i>Puc</i> , <i>G</i> ⁺]} all 105 plants have fruits [<i>A</i>]	1 [<i>Puc</i> , <i>G</i>] : 1 [<i>Puc</i> , <i>G</i> ⁺]	51 : 53 : 1 (♦)	0,05
<i>G</i>	BC ₁ {F ₁ [<i>Puc</i> , <i>G</i>] x R de Ch.[<i>Puc</i> ⁺ , <i>G</i>]} all 30 plant have fruits [<i>A</i>]	1 [<i>Puc</i> , <i>G</i>] : 1 [<i>Puc</i> ⁺ , <i>G</i>]	14 : 16	0,13
<i>Gv</i>	F ₂ MM195 [<i>Puc</i> ⁺ , <i>Gv</i> ⁺] x MM738 [<i>Puc</i> , <i>Gv</i> ⁺] for 72 plants with fruits [<i>A</i>]	9 [<i>Puc</i> , <i>Gv</i>] : 3 [<i>Puc</i> , <i>Gv</i> ⁺] : 3 [<i>Puc</i> ⁺ , <i>Gv</i>] : 1 [<i>Puc</i> ⁺ , <i>Gv</i> ⁺]	38 : 15 : 17 : 2	2,62

(●) plants [*Puc*,*A*⁺]and [*Puc*⁺,*A*⁺] cannot be distinguished since they display phenotype [*A*⁺]

(♥) three outsiders were found: one plant [*Puc*⁺,*G*⁺], 2 plants [*Puc*⁺,*G*]

(♦) one plant [*Puc*⁺,*G*] was found

So far, western breeders have concentrated most of their efforts on dark purple and green fleshed material, therefore all these subtleties about eggplant colours have not been essential. However the extension of their seed market to countries where other fruit colours are preferred, may change their challenge. The work of Tatebe (1944), of Tigchelaar (1968), the results presented here, as well as the guide chart for colour combinations in hybrid eggplants (Sambandam, 1967) and probably some other references not quoted here, provide a basis for such extended breeding purposes. Details of colour distribution variations deserve further investigation (here we concentrated only on the chlorophyll reticulation, though other colour distribution patterns were observed). For future connections between the results of different scientists on this topic, it is important that a common vocabulary is adopted for what reticulated (or netted, or variegated), striped (dot-lined), and irregular mean.

Doganlar *et al.* (2002), using molecular markers for mapping eggplant agronomic traits on the same progeny MM 195 x MM 738 used here, provide complementary information at the molecular level. For fruit anthocyanin presence, they identified a QTL (named *fap10.1*) explaining 86-93% of the variation (depending on the experiment), having a dominant action, and located on eggplant Linkage Group 10. This QTL matches with the *A* dominant gene, described here. Although additional loci for fruit anthocyanin intensity (*fai1.1*, *fai10.1* and *fai12.1*) were also found throughout the genome, they had minor effects compared to that of *fap10.1*. These results confirm that anthocyanin presence and accumulation are controlled by several different genetic factors in eggplant, as already stated by Tigchelaar (1968) on a Mendelian basis. Doganlar *et al.* (2002) also

studied the phenotypic variation for anthocyanin presence and intensity on other organs than fruits (leaf lamina, leaf ribs, stem anthocyanins, prickly anthocyanins, corolla anthocyanins) and found that the related QTLs tend to cluster on LG10 (in the vicinity of *fap10.1*), and to a lesser extent on LG6. This clustering may reflect pleiotropic effects of one or more anthocyanin pathway-related loci at these locations.

For the trait ‘fruit reticulation’ (unfortunately mis-named ‘fruit stripes’ in Doganlar *et al.*, 2002, and which corresponds to the green variegation reported by Tigchelaar (1968)), two QTLs have been found: *fst4.1* (explaining 49-67% of the variation, depending on the experiment) which could correspond to gene *Gv*, and a less reliable QTL, *fst10.1* explaining 25% in one out of two experiments. The *S. linnaeanum* allele (MM 195) for *fst4.1* is dominant and matches with the dominant gene found here, and named *Gv* by former authors.

Two eggplant fruit colour loci have putative orthologs in other solanaceous species. The major fruit stripe locus *fst4.1* shows conservation with tomato and has two potential counterparts: *Fs* (fruit stripes) and *u* (uniform ripening) which are tightly linked on chromosome 4. Further research is needed for determining which of these genes is the more likely ortholog to eggplant *fst4.1*. The major anthocyanin QTL on LG10 (*fap10.1*) appears to have two potential counterparts in tomato: *af* (anthocyanin free) and *ag* (anthocyanin gainer), where the two tomato chromosomal regions containing these genes are found together on eggplant LG10. In addition, the *ag* locus of tomato appears to be orthologous to the *A* gene of pepper and the *I*, *F* and *B* genes of potato (Borovsky *et al.* 2004, De Jong *et al.* 2004). Recent research on the pepper and tomato genes suggests that both of these loci correspond to the *Petunia an2* gene, a Myb domain transcriptional regulator of the anthocyanin pathway (Borovsky *et al.* 2004, De Jong *et al.* 2004).

Those syntenic patterns between different solanaceous species can speed up the understanding of the genetic controls involved in anthocyanin synthesis and expression.

Acknowledgements

This work has been supported by the European Union contract RESGEN 113. The authors thank Michel Pitrat for his scientific advices, and the experimental of the INRA Unit on Genetics and Breeding of Fruits & Vegetables, for taking care of the plants.

References

- Aubert S., 1971: L'aubergine. I-Composition et facteurs de qualité. Ann. Technol. Agric. 20 (3): 241-264.
- Aubert S., 1976: Influence de la couleur des aliments et boissons sur leur acceptabilité: quelques exemples. Cah. Nutr. Diét. XI (1): 15-30.
- Aubert S., 1982: La couleur: critères de qualité des fruits, légumes et dérivés. Information Couleur (n° special). Revue du centre français de la couleur, 16: 6-10.
- Aubert S., Amiot M.J., Nicolas J., 1992: Les critères de brunissement des pommes. Science des aliments 12: 625-647.
- Aubert S., Dauplé P., Ginoux G., Laurent R., 1989: Influence de conditions culturales (greffage, irrigation) sur quelques critères de qualité de l'aubergine (couleur, fermeté, brunissement). PHM Revue Horticole 302 : 35-39.
- Aubert S., Nicolas J., 1984: Critères colorimétriques de tri qualitatif automatisable sur quelques légumes : revue (recherche et développement actuel en France). Symposium on postharvest handling of vegetables, Montreal (Canada) 1984/06/03-08 Acta Horticulturae, 157: 83-92.

- Aubert S., Pochard E., 1981: Problèmes de conservation en frais de l'aubergine (*Solanum melongena* L.). PHM Revue Horticole, 215 : 33-40.
- Borovsky Y., Shamir M.O., Ovadia R., De Jong W., Paran I., 2004: The A locus that controls anthocyanin accumulation in pepper encodes a MYB transcription factor homologous to Anthocyanin2 of Petunia. Theor. Appl. Genet., published on line 3 March 2004.
- De Jong, W., Eannetta, N., De Jong, D., Bodis, M., 2004: Candidate gene analysis of anthocyanin pigmentation loci in the Solanaceae. Theor. Appl. Genet. 108: 423-432.
- Doganlar, S., Frary, A., Daunay, M.-C., Lester, R. N., Tanksley, S.D., 2002: Conservation of gene function in the Solanaceae as revealed by comparative mapping of domestication traits in eggplant. Genetics, 161: 1713-1726.
- Francis F.J., 1980: Colour evaluation of horticultural crops. Hortscience 15: 58-59.
- Gross J., 1987: Pigments in fruits. Academic Press. pp.82-84.
- Kornerup A., Wanscher J.H., 1984: Methuen Handbook of Colour. 3rd edition, Eyi Methuen Ltd. 252p.
- Lester R.N., Daunay M.C., 2003: Diversity of African vegetable *Solanum* species and its implications for a better understanding of plant domestication. In Knüpfer H. & Ochsman J. (Eds): Rudolf Mansfeld and Plant Genetic Resources. Schriften genet. Ressourcen 22: pp.137-152.
- Mazza G., Miniati E., 1993: Anthocyanins in fruits, vegetables and grains. Ed. CRC Press Boca Raton, Ann Arbor, London, Tokyo: 301-303.
- Molla E., Esteban R.M., Cisneros M.D., Lopez-Andreu F.J., 1990: Evolucion del color durante el desarrollo de frutos de berenjena. Rev. Agroquim. Tecnol. Aliment. 30 (4): 492-500.
- Nagashima Y., Taira T., 1965: On the pigments of eggplant. Eiyo to shokuryo, 17 (6): 420-422.
- Nothmann J., Rylski I., Spigelman M., 1976: Color and variations in color intensity of fruits of eggplant cultivars. Scientia Horticulturae 4: 191-197.
- Sakamura S., Watanabe S., Obata Y., 1963: The structure of major anthocyanin in eggplant. Agric. Biol. Chem. 27 (9): 663-335; 1965, 29: 181; 1966, 30 (4): 420-422.
- Sambandam C.N., 1967: Guide chart for color combinations in hybrid eggplants. Economic Botany, 21: 309-311.
- Tatebe T., 1939: On inheritance of color in *Solanum melongena* Linn. Jap. Jour. Genet. 15: 261-271.
- Tatebe T., 1944: Further studies on inheritance of color in *S. melongena* Linn. Jap. Jour. Genet. 20: 1-7.
- Tanchev S., Ruskov P.J., Timberlake C.F., 1970: The anthocyanin of Bulgarian aubergine (*Solanum melongena*). Phytochemistry (9): 1681-1682.
- Tigchelaar E.C., Janick J., Erickson H.T., 1968: The genetics of anthocyanin coloration in eggplant (*Solanum melongena* L.). Genetics (60): 475-491.
- Watanabe S., Sakamura S., Obata Y., 1966: Structure of acylated anthocyanins in eggplant and perilla, and the position of acylation. Agric. Boil. Chem. 30 (4): 420-422.
- Wintermans J.F., De Mots A., 1965: Spectrophotometric characteristics of chlorophylls a & b and their pheophytins in ethanol. Biochim. Biophys. Acta, 109: 448-453.

Incomplete anthocyaninless mutations in *Capsicum annuum* l. X *C. chinense* jacq. hybrids

Roumiana Pandeva

Institute of Genetics, Bulgarian Academy of Sciences, Sofia 1113, Bulgaria. Contact: r.pandeva@netcourrier.com

Abstract: Uniform colour mutations were found in the segregating progenies of interspecies hybrids *Capsicum annuum* x *C. chinense* after one backcross with *C. annuum*. Two fully anthocyanin *C. annuum* forms, f. *nigrum* Smith and cv. Zulu (genes *A*, *Mo-A*) were used as female parents. They were pollinated respectively with *C. chinense* accessions PI 315008 and No 23, which differ in purple coloration. PI 315008 possesses considerable anthocyanin amount in stem and fruits. No 23 has anthocyaninless stem, sometimes with anthocyanin shades on the nodes and light-green fruits. Uniform white-greenish flowers, purple stamens and stigma are presented in both *chinense* forms. In F₁ the anthocyanin was spread in all plant parts, but in smaller intensity than in *nigrum* parents, because of the incomplete dominance of *A* and inactivation of *Mo-A*. F₁ plants were backcrossed once with anthocyaninless (gene *al*) *C. annuum*, cv. Albena or line Vibo, anthocyanin free, with light green stems and foliage, white flowers with yellow anthers and pale green (Albena) or sulphury white (Vibo) immature fruits. Wide range of anthocyanin segregation was observed in BC₁P₁F₂ and F₃, from dark purple plants, through varying distribution and intensity of the purple pigmentation on plant parts, to anthocyaninless individuals. Between them single plants were found in both hybrid combinations with anthocyaninless light green stems and foliage, flowers with very pale purplish-cream petals, purple stamens and stigma and light purple fruits on ivory background. Anthocyaninless plants with olive green stem and leaves, flowers with purplish petals, filaments, stigma, blue anthers and anthocyanin-spotted olive green immature fruits were also observed in *C. annuum* x *C. chinense* PI 315008 hybrid. The plants were self-pollinated. Their progeny stably maintained mutant phenotype. Two possible reasons are suggested for the appearance of incomplete anthocyaninless mutations, bearing in mind that *al* locus prevents any purple colour in plants: 1) Existence of different gene control for anthocyanin expression/prevention in *C. chinense*, which explains the almost full lack of anthocyanin except flower coloration in No 23. 2) Differential prevention of anthocyanin expression in stem, foliage, flower and fruit, controlled by a series of alleles/genes with specialised inhibitory function, localised at *al* locus/other loci. Similar mechanism is already suspected to control the accumulation of anthocyanin in various plant organs.

Keywords: *Capsicum annuum*, *C. chinense*, interspecific hybridization, anthocyanin expression, anthocyaninless mutations

Introduction

The 'normal' phenotype of *Capsicum annuum*, consisting of white petals, purple or blue anthers and nodes, and colourless filaments and styles, is controlled by the gene *al*⁺ according to the description of Lippert et al. (1965). The recessive *al* gene affects anthocyaninless mutations. They have been found by Deshpande, Odland (Lippert et al. 1966) and Daskalov (1973). Five other *C. annuum* mutations (*al-1* to *al-5*), not allelic with each other and with Daskalov's mutant, incorporated in cv. Albena, as well as two (*al-6* and *al-7*) in *C. chinense* and one (*al-8*) in *C. chacoense* have been described by Csillery (1980, 1983). They all have green hypocotyls and stem nodes, yellow anthers and no purple spots on immature fruits. Purplish spots could occasionally appear on the nodes and fruits of some genotypes, especially in cold and rainy weather (Daskalov and Poulos 1994). A slight purplish marking along the line of dehiscence has been also observed in *al-5* (Csillery 1980).

An incompletely dominant gene *A* controls the anthocyanin colour of stem, foliage, flowers and immature fruits. In *AA* genotypes its action is intensified by a gene-

modifier *Mo-A*, being ineffective alone (Lippert et al. 1966, Pochard 1977). Additional genes for differential anthocyanin accumulation in flower (*C*, *R₁* and *R₂*), style (*As*), style and filaments (*Asf*) and immature fruits (*F*) have been also reported, some of them redesignated (Lippert et al. 1966) or eliminated (Daskalov and Poulos 1994).

Material and methods

Two completely anthocyanin small-fruited *C. annuum* forms (cv. Zulu and f. *nigrum* Smith) were used as female parents. They had dark purple stems, foliage, flowers and fruits (genes *A* and *Mo-A*). Interspecific hybridisation was realised with two *C. chinense* accessions as pollinators. PI 315008 contains considerable amount of anthocyanin on stem, petioles, sepals, calyx base and on immature ivory-coloured fruits. No 23 has anthocyaninless stem, sometimes with anthocyanin traces on the nodes and light-green fruits. Both specimens are with uniform creamy-greenish flowers and purple anthers, filaments and styles. F₁ hybrids were backcrossed once with anthocyaninless (gene *al*) *C. annuum* mutants (cv. Albena and line Vibo), originating from local kapya-type variety Zlaten medal. Plants are anthocyanin free, with light green stems and foliage and white flowers with yellow anthers. They differ in colour of immature fruits, pale green for cv. Albena and sulphury white for line Vibo.

F₁ and BC₁ plants were grown in pots, in a greenhouse and the segregating progenies – in field conditions. Colour of the different plant organs was visually determined.

Results and discussion

In F₁ of both hybrid combinations *C. annuum* f. *nigrum* Smith x *C. chinense* PI 315008 and *C. annuum* cv. Zulu x *C. chinense* No 23 the anthocyanin was spread in all plant parts, but in smaller intensity than in *nigrum* parents, because of the incomplete dominance of *A* and the inactivation of *Mo-A*, being effective in AA genotypes only (Lippert et al. 1966). 12 plants were obtained after one backcross of F₁ *nigrum* x 315008 with line Vibo, falling into two groups according to stem coloration intensity. Six of them had purple spots in the nodes only. The rest were with purple vascular bundles or with fully anthocyanin stems. Segregation of 7:5 was observed for the presence/absence of anthocyanin in petals, filaments and stigma as well as 9:2 for anthocyanin/anthocyaninless immature fruits. Only three plants were obtained after one backcross of Zulu x No 23 F₁ hybrid with cv. Albena, segregating 2:1 for whole stem/stem node coloration, for anthocyanin/anthocyaninless petals, filaments and stigma, as well as for non purple/purple immature fruits. Despite the insufficient number of BC₁ plants, the lack of uniformity in the distribution of anthocyanin suggests the participation of more genes, controlling this process. Anthocyanin expression was investigated in F₂ and F₃ of BC₁ plants with almost 'normal' and with intense coloration, separately grown as siblings. More uniform segregation was observed in these originating from plants with pronounced purple colour. They could be conventionally separated in two groups, one preserving intense coloration with variations and anthocyaninless one (probably one or more genes, controlling anthocyanin presence/absence being homozygous). Wide range of anthocyanin pigmentation was observed in the progenies of almost 'normal' plants, from dark purple ones, through varying distribution and intensity of the purple colour on plant parts, to anthocyaninless individuals, an indication for the heterosigosity of the initial BC₁ forms. Two plants were found in *nigrum* x 315008 'normal' progenies and one, originating from Zulu x No 23, with uniform mutant phenotype. They were with anthocyaninless light green stems and foliage, flowers with very pale purplish-cream petals, purple stamens and stigma and light purple fruits on ivory background. Another

two plants with anthocyaninless olive green stem and leaves, flowers with purplish petals, filaments and stigma, blue anthers and purple-spotted olive-green immature fruits were also observed in *nigrum* x 315008 hybrid. The plants were self-pollinated. Their progeny stably maintained mutant phenotype.

According to the literature, *al* gene prevents the expression of anthocyanin in any plant organ (Lippert et al. 1966, Daskalov and Poulos 1994). On the other hand the availability of anthocyanin in petals, filaments, stigma and fruits in plants with anthocyaninless stems and foliage suggests an activation of *A* gene. However, it is known that this gene is effective only in the presence of *al*⁺ (Lippert et al. 1966). One of the possible reasons for the appearance of incomplete anthocyaninless mutations is the existence of differential gene control of anthocyanin expression and prevention in *C. chinense*, e.g. partial action of *A* gene (another gene) in the presence of *al*, which could also explain the almost full lack of anthocyanin except flower coloration in No 23. Another feasible explanation is based to the recent investigations of Chaim et al. (2003) and Paran et al. (2003). Using *C. annuum* x *C. chinense* hybrids as initial material they map *A* locus to chromosome 10 of *C. annuum* and suspect the possible localisation of genes *A* and *Fc* (filament colour) to this locus, being allelic. *An2* (*A* gene in petunia) is another likely candidate for the latter locus. These authors also suppose that the differential accumulation of anthocyanin in various organs of pepper plants is most probably controlled by a series of alleles at the same locus. Similar mechanism could exist for differential prevention of anthocyanin expression in stem, foliage, flowers and fruits of pepper plants, controlled by a series of alleles/genes with specialised inhibitory function, localised at *al* locus/other loci.

Incomplete anthocyaninless mutations obtained will be included in hybridisation program in order to investigate the inheritance of mutant phenotypes. The results will give more information about the mechanism, controlling the presence and absence of anthocyanin pigment in pepper.

References

- Chaim, A.B. Borovsky, Y. De Jong, W. & Paran, I. 2003: Linkage of the *A* locus for the presence of anthocyanin and fs10.1, a major fruit-shape QTL in pepper. *Theoretical & Applied Genetics* 106: 889-94.
- Csillery, G. 1980: Gene mapping of the pepper needs more initiatives. (Contribution to the gene list). Proc. IVth Meeting EUCARPIA Capsicum Working Group, Wageningen. pp. 5-9.
- Csillery, G. 1983: New *Capsicum* mutants found on seedling, growth type, leaf, flower and fruit. Proc. Vth Meeting EUCARPIA Capsicum & Eggplant Working Group, 4-7 July 1983, Plovdiv, pp. 127-130.
- Daskalov, S. 1973: Investigation of induced mutants in *Capsicum annuum* L. III. Mutants in the variety Zlaten medal. *Genetics & Plant Breeding* 6: 419-429 (in Bulgarian).
- Daskalov, S. & Poulos, J.M. 1994: Updated *Capsicum* gene list. *Capsicum & Eggplant Newsletter* 13: 15-26.
- Lippert, L.F. Bergh, B.O. & Smith, P.G. 1965: Gene list for the pepper. *Journal of Heredity* 56: 30-34.
- Lippert, L.F. Smith, P.G. & Bergh, B.O. 1966: Cytogenetics of the vegetable crops. Garden pepper, *Capsicum* sp. *Botanical Review* 32: 24-55.
- Paran, I. Borovsky, Y. Chaim, A. B. & De Jong, W. 2003: Genetic and molecular analysis of anthocyanin2 (*an2*) during fruit development in pepper. Proc. 7th International Congress on Plant Molecular Biology, (Barcelona ISPMB 2003 Congress), 23-28.06.2003, S27-3.

Pochard, E. 1977: Localization of genes in *Capsicum annuum* by trisomic analysis.
Annales d'Amélioration des Plantes 27: 256-266.

Phenotypic correlation between capsaicin and dihydrocapsaicin contents in *Capsicum annuum*.

Garcés Claver A.¹, Arnedo Andrés M.S.¹, González C.² and Gil Ortega R.¹

¹ Centro de Investigación y Tecnología Agroalimentaria, Apartado 727,50080 Zaragoza.

² Centro Nacional de Tecnología y Seguridad Alimentaria. Ctra. Nacional 134, 31570, San Adrián, Navarra. Contact: agarces@aragob.es

Capsaicinoids are a type of alkaloid compounds and their accumulation in pepper fruits is responsible for pungency. Although different capsaicinoids profiles have been reported (Collins and Bosland, 1994) capsaicin and dihydrocapsaicin represent over 90% of total capsaicinoids in *Capsicum* fruits. The aim of this work was to determine the possible relationship between capsaicin and dihydrocapsaicin in several *Capsicum annuum* varieties selected with different pungency levels.

C. annuum accessions ‘C-144’, ‘Jalapeño’ and ‘Serrano Criollo de Morelos-334’ (SCM-334) from Mexico, and ‘Lopic’, ‘Padrón’, ‘Pico’, ‘Piquillo Amarillo’ and ‘Sincap’ from Spain were open-air cultivated at three different localities in the Ebro Valley area during two growing seasons. Besides, to give each variety more opportunities to express pungency at different environmental conditions, the individual red mature fruit sample were collected at different dates along the growing season. Capsaicin and dihydrocapsaicin of 896 individual fruits were separated and quantified using HPLC.

‘Lopic’, ‘Sincap’ and ‘C-144’ fruits showed very low or no capsaicinoid content in their samples. Therefore they should be reported as sweet varieties. Results also indicated that the most accessions showed a large range of capsaicinoid variation and also that capsaicin content was higher than dihydrocapsaicin one. Besides, positive phenotypic correlations were always observed between capsaicin and dihydrocapsaicin contents in the pungent varieties. Statistically significant (0.001) and very high correlation coefficients, over 0.96, indicated a strong relationship between capsaicin and dihydrocapsaicin.

These results could be explained by the hypothesis of a common genetic base in the biosynthesis of both capsaicinoids. Nevertheless, when in our study it was computed the ratio of capsaicin to dihydrocapsaicin contents three statistically different groups of pungent varieties were identified. ‘Jalapeño’ and ‘Pico’ constituted the first group, with ratios ranging from 1,26 to 1,28; the second group, ranging from 1,63 to 1,6, constituted by ‘Padrón’ and ‘SCM-334’ and the third one make up by ‘Piquillo Amarillo’ with a ratio of 1,9. It should indicate that the genetic control of the capsaicin and dihydrocapsaicin biosynthesis is partially different even within *C. annuum* species.

References:

Collins M. and Bosland P.,1994. Rare and novel capsaicinoid profiles in *Capsicum*.
Capsicum and Eggplant Newsletter, 13, 48-51.

Comparison of *S. melongena* ‘MM 738’ and *S. linnaeanum* ‘MM 195’ for salinity resistance

Daunay M.C.¹, S. Adamowicz², J. Le Bot, J. Hostalery², J. Fabre²

¹ I.N.R.A., Génétique et Amélioration des Fruits et Légumes, BP 94, 84143 Montfavet Cedex, France

² INRA-Plantes et Systèmes Horticoles, Domaine St Paul, site Agroparc, 84914 Avignon Cedex 9, France

On the basis of the frequent presence of spontaneous populations of *S. linnaeanum* along the Mediterranean sea coasts, this species is assumed to be resistant to salinity. In order to establish objectively the possible difference for salinity resistance between this species and eggplant, an hydroponic experiment in greenhouse was carried out with two accessions, MM 195 (*S. linnaeanum*) and MM 738 (*S. melongena*). As direct sowing in the experimental hydroponic system failed, fresh cuttings were taken out from young plants grown in pots, at a vegetative stage of 7 leaves and introduced in narrow plastic tubes dipping into the running nutrient solution. A screen providing sun protection, as well as a mist system set at 100% air humidity, allowed a fairly good successful rooting of the cuttings within 3 weeks. Salinity treatment was then progressively applied during three weeks, by additions of 50 mM NaCl to the nutrient solution, almost every two days. At the end of the experiment, the salinity of the solution was 650 mM NaCl, *i.e.* 1.2 times the salinity of sea water. For both genotypes, the plastochrone index (PI) evolution was linear up to a salinity threshold of 200-250 mM NaCl, and then remained constant, indicating a stop of the vegetative growth. This criteria proved convenient for assessing plant response to salinity in a simple and non-destructive manner. No statistically significant difference between both genotypes was found, neither for the slope of PI along time, nor for the salinity threshold at which PI increase stopped. At the end of the experiment, both genotypes displayed strong root meristematic necrosis, but apices remained turgid. The symptoms on young and adult leaves differed from one genotype to another. This experiment was not consistent with the claimed putative difference between both species for salinity tolerance. Further experiments should be carried out to confirm our observations under different climatic conditions and vegetative stages.

Colour retention in export oriented Indian Chillies (*Capsicum annuum* L.) as affected by ripening stage

M. Kalpana and M.B. Chetti

Department of Crop Physiology, University of Agricultural Sciences, Dharwad-580 005, Karnataka, India, E-mail : mbchetti_uas@rediffmail.com

India is the only country rich in many varieties with different quality factors. There is a great demand in the international market for Indian chillies due to their attractive red coloured fruits with wrinkles, thick pericarp coupled with less seeds and medium to low pungency. Among them, Byadagi types of Karnataka are premium export oriented varieties rich in oleoresin yield and ASTA colour value. Colour is a very important attribute of chilli fruits which is due to carotenoid pigments synthesized massively during ripening. Ripening of fruits is economically important as a process affecting the quality of fruits as well as the length of time for which they need to be kept on the plant.

Investigations were carried out to find the right stage of harvest for maximum colour retention and the physiological and biochemical reasons associated with the colour development. The experiment comprised of two stages of harvest (1/4th dried fruits on plant and ripe red succulent fruits) in two commercial varieties (Byadagi Kaddi and Byadagi Dabbi). The crop was harvested in four pickings.

Results revealed that oleoresin yield, capsaicin, E.O.A colour value and per cent solids were significantly higher in 1/4th dried fruits on plant compared to ripe red succulent fruits in both the varieties. This could be attributed to the fact that in the fruits left on the plant after turning to ripe red for some more time until they attained physiological maturity (7-8 days for Byadagi Kaddi and 8-10 days for Byadagi Dabbi), there was a better translocation of photo-assimilates and accumulation of metabolites. Further, per cent discolouration and moisture content were higher in ripe red succulent fruits compared to 1/4th dried fruits on plants, indicating that higher moisture content is not desirable for the better quality of fruits. Higher Oleoresin yield and E.O.A colour value in 1/4th dried fruits on plant signify the continuous biosynthesis of carotenoids, if the fruits are left on the plant for a longer period, as they get exposed to extended light periods, nutrient availability and oxygen concentration and fruits accumulate more carotenoids. From the investigation, it is inferred that the fruits have to be harvested at 1/4th dried stage on plant which gives a better scope for complete development of not only size and shape but also quality improvement which in turn provide a margin of safety for packaging, storage and marketing.

Evaluation of Paprika (*Capsicum annuum* var. *longum*) cultivars for processing

S. Padmapriya^{1,2}, N. Chezhiyan³ and S. Subramanian⁴

1. Ph. D. Scholar, Horticultural College and Research Institute, Tamil Nadu Agricultural University, Coimbatore, India. 641 003

2. Email: priyam_75@rediffmail.com

3. Professor and Head, Dept. of Spice and Plantation Crops, Horticultural College and Research, Tamil Nadu Agricultural University, Coimbatore, India. 641 003

4. Associate Professor, Horticultural College and Research Institute, Tamil Nadu Agricultural University, Coimbatore, India. 641 003

A study was undertaken at the Horticultural College and Research Institute, Tamil Nadu Agricultural University, Coimbatore, India to evaluate the suitable paprika (*Capsicum annuum* var. *longum*) genotypes for processing. The genotypes viz., KTPL 18, KTPL 19, Bydagi Kaddi, Bydagi Karnataka, Bydagi Kerala, MDU-Y, MDU – R, Arka Abir, Simla paprika and Tomato chilli were collected and evaluated during Kharif and Summer, 2002. The results revealed that the genotype KTPL 18 recorded the highest value for Ascorbic acid (86.846 %), TSS (9.96⁰ brix), Capsanthin (176.434 ASTA Units), Dry matter (22.70 %). The oleoresin content was the highest in Tomato chilli (28.75 %). The genotype Bydagi Kaddi recorded the highest crude fibre content. The increased TSS could be attributed to enhanced photosynthetic and metabolic activities, resulting in the synthesis of high amounts of organic acids, metabolites and glucose. The ascorbic acid content was found to decrease as the fruit reached maturity. The extractable colour was found to be significantly different in all the 10 cultivars tested. In conclusion, the variety having maximum dry matter, ascorbic acid, increasing colouring matter, rich in alcohol soluble matter is suitable for salad as well as for processing purposes.

Studies on the breeding behaviour of the Chilli (*Capsicum annuum* L.) parents and hybrids in capsaicin synthesis

V. A. Sathiyamurthy^{1,2}, D. Veeraragavathatham³ and V. Sankar⁴

1. Senior Research Fellow, Botanical Garden, Horticultural College and Research Institute, Tamil Nadu Agricultural University, Coimbatore, India. 641 003

2. Email. mugilhort@yahoo.co.in

3. Director, Planning and Monitoring, Tamil Nadu Agricultural University, Coimbatore, India. 641 003

4. Research Scholar, Horticultural College and Research Institute, Tamil Nadu Agricultural University, Coimbatore, India. 641 003

An investigation was carried out at Horticultural College and Research Institute, TANU, Coimbatore, India to analyse critically the breeding behaviour of the parents in capsaicin biosynthesis. The parents *viz.*, Arka Lohit, CC 3, CC 4, CF 53, Pusa Sadabahar, Punjab Lal, CHD 8, Ujwala and PKM 1 were taken for this study. Capsaicin synthetase (CS) is the penultimate enzyme, which involved in the synthesis of capsaicin from vanillylamine. The parent CF 53 recorded the highest value for the CS activity at 30 Days After Flowering and the hybrid CC 3 X Arka Lohit registered the highest value. At 45 DAF it was the highest in the hybrid CC 4 X Pusa Sadabahar. Even though the parent, Pusa Sadabahar and hybrid CC 4 X Pusa Sadabahar exhibited better capsaicin synthetase activity at 45 DAF, they could not surpass the hybrid Arka Lohit X CF 53 in capsaicin recovery from their fruits. In respect of crosses like Punjab Lal X CC 3, Arka Lohit X CHD 8 and Ujwala X CHD 8 which exhibited high capsaicin recovery from dry fruits, the Phenylalanine Ammonia Lyase activity rose up from 15 DAF to 30 DAF and fell down there after. There was a sharp increase in CA₄H enzyme activity at 30 DAF and it was high at 45 DAF as in other hybrids. On the other hand, the CS activity was lesser at 30 DAF in Arka Lohit X CHD 8 and Ujwala X CHD 8. In the case of the hybrid Pusa Sadabahar X CF 53 (another combination with high capsaicin recovery in dry fruit), the PAL activity increased steadily from 15 DAF to 30 DAF.

Peroxidase activity was low in the earlier stages of the fruit growth and later stages it was increased. The activity of the peroxidase was the lowest in CF 53 at 45 DAF and in the hybrid, this was lowest in Punjab Lal X CC 4. In the best performing genotypes for capsaicin recovery, *viz* Arka Lohit X CF 53, Ujwala X CHD 8, Pusa Sadabahar X CF 53, the peroxidase activity was at a lower level at different stages of fruit growth. It was fairly at lower level in 15, 30, 45 DAF as well as at mature green in Arka Lohit X CF 53.

Studies on the capsaicin biosynthesis of Chilli (*Capsicum annuum* L.) hybrids with high pungent for processing industry

V. A. Sathiyamurthy^{1,2}, D. Veeraragavathatham³, M. Jawaharlal⁴, K. Rajamani⁵ and K. R. Rajadurai⁶

1,6. Senior Research Fellow, Botanical Garden, Horticultural College and Research Institute, Tamil Nadu Agricultural University, Coimbatore, India. 641 003

2. Email. mugilhort@yahoo.co.in

3. Director, Planning and Monitoring, Tamil Nadu Agricultural University, Coimbatore, India. 641 003

4,5. Associate Professor, Horticultural College and Research Institute, Tamil Nadu Agricultural University, Coimbatore, India. 641 003

An investigation was carried out at Horticultural College and Research Institute, Tamil Nadu Agricultural University, Coimbatore, India to study the capsaicin biosynthesis in chilli hybrids and their parents. The results showed that the hybrid Ujwala X CF 53 registered the highest capsaicin content at mature green fruit stage while, Arka Lohit X CF 53 recorded the highest capsaicin content at dry fruit. The highest Phenylalanine Ammonia Lyase activity was noticed in the hybrid CHD 8 X Arka Lohit at 30 Days After Flowering (DAF). Among the hybrids KDC 1 X CF 53 recorded the highest CA₄H activity at 15 DAF (2.79 m mol kg⁻¹ min⁻¹) and it was high at 30 DAF in the hybrid Arka Lohit x CF 53. The hybrid, CC 3 X Arka Lohit was noticed for the highest activity of CS enzyme (179.33 m mol kg⁻¹ min⁻¹). Among the parents, the activity of the peroxidase was the lowest in CF 53 at 45 DAF and in the hybrids, it was the lowest in Punjab Lal X CC 4 and the highest in Ujwala X PKM 1. In general, the PAL activity was high in the hybrids, in the earlier stages, which were derived from high activity of PAL activity in the earlier stages of their respective parents. During later stages, the activity showed the ununiform distribution. Peroxidase activity was low in the earlier stages of the fruit growth and later stages it was increased. Inverse relationship between capsaicin content and peroxidase activity that might indicate an involvement of this enzyme in capsaicin degradation.

Isoenzyme studies in capsaicin metabolism of Chilli (*Capsicum annuum* L.) hybrids

V. A. Sathiyamurthy^{1,2}, D. Veeraragavathatham³ and V. Sankar⁴

1. Senior Research Fellow, Botanical Garden, Horticultural College and Research Institute, Tamil Nadu Agricultural University, Coimbatore, India. 641 003

2. Email. mugilhort@yahoo.co.in

3. Director, Planning and Monitoring, Tamil Nadu Agricultural University, Coimbatore, India. 641 003

4. Research Scholar, Horticultural College and Research Institute, Tamil Nadu Agricultural University, Coimbatore, India. 641 003

The electrophoretic patterns of the fruit peroxidases in F₁ hybrids with high capsaicin recovery (Arka Lohit X CHD 8 and Pusa Sadabahar X CF 53) and their corresponding parents were studied. The results revealed that the variation in number as well as intensities of enzyme profiles within parents was relatively more than that of F₁ hybrids. There was appearance of new bands and disappearance of some bands in F₁ hybrids when compared to their parents. The appearance of new bands in genetically reconstituted hybrids can be attributed to the expression of structural genes, which were not expressed previously, or expression of new genes contributed by female parent. The disappearance of some bands in hybrid when compared to their corresponding parents may be due to the negative regulation of gene action or suppression of previously acting genes reconstituted hybrid genome. However from the results of present investigation different hybrids express different banding patterns though they are similar in capsaicin recovery.

Seedlessness as a physiological parameter for enhanced pungency principle, a pharmaceutically useful quality trait, in *capsicum*

G.K. Satpute¹, Neeta-Sharad Dodke, Tishyarakshita and R.G. Satpute^{1,2}

¹ AICCIP, B.M. College of Agriculture, J.N. Agriculture University, Jaswadi Road, Khandwa (M.P.) - 450 001, India, ² E-mail rgsatpute@indiatimes.com

Capsicum annum (x=12) has retained its prominent position in the international arena due to the presence of pharmaceutically important pungency principle- capsaicin, in the fruit, besides its wide uses in the consumption and as a colorant. The world demand for Capsicum is expected to go up to 1,13,000 tonnes by 2005 AD. For extraction industries, high pungency (>1.0% capsaicin) Capsicum offers a direct saving on the unit cost of extraction. The major potential of Indian Capsicum with high capsaicin content, remains yet to be fully exploited with its current low to medium (0.3 to 0.5% capsaicin) pungency levels. Seedlessness in Capsicum may prove to be an essential indirect selection index for breeding of cultivars with high capsaicin content. An experiment was laid out in Randomized Complete Block Design with three replications, using six locally adapted Capsicum genotypes, during 2002-03 cropping season at AICCIP, J.N. Agriculture University, Khandwa (M.P.), India. Major quantitative traits used under study were number of seeds / fruit, length of fruit (cm), width of fruit (cm), mean weight of one fruit (g), mean volume of one fruit (cc), mean density of one fruit (g/cc) and pungency level. The weights and the volumetric measurements were determined on Sartorius Universal balance and by volumetric cylinder method, respectively. Pungency level was estimated by fruit bite method. The data analysis was performed using the experimental design. The range for the decreasing number of seeds /fruit (190.2 - 34.3), as observed to be in an opposite trend to that for the pungency level on 0-5 rating scale with 0 (zero) being non-pungent and 5 being highly pungent over the six genotypes, lead to a hypothesis that the level of auxin in an ovary, necessary for the induction of seedlessness, has a positive enzymatic effect on the metabolic differentiation of capsaicin pathway for high rates of synthesis and accumulation of capsaicin in the fruits. Inverse relationships for width of fruit (cm), mean weight of one fruit (g), mean volume of one fruit (cc) and mean density of one fruit (g/cc) as established with pungency level, has strengthened the criteria for their selection as the determinants of seedlessness. The presence of no relationship between length of fruit (cm) and pungency level signified for the direct selection of desirable length of fruit. The seediness is established in such seedless fruits upon hand pollination for their commercial multiplication under crop improvement programme.

Genetic analysis of Parthenocarpy in Eggplant

Tian Shibing¹, Liu Fuzhong², Wang Yongqing¹, Luo Zhangyong¹, Chen Yikang¹, Liu Junshao¹, and Hong Yunju¹

¹*Chongqing Institute of Agricultural Sciences, Chongqing 400055, China.*

Email: twlcp@yahoo.com.cn.

²*Vegetable and Flower Institute /CAAS, Beijing 100084, China* □

Abstract: Three parthenocarpic lines of eggplant, D-7-1, D-16-3, and D-28, were obtained in different segregant populations. The combining abilities, heritability, correlation, aggression, and path for parthenocarpy were analyzed according to 10 hybrid crosses made between 3 parthenocarpic lines and 2 non-parthenocarpic lines of eggplant with half mating design. The results showed that the heredity of parthenocarpy was not correspondent with the additive-dominant model. Parthenocarpy was mainly controlled by one recessive gene as well as influenced by epistasis effect.

Key words: Eggplant, Parthenocarpy, Genetic analysis

Salt tolerance of sweet pepper varieties

K. Slezak¹, I. Terbe¹, N. Kappel¹ and K. Tóth¹

¹ *BUESPA of Horticulture Science Department of Vegetable and Mushroom Growing H-1118 Budapest, Ménesi u. 44. zold@omega.kee.hu*

In our experiments, we have chiefly tested the salt sensitivity of sweet pepper varieties (Fehérözön, HRF F₁ and Syn. Cecei of white, conical fruit; Boni of white, blunt, infolded fruit; Titán F₁ of pointed, hot fruit; Pritavit F₁ of tomato shaped fruit). In cold forcing, 0,3 l/plant nutrient solutions of different NaCl content were given twice weekly. EC of the nutrient solutions containing 0,25% Volldünger Linz complex fertilizer was made up to 6, 10, 14 and 18 mS/cm, respectively, by 2,51/9,17/17,97/26,76 g/m² doses of pharmacopeal NaCl every week. The solution used for the control treatment (EC 4,4 mS/cm). Irrigation was made with pure water (EC 0,6 mS/cm) when necessary.

In general, the symptoms caused by NaCl treatments (with doses higher than 10 g/m² weekly) have been the following:

- They have reduced the leaf area, the height of the plants, the total and the early yield, the fruit set number per square meter, the average weight of the fruit (and, in some measure, fruit length, too) and the thousand seed weight.
- They have increased the calcium and the chlorine content of the leaves and fruits and the dry matter content of the fruits.
- They haven't affected the dry matter content of the leaves, the nitrogen, phosphorus and potassium content of the leaves and fruits, and the germinating ability of the seed.
- The effect on stem diameter and on seed production per fruit has been contradictory in some cases.

The effects of the intermediate treatments haven't been explicit in several cases.

The results of the examination of cuticular secretion have indicated the increase of the sodium and chlorine content of the leaves. This can be important in field growing where the rainwater may wash out a part of sodium and chlorine from paprika leaves.

The hot, pointed variety and the tomato shaped paprika haven't shown expressly higher salt tolerance than the varieties of white fruit colour.

Sucrose synthase and acid invertase activity in relation to the floral structures abortion in pepper (*Capsicum annuum* L.) grown under low night temperature

N. Tarchoun^{(1)*}; M. Bodson⁽²⁾ and A. Mougou⁽¹⁾

⁽¹⁾ *National Institute of Agronomy, Tunis (INAT)- Tunisia 43, av. Charles Nicolle 1082 cité mahrajène Tunis.*

⁽²⁾ *Agricultural University of Gembloux (FUSAGx) Passage des Déportés 5030 Gembloux -Belgium*

** Corresponding author - Phone: 216 73 348544 /73 348546 Fax:216 73 348691 e-mail address: tarchoun.neji@inat.agrinet.tn or ntarchoun@yahoo.fr*

Abstract: Stress low night temperature induced abortion of buds and flowers buds is an important constraint to the production of pepper (*Capsicum annuum* L.) grown under unheated greenhouse during winter.

Effects of low night temperature were investigated on two local hot pepper cvs (Beldi and Baklouti) grown at day/night temperatures of either low night temperatures regime (LTR: 25°C/10°C) or optimum temperature regime (OTR: 25°C/20°C). Beldi and Baklouti pointed out the negative effect of low night temperature on floral structure differentiation; this effect was more severe on bud stage than on flower bud stage. Abortion of these structures was less important in Beldi than in Baklouti; this result may explain the production delay of Baklouti during winter.

Relationship between structural floral abortion induced by low night temperature and enzymatic activity showed an inverse proportionality between these two parameters; this enzymatic activity was also significantly more elevated in Beldi than in Baklouti. Under these conditions sucrose synthase and soluble acid invertase activities were reduced to 50%, while the insoluble acid invertase activity was reduced to more than 90%.

Correlation study between enzymatic activity and flower abortion showed a differential response between these two parameters according to the developmental stages.

Legumins in pepper (*Capsicum annuum* L.) and eggplant (*Solanum melongena* L.) cultivars

R. Vladova , V Tsanev, K. Petcolicheva and M. Zamfirova

*Doncho Kostoff Institute of Genetics, Bulgarian Academy of Sciences,
1113 Sofia, Bulgaria. E-mail: rvladova@webscs.net*

Legumins (11S globulins) are one of the two main classes seed storage proteins in dicotyledonous plants with M_r about 360 kDa (Derbyshire et al., 1976). They are built up of six units, so called intermediary subunits. Each subunit consists of an acidic and a basic polypeptide joined together via disulphide bond (Shewry et al., 1995). In non-reducing conditions legumins dissociate into intermediary subunits and after reduction - into acidic and basic polypeptides.

Electrophoretic analyses of non-reduced and reduced seed storage proteins in pepper and eggplant cultivars were carried out. Two gel systems - 7.5% acidic gel (Reisfeld and al., 1962) and 12.5% SDS PAAG (Laemmli, 1970), as well as 2-D electrophoresis were applied. Electrophoretic spectra of non-reduced seed proteins in cultivars from the two investigated crops besides intermediary 11S subunits (M_r about 60 kDa), contained oligomeric legumins - protein components with M_r (kDa) 87, 93, 114 and above. Oligomeric legumins were observed only in a few other dicotyledonous plants. Similarly to intermediary 11S subunits, after reduction with 2-mercaptoethanol they dissociated into acidic and basic polypeptides.

Our previous investigation (Vladova et al., 2000) implied that electrophoretic spectra of pepper non-reduced seed storage proteins might be used for cultivar characterization and for assessment of F1 hybrid purity.

In conclusion, the results obtained present opportunities for further investigation of oligomeric legumins and for their use in the genetic studies of pepper and eggplant cultivars.

References

- Derbyshire D., Wright L. and Boulter D., 1976. Legumin and vicilin storage proteins of legumin seeds. *Phytochemistry*, 15: 3-24.
- Laemmli K., 1970. Cleavage of structural proteins during the assembly of head of bacteriophage T4. *Nature*, 227: 680-685.
- Reisfeld R. A., Lewis J. A. and Williams D. E., 1962. Disk electrophoresis of basic proteins and peptides on polyacrylamide gels. *Nature*, 195: 281-283.
- Shewry P. R., Napier J. A. and Tatham A. S., 1995. Seed storage proteins: structure and biosynthesis. *The Plant Cell*, 7: 945-956.
- Vladova R., Pandeva R., Petcolicheva K., 2000. Seed storage proteins in *Capsicum annuum* L. cultivars, *Biol. Plant.*, 43: 291-295.

DISEASES AND RESISTANCE

New genes related to PVY resistance in *C. annuum* L. ‘Serrano Criollo de Morelos-334’

M.S. Arnedo Andrés, M. Luis Arteaga and R. Gil Ortega

Centro de Investigación y Tecnología Agraria de Aragón, C.I.T.A-D.G.A. Apdo. 727. 50080 Zaragoza, Spain. Contact: marnedo@aragob.es, Tel +31.976.716316

Abstract *C. annuum* L. ‘Serrano Criollo de Morelos-334’ (SCM-334) has been well studied as a source of several resistances against fungal and viral diseases. At the moment three genes have been reported in this line related to its resistance against Potato Virus Y (PVY). In this work, using ‘SCM-334’ derived lines, two new types of resistance are presented. The first one is a monogenic and recessive *locus*, controlling an specific-isolate resistance, and named as *pvr8*. The second one, is related to the inheritance of systemic necrotic symptoms after PVY inoculation. In this case a codominant gene is proposed and expressed only when *Pvr4* is not present.

Keywords: *Capsicum*, Potato Virus Y, Resistance, Necrosis

Introduction

C. annuum L. ‘Serrano Criollo de Morelos-334’ (SCM-334) is a pepper variety originally from Mexico and initially selected due to its high level of resistance against *Phytophthora capsici* Leon fungus (Guerrero-Moreno and Laborde, 1980). Lately, several resistance genes against potyviruses have also been described in this line. *Pvr4* produces a monogenic and dominant resistance against all the PVY pathotypes described until the moment (Dogimont et al., 1996 and Arnedo-Andrés et al., 1998) and also effective against PepMoV. Another *locus*, named as *pvr5*, was identified conferring a monogenic and recessive resistance against PVY isolates included in the pathotype 0 (Dogimont et al., 1996).

Systemic necrotic symptoms located on the leave veins, stem and apex have been observed on the variety ‘SCM-334’ after PVY inoculations and in some cases they could even produce the plant death. Pasko et al. 1992 described them on several ‘SCM-334’ derived lines. Lately, Dogimont et al. 1996, observed these type of symptoms in dihaploid lines obtained from ‘SCM-334’ x ‘Yolo Wonder’ crosses after inoculations with PVY-0 and 1-2 isolates. They suggested a monogenic dominant gene, *Pn1*, controlling the necrotic response and allelic to the gene present on the variety ‘Vat’. In other studies, were crosses between ‘SCM-334’ and the susceptible cultivar ‘Magda’ were inoculated with PVY, no systemic necrotic symptoms were reported (Boiteux et al., 1996).

In this work, two strategies using the ‘SCM-334’ line have been followed. Firstly several lines derived by intraselection from ‘SCM-334’ were tested by mechanical inoculation with several PVY isolates belonging to different PVY pathotypes, to study if some other resistance genes against PVY were present, besides *Pvr4* and *pvr5*. Therefore, some of those lines with an especial behavior after inoculation were crossed with several pepper varieties carrying different resistance levels against PVY to study the inheritance of them.

Material and methods

Plant material

The following species were used as differential hosts for PVY and were included in every inoculation: *Vigna unguiculata* L. Walp., *Nicotiana tabacum* L. 'Xanthi nc', *Nicotiana sylvestris* Speg. et Comes, *Nicotiana glutinosa* L., *Cucurbita pepo* L. 'Diamante F1', *Cucumis sativus* L. 'Marketer', *Chenopodium quinoa* Willd., *Ch. amaranticolor* Coste & Reyn, *Datura stramonium* L., *Physalis floridana* Rybd., *Petunia hybrida* Vilm and *Ocimum basilicum* L.

Six pepper cultivars; belonging to *Capsicum annuum* L.: 'Doux des Landes', 'Yolo Wonder', 'Yolo Y', 'Florida VR2', 'Puerto Rico Wonder' and 'Serrano Veracruz' were sown and inoculated to classify the PVY isolates within pathotypes.

Two lines, A97011 and A2.092, derived by intraselection from 'SCM-334' were used in this study. The A97011 line was selected as susceptible against all the PVY described pathotypes, with the exception of P-62-81 isolate, belonging to PVY pathotype 1, but unable to infect *Nicotiana glutinosa* L.. This line was selfed several cycles, crossed with 'Yolo Wonder', 'Yolo Y' and 'Florida VR2' and then inoculated with PVY isolates belonging to pathotypes 0, 1 and the atypical isolate P-62-81. On the other hand, line A2.092 was selected because it showed systemic necrotic symptoms after inoculations with some PVY isolates, and without carrying the *Pvr4* resistance gene. For the study of the inheritance of the systemic necrotic symptoms the 'SCM-334'(11) line, carrying the *Pvr4* resistance gene was crossed with 'Yolo Wonder'. The F₁, F₂, their backcrosses and 24 F₃ families originated from the F₂ susceptible plants were produced and inoculated with PVY-1-2.

Virus isolates and inoculation procedure

Five PVY isolates, coming originally from natural infected pepper plants, except PVY-1-3, were used for this study. P-27-81 representing the pathotype 0; P-27-86 and P-62-81 as isolates of pathotype 1, P-22-88 classified as PVY-1-2 and P-22-88 derived from experimentally infected 'Puerto Rico Wonder' as PVY-1-3.

Viruses were mechanically inoculated by rubbing (Marrou, 1967). Plants were inoculated in juvenile and in adult stages, and besides the symptoms observation, plants were assessed by ELISA test, using a monoclonal antiserum (Ingenasa, Spain).

Results

Reactions of the differential host plants, with all the isolates indicated that inoculations contained exclusively PVY viruses. The inoculated plants were also tested by ELISA tests and the results confirmed the symptomatology.

The 'SCM-334' line A97011 was selfed several cycles and the obtained material was inoculated with three isolates belonging to the PVY pathotypes 0 and 1, including the atypical PVY-1 isolate P-62-81. At the same time, several crosses between derived material from A97011 and the pepper varieties, Yolo Wonder, Yolo Y and Florida VR2 were also inoculated with the same isolates. All the plants inoculated with isolates P-27-81 (PVY-0) and P-27-86 (PVY-1) resulted susceptible.

The plant material inoculated with the P-62-81 isolate (PVY-1) showed different results, depending on genotypes. While the selfed material derived from A97011 was resistant, all the F₁ crosses with the other pepper genotypes resulted susceptible. Some advanced generations were also inoculated with P-62-81 to obtain further results. An F₂ with 127 plants obtained from the cross between A97011 x Yolo Wonder and two backcrosses with 30 and 74 plants each one, were also tested. All these data are summarized on Table 1. Within the F₂ population, resistant and susceptible plants

occurred. When using the χ^2 test with these data, the one recessive gene hypothesis was tested, and it was accepted ($P=0.33$). The results obtained with both backcrosses confirmed this hypothesis, when all the $BC_1(A97011 \times \text{Yolo W.}) \times \text{YW}$ were susceptible, while the $BC_1(A97011 \times \text{Yolo W.}) \times A97011$ produced 43 susceptible and 31 resistant plants.

Table 1. Results of the inoculations with three PVY isolates of several crosses between A97011 and some pepper varieties.

Plant material	PVY isolates		
	P-27-81 (PVY-0)	P-27-86 (PVY-1)	P-62-81 (PVY-1)
A97011	(9) ^a S	(6) S	(6) R
A97011 x Yolo W.	(21) S	(11) S	(9) S
A97011 x Yolo Y	(6) S	(8) S	(4) S
A97011 x Florida VR2	(6) S	(5) S	(5) S
F ₂ (A97011 x YW.)	N. T.	N. T.	(100) S (27) R
BC ₁ (A97011 x Yolo W.) x YW	N. T.	N. T.	(30) S
BC ₁ (A97011 x Yolo W.) x A97011	N. T.	N. T.	(43) S (31) R

^a: number of inoculated plants; S: susceptible; R: resistant; N.T.: no tested

With respect to the A2.092 line, plants belonging to this selection only developed systemic necrotic symptoms after inoculation with PVY pathotypes 1-2 and 1-3. The appearance of symptoms began with small necrotic lesions on inoculated leaves and it continued with vein and apical necrosis, up to ten days after inoculation. Occasionally necrotic spots on the stem appeared, which evolved to necrotic stems. Most of these plants died two weeks after inoculations. On the other hand, the symptoms observed when A2.092 plants were inoculated with PVY pathotypes 0 and 1, were the typical vein banding mosaic as systemic and occasionally, small necrotic lesions on inoculated leaves.

The following experiment involved the study of the inheritance of the systemic necrotic symptoms on SCM-334. Based on the previous results, the P-22-88 (PVY-1-2) isolate was chosen for this study. The parental lines inoculated showed the expected results. SCM-334 plants developed small local necrotic lesions on inoculated leaves and none of those plants showed any systemic symptoms. On the other hand, the parental line Yolo Wonder showed vein banding mosaic. The inoculated F₁ plants did not show any systemic symptoms, although most of them developed local necrotic lesions as observed in SCM-334. After inoculating the BC₁, F₂ and F₃ corresponding plants, and within the confirmed susceptible plants, three types of symptoms were observed. Within 10 to 15 days post-inoculation, some plants developed systemic necrotic symptoms, beginning with vein necrosis, followed by necrotic spots on the stem and apical necrosis and mostly causing the plants death. Another susceptible group of plants, started 10 to 15 days after inoculation with vein clearing followed by vein banding mosaic, mainly on the intermediate leaves. Finally, a group of plants developed both types of systemic symptoms. First of all, vein clearing was observed, and then, systemic mosaic was developed on some of the uninoculated leaves. At the same time, over other leaves, necrotic veins appeared, although their development was slower and less stronger compared to the other group of susceptible plants showing only systemic necrotic symptoms. Within this last group none of the plants died. The F₂ (Yolo Wonder x SCM-334) segregated according with a 1:1:2 ratio and the BC₁ with a 0:1:1 ratio for a necrotic :

mosaic : necrotic+mosaic response. Finally, when 24 F₃ families, with 25 plants each, derived from the PVY susceptible F₂ plants (Yolo Wonder x SCM-334) were inoculated the following results were observed: 7 families showed all plants with systemic necrosis, 4 families only showed systemic mosaic and 13 families showed both systemic symptoms. These results are summarized on Table 2.

Table 2: Segregation data of ‘SCM-334’(11), ‘Yolo Wonder’ and their progenies for the appearance of systemic necrotic symptoms after inoculation with the PVY-1-2 isolate P-22-88

<i>Genotype</i>	<i>Necrosis</i>	<i>Mosaic</i>	<i>Necrosis + Mosaic</i>	<i>No symptoms</i>	<i>Expected frequency</i> * (χ^2)
<i>SCM-334 (11)</i>	0	0	0	19	0:0:0:1
<i>Yolo Wonder</i>	0	20	0	0	0:1:0:0
<i>F₁ (SCM-334 x YW)</i>	0	0	0	20	0:0:0:1
<i>F₁ (YW x SCM-334)</i>	0	0	0	20	0:0:0:1
<i>BC₁ YW x (SCM-334 x YW)</i>	0	3	4	5	0:1:1:2 (0.50)
<i>F₂ (YW x SCM-334)</i>	8	10	21	124	1:1:2:12 (0.52)
<i>F₃ (SCM-334 x YW)</i>	7 families	4 families	13 families		1:1:2** (0.92)

*: expected frequency: necrosis : mosaic : necrosis + mosaic : no symptoms; **: only the progeny from the susceptible F₂ plants were taken into account.

Discussion

Pasko et al. 1992, already described several levels of resistance in ‘SCM-334’ against the different PVY pathotypes, and it allowed to derived some ‘SCM-334’ lines, some of them used in this study. Dogimont et al. 1996 defined *Pvr4* and *pvr5* as the resistance genes in ‘SCM-334’ and responsible of its PVY resistance. The results obtained in this study, concerning the A97011 lines and their crosses with several pepper genotypes suggested other level of resistance against PVY. This resistance might be controlled by a unique, recessive and independent gene of the *pvr2* locus. At the moment and according to the latest nomenclature for resistance genes in *Capsicum* (Kyle and Palloix, 1997), this new locus is named as *pvr8*.

The appearance of systemic necrotic symptoms is known in the interaction between pepper and *Potyvirus*, and their genetic control is diverse. In this study we reported that their presence is dependent on the isolate inoculated, and in our case they appear after inoculation with the most virulent isolates, as PVY-1-2 and 1-3. Other studies (Dogimont et al. 1996) reported these kind of symptoms with isolates belonging to PVY pathotypes 0 and 1-2. In our opinion further studies including more isolates might be done to clarify this point.

The inheritance studies done in this work proposed the hypothesis that the genetic control for the appearance of systemic necrotic symptoms in SCM-334 after PVY inoculation is due to a codominant gene, expressed only when *Pvr4* is not present and whose maximum expression is observed in homozygous condition.

References

- Arnedo-Andrés M., Luis Arteaga M. y Gil Ortega R., 1998. Response of 'Serrano Criollo de Morelos-334' to PVY pathotypes. X EUCARPIA Meeting on Genetics and Breeding on *Capsicum* & Eggplant, Avignon (Francia), 7-11 Septiembre: 105-109.
- Boiteux L.S., Cupertino F.P., Silva C., Dusi A.N., Monte-Nesich D.C., Van der Vlugt R.A.A. y Fonseca M.E.N., 1996. Resistance to potato virus Y (pathotype 1-2) in *Capsicum annuum* and *Capsicum chinense* is controlled by two independent major genes. *Euphytica*, 87: 53-58.
- Dogimont C, Palloix A, Daubeze AM, Marchoux G Gebre-Selassie KE. and Pochard E (1996) Genetic analysis of broad spectrum resistance to potyviruses in haplodiploid progenies of pepper (*Capsicum annuum* L.). *Euphytica* 88: 231-239.
- Guerrero-Moreno A. y Laborde J.A., 1980. Current status of pepper breeding for resistance to *Phytophthora capsici* in Mexico. IV EUCARPIA Meeting on Genetics and Breeding on *Capsicum* & Eggplant, Wageningen (Países Bajos), 14-16 Octubre: 52-56.
- Kyle MM and Palloix A (1997) Proposed revision of nomenclature for potyvirus resistance genes in *Capsicum*. *Euphytica* 97: 183-188
- Marrou J., 1967. Amélioration des méthodes de transmission mécanique des virus par adsoption des inhibiteurs d'infection sur charbon végétal. C.R. Academie Agricole France, 53: 972-981.
- Pasko P., Luis Arteaga M. y Gil Ortega R., 1992. Different kinds of reactions to PVY-1-2 in *Capsicum annuum* L. cv 'SCM-334'. VIII EUCARPIA Meeting on Genetics and Breeding on *Capsicum* and Eggplant. Rome (Italia), 7-10 Septiembre:153-156.

PVY evolution toward virulence to the resistance conferred by *pvr2*³ in pepper and consequences for its durability

Valérie Ayme^{1,2}, Olivier Pierrugues¹, Sylvie Souche¹, Ghislaine Nemouchi², Carole Caranta², Mireille Jacquemond¹, Joël Chadoeuf³, Alain Palloix², Benoît Moury¹

¹I.N.R.A., Station de Pathologie Végétale, F-84143 Montfavet Cedex, France

²I.N.R.A., Génétique et Amélioration des Fruits et Légumes, BP 94, 84143 Montfavet Cedex, France

³I.N.R.A., Unité de Biométrie et Intelligence Artificielle, site Agroparc, 84914 Avignon Cedex, France

contact: valerie.ayme@avignon.inra.fr

Abstract : *pvr2*¹ and *pvr2*² are recessive resistance alleles conferring a total resistance to *Potato virus Y* (PVY, genus *Potyvirus*) in pepper (*Capsicum* spp). In addition, a polygenic resistance to PVY was also characterised. This resistance results from a combination of a major-effect gene at the *pvr2* locus, called *pvr2*³, and several minor-effect QTLs. Alleles at the *pvr2* locus were shown to correspond to the eukaryotic translation initiation factor 4E (eIF4E). Infectious cDNA clones of several PVY strains and chimeras between them were used to identify PVY virulence determinants related to resistance alleles at the *pvr2* locus. Exchange of the central part of the VPg-coding region between the cDNAs of two PVY strains changed their virulence toward *pvr2*¹ and *pvr2*². Similar experiments demonstrate that the VPg of PVY is also a virulence determinant toward *pvr2*³. Introducing substitutions from the VPg of a virulent PVY strain into two different cDNA clones of PVY conferred virulence toward *pvr2*³, whatever their virulence toward *pvr2*¹ and *pvr2*². Inoculation of *pvr2*³ pepper plants with a virus inoculum obtained from the cDNA clones of an avirulent PVY strain showed a particularly high frequency of overcoming (40 to 80% of inoculated plants). The VPg coding-region from 16 of these plants differed by a single nucleotide (and by a single amino acid) from the original PVY clone. Six different amino acid substitutions were detected and were shown to be independently responsible for virulence towards *pvr2*³. These six substitutions appeared with significantly different frequencies, one of them being overrepresented. The frequencies correlated well however with maximum likelihood estimates of relative substitution frequencies for PVY.

Keywords: resistance breaking, potyvirus, mutation, evolution, durability.

Introduction

One of the common features of RNA viruses is a high mutation rate, which is attributed mostly to the lack of proofreading ability of RNA-dependent RNA polymerase (RdRp) (Drake and Holland, 1999). It has been postulated that the genetic heterogeneity between the different viruses is advantageous to virus survival, since the simultaneous presence of multiple variant genomes allows rapid selection of mutants better suited to new environments (Domingo and Holland, 1997; Domingo et al., 2001). The demonstration that a molecularly cloned genome of a plant RNA virus can evolve experimentally to overcome a resistance supports the notion that RdRp errors together with large population size and short generation times coupled with selection pressure is one of the mechanisms responsible for emergence of such viral mutants in plants.

Resistance breaking virus isolates are known for most plant resistance genes. The viral features involved in resistance can therefore be identified by comparison of the resistance breaking and avirulent forms of the virus, and the key differences verified by reverse genetics. Comparable studies with different resistance genes (both dominant and recessive) in a range of plant species identified many viral genes as the cognate avirulence or virulence factor. For example, for potyviruses and concerning monogenic recessive resistances, the VPg (Virus Protein genome-linked) coding-region is frequently

a virulence determinant (Nicolas et al. 1997, Keller et al. 1998, Borgström and Hansen 2001, Moury et al. 2004) whereas mutations in the region encoding P3 and 6K1 coding-regions determine virulence of PSbMV to the *sbm-2 gene in pea* (Johansen et al. 2001).

The vast majority of these resistance-breaking variants has no selective advantage over the original strain, and is counter-selected when the selection pressure exerted by the host resistance gene stops. This is often referred to as “virulence costs”. These losses of biological fitness can be caused by many factors, ranging from decreased replication rate to loss of ability to infect a given plant species. Due to the limited genome size of viruses, each of their proteins often display multiple functions. It is therefore highly possible that mutations involved in resistance overcoming also affect other viral functions essential for infection cycle and are responsible for so-called “virulence costs”.

In pepper (*Capsicum spp.*), an allelic series at the *pvr2* locus controls the recessive resistance to PVY (Kyle and Palloix, 1997). The pathotype 0 of PVY infects only peppers carrying the susceptible allele (*pvr2*⁺), the pathotype 0,1 infects also peppers carrying the *pvr2*¹ allele and the pathotype 0,1,2 infects peppers with the *pvr2*² allele (Gebre Selassie et al. 1985). In addition, a polygenic resistance to PVY from the cultivar Perennial was dissected into a combination of QTLs including a major-effect gene that was mapped at the *pvr2* locus (Caranta et al. 1997). All *pvr2* alleles were further shown to correspond to the eukaryotic translation initiation factor 4E (eIF4E) (Ruffel et al., 2002), and we propose to name *pvr2*³ the major-effect gene at the *pvr2* locus.

Infectious cDNA clones of two PVY strains and chimeras between them were used to identify PVY virulence determinants toward the *pvr2*¹ and *pvr2*² alleles. Exchange of the central part of the VPg-coding region between the cDNAs of two PVY strains changed their virulence toward *pvr2*¹ and *pvr2*². Sequence analysis showed that five amino acid changes control the virulence of PVY toward these resistance alleles (Moury et al., 2004).

In this article we show that a PVY clone avirulent to *pvr2*³ can overcome extremely efficiently and rapidly the resistance conferred by this allele. Multiple mutations in the VPg coding-region were independently responsible for PVY virulence toward *pvr2*³. Implication of these results for resistance durability are discussed.

Material and methods

Virus strains and clones, and plant genotypes

PVY isolates LYE84.2 and SON41 have been described by Gebre Selassie et al. (1985) and Morel et al. (2000), respectively. Isolate LYE84.2 does not infect pepper plants homozygous for *pvr2*¹, *pvr2*² or *pvr2*³ alleles. Isolate SON41 was separately maintained in two different laboratories leading to SON41p and SON41g. Both of them infect plants homozygous for *pvr2*¹ or *pvr2*² but *pvr2*³/*pvr2*³ plants are infected by SON41g only. Full-length cDNA clones of isolates LYE84.2 and SON41p have been previously obtained (Moury et al., 2004).

Yolo Wonder is a bell pepper inbred line susceptible to PVY (*pvr2*⁺/*pvr2*⁺). HD285 is a doubled-haploid line derived from the F₁ hybrid [Perennial x Yolo Wonder] that carries susceptibility allele at all the PVY resistance QTLs identified (Caranta et al. 1997) but possesses the resistance allele *pvr2*³.

Virus inoculation and detection

Viruses were propagated in *Nicotiana spp.* to obtain high-titer inoculum for tests on *C. annuum*. Leaf tissue from infected *Nicotiana spp.* plants developing severe symptoms of the disease was homogenised in four volumes of 0.03 M phosphate buffer (pH 7.0) supplemented with 2% (w/v) diethyldithiocarbamate, 20 mg/mL of active charcoal and 20

mg/mL of Carborundum. Test plants with one expanded leaf were inoculated manually approximately two to three weeks after sowing.

Evaluation of virus infections was performed by double-antibody sandwich-enzyme-linked immunosorbent assay (DAS-ELISA) as described by Legnani et al. (1995) at various timepoints after inoculation.

Total RNAs from systemically-infected leaves (purified with the Tri Reagent kit, Molecular Research Center Inc., Cincinnati, USA) were used for reverse transcription-polymerase chain reaction (RT-PCR) with *Avian myeloblastosis virus* reverse transcriptase (Promega, Madison, USA) *Taq* DNA polymerase (Promega) and specific primers covering the entire VPg coding-region (Moury et al., 2004).

Cloning of PVY infectious clones and chimeras

The recombinant clone LYE84.2xVPgSON41g was performed using the protocol described by Moury and associates (2004). All other cloning experiments were performed using homologous recombination in the yeast strain YPH of *Saccharomyces cerevisiae*. A plasmid vector containing cassette for replication and selection both in *S. cerevisiae* and *Escherichia coli* and the full-length cDNA clone of SON41p strain under the control of the 35S promoter was constructed. The internal part of the VPg coding-region in this clone was deleted and replaced by a short DNA sequence containing a unique *NotI* restriction site. Transformation of yeast was performed with the deleted plasmid linearized by a *NotI* digestion as a vector and RT-PCR products of the entire VPg coding-region containing single nucleotide (and amino acid) change in comparison to the sequence of SON41p as inserts. This strategy was also used to create the chimera SON41pxVPgSON41g where four nucleotides (and amino acids) substitutions in a RT-PCR product covering the VPg coding-region of the isolate SON41g were introduced into the SON41p clone.

Primary inoculations with these cDNA clones were made by tungsten particle bombardments of *N. benthamiana* or *N. clevelandii* plants as described in Moury and associates (2004).

Analysis of the mutation rates and estimation of relative substitution frequencies

PAML (Yang, 1997) is a package of programs that can be used to analyse RNA sequence evolution using maximum likelihood methods. The program baseml was used to estimate relative substitution frequencies during the evolution of PVY genome based on sequences of the P1 protein, the VPg and the Coat protein available in databanks.

Statistical analyses

Statistical analyses were performed with R software (Ihaka and Gentleman, 1996). Due to the small number of mutants, we preferred to analyse the distribution of the different virulent mutants by using a Monte Carlo simulation method instead of a classical χ^2 test. Monte Carlo method allows to obtain exact confidence intervals for small sample (Manly, 1997). 100 000 Monte Carlo simulations were performed under two different hypotheses: H0: all of six mutants appeared with the same probability, H1: the six mutants appeared with probabilities proportional to the corresponding relative substitution rates estimated with PAML.

Results

Detection of PVY in susceptible and resistant *C. annuum* genotypes

The reactions of *C. annuum* genotypes to inoculations with various PVY isolates representing different pathotypes are described in Table 1. Systemically infected plants showed mosaic or necrotic symptoms in apical, noninoculated leaves, and exhibited high

DAS-ELISA values. No systemic infections were observed and no virus coat protein was detected by DAS-ELISA in inoculated or apical leaves in resistant plants-avirulent PVY isolate combinations.

The central region of the PVY VPg-coding region determine virulence toward $pvr2^3$ allele

Variations in the VPg region of PVY are responsible for virulence toward $pvr2^1$ and $pvr2^2$ alleles. To test whether the VPg region of PVY is also involved in virulence toward $pvr2^3$ allele, the infectivity of the chimeras LYE84.2xVPgSON41g and SON41pxVPgSON41g were compared with that of LYE84.2, SON41p and SON41g by inoculation of the *C. annuum* genotypes. The chimeras LYE84.2xVPgSON41g and SON41pxVPgSON41g infected the genotype possessing the $pvr2^3$ allele systematically, as did the isolate SON41g, whereas the isolates SON41p and LYE84.2 infected only Yolo Wonder (Table 1). This demonstrated that the central part of the VPg coding-region possesses the genetic determinant for virulence toward $pvr2^3$ allele.

Table 1: Infectivity of PVY strains in *Capsicum annuum*.

Genotypes	Yolo Wonder	HD285
<i>Alleles at resistance locus</i>	$pvr2^+ / pvr2^+$	$pvr2^3 / pvr2^3$
PVY isolates^a		
<u>SON41p</u>	S ^b	R ^c
<u>SON41g</u>	S ^b	S ^b
<u>LYE84.2</u>	S ^b	R ^b
<u>LYE84.2x VPgSON41g</u>	S ^b	S ^b
<u>SON41px VPgSON41g</u>	S ^b	S ^b

^a Inoculum prepared from PVY cDNA clones are underlined.

^b S: susceptibility (plants showed mosaic or necrosis symptoms and leaf extracts exhibited high absorbance values by DAS-ELISA); R: resistance (no symptom and no PVY detection in inoculated or apical leaves by DAS-ELISA).

^c A proportion of the plants were infected due to the evolution of the virus (see further)

Selection of PVY virulent variants by $pvr2^3/pvr2^3$ pepper genotypes

During all experiments where HD285 ($pvr2^3/pvr2^3$) pepper plants were inoculated with PVY inoculum derived from the SON41p cDNA clone, a proportion (36.7%) of plants showed late systemic symptoms (32 to 68 dpi) (Table 2). When virus extracts from these plants were backinoculated to HD285, 100% of these plants were systemically infected as rapidly as control plants inoculated with SON41g (10-14 dpi). This suggests drastic changes in the virulence properties of the virus population probably due to accumulation of virulent mutants.

Total RNA was extracted from apical leaves of 16 infected HD285 plants obtained during different experiments. RT-PCR products with these RNA extracts were directly sequenced. In each sequence, a single nucleotide corresponding to a single amino acid substitution differed from the original sequence of SON41p. Six distinct mutations were observed and their occurrence is reported in table 2.

Table 2 : Number of HD285 (*pvr2³/pvr2³*) pepper plants infected after inoculation with PVY strain SON41p and amino acid variations in the VPg of the resistance-breaking virus populations.

Test	test condition and inoculation method	Infected/inoculated plants	Date of symptoms appearance	Number of mutant sequenced ^a					
				Ser101Gly	Thr115Lys	Thr115Arg	Asp119Asn	Asp119Glu	Ser120Cys
1	Greenhouse	8/20	32-68	2	1		3		1
2	climatic room	2/20	41				1	1	
3	climatic room	5/15	21-38			1	3		1
4	greenhouse	4/10	32-50						
5	graft-inoculation	10/14	39-53		1		1		
6	aphid transmission	25/104	25-35						
	TOTAL	29/79		2	2	1	8	1	2

^a the first amino acid corresponds to the sequence of SON41p, the number to the position in the PVY VPg and the second amino acid to the virulent mutant sequence.

Six different mutations in the central part of the VPg coding-region of PVY independently determine virulence toward *pvr2³* allele

The role of the six mutations observed in breaking down the *pvr2³*-mediated resistance was tested by introducing separately these six mutations into the full-length cDNA clone of SON41p. Systemic infections were observed in *pvr2³/pvr2³* plants 10-14 days after inoculation with each of the six mutated clones, but not for the original SON41p clone. VPg sequences were controlled after the test and proved to be identical to the sequence of the corresponding cDNA clones. This demonstrated that at least six nucleotide (and amino acid) changes in the VPg independently conferred virulence toward the resistance due to *pvr2³*.

The frequencies of appearance of the different virulent mutants correlate with estimates of relative substitution rates during PVY evolution

In our experiment, the Asp119Asn mutant appeared more frequently than the other five mutants (half of the 16 virus populations sequenced). However, the total number of sequences was relatively low. Hence, we tested whether the six mutants appeared with significantly different frequencies using Monte Carlo simulations. The frequency of the Asp119Asn is above the upper limit of the 95 or of the 99% confidence interval of 100 000 Monte Carlo simulations under the hypothesis that all six mutants appeared with identical frequencies (Fig.1). The differences in the frequencies of appearance of the mutants could be a consequence of the relative substitution rates of the virus, the Asp119Asn and Ser101Gly are transitions whereas others substitutions are transversions (which are expected to be less frequent). Another hypothesis is that mutant Asp119Asn

has a high fitness (level of accumulation in a plant devoid of resistance) than the other five mutants and is therefore more frequently selected in *pvr2³/pvr2³* plants.

To estimate the relative substitution rates during PVY evolution, we analysed nucleotide sequences corresponding to PVY proteins P1, VPg and CP available in databanks. Sequence alignments and trees were constructed and analysed separately with the baseml program of the PAML software (Yang, 1997) for these three sets of sequences. We consequently obtained estimates for the rates of the 12 different types of substitutions in the PVY genome during its evolution. Estimates obtained with the P1, VPg and CP coding-regions differed only slightly.

Fig 1: Number of occurrence of each virulent mutant. The six mutants observed during our experiments are represented by black dots. Monte Carlo simulations were performed under two hypotheses: H0: the six mutants have equal probabilities of appearance; H1: the six mutants have probabilities of appearance proportional to the corresponding substitution rates estimated with PAML.

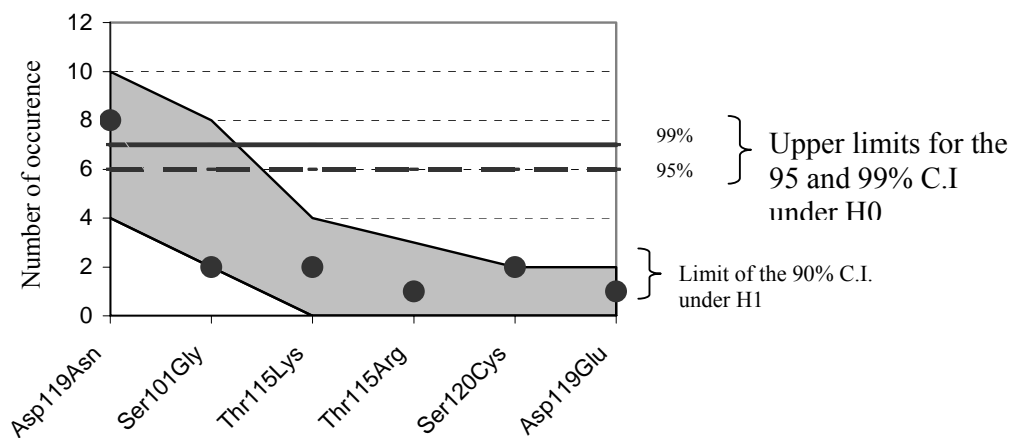

The frequencies appearance of the different mutants are located within the 90% confidence interval of the Monte Carlo simulations (Fig. 1). Consequently, the relative frequencies of the different mutants correlates well with estimates of their relative substitutions.

Conclusion and perspectives

Resistance durability is related to two factors : (i) the frequency of appearance of virulent variants in the plants, which is a consequence of the mutation accumulation during virus multiplication, and (ii) the relative fitness of the virulent variants which is usually measured in susceptible plants (Leach et al., 2001). These factors should be considered in the future for predicting the durability of a resistance as early as possible in the lifetime of a cultivar carrying a newly introgressed resistance trait (Lecoq et al., 2003).

There is a general trend to an increase in durability of resistance when many mutations are needed to gain virulence. When two or more mutations in the genome are needed to overcome a resistance, durability of the resistance is usually satisfactory. When only one mutation suffices to break resistance, this resistance is generally poorly durable (Harrison, 2002).

In the extreme case reported here, not only a single point mutation in PVY VPg is sufficient to overcome the resistance due to *pvr2³*, but six different substitutions can independently confer virulence. The resistance conferred by the *pvr2³* allele is easily

broken down which is related to rapid selection of adapted virulent variants present in the inoculum. Our results showed a good correlation between the estimated rates of substitutions leading to six virulent mutants and their frequencies of appearance during our experiments.

If the fitness cost conferred by resistance breaking is high, virulent variants may not be able to persist in virus populations, and a resistance apparently easily overcome in greenhouse conditions might prove to be durable in the field (Garcia-Arenal et al., 2003).

This study was obtained with a doubled-haploid line that possesses the resistance allele *pvr2*³ in a susceptible genetic background. However, the polygenic resistance from Perennial proved to be much more difficult to overcome and displayed a complete resistance to SON41g (Caranta et al 1997). This is probably due to the additional “minor effect” QTLs. A polygenic resistance can confer a high level of resistance by their combined forces, the adaptation of a pathogen to render each gene involved in polygenic resistance ineffective is theoretically more complex than to render just one gene ineffective in case of monogenic resistance (Lindhout, 2002). Future work should focus on the effect of minor QTLs on the virus variation and the fitness of the different variants.

References

- Borgström, B. and Johansen, I.E. 2001: Mutations in Pea seedborne mosaic virus genome-linked protein VPg alter pathotype-specific virulence in *Pisum sativum*. *Mol. Plant-Microbe Interact.* 14 : 707-714.
- Caranta, C., Lefebvre, V. and Palloix, A. 1997 : Mapping polygenic resistance to potyviruses in pepper : identification of specific and new broad spectrum resistance factors with quantitative effects. *Mol. Plant-Microbe Interact.* 10 : 872-878.
- Domingo, E. and Holland, J.J. 1997 : RNA virus mutations and fitness for survival. *Annu Rev Microbiol* 51 : 151–178
- Domingo, E., Biebricher, C.K., Eigen, M., Holland, J.J., 2001: Quasispecies and RNA virus evolution: Principles and consequences. Landes Bioscience, Georgetown, TX.
- Drake, J.W. and Holland, J.J. 1999 : Mutation rates among RNA viruses. *Proc. Natl. Acad. Sci. USA* 96 : 13910–13913
- Garcia-Arenal, F. and McDonald, B. 2003 : An analysis of the durability of resistance of plant to viruses. *Phytopathology* 93 : 941–952
- Gebre Selassie, K., Marchoux, G., Delecolle, B., and Pochard, E. 1985 : Variabilité naturelle des souches du virus Y de la pomme de terre dans les cultures de piment du sud-est de la France. *Caractérisation et classification en pathotypes. Agronomie* 5 : 621-630.
- Harrison, B.D. 2002 : Virus variation in relation to resistance breaking in plants. *Euphytica* 124 : 181–192.
- Ihaka, R. and Gentleman, R. 1996 : R : a language for data analysis and graphics. *Journal of Computational and Graphical Statistics* 5 : 299-314.
- Johansen, I.E., Lund, O.S., Hjulsager, C.K., and Laursen, J. 2001 : Recessive resistance in *Pisum sativum* and potyvirus pathotype resolved in a gene-for-cistron correspondence between host and virus. *J. Virol.* 75 : 6609-6614.
- Keller, K.E., Johansen, I.E., Martin, R.R., and Hampton, R.O. 1998 : Potyvirus genome-linked protein (VPg) determines pea seed-borne mosaic virus pathotype-specific virulence in *Pisum sativum*. *Mol. Plant-Microbe Interact.* 11 : 124-130.
- Kyle, M.M., and Palloix, A. 1997 : Proposed revision of nomenclature for potyvirus resistance genes in *Capsicum*. *Euphytica* 97:183-188.
- Leach, J.E., Vera Cruz, C.M., Bai, J., Leung, H., 2001 : Pathogen fitness penalty as a predictor of durability of disease resistance genes. *Annu. Rev. Phytopathol.* Vol. 39: 187-224

- Lecoq, H., Moury, B., Desbiez, C., Palloix, A., Pitrat, M., 2004 : Durable virus resistance in plants through conventional approaches : a challenge. *Virus Research*. Article in press.
- Legnani, R., Gebré Selassié, K., Nono Wondim, R., Gognalons, P., Moretti, A., Laterrot, H. and Marchoux, G. 1995 : Evaluation and inheritance of the *Lycopersicon hirsutum* resistance against potato virus Y. *Euphytica* 86 : 219–226.
- Lindhout, P. 2002 : The perspectives of polygenic resistance in breeding for durable disease resistance. *Euphytica* 124 : 217-226.
- Manly B. F.J., 1997 : Randomization, bootstrap and Monte Carlo method in biology, second edition, Chapman & Hall Ed. London, 399p.
- Moury, B., Morel, C., Johansen, L., Guilbaud, L., Souche, S., Ayme, V., Caranta, C., Palloix, A., Jacquemond, M., 2004 : Mutations in Potato virus Y genome-linked protein determine virulence towards recessive resistances in *Capsicum annuum* and *Lycopersicon hirsutum*. *Mol. Plant-Microbe Interact.* 3 : 322-329.
- Morel, C., Gognalons, P., Guilbaud, L., Caranta, C., Gebre Selassie, K., Marchoux, G., and Jacquemond, M. 2000 : Biological and molecular characterization of two tomato strains of potato virus Y. *Acta Physiologiae Plantarum* 22 : 336-343.
- Nicolas, O., Dunnington, S.W., Gotow, L.F., Pirone, T.P., and Hellmann, G.M. 1997 : Variations in the VPg protein allow a potyvirus to overcome *va* gene resistance in tobacco. *Virology* 237 : 452-459.
- Ruffel, S., Dussault, M.H., Palloix, A., Moury, B., Bendahmane, A., Robaglia, C., and Caranta, C. 2002 : A natural recessive resistance gene against potato virus Y in pepper corresponds to the eukaryotic initiation factor 4E (eIF4E). *Plant J.* 32:1067-1075.
- Yang, Z. 1997 : PAML: a program package for phylogenetic analysis by maximum likelihood. *Computer Applications in Biosciences* 13 : 555-556.

The unity of plant defense: Genetics, breeding and physiology

Gabor Csillery¹, Eszter Szarka², Eva Sardi², Judit Mityko³, Jozsef Kapitany⁴,
Barbara Nagy⁵, Janos Szarka⁶

¹ Budakert Ltd. H-1114 Budapest, Bartok B. u. 41. Hungary. Contact: g.csillery@freemail.hu, Tel/Fax+36-1-279-00-93, ² BUESPA, Fac. Hort. Sci., Dept. Gen. and Plant Breed. H-1118 Budapest Menesi u. 44. Hungary., ³ Agricultural Biotechnology Center, H-2101 Godollo, P.O.Box 411. Hungary., ⁴ Red Pepper Research-Development P.B.C., H-6300 Kalocsa, Obermayer ter 9. Hungary., ⁵ BUESPA, Fac. Food Sci., Central Laboratory H-1118 Budapest, Villanyi ut 35-43. Hungary., ⁶ Primordium Ltd. H-1222 Budapest, Fenyopinty u.7. Hungary.

Abstract: In addition to specific resistance genes coding hypersensitive reaction (HR), concomitant with fast cell destruction which is most frequently used in plant resistance breeding, there are general defense reactions (GDR), which are not pathogen specific and are aimed at preservation of the cells attacked by the pathogen by all means. The stimulus threshold of GDR is much lower than that of HR and its reaction speed is also higher. The biochemical backgrounds of the two defense reactions based on the two different strategies greatly differ from each other. On the basis of these features GDR is suitable to play the role of the plant immune system, while HR is to act as a specific defense excluding certain pathogens. In case of pepper, GDR is determined by *gds* gene of monogenic recessive hereditary course, while monogenic dominant *Bs-2* gene directs HR against *Xanthomonas vesicatoria* bacterium. Because of their functions, the interaction of the two genes does not result in the expected dominant-recessive relation. The general and specific defense reactions complementing each other constitute the unity of plant disease resistance.

Keywords: *Capsicum annuum*, *Xanthomonas vesicatoria*, resistance, Hypersensitive Reaction (HR), General Defense Reaction (GDR), general defense system (*gds*) gene, *TMV*, *TSWV*, *Meloidogyne*, glucose, formaldehyde, peroxidase enzyme

Introduction

Basic feature of all plants is aggressiveness to their environment, which at the same time defines the extent of their immunity against the stress of the environment.

Susceptible varieties of plants produced in course of selection, and then in increasingly conscious breeding period concentrating on size, appearance, abundance and other consumption criteria, neglecting disease resistance led to considerable epidemics. Discovery of hypersensitive reaction (Ward 1902, Stakman 1915) ensuring disease resistance of plants offered a way-out from this situation. Since this discovery, experts in the world working in this field, just like us, in course of our thirty-year resistance breeding work have been thinking mainly of susceptible and hypersensitive prognostic symptoms.

In course of resistance breeding against the main pathogens and pests of pepper the following monogenic resistance genes of dominant inheritance which react to infection with hypersensitive (HR) tissue destruction are used:

- against *Tobacco mosaic tobamovirus* (TMV, ToMV, PMMV) the alleles of *L* gene *L*¹, *L*², *L*³, *L*⁴ (Holmes 1937, Boukema 1980, Csillery & Rusko 1980, Boukema 1982),
- against *Tomato spotted wilt tospovirus* (TSWV) *Tsw* gene (Black et al. 1991),
- against *Xanthomonas vesicatoria* bacterium *Bs-1* (Cook & Stall 1963), *Bs-2* (Cook & Guevara 1984) and *Bs-3* genes (Kim & Dempsey 1977),

- against *Meloidogyne arenaria*, *M. incognita*, *M. javanica* root gall nematode *N* gene (Hare 1957, Fery & Dukes 1996), the *Me1*, *Me2*, *Me3*, *Me4* and *Me5* genes (Hendy et al. 1985).

These self-destructing specific defense reactions providing the last opportunity of defense for plants have any role in the evolution process only if they are inherited dominantly, which means they appear in all genotypes.

During the several-decade-long breeding based on specific resistance genes, from the beginning to our days, individuals reacting with hypersensitive tissue destruction the fastest are selected on the basis of prognostic symptoms appearing after artificial infection.

Is selection on the basis of the speed of hypersensitive reaction right?

Regarding the objectives of selection used in resistance breeding works based only on hypersensitive reaction, we have voiced doubts.

Our doubts have been confirmed by our observations that in the pepper – *X. vesicatoria*, host - pathogen relation, plants not containing specific resistance gene against *X. vesicatoria* bacterium also proved to be resistant during provocative infection. This reaction, contrary to hypersensitive reaction, excludes the pathogen attacking the plant by tissue compacting with cell enlargement and not by cell destruction. We called this defense reaction General Defense Reaction (GDR) on the basis of our pathophysiological research. According to our genetic tests, this reaction on pepper is regulated by monogenic recessive gene coming from *C. annuum* PI 163192 and we called it general defense system (*gds*) gene (Szarka & Csillery, 1995).

In our work, we examined the genetic and physiological backgrounds of two reactions based on fundamentally different strategies in blocking pathogens, appearing in cell destruction and tissue compacting by cell enlargement, and their relations to each other.

Material and methods

Plant material

C. annuum PI 163192 line, which is the source of *gds* gene and ECW-20 line which contains *Bs-2* gene have been used as basic materials in our work we began over 10 years ago. Resistant lines have been produced from the two lines by several back-crossings primarily in accordance with the needs of Hungarian outdoors production and following the last back-crossings almost isogene resistant and susceptible dihaploid (DH) lines have been produced from suitable phenotype lines on the basis of Dumas de Vaulx et al. method (1981).

- Hungarian spice pepper: long -shaped, green/red fruit.
- Hungarian waxy pepper: Cecei (conical) and Blocky-shaped, white/red and white/yellow fruit.
- Tomato-shaped and Blocky type: green/red and green/yellow fruit.

Following several back-crossings within all three phenotypes, hybrids were produced between the lines containing *gds* and *Bs-2* genes and currently we are examining those of F₁ and F₂ generations.

For the detailed genetic and physiological examinations DH lines susceptible to *X. vesicatoria* bacterium (DH-99-30, DH-99-71), DH lines containing *gds* resistance gene (DH-99-95, DH-99-269) and line containing *Bs-2* resistance gene (DH-99-487) have been used. Plants have been cultivated in 8-litre containers, in air-conditioned greenhouses (26 ± 3 °C) for the experiments.

Pathogen

Inoculation of 10^7 bacteria cell/ml concentration has been produced from 48 hour culture of *Xanthomonas vesicatoria* isolation of Hungarian origin.

Infection method

The inoculation was pressed in a 15 mm diameter patch with a syringe into the intercellular spaces of leaves. The prognostic symptoms were evaluated after 10-day incubation.

Electron microscopic examinations

The examinations and pictures were taken with TESLA BS-300 scanning instrument.

Biochemical examinations

To confirm the results obtained from the observations of prognostic symptoms, biochemical examinations were also performed on pepper plants containing *gds* gene which ensures high level general defense reaction (GDR), on susceptible (S) plants and on pepper plants containing specific resistance gene (*Bs-2*) causing hypersensitive tissue destruction (HR). Those compounds (glucose, peroxidase enzyme, methylated compounds, formaldehyde) were measured for 24 hours following inoculation, which indicate the impact of stress caused by *Xanthomonas vesicatoria* bacterium inoculation with their quantitative changes.

Results and discussion

Morphological and physiological features of processes, directed by *Bs-2* specific resistance gene causing hypersensitive (HR) cell destruction and *gds* gene excluding the pathogen without cell destruction, with general defense reaction (GDR) appearing in tissue thickening were examined in pepper – *X. vesicatoria*, host-pathogen relation.

In course of electron microscopic tests, cell destruction typical of hypersensitive reaction took place in the well-known way. In case of reaction without cell destruction, the inoculated tissues have thickened threefold compared to the control as a result of considerable cell division, cell enlargement (Figure 1.).

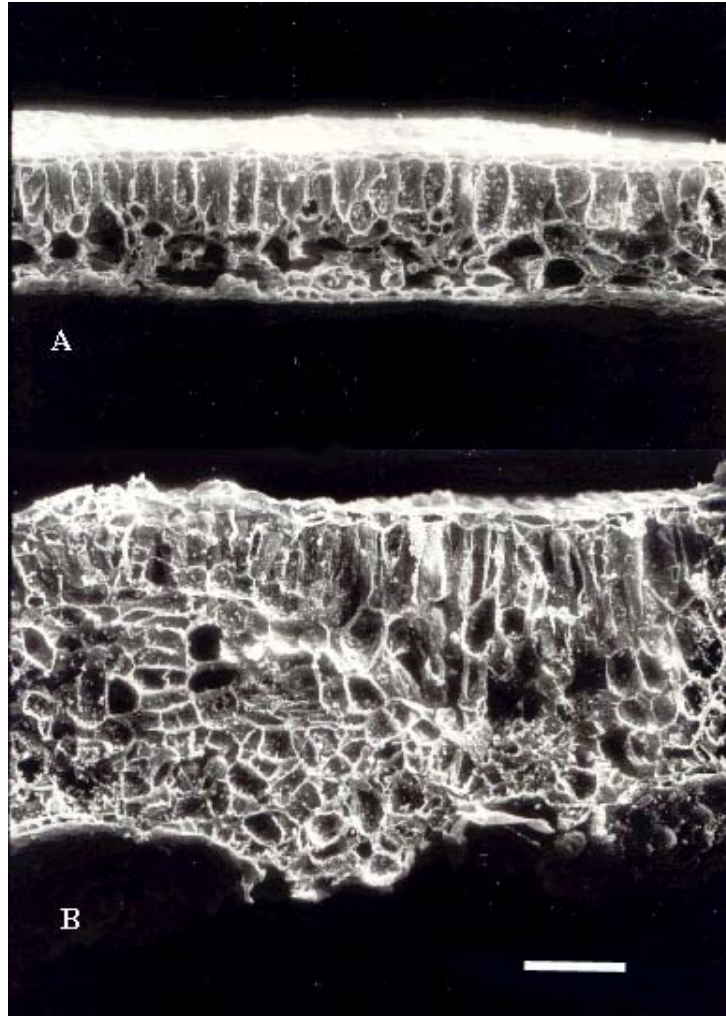

Figure 1. Cross section of pepper line leaf (DH-99-269), containing *gds* gene. Control (A) and *X. vesicatoria* inoculated leaf (B) with cell enlargement and proliferation. The bar approx. 100 μ m

Almost isogene lines (P1-P5) of identical fruit phenotype (white, blocky) were used for the detailed genetic examinations:

- P1 (DH-99-30), and P3 (DH-99-71) susceptible to *X. vesicatoria* bacterium
- P2 (DH-99-95) and P4 (DH-99-269) containing *gds* resistance gene
- P5 (DH-99-487) containing *Bs-2* resistance gene

Crossing P1, P3 DH lines highly susceptible to *X. vesicatoria* bacterium with P2, P4 DH lines containing *gds* gene (P1 x P2, P1 x P4, P3 x P2, P3 x P4) the F₁ generation was found susceptible. Examining 2,650 plants in the F₂ generation 2,023 (76.3 %) susceptible and 627 (23.7 %) resistant (*gds/gds* genotype) plants were obtained. Among the BC₁F₁ 1,200 plants produced with *gds* resistant P2 and P4 lines, following infection 628 (52.3 %) susceptible and 572 (47.7 %) resistant plants were obtained. The data proved the expected susceptible : resistant fission ratio of 3:1 (Chi² 2.54, df=1, p=0.111) and 1:1 (Chi² 2.61, df=1, p=0.11, p-values were simulated), which confirmed our previous conclusions (Szarka & Csillery 1995, 2001a).

According to the data of Jones et al. (2002) Pep 13 (which is the derivative of C44 series and originally comes from the crossing of PI 163192 and PI 264281) and

ECW12356 line coming from several back-crossings of PI 271322 lines reacted with non-hypersensitive reaction to infection with *X. vesicatoria* bacterium. According to their analysis two recessive genes (*bs5*, *bs6*) are responsible for the appearance of the symptoms. The non-hypersensitive reaction of the ECW 12356 line, which we also examined, is identical with the General Defense Reaction on the basis of the prognostic symptoms, which in the case of pepper is determined by the *gds* gene of monogenic recessive hereditary course.

According to our examinations, the *gds* gene, besides the mentioned PI items, is present in the Mexican gene centre of *C. annuum* species and in the old “primitive” small fruit type varieties spread in different countries in the world from the Mexican gene centers and cultivated at several places even today.

We are still working on the analysis of the F₁ and F₂ generation of the crossings of pepper lines containing recessive *gds* and dominant *Bs-2* resistance genes against *X. vesicatoria* bacterium.

In F₁ generation we did not get the prognostic symptom typical of the well-known impact of dominant and recessive genes. The tissues of the infiltrated leaf patches thickened, became slightly chlorotic and showed only slight purple-red coloring. This means that the theoretically expected dominant impact of the *Bs-2* gene was repressed and only slight purple color referred to its presence. On the other hand, the recessive *gds* gene whose phenotype appearance was not expected in F₁ in any way caused tissue thickening and slight chlorosis.

On the basis of our knowledge concerning symptoms and pathophysiology, this phenomenon is explained by the fact that the stimulus threshold of GDR is much lower than that of HR. GDR reacts to the provocation of already one microbe cell, while HR begins to act only after greater propagation of the pathogen. GDR beginning to act even after non-specific stimulus is suitable to play the role of plant immune system, while HR is restricted to the local inhibition of specialized microbes, pathogens.

The two reactions differ not only in the extent of the stimulus threshold but in the speed of the reaction, too. The speed of GDR is much higher than that of HR. As a result, although stress caused by infection performed by inoculum of 10⁷ bacteria cell/ml concentration exceeds the value of stimulus threshold necessary for the action of HR, its phenotype appearance does not take place because GDR eliminated stress (Szarka et al. 2002).

Changes in the glucose contents clearly indicate the role of general and specific defense reactions in the defense of stress caused by microbes and their strategic relations. GDR is faster than HR but its use of glucose is continuous and greater, while HR is characterized by one-off and small-scale glucose consumption (Szarka 2002, Szarka et al. 2002).

Analysis of time-dependant changes of peroxidase enzyme activity aimed at eliminating stress, methylated compounds and related to them formaldehyde in the tested three plant reactions led to the conclusions of different strategies. GDR with low stimulus threshold and fast reaction reacts to stress caused by inoculation in an hour. The processes induced by stress, characterized with time-dependant changes of the tested compounds start belatedly and take place slowly in susceptible plants with low level general defense system, not containing specific resistance gene. Plants containing specific resistance gene, in accordance with its role in excluding the pathogen, react to stresses only later, after reaching higher stimulus threshold (Sardi et al. 2003).

Our experiences show that resistance breeding with the use of specific resistance genes, early selection on the basis of HR causes the weakening, destruction of GDR, although pathogen specific resistance genes act optimally, efficiently and durably in the background ensured by GDR which constitutes the fundamental phenomenon of life of plants. The general defense system of plants is destroyed during selection for HR, consequently exposure of plants to other pathogens is also increasing.

As a result of strong selection to *Bs-2* gene causing *Xanthomonas* resistance and L^1 , L^3 alleles of *L* gene causing TMV resistance, exposure of the plants to *Leveillula taurica* leaf fungus has increased. Similar processes take place against rust race in case of wheat species containing several specific resistances. In case of great epidemic, susceptible types produced more than resistance types, which died to a high degree as a result of hypersensitive reactions (Barabas & Matuz 1983). According to the authors „Presumably, in addition to the race-specific resistance gene defense mechanism there is a second system of defense being independent of the former, the tolerance, the presence or absence of which strengthens or weakens the disease resistance based on resistance genes.”

In our opinion, testing the general defense system of the used plant lines is indispensable in course of resistance breeding, since hypersensitive reactions built on the general defense system constitute the unity of the defense system of plants.

Acknowledgements

We thank you for following these guidelines carefully.

National Research and Development Program. Szechenyi Project, Gold of Hungaria 4/006.

Esasem S.p.A. Seed Company, Casaleone, (Italy).

References

- Barabas, Z. & Matuz, J. 1983: Yield of winter wheat genotypes as affected by leaf rust and powdery mildew epidemics as well as by the type of resistance. *Novenytermesztes* 32.3:193-198.
- Black, L.L. Hobbs H.L. & Gatti, J.M. 1991: Tomato spotted wilt virus resistance in *Capsicum chinense* PI 152225 and PI 159236. *Plant Disease* 75:836.
- Boukema, I.W. 1980: Allelism of genes controlling resistance to TMV in *Capsicum L.* *Euphytica* 29:433-439.
- Boukema, I.W. 1982. Resistance to a strain of TMV in *Capsicum chacoense* Hunz. *Capsicum Newsletter* 1:49-51.
- Cook, A.A. & Stall, R.E. 1963: Inheritance of resistance in pepper to bacterial spot. *Phytopathology* 53:1060-1062.
- Csillery, G. & Rusko, J. 1980: The control of a new Tobamo virus strain by a resistance linked to anthocyanin deficiency in pepper (*Capsicum annuum L.*). IVth meeting of the *Capsicum Working Group of Eucarpia*, Wageningen, The Netherland. 40-43.
- Dumas de Vault, R. Chambonet, D. & Pochard, E. 1981: Culture in vitro d' antheres de piment (*Capsicum annuum L.*): amelioration des taux d' obtention de plants chez differents genotypes par de traitements a +35 °C. *Agronomie* 1:859-864.
- Fery, R.L. & Dukes, P.D. 1996: The inheritance of resistance to the southern root-knot nematode in Carolina Hot Cayenne pepper. *J. Am. Soc. Hort. Sci.* 121:1024-1027.
- Hare, W.W. 1957: Comparative resistance of seven pepper varieties to five root-knot nematodes. *Phytopathology* 46:669-672.
- Hendy, H. Pochard, E. & Dalmaso, A. 1985: Transmission hereditaire de la resistance aux nematodes Meloidogyne Chitwood (Tylenchida) portee par deux lignes de *Capsicum annuum L.*: etude de descendances homozygotes issues d' androgenese. *Agronomie* 5:93-100.
- Holmes, F.O. 1937: Inheritance of resistance to tobacco mosaic disease in the pepper. *Phytopathology* 27:637-642.

- Jones, J.B. Minsavage, G.V. Roberts, P.D. Johnson, R.R. Kousik, C.S. Subramanya, S. & Stall, R.E. 2002: A non-hypersensitive resistance in pepper to the bacterial spot pathogen is associated with two recessive genes. *Phytopathology* 92.3:273-277.
- Kim, B.S. & Dempsey, A.H. 1977: Additional sources of resistance to bacterial spot of pepper. *Plant Disease Report* 61:684-686.
- Sardi, E., Szarka, E., Csillery, G., Szarka, J. & Stefanovits-Banyai, E. 2003: Possible role of formaldehyde cycle in the general defense system of plants. 6th International Conference on Role of Formaldehyde in Biological Systems. Methylation and Demethylation Processes. Pecs, Hungary, 64.
- Stakman, E. C. 1915: Relation between *Puccinia graminis* and plants highly resistant to its attack. *J. Agr. Res.* 4, 139-200.
- Szarka, J. & Csillery, G. 1995: Defence system against *Xanthomonas campestris* pv. *vesicatoria*. IXth Eucarpia Meeting on Genetics and Breeding on Capsicum and Eggplant. Budapest, Hungary. 184-187.
- Szarka, J. & Csillery, G. 2001a: General defense system in the plant kingdom. *International Journal of Horticultural Science*, Budapest, Vol. 7. No.1. 79-84.
- Szarka, J. & Csillery, G. 2001b: General defense system in the plant kingdom II. *International Journal of Hort. Sci.* Budapest, Vol. 7. No.3-4. 73-77.
- Szarka, J. Sardi, E. Szarka, E. & Csillery G. 2002: General defense system in the plant kingdom III. *International Journal of Hort. Sci.* Budapest, Vol. 8. No.3-4. 45-54.
- Szarka, E. 2002: Examination of the general defense system of plants in pepper-*Xanthomonas* host-pathogen relation. Szent Istvan Univ., Horticulture Faculty, Dep. of Gen. and Plant Breeding. XXVIIIth Scientific Students' Conf. Budapest. 1-33. (in Hungarian language)
- Ward, H. M. 1902: On the relations between host and parasite in the bromes and their brown rust *Puccinia dispersa* Erkiss. *Ann. Bot.* 16 : 223-315.

Heredité of *Tomato mosaic virus* (ToMV) and *Potato virus Y* (PVY) resistance in eggplant (*Solanum melongena* L.)

Marie-Christine Daunay¹, Carole Caranta¹, Frédérique Pédrón¹, Chrystel Deulvot¹, Marie-Hélène Dussault¹, André Moretti¹, Evelyne Jullian¹, Sandrine Ruffel¹, Frédéric Moquet², Mansour Majde², Kahsay Gébré Selassié³, Patrick Gognalons³, Georges Marchoux³

¹ I.N.R.A., Génétique et Amélioration des Fruits et Légumes, BP 94, 84143 Montfavet Cedex, France, ² Gautier Semences, BP 1, 13630 Eyragues, France, ³ I.N.R.A., Pathologie végétale, BP 94, 84143 Montfavet Cedex, France. Contact: daunay@avignon.inra.fr, Tel +33 4 32 72 27 24

Abstract: The purpose of this research was to determine the genetic control of resistance against ToMV (*Tomato mosaic virus*, genus *Tobamovirus*) and PVY (*Potato virus Y*, genus *Potyvirus*) of a set of genitors recently identified at INRA, and to search for molecular markers linked to the resistance factors. The availability of a complete molecular map of eggplant makes now possible comparisons between Solanaceous crops. To determine whether synteny occurs between eggplant, tomato, tobacco and pepper for resistance genes controlling the same viruses, RFLP markers linked to the locus *Tm1*, *Tm2* (tomato), *N* (tobacco), *L* (pepper) controlling resistance against Tobamoviruses, and *pvr2* and *Pvr4* (pepper), *pot1* (tomato), *Ry* (potato) controlling resistance against Potyviruses were tested in eggplant.

F1, F2 and BC1 progenies from the cross between an accession of *S. melongena* (MM 136) resistant against ToMV pathotype 0 and a susceptible one (MM 608) have been inoculated two weeks after sowing, by manual cotyledons abrasion. The results show that a dominant gene, named *Tbm-1* (for “*tobamovirus* 1”), is responsible for the resistance. This gene controls a hypersensitive reaction on the inoculated organs and an absence of symptoms on the systemic leaves. Moreover, heterozygous plants for *Tbm-1* manually inoculated at the cotyledon stage present generalized systemic necrosis, similarly to the *Tm2* gene from tomato. Because of the low level of RFLP polymorphism between the two *S. melongena* accessions, it was not possible to determine whether RFLP markers linked to phenotypically similar resistance gene in other solanaceous crops are linked or not to *Tbm-1*. A higher level of polymorphism was obtained using AFLP markers; these markers are currently used to localize *Tbm-1* on the eggplant genome.

For studying the heredity of PVY resistance, F1, F2 and BC1 interspecific progenies from the cross *S. linnaeanum* MM 195 (susceptible) and *S. melongena* MM 738 (resistant) have been used. Plants were inoculated twice, three and then four weeks after sowing. One month after the second inoculation, presence/absence of PVY systemic infection was assessed by ELISA. The results obtained indicate that a single recessive gene, named *ptv-1* (for “*potyvirus*” 1) is involved in the resistance. Phenotypically, *ptv-1* shares strong similarities with *pvr2* from pepper and *pot-1* from tomato. Some of the RFLP markers linked to *pvr2* and *pot-1* presented polymorphism between MM 195 and MM 738 and are currently under mapping to determine whether *ptv-1* is an ortholog of *pvr2* and *pot-1*.

Keywords: *Solanum melongena*, eggplant, varieties, *Solanum linnaeanum*, interspecific progenies, virus, resistance, heredity, genetic control, synteny, solanaceae.

Introduction

In field and greenhouse conditions, eggplant is much less susceptible to viruses than other Solanaceous crops such as tomato and pepper. Though many viruses have been described on eggplant (Marchoux *et al.*, 2003), the damages on the cultivated plants remain generally limited. *Tobamoviruses* (*Tobacco mosaic virus* –TMV- and *Tomato mosaic virus* –ToMV-) induce on eggplant a green mosaic with vein clearing, or an “aucuba” yellow mosaic type. Transmitted by contact, they can be hosted by hands, garments, pruning tools, greenhouse infrastructures, compost, plant waste, where they can survive

several months. *Potato virus Y* (PVY), frequent on Solanaceous crops such as potato, tobacco, tomato and pepper, is very rarely found on eggplant (Marchoux *et al.*, 2000). Only some strains attack eggplant, inducing a mosaic with ring spots on the oldest leaves at the basis of the plant (Edwardson & Christie, 1997; Bhat *et al.*, 1999). On the other hand, PVY has been isolated from *Solanum* species related to eggplant, such as *S. aethiopicum*, *S. macrocarpon* and *S. sisymbriifolium* presenting mottling symptoms. PVY is a non persistent virus, transmitted by different aphid species.

Investigating *Solanum melongena* germplasm, Rast (1991) and Pédrón (1999) identified resistances belonging to the Hypersensitive Reaction type (HR) towards TMV and ToMV. These results showed that a given accession may display a resistant behaviour against ToMV alone, or against ToMV and TMV, and that there was in some cases, some intra accession heterogeneity. Pédrón (1999) identified resistances against ToMV and/or TMV, depending on the eggplant accessions, based, as those identified by Rast (1991), on local necrotic reactions.

Marchoux & Gebre Sélassié (unpublished results) have identified a susceptibility towards PVY in *Solanum linnaeanum* MM 195, which is crossable with *S. melongena* (generally resistant to this virus).

The objectives of this study are (1) to determine the genetic control of the resistances in eggplant against ToMV and PVY, and (2) to search for molecular markers linked to the resistance factors involved, by testing markers known to be linked to similar resistances in other Solanaceous crops (tomato, tobacco, potato, pepper).

Material and Methods

Plant material

S. melongena MM 608 susceptible (S), *S. melongena* MM 136 resistant (R) against ToMV pathotype 0 have been used, as well as the F1 'MM 608 x MM 136', the F2, and the BC1 progenies from the cross 'F1 x MM 608' noted BC1-S and from the cross 'F1 x MM 136' noted BC1-R. Sowing is done in pans in greenhouse, in spring which is a good period for the development of the virus.

S. linnaeanum MM 195 susceptible (S), *S. melongena* MM 738 resistant (R) have been used, as well as the F1 'MM 195 x MM 738', the F2, and the BC1 progenies from the cross 'F1 x MM 195' noted BC1-S and from the cross 'F1 x MM 738' noted BC1-R. Sowing is done in pans in a climatic chamber, regulated as follow: 14h day at 24°C and 10h dark at 18°C.

Virus material and mechanical inoculation

ToMV strain 0 is multiplied on the tomato variety Monalbo: leaves are cut, then ground, and their juice is diluted in distilled water (1/4 V/V). Thirty minutes later, inoculum is filtrated and stored at -20°C. Before inoculation, carborundum is added to the unfrozen inoculum. Fourteen, or 35 or 42 days old plantlets are inoculated by manual rubbing of the cotyledons and the first leave.

PVY strain LYE84 is multiplied during 15 days on *Nicotiana tabaccum* var. xanthii grown in a climatic chamber, regulated as already described. Inoculum is prepared by grinding leaves in 0.03M Na₂HPO₄ + 0.2% sodium diethyldithiocarbamate (DIECA) at the rate of 1g of tissue for 4ml of buffer. Carborundum and activated charcoal (75mg/ml of each) are added to sap extract. Twenty four days after sowing, the cotyledons as well as the first leave are inoculated by manual rubbing. A second inoculation is carried out six days later, in order to avoid the frequently observed problem of escaped plantlets.

Resistance evaluation

Resistant or susceptible behaviours against ToMV are evaluated by a visual observation of the symptoms, 7 days, 14 days, 21 days and 28 days after inoculation. Two tests on 14 days old plantlets were carried out, with all the progenies (test 1 and test 2). A third test was done on older plants aged 35 and 42 days, only with the parents and the F1 (test 3).

Because the symptoms induced by PVY are very weak (only a slight mosaic), presence/absence of PVY systemic infection was checked 31 days after inoculation by DAS-ELISA (Clark & Adams, 1977). PVY resistance was evaluated during two independent tests.

Molecular tagging

DNA extractions were done as described by Bernatzky & Tanksley (1986) and by Fulton *et al.* (1995) for parents and F2 progenies, respectively. RFLP procedure was described in Botstein *et al.* (1980) and Doganlar *et al.* (2002).

For *Tbm-1* tagging, screening for RFLP polymorphism between MM 608 and MM 136 was performed with 18 restriction enzymes (*Bam*HI, *Dra*I, *Eco*RI, *Eco*RII, *Eco*RV, *Hae*III, *Hind*III, *Hinf*I, *Hpa*II, *Kpn*I, *Mse*I, *Pst*I, *Rsa*I, *Sau*3AI, *Sca*I, *Sst*I, *Taq*I, *Xba*I) and with RFLP markers linked to *Tobamovirus* resistance genes in other Solanaceae: TG31 and TG133 linked to *Tm-1* in tomato, TG3, TG35, CD3 and CD8 linked to locus *Tm-2* (Tanksley *et al.*, 1992) in tomato and TG36 linked to *L* in pepper (Lefebvre *et al.*, 2002).

For *ptv-1* tagging, screening for RFLP polymorphism between MM 195 and MM 738 was performed with 8 restriction enzymes (*Dra*I, *Eco*RI, *Eco*RII, *Eco*RV, *Hae*III, *Hind*III, *Sca*I and *Xba*I) with RFLP markers linked to phenotypically similar PVY resistance genes in other Solanaceae: CT31 and TG585 linked to both *pot-1* in tomato and *pvr2* in pepper (Parrella *et al.*, 2002) and a *eIF4E* cDNA from tobacco (named GC123). *eIF4E* encodes for the eucaryotic translation initiation factor 4E and corresponds to *pvr2* and *pot-1* (Ruffel *et al.*, 2002).

Results and Discussion

Genetic control of ToMV resistance

When inoculated at the cotyledon stage (14 days-old plants), the susceptible parent MM 608 displays (as soon as seven days after inoculation) aucuba mosaic on and goffering of the systemic leaves (leaves situated above the level of the inoculated organs). The resistant parent MM 136 presents strong necrotic lesions on the inoculated organs, but no symptoms on the systemic leaves. Four days after inoculation, F1 plants present the same phenotype as the resistant parent. However later on, a systemic necrosis develops up to the death of the plants. The three types of symptoms are found on the F2 progeny (mosaic, local necrosis, systemic necrosis). BC1-S presents plants of a phenotype either similar to that of the F1 or to that of the susceptible parent. BC1-R presents plants of a phenotype either similar to that of the F1 or to that of the resistant parent.

To clarify the resistant or susceptible behaviour of the F1 plants, and their F2 and BC1 counterparts (displaying local necrosis few days after inoculation, followed by a general necrosis and plant death), plants were inoculated later when 35 and 42 days-old (test 3). In these conditions, the F1 plants display a resistant phenotype similar to the resistant parent MM 136, with local necrosis on inoculated organs and no systemic symptoms. This variable behaviour of plants heterozygous for ToMV resistance is already well known in tomato: when inoculated at a very young stage and with a high pressure of inoculum, tomato plants heterozygous for the resistance allele at the *Tm-2* locus display an apparently susceptible phenotype (systemic necrosis), though when inoculated later, they display a resistant behaviour (local necrosis).

Table 1 shows the proportion of resistant and susceptible plants found in tests 1 and 2. The plants presenting either a local necrosis, or a local necrosis followed later on by the

general necrosis were classified as resistant ones. The data obtained for all segregating progenies (F2, BC1-S and BC1-R) indicate that the resistance is controlled by a single dominant gene. The presence of two susceptible plants in BC1-R (test 2) is abnormal and cannot be explained yet. We name the dominant resistance gene *Tbm-1* for 'Tobamoviruses resistance gene 1'. *Tbm-1* controls an HR reaction.

Table 1. Inheritance of ToMV resistance in *S. melongena* MM 136 (test 1 & 2). Number of susceptible [S] and resistant [R] plants observed, and Chi2 tests for the hypothesis of a resistance controlled by a single dominant gene (P=0,05, 1 degree of freedom -df- for 2 classes). * = hypothesis accepted.

ToMV test 1						
Genotype	tested	[S] plants	[R] plants	Exp. Ratio [S]:[R]	Chi 2 value	Probability (%)
MM 608	10	10	0	100 % [S]		
MM 136	10	0	10	100% [R]		
F1	11	0	11	100% [R]		
F2	150	34	116	1 : 3	0,44*	50.9
BC1-S	105	62	43	1 : 1	3,44*	6.4
BC1-R	103	0	103	100% [R]		
ToMV test 2						
MM 608	10	10	0	100 % [S]		
MM 136	10	0	10	100% [R]		
F1	10	0	10	100% [R]		
F2	72	23	49	1 : 3	1,85*	17.4
BC1-S	91	42	49	1 : 1	0,54*	46.3
BC1-R	102	2	100	100% [R]		

We have investigated whether the *distinguo* between homozygous resistant plants and heterozygous resistant plants, based on the symptoms expression (local necrosis for homozygous plants, systemic necrosis for heterozygous plants) was valuable or not (Table 2). The results show that the phenotype is not a very reliable image of the genotype (null hypothesis verified at P=0,05 in 4 cases out of 6 tested).

Table 2. Inheritance of ToMV resistance in *S. melongena* MM 136 (test 1 & 2). Number of homozygous susceptible plants [S], of homozygous and heterozygous resistant plants [R], identified on the phenotypic basis (symptoms) and Chi2 tests for the hypothesis of a resistance controlled by a single dominant gene (P=0,05, 2 degrees of freedom for 3 classes, and 1 df for 2 classes). * = hypothesis accepted.

ToMV test 1							
Genotype	tested	homozygous [S _{homoz}]	homozygous [R _{homoz}]	heterozygous R _{heteroz}	Expected ratio [S _{homoz}]:[R _{hom}]:[R _{hetero}]	Chi 2 value	Prob. (%)
F2	150	34	40	76	1 : 1 : 2	0,51*	77.6
BC1-S	105	62	2	41	1 [S _{homoz}] : 1 [R _{hetero}]	4,24	3.8
BC1-R	103	0	42	61	1 [R _{hom}] : 1 [R _{hetero}]	3,50*	6.1

ToMV test 2							
F2	72	23	16	33	1 : 1 : 2	1,85*	39.4
BC1-S	91	42	9	40	1 [S _{homoz}] : 1 [R _{hetero}]	0,94*	82.5
BC1-R	102	2	61	39	1 [R _{hom}] : 1 [R _{hetero}]	4,79	2.3

Genetic control of PVY resistance

The parental line MM 195 and the F1 were susceptible to PVY-LYE84, presenting Coat-Protein (CP) accumulation in systemic leaves similar to the susceptible control, whereas PVY CP was never detected in tissues of the resistant line MM 738. The segregation obtained in F1, BC1-R and BC1-S progenies (Table 3) indicate that PVY resistance in eggplant is controlled by a single recessive gene, named *ptv-1* for ‘potyvirus resistance gene 1’. This gene is phenotypically similar to *pvr2* from pepper and *pot-1* from tomato *i.e.*, PVY was never recovered from inoculated tissues nor by ELISA nor by RT-PCR assay (data not shown).

Table 3. Inheritance of PVY-LYE84 resistance in *S. melongena* MM 738 (test 4 & 5) Number of susceptible [S] and resistant [R] plants observed, and Chi2 tests for the hypothesis of a resistance controlled by a single recessive gene (P=0,05; df = 1).

Genotype	Nber of plants tested	Nber of [S] plants	Nber of [R] plants	Expected ratio [S]:[R]	Chi2 value	Probability (%)
Test 4 (PVY)						
MM 195	10	10	0	100% [S]		
MM 738	10	0	10	100 % [R]		
F1	8	8	0	100% [S]		
F2	80	63	17	3 : 1	0,60*	43.9
BC1-S	68	65	3	100 % [S]		
BC1-R	60	26	34	1 : 1	1,07*	30.2
Test 5 (PVY)						
MM 195	10	10	0	100% [S]		
MM 738	10	0	10	100 % [R]		
F1	10	10	0	100% [S]		
BC1-R	120	58	62	1 : 1	0.13*	71.5

Molecular tagging of ToMV resistance factor *Tbm-1*

Though all the probes hybridise on different eggplant loci, the 106 combinations ‘restriction enzyme x probe’ tested were monomorphic between *S. melongena* MM 608 and MM 136. This result is in line with the poor polymorphism already found by Karihaloo *et al.* (1995) within *S. melongena* germplasm for RAPDs. The mapping of *Tbm-1* is currently underway by using AFLP markers and ‘Bulk Segregant Analysis’ methodology. AFLP markers have proven to be much more polymorphic within *S. melongena* germplasm (Mace *et al.*, 1999).

Molecular tagging of PVY resistance factor *ptv-1*

RFLP polymorphism between the two parents has been found for the probes tested (CT31, TG585 and GC123), for most of the enzymes used. Then, these RFLP markers were mapped on the BC1-R progeny segregating for *ptv-1*. None of these RFLP markers appear to be linked to *ptv-1* suggesting that *ptv-1* is not an ortholog of *pvr2* and *pot-1*. These results are currently under confirmation by the mapping of *ptv-1* on the F2/F3 progeny used to generate the eggplant genetic linkage map (Doganlar *et al.*, 2002).

Acknowledgements

The authors thank the team of the experimental of the INRA Unit on Genetics and Breeding of Fruits & Vegetables, for taking care of the plants.

References

- Bhat A.I., Varma A., Pappu H.R., Rajamannar M., Jain R.K., Praveen S., 1999. Characterization of a potyvirus from eggplant (*Solanum melongena*) as a strain of potato virus Y by N-terminal serology and sequence relationships. *Plant Pathol.* 48: 648-654.
- Bernatzki R. & Tanksley S.D., 1986: Genetics of actin-related sequences in tomato. *Theor. Appl. Genet.* 72 (3) : 314-321.
- Botstein D., White R.L., Skolnick M., Davis R.W., 1980: Construction of a genetic linkage map in man using restriction fragment length polymorphism. *Am. J. Human Genet.* 32: 314-331.
- Clark M.F., Adams A.N., 1977: Characteristics of the microplate method of enzyme-linked immunosorbent assay for the detection of plant viruses. *Journal of General Virology* 34 (3): 475-483.
- Deulvot C., 2002 : La résistance de l'aubergine aux virus ToMV et PVY : déterminisme génétique et cartographie comparée chez les Solanacées ». Mémoire de DESS « Gestion de la bio-diversité : méthodologie d'étude et de valorisation des ressources génétiques », Univ. Pierre & Marie Curie, Paris VI : 52 pages.
- Doganlar S., Frary A., Daunay M.C., Lester R., Tanksley S., 2002: A comparative genetic linkage map of eggplant (*Solanum melongena*) and its implications for genome evolution in the Solanaceae. *Genetics* 161: 1697-1711.
- Edwardson J.R. & Christie R.G., 1997: Viruses infecting peppers and other Solanaceous crops. *Fla. Agric. Exp. Stn Bull. Univ. Fla. Monograph*, 18: 766 pages.
- Fulton T.M., Chunwongse J. Tanksley S.D., 1995: Microprep protocol for extraction of DNA from tomato and other herbaceous crops. *Plant Mol. Biol. Rep.* 13 (3) :207-209.
- Karihaloo J.L., Brauner S., Gottlieb L.D., 1995: Random amplified polymorphic variation in the eggplant, *Solanum melongena* L. (Solanaceae): *Theor. Appl. Genetics*, 90: 767-770.
- Lefebvre V., Pflieger S., Thabuis A., Caranta C., Blattes A., Chauvet J.C., Daubèze A.M., Palloix A., 2002: Towards the saturation of the pepper linkage map by alignment of the three intraspecific maps including known-function genes. *Genome* 45: 839-854.
- Mace E.S., Lester R.N., Gebhardt C.G., 1999 : AFLP analysis of genetic relationships among the cultivated eggplants , *Solanum melongena* and its wild relatives (Solanaceae). *Theor. Appl. Genetics*, 99 : 626-633.
- Marchoux G., Gebre Sélassié K., Gognalons P., Arteaga M.L., 2000 : Le virus de la pomme de terre s'adapte à d'autres Solanacées. *Phytoma- La défense des végétaux* (533) : 45-47.

- Marchoux G., Gognalons P., Daunay M.C., 2003 : Aubergine: Evolution des problèmes de viroses. Fruits et Légumes (217) : 42-44.
- Parrella G., Ruffel S., Moretti A., Morel C., Palloix A., Caranta C., 2002: Recessive resistance genes against potyviruses are localized in collinear genomic regions of the tomato (*Lycopersicon* spp.) and pepper (*Capsicum* spp.) genomes. Theor. Appl. Genet. 105 :855-861.
- Pédron F., 1999 : Ressources génétiques de l'aubergine : facteurs influençant la germination et évaluation pour la résistance à cinq virus. Mémoire de fin d'Etudes E.N.I.T.H.P./I.N.H., Angers (FRA) : 55 p + annexes.
- Rast A.Th.B., 1991 : Screening germplasm of *Solanum melongena* for resistance to the eggplant strain of bell pepper mottle virus (BPMV) and other tobamoviruses. Capsicum Newsletter (10): 26-32.
- Ruffel S., Dussault M.H., Palloix A., Moury B., Bendahmane A., Robaglia C., Caranta C., 2002 : A natural recessive resistance gene against potato virus Y in pepper corresponds to the eukaryotic initiation factor 4E (eIF4E). Plant J. 32: 1067-1075.
- Tanksley S.D., et al., 1992 : High-density molecular linkage maps of the tomato and potato genomes. Genetics 132:1141-1160.

Fine-mapping of a quantitative resistance locus to *Phytophthora* spp. and development of NIL-QTLs in pepper

Véronique Lefebvre, Julien Bonnet, Christine Boudet, Marianne Hédont, Patrick Signoret, Thérèse Phaly, Anne Blattes, Sarah Danan, Alain Palloix

INRA, Unité de Génétique et Amélioration des Fruits et Légumes, B.P. 94, 84143 Montfavet Cedex, France. Contact: veronique.lefebvre@avignon.inra.fr

Abstract: *Phytophthora capsici* Leon., the Oomycete causing pepper root rot, is a major threat to pepper production, and ranked as the second most devastating disease worldwide. Several sources of resistance have been reported in *Capsicum annuum* germplasm but all exhibited a partial effect with polygenic inheritance. QTL analysis was performed in three intraspecific pepper populations, each involving an unrelated resistant accession. Alignment of the three genetic maps using common markers enabled the comparison of the QTL locations among the three resistant accessions. One major effect QTL was located in the same genomic region on chromosome P5 in the 3 mapping populations. At the P5 QTL, the alleles from the 3 distinct resistant accessions prevented from the development of *P. capsici* isolates of different aggressiveness. This locus showed a conserved genomic position with a *P. infestans* resistance QTL in potato. A fine-mapping experiment of the major effect QTL was achieved using a F5-recombinant inbred line population issued from the F2 (Yolo Wonder x CM334). The F5 RIL population enabled to map markers with 0.17 cM accuracy and to reduce the confidence interval around the QTL from 60 cM in F2 to less than 10 cM in F5. Marker density was also increased in the QTL region with more than 15 markers located in the QTL interval. Near-isogenic lines for this QTL (NIL-QTL) were created by marker-assisted selection from the two resistant donor lines, Perennial and CM334.

Keywords: *Capsicum annuum*, root rot, *Phytophthora capsici*, Oomycete, disease resistance, QTL analysis, fine-mapping, near-isogenic line.

Introduction

Phytophthora capsici Leon., the Oomycete causing pepper root rot, is a major threat to pepper production, and ranked as the second most devastating disease worldwide. Several sources of resistance have been reported in *Capsicum annuum* germplasm but all exhibited a partial effect with polygenic inheritance (Lefebvre et Palloix 1996). QTL analysis was performed in three intraspecific pepper populations, each involving an unrelated resistant accession. Alignment of the three genetic maps using common markers (Lefebvre et al. 2002) enabled the comparison of the QTL locations among the three resistant accessions. One major effect QTL, named *Phy-P5*, was located in the same genomic region on chromosome P5 in the 3 mapping populations. Another QTL on chromosome P10 was conserved between two populations, the other QTLs being specific to a single cross (Thabuis et al. 2003).

Several characteristics make of the *Phy-P5* QTL a good choice for investigating quantitative resistance to Oomycete. First, *Phy-P5* confers high resistance level to *Phytophthora* in pepper. Second, this broad-spectrum QTL affects several strains of *P. capsici*. Preliminary experiments showed it partially controlled *P. parasitica* isolates (Allagui et al. 2001, unpublished results of the lab). Third, *Phy-P5* is syntenic to a QTL that confers resistance to *P. infestans* in potato. Forth, *Phy-P5* is linked to a QTL conferring resistance to the powdery mildew agent of pepper, *Leveillula taurica* (Pflieger et al. 2001, Thabuis et al. 2003, Lefebvre et al. 2003).

Characterization of a QTL is not an easy task; "Mendelisation" of the genetic character is required. This is carried out through construction of near isogenic lines (NILs) and identification of plants that differ only at the targeted QTL region.

This paper reports the fine-mapping of the *Phy-P5* QTL, using recombinant progenies, and a high throughput marker technique, which is here the AFLP technique. Markers were added in this genomic region, thanks to the Bulk Segregant Analysis (BSA) method, in order to saturate this region with numerous markers and to find narrowly linked markers to the resistance QTL. Two near-isogenic lines were developed from two resistant accessions, Perennial and CM334. They contain a single introgression corresponding to the *Phy-P5* QTL in the Yolo Wonder genetic background.

Material and methods

Plant material

The two parents of the fine-mapping population were the resistant *C. annuum* Mexican hot pepper accession CM334, and the susceptible *C. annuum* American bell-pepper variety Yolo Wonder. A total of 297 F5-recombinant inbred lines were derived from the F2 population named YC (Lefebvre et al. 2002). The genetic map was constructed with the 297 F5-RIL (named F5YC) using AFLP and RFLP markers. The F5YC population enabled to map markers with 0.17 cM accuracy ($r=R/(2-2R)$ with $R=1/297$). Resistance assessment was performed on the corresponding F6 families (named F6YC).

Two near-isogenic backcross plants (NIBC) differing by their allele at the QTL *Phy-P5* were constructed from two resistant accessions Perennial and CM334 by introgressing their allele at the *Phy-P5* QTL into the susceptible genetic background Yolo Wonder.

We marker-selected the NIBC-Phy-P5-Per containing an heterozygous Perennial segment at *Phy-P5* in the Yolo Wonder genetic background, from the donor line DH236 using 2 backcrosses to Yolo Wonder. DH236 was selected from the PY doubled haploid mapping population, derived by androgenesis from a single F1 issued from the cross between the resistant Indian line Perennial and the susceptible cultivar line Yolo Wonder (Lefebvre et Palloix 1996). During each backcross generation, foreground marker-assisted selection (MAS) maintained the heterozygous Perennial allele at the QTL *Phy-P5*, and background MAS permitted the recovery of homozygous Yolo Wonder genotypes outside the QTL interval. The BC1-212 plant heterozygous at DNA markers spanning the QTL *Phy-P5* was selected from among 25 BC1 plants, and backcrossed to Yolo Wonder. The BC2-110 plant (corresponding to the NIBC-Phy-P5-Per) heterozygous at DNA markers spanning the QTL *Phy-P5* was selected from among 63 BC2 plants.

We marker-selected the NIBC-Phy-P5-CM334, containing a single heterozygous CM334 segment at *Phy-P5* in an otherwise Yolo Wonder genetic background, from among 50 BC6-L2 plants issued from the phenotypic breeding population "Morelos" derived from crosses between the recipient susceptible line Yolo Wonder and the donor resistant line CM334 (Palloix et al., this issue; Thabuis et al. 2004, in press). The BC6-L2-195 plant corresponding to the NIBC-Phy-P5-CM334 was selected with 2 markers flanking *Phy-P5* to maintain the heterozygous CM334 allele at the QTL *Phy-P5* and 87 markers of the background to recover homozygous Yolo Wonder genetic background. Resistance assessment of the selected BC6-L2 plants was performed.

Two I1 populations were derived by selfing the two NIBCs in order to evaluate the QTL effect in a susceptible genetic background. 50 plants of each I1 population were assessed for resistance.

Resistance assessment

Two *Phytophthora capsici* isolates were used: S101, weakly aggressive, and S197, strongly aggressive. They were maintained as described by Clerjeau et al. (1976) and transplanted one week before inoculation on V8 agar plates maintained in the light at 22 °C.

Two artificial tests were performed. The ‘root inoculation test’ was performed as described by Palloix et al. (1988). It enabled us to compute the root rot index (RRI), a semi-quantitative resistance criterion ranging from 0 (resistant) to 5 (susceptible). The ‘stem inoculation test’, performed as described by Pochard and Daubèze (1980), allowed us to calculate three resistance components. Receptivity (REC, mm.day⁻¹) measured the pathogen spread in early infection process (3rd day post inoculation, DPI). Inducibility (IND, mm.day⁻²) measured the deceleration of the necrosis length between the 3rd and the 10th DPI. Stability (STA, mm.day⁻¹) measured the average speed of necrosis length between the 14th and the 21st DPI. Resistance assays were conducted at 22°C, 12h-light / 12h-night. In each test, parents and the F1 of the studied progeny were used as controls. The F6YC mapping population was assessed with S197 by a ‘root’ (40 plants per F6 family) and a ‘stem’ inoculation tests (6 plants per F6 family). The selected BC6-L2 plants originating from CM334 and the two NIBC-I1 populations were tested with S101 by a ‘stem’ inoculation test.

Molecular analysis

Genomic DNA was extracted from young leaves using the CTAB mini-prep procedure (Fulton et al. 1995). Linkage maps were constructed using MAPMAKER/EXP 3.0 (Lander et al. 1987) using the Haldane mapping function. QTLs were detected by composite interval mapping with the QTL CARTOGRAPHER software (Basten et al. 1997). The LOD threshold for QTL detection was arbitrarily chosen at LOD_≥2.7.

Results and discussion

Fine-mapping of the QTL Phy-P5

The means of the four resistance components observed in parental accessions, the F1 and the F6YC families are listed in Table 1.

Table 1. Means (\pm standard deviations) of resistance components.

Trait	Yolo Wonder	CM334	F1	F6YC
Root Index	4.7 \pm 0.4	1.7 \pm 1.6	4.3 \pm 0.7	3.8 \pm 1.1
Receptivity	7.7 \pm 1.7	4.4 \pm 1.6	6.1 \pm 1.7	6.6 \pm 1.6
Inducibility	0.0 \pm 0.8	-0.5 \pm 0.3	-0.5 \pm 0.3	0.5 \pm 0.3
Stability	3.4 \pm 3.4	0.4 \pm 0.5	2.4 \pm 2.0	2.3 \pm 1.8

A total of 339 markers were analysed in the F5YC mapping population. The framework map of F5YC is composed of 163 markers distributed in 16 linkage groups, with an average inter-marker distance of 5.8 cM (\pm sd=4.5 cM) for a total length of 850 cM. As a result of alignment with previously published maps (Lefebvre et al. 2002), 13 linkage groups were assigned to 11 of the 12 pepper chromosomes.

Four to eight QTLs depending on the resistance component, distributed on 10 linkage groups, were detected as affecting the *P. capsici* resistance. The major effect QTL

was detected on the linkage group assigned to the chromosome P5, confirming the results published on the YC mapping population (Thabuis et al. 2003).

This major effect QTL, named *Phy-P5*, was detected with a LOD score ranging from 9.5 to 16.6 for the resistance components STA, IR and REC. The confidence interval of the *Phy-P5* QTL was reduced from 40-60 cM according to the resistance components in the YC mapping population to 4-8 cM in the F5YC mapping population.

Twenty-three new markers were recently added in the *Phy-P5* genomic region, thanks to the Bulk Segregant Analysis (BSA) method and by screening 356 AFLP primer combinations, in order to saturate this region with numerous markers and to find narrowly linked markers to the resistance QTL. Other approaches are developed to increase the number of markers in this genomic region.

Near-isogenic lines differing at the QTL Phy-P5

NIBC-Phy-P5-Per: Theoretically, 6.25% of the alleles of the BC2 population issued from the cross between the DH line DH236 and Yolo Wonder originate from Perennial, allowing a "Mendelisation" of the *Phy-P5* QTL. The NIBC-Phy-P5-Per (or BC2-110) plant was selected with 106 markers distributed on the 12 chromosomes from a 63-plant BC2 population. Return to the recipient parent genome (Yolo Wonder) was very efficient as the recurrent genome content increased from 59% in the donor line DH236 to 96% in the selected NIBC plant. After two assisted backcrosses, all the non-carrier chromosomes, except a small segment of ~10 cM on the chromosome P11, were converted to the recipient genome. On the chromosome P5, the introgressed segment from Perennial was reduced to a segment of ~20 cM and was flanked by homozygous segments from Yolo Wonder of ~6 cM and ~80 cM. Resistance assessment of the I1 population derived from this NIBC showed a bimodal distribution closed to a 3:1 ratio indicating the Mendelian segregation of *Phy-P5* QTL (Figure 1).

NIBC-Phy-P5-CM334: The BC6-L2 plants were first genotyped with two AFLP markers flanking the *Phy-P5* QTL. Only the plants harbouring the CM334 alleles at both the markers were phenotypically evaluated for *P. capsici* resistance level to check that the *Phy-P5* allele effect was detected yet. Resistant plants were then screened with 87 AFLP markers regularly spread on the genome for applying a background selection. The selected NIBC-Phy-P5-CM334 plant had REC and IND values similar to those of CM334. The STA value was intermediate between those of the initial parents. All the non-carrier chromosomes were homozygous for Yolo Wonder. On the chromosome P5, the introgressed segment from CM334 was reduced to a segment of ~19 cM and was flanked by homozygous segments for Yolo Wonder of ~53 cM and ~100 cM. Resistance assessment of the I1 population derived from this NIBC showed a bimodal distribution close to a 3:1 ratio indicating the Mendelian segregation of *Phy-P5* QTL (Figure 1).

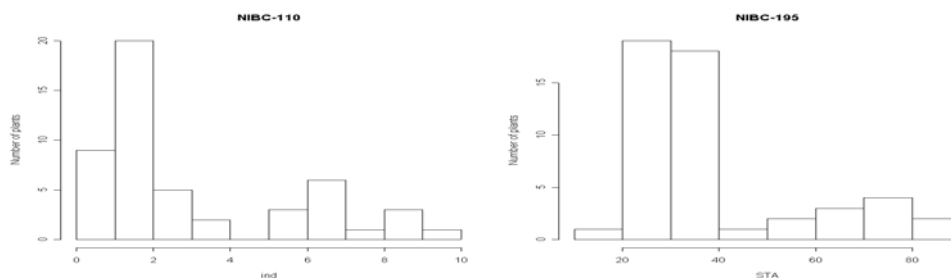

Figure 1. Histograms of the IND value for the I1 plants of the NIBC-Phy-P5-Per (left) and of the STA value for the I1 plants of the NIBC-Phy-P5-CM334 (right).

Prospects: The two NIBCs obtained are particularly useful for reducing the confidence interval around the QTL, for exploring if this major effect genomic region carries one or several QTLs, and for testing the allelism between the resistance QTLs to *P. capsici* from

Perennial and CM334. Markers spanning the introgressed QTL *Phy-P5* are being genotyped in all the resistant I1 plants. NILs homozygous for the resistant accessions' alleles at the QTL *Phy-P5* markers will be then selected and self pollinated to provide fixed NILs for further experiments. Segregating populations of thousands of individuals, derived from crossing NIBCs, will be used to narrow down the position of the QTL to a small genomic region in which candidate genes can be found.

Acknowledgements

This work and C. Boudet were financially supported by GENOPLANTE (2001-2003) and benefited of the technical help of 'Vilmorin' (Ledenon, France). The authors thank deeply A.M. Daubèze, G. Nemouchi, J.W. Hennart, M. Havard, M. Jacquet and S. Manin, for their help in the progeny production and experimental trials.

References

- Allagui MB, Daubèze AM, Palloix A. 2001: Looking for common genetic factors conferring resistance to *Phytophthora nicotianae* and *P. capsici* in the pepper line CM 334. XIth EUCARPIA Meeting on Genetics and Breeding of Capsicum and Eggplant, Antalya (Turkey), 2001/04/09-13, p: 275-278.
- Basten CJ, Weir BS, Zeng ZB. 1997: QTL cartographer: a reference manual and tutorial for QTL mapping. Dept of Statistics, North Carolina state University, Raleigh, NC, USA.
- Clerjeau M, Pitrat M, Nourisseau JG. 1976: La résistance du piment (*Capsicum annuum*) à *Phytophthora capsici*. IV. Etude de l'agressivité de divers isolats au niveau des feuilles, des tiges et du collet des plantes résistantes et sensibles. Ann Phytopathol 8: 411-423.
- Fulton TM, Chunwongse J, Tanksley SD. 1995: Microprep protocol for extraction of DNA of tomato and other herbaceous plants. Plant Mol Biol Report 13(3): 207-209.
- Lander E, Green P, Abrahamson J, Barlow A, Daley M, Lincoln S, Newburg L. 1987: Mapmaker: an interactive package for constructing primary genetic linkage maps of experimental and natural populations. Genomics 1: 174-181.
- Lefebvre V, Palloix A. 1996: Both epistatic and additive effects of QTLs are involved in polygenic induced resistance to disease: a case study, the interaction pepper–*Phytophthora capsici* Leonian. Theor Appl Genet 93: 503-511.
- Lefebvre V, Pflieger S, Thabuis A, Caranta C, Blattes A, Chauvet JC, Daubèze AM, Palloix A. 2002: Towards the saturation of the pepper linkage map by alignment of three intraspecific maps including known-function genes. Genome 45: 839-854.
- Lefebvre V, Daubèze AM, Rouppe van der Voort J, Peleman J, Bardin M, Palloix A. 2003: QTLs for resistance to powdery mildew in pepper under natural and artificial infections. Theor Appl Genet 107:661-666.
- Palloix A, Daubèze AM, Pochard E. 1988: Time sequences of root infection and resistance expression in an artificial inoculation method of pepper with *Phytophthora capsici*. J Phytopathol 123:12-24.
- Pflieger S, Palloix A, Caranta C, Blattes A, Lefebvre V. 2001: Defense response genes co-localize with quantitative disease resistance loci in pepper. Theor Appl Genet 103: 920-929.
- Pochard E, Daubèze AM. 1980: Recherche et évaluation des composantes d'une résistance polygénique : la résistance du piment à *Phytophthora capsici*. Ann Amélior Plant 26: 377-398.

- Thabuis A, Palloix A, Pflieger S, Daubèze AM, Caranta C, Lefebvre V. 2003:
Comparative mapping of *Phytophthora* resistance loci in pepper germplasm:
evidence for conserved resistance loci across Solanaceae and for a large genetic
diversity. *Theor Appl Genet* 106: 1473-1485.
- Thabuis A, Lefebvre V, Bernard G, Daubèze AM, Pochard E, Palloix A. 2004:
Phenotypic and molecular evaluation of a recurrent selection program for a
polygenic resistance to *Phytophthora capsici* in pepper. *Theor Appl Genet*, *in press*

Involvement of the eukaryotic translation initiation factor eIF4E in *Solanaceae-Potyvirus* interactions

Sandrine Ruffel¹, Marie-Hélène Dussault¹, Marie-Laure Lesage¹, André Moretti¹, Alain Palloix¹, Marie-Christine Daunay¹, Benoît Moury², Abdel Bendahmane³, Christophe Robaglia⁴, Carole Caranta¹

¹INRA- I.N.R.A., Génétique et Amélioration des Fruits et Légumes, BP 94, 84143 Montfavet Cedex, France. Contact: carole.caranta@avignon.inra.fr, Tel +334 32 72 27 10

²INRA, Pathologie Végétale, BP94, F-84143 Montfavet cedex, France

³INRA-URGV, 2 rue G. Cremieux, CP 5708, F-91057 Evry, France

⁴Lab. Plant Genetics and Biophysic, UMR 163 CNRS-CEA, Univ. Méditerranée, F-13108 St Paul-lez-Durance, France

Abstract : The recessive genes *pvr2* (from pepper) and *pot-1* (from tomato) controlling resistance to several potyviruses were cloned using a candidate gene approach and shown to correspond to an eukaryotic initiation factor 4E (*eIF4E*) gene [patent WO /066900] . Complementation experiments were conducted using a PVX-mediated transient expression assay. Expression of *eIF4E* from susceptible genotypes in resistant ones resulted in loss of resistance to subsequent potyvirus inoculation. Sequencing of *eIF4E* in 20 pepper lines revealed that few amino acid changes distinguish the susceptible and resistant genotypes and a strict correlation between the position of the substitutions and the phenotype conferred by each allele was observed, with a substitution common to all resistance alleles and additional allele-specific substitutions. In the tomato *eIF4E* protein, the substitutions involved in resistance are localized in the same region than those observed in pepper. Interestingly, preliminary results indicated that expression of the tomato *eIF4E* gene allows accumulation of PVY in resistant pepper genotypes. The role of *eIF4E* in potyvirus resistance was also investigated in eggplant for which most accessions are resistant to PVY.

Keywords: *Capsicum* spp., *eIF4E*, *Lycopersicon* spp., *Potato virus Y*, recessive resistance genes, *Tobacco etch virus*

Introduction

The genome of potyviruses is a single-strand positive-sense RNA molecule of approximately 10.000 nucleotides covalently linked to the VPg (Viral Protein genome-linked) at the 5' end and with a poly-(A) tail at its 3' end. The RNA is translated into a large polyprotein that is processed into ten functional proteins by the three virus-encoded proteinases. Due to the limited coding capacity of viral genomes, virus-host interactions involve many host proteins. To get insights into the molecular determinants of plant-potyvirus interactions, many studies have focused on the identification of host factors interacting with viral proteins through protein-protein interaction studies (Léonard et al. 2000; Schaad et al. 2000). In this study, we used a complementary approach: we cloned natural recessive resistance genes against potyviruses that are predicted to correspond to a defective host protein essential for viral infection.

Numerous recessive resistance genes against potyviruses have been identified in the natural diversity of solanaceous crops making this plant family a model for identification of host factors required for viral infection. In pepper (*Capsicum* spp.), several alleles (*pvr1*, *pvr2*¹, *pvr2*², *pvr5* and a major-effect QTL) with distinct spectrum of action were identified at the *pvr2* locus (these alleles are currently carrying distinct names because proofs of allelism were obtained only recently, Ruffel et al. submitted). For example, the *pvr2*¹ allele is effective only against *Potato virus Y* (PVY) strains belonging to pathotype

0, and *pvr2*² controls a complete resistance against PVY pathotypes 0 and 1 and against strains of the *Tobacco etch virus* (TEV). In tomato (*Lycopersicon* spp.), the recessive gene *pot-1* controls both PVY and TEV. The *pot-1* gene was mapped in a genomic region colinear to the region surrounding the *pvr2* locus from pepper, suggesting that *pot-1* is an ortholog of *pvr2* (Parrella et al. 2002).

Results and discussion

pvr2*-mediated resistance is controlled by amino acid substitution in *eIF4E

A 'candidate gene' approach was used to characterize the *pvr2* locus. *eIF4E* was chosen as a putative candidate gene for the *pvr2* function for three main biological features: (i) the resistance-breaking determinants for the *pvr2* and *pot-1* resistance genes localize in the VPg-coding domain (Moury et al. 2004), (ii) *eIF4E* proteins bind with the VPg to *Turnip mosaic virus* (TuMV) and TEV (Leonard et al. 2000; Schaad et al. 2000), and (iii) the interaction between these two proteins is required for virus infectivity (Leonard et al. 2000). Several experiments allowed us to conclude that *pvr2* corresponds to *eIF4E* (Ruffel et al. 2002).

First, a complete map co-segregation between a *eIF4E* gene and the *pvr2* locus was observed in a segregating progeny of 440 plants. Sequence analysis of the cloned *eIF4E* cDNA from pepper revealed that only few amino acid (aa) substitutions distinguish the susceptible (*pvr2*⁺) and resistant (*pvr2*¹ or *pvr2*²) genotypes. Finally, a PVX-mediated transient expression assay was used to validate the role of *eIF4E* into potyvirus resistance. Transient expression of the dominant susceptibility allele (*pvr2*⁺) in resistant pepper plants (*pvr2*¹ or *pvr2*²) leads to PVY or TEV genome amplification in the PVX-infected cells expressing the full length *eIF4E* insert (Ruffel et al. 2002).

To get insight into the role of the aa substitutions, the *eIF4E* cDNA from twenty unrelated pepper genotypes carrying distinct alleles at the *pvr2* locus (*pvr1*, *pvr2*, *pvr5* and the major-effect *QTL pvy4.1*) were sequenced. All the resistance alleles reveal 2 or 3 aa substitutions in comparison with the susceptible allele at positions 51, 66-67, 79, 107-109 and 205. Interestingly, a substitution at position 66 or 67 is conserved for all resistance alleles. Moreover, a strict correlation between the position of the aa substitutions and the resistance phenotype was observed: an aa substitution shared by genotypes that are resistant to TEV (in addition to PVY) and an aa substitution shared by genotypes that are partially resistant to PVY.

***eIF4E*: a target for recessive resistance against potyviruses**

In tomato, we demonstrated that the recessive resistance gene *pot-1* also corresponds to a *eIF4E* gene (Ruffel et al. submitted). The *eIF4E* sequences of susceptible and resistant genotypes differ by six aa substitutions and four of them are precisely localized at the same positions than those observed in pepper (66-67, 79, 107-109, 205). Interestingly, the mutations found in the lettuce *eIF4E* gene conferring resistance against *Lettuce mosaic virus* (LMV) mapped in two regions corresponding to positions 66-67 and 107-109 of the pepper *eIF4E* sequence (Nicaise et al. 2003).

In comparison with the characterization of *Arabidopsis* mutant lines (Duprat et al. 2002), the isolation of natural recessive resistance genes permitted the precise identification of the amino acids involved in the incompatibility between the plant and the virus and showed that only a few number of non-silent mutations are responsible for the resistance phenotype. The role of each mutation in the resistance phenotype, their impact on the activity and/or the conformation of the protein and the correlation between the mutations (alone or in combination) and the associated phenotype remain to be determined.

Possible role of eIF4E proteins in the potyviral replication cycle

The eukaryotic initiation factor 4E, through binding to the 5' cap structure of mRNA, is the first factor that initiates protein synthesis (Figure 1). It is associated with eIF4G to form the eIF4F complex. eIF4G acts as a scaffold for other components of the translation initiation complex such as the eIF4A helicases and the eIF3 multisubunit component. The interaction between eIF4F and the poly(A)-binding protein (PABP) stabilizes the binding of eIF4F to the 5' cap and stimulates the binding of the PABP to the poly(A) tail. This 'protein bridge' between the 5' and 3' ends of mRNA allows its circularization and promotes translation. In plant cells, another complex named eIF(iso)4F was identified and is composed of eIF(iso)4E and eIF(iso)4G. eIF4F and eIF(iso)4F display specialized functions *in vitro*. eIF4F translates efficiently capped mRNAs with an unstructured 5' leader but also mRNAs without a cap-structure or with a highly structured 5'-leader whereas eIF(iso)4F appears to be limited to translation of unstructured capped mRNAs (Gallie and Browning 2001).

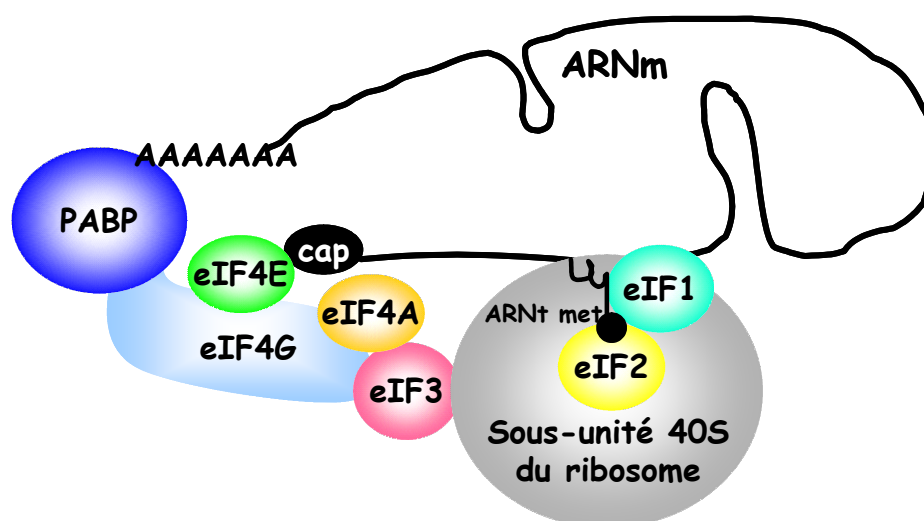

Figure 1: Eukaryotic translation initiation complex.
eIF, eukaryotic initiation factor; PABP, poly(A) binding protein

Potyviral RNA differs from host mRNAs in that the 5' cap structure is replaced by the 5'-covalently-linked VPg and the VPg has been shown to bind to eIF4E in several plant-potyvirus systems (Leonard et al. 2000; Schaad et al. 2000). The VPg may intervene at several steps of the virus infection cycle, including RNA replication, cell- to-cell and long-distance movements (Revers et al. 1999) but the biological significance of the interaction between eIF4E proteins and the VPg remains to be determined. The most likely hypothesis is that interaction is required for translation and/or replication of the viral genome. The involvement of eIF4E in translation of viral RNA seems to be less plausible because translation of potyviruses is cap-independent and conferred by a 5' leader sequence containing internal ribosome entry site (IRES) that recruit eIF4G. The VPg-eIF4E interaction could also be involved in replication. Recently, a model for poliovirus RNA replication (belonging to the super-family of Picorna-like viruses which include potyviruses) have proposed the requirement of the genome circularization through a protein-protein bridge to initiate the negative-strand RNA synthesis (Herold and Andino 2001). According to this model, the PABP, that is able to bind to the poly(A) tail and to the potyviral RNA-dependent RNA polymerase (RDRP), could interact with the eIF4F complex to permit the circularization of the viral RNA. These interactions could bring

the viral RDRP in close proximity of the poly(A) tail and allow the initiation of negative-strand RNA synthesis using the VPg as a primer.

Acknowledgements

This work was supported by grants from GENOPLANTE.

References

- Duprat, A., Caranta, C., Revers, F., Menand, B., Browning, K., Robaglia, C. 2002 :The *Arabidopsis* eukaryotic initiation factor (iso)4E is dispensable for plant growth but required for susceptibility to potyviruses. *Plant Journal* 32: 927-934.
- Gallie, D.R., Browning, K. 2001: eIF4G functionally differs from eIF(iso)4G in promoting internal initiation, cap-independent translation, and translation of structured mRNAs. *J. Biol. Chem.* 276: 36951-36960.
- Herold, J., Andino, P. 2001: Polyovirus RNA replication requires circularization through a protein-protein bridge. *Mol. Cell* 7: 581-591.
- Leonard, S., Plante, D., Wittmann, S., Daigneault, N., Fortin, M., Laliberté, J.F. 2000. Complex formation between potyvirus VPg and translation eukaryotic initiation factor 4E correlates with virus infectivity. *J. Virol.* 74: 7730-7737.
- Nicaise, V., German-Retana, S., Sanjuan, R., Dubrana, M.P., Mazier, M., Maisonneuve, B., Candresse, T., Caranta, C., Legall, O. 2003: The eukaryotic translation initiation factor 4E (eIF4E) controls lettuce susceptibility to the potyvirus *Lettuce mosaic virus*. *Plant Physiol.* 132: 1272-1282.
- Moury, B., Morel, C., Johansen, E., Guilbaud, L., Souche, S., Ayme, V., Caranta, C., Palloix, A., Jacquemond, M. 2004: Mutation in potato virus Y genome-linked protein determine virulence towards monogenic recessive resistances in *Capsicum annuum* and *Lycopersicon hirsutum*. *Mol. Plant-Microb. Interact.* 17: 322-329.
- Parrella, G., Ruffel, S., Moretti, A., Morel, C., Palloix, A., Caranta, C. 2002: Recessive resistance genes against potyviruses are localized in colinear genomic regions of the tomato and pepper genomes. *Theor. Appl. Genet.* 105: 855-861.
- Revers, F., Le Gall, O., Candresse, T., Maule, A. 1999 : New advances in understanding the molecular biology of plant-potyvirus interaction. *Mol. Plant-Microbe Interact.* 12: 367-376.
- Ruffel, S., Dussault, M.H., Palloix, A., Moury, B., Bendahmane, A., Robaglia, C., Caranta, C. 2002. Natural recessive resistance gene against Potato Y potyvirus in pepper corresponds to the eukaryotic initiation factor 4E (eIF4E). *Plant J.* 32: 1067-1075.
- Schaad, M.C., Anderberg, R.J., Carrington, J.C. 2000: Strain-specific interaction of the Tobacco etch NIa protein with the translation initiation factor eIF4E in the yeast two-hybrid system. *Virology* 234: 84-92.

Molecular characterization and genetic variability of Chilli Veinal Mottle Virus and its reaction on chilli pepper genotypes

Krishna Reddy M., Madhavi Reddy K., Lakshminarayana Reddy C. N., Smitha R., Jalali S.

Indian Institute of Horticultural Research, Hessaraghatta Lake PO, Bangalore-560089, INDIA. Contact: mkreddy@vsnl.com, Tel +91.080.28466420

Abstract: Chilli pepper (*Capsicum annum* L) is being grown in diverse climatic conditions throughout India. Non-persistent aphid transmitted viruses have been implicated as the major factor contributing to low yields of chilli pepper in India. A virus causing symptoms of mosaic mottling, vein banding, and leaf distortion of chilli was isolated from chilli growing areas of Karnataka and Tamil Nadu states of India. Of the six isolates collected all of them were identified as Chilli Veinal Mottle Virus (CVMV) based on host range, serological relationship, electron microscopy and phylogenetic analysis of coat protein sequences. The biological differences among the six isolates were noticed in infecting test hosts *Datura metel*, *Nicotiana glutinosa*, *N. tabacum*, and *Capsicum annum*. In order to gain an understanding of the molecular variability present among the six isolates of CVMV, RT-PCR coupled with sequence analysis of coat protein region and 3' non-coding region (NCR) was done. Using primers specific to CP and 3' NTR of CVMV, resulted in a PCR fragments of 0.8 to 1.2 kb depending on primer combinations from all six isolates. Comparison of nucleotide sequences of six isolates with already reported sequences of CVMV, showed 91-93% nucleotide identity. After mechanical inoculation of CVMV isolates on to 25 genotypes of chilli pepper, three genotypes were found immune, 10 genotypes highly resistant, two genotypes resistant and ten genotypes as susceptible as confirmed by symptoms and ELISA testing. The symptom variation and severity varied among six isolates of CVMV.

Keywords: *Capsicum annum*, chilli, chilli veinal mottle virus, CVMV, molecular characterization, RT-PCR, virus resistance

Introduction

Chilli pepper (*Capsicum annum* L.) is an important vegetable crop of India grown extensively over an area of 0.956 m. ha with an annual production of 0.945 m. t. (Peter, 1999). Virus diseases cause serious losses in chilli and become the most limiting factors affecting chilli production. Of the several viruses reported from India (Ramakrishnan, 1961, Green and Kim, 1991, Joseph and Savithri, 1999), *Chilli veinal mottle virus* (CVMV) is the most important virus of chilli pepper through out the country (Krishnareddy *et al.*, 2001).

Chilli veinal mottle virus (CVMV) is flexuous filamentous particle and a member of the *potyvirus* genus, is endemic virus in hot pepper mainly in Asian countries (Green and Kim, 1991). It is readily sap transmissible to a narrow range of hosts and is transmitted by aphid in a non persistent manner. A virus causing symptoms of mosaic mottling, vein banding, and leaf distortion of chilli was isolated from chilli growing areas of Karnataka and Tamil Nadu states of India.

In order to gain an understanding of the variability present among the CVMV isolates in India, RT-PCR technique coupled with sequence analysis and reaction of CVMV isolates on different genotypes of chilli pepper were studied.

Materials and Methods

Sample collection and virus isolates

Survey was conducted during 2002 and 2003 in chilli growing areas of Karnataka and Tamil Nadu states of India. Leaf samples of chilli plants exhibiting virus like symptoms were collected at random and samples were kept in ice chest for transportation to the laboratory. All the samples were tested by ELISA using polyclonal antibodies of CVMV and positive samples are inoculated to a range of diagnostic hosts. The isolates used are BCV3 (Bangalore, Karnataka), BeCV3 (Bellary, Karnataka), CCV1, CCV2 (Coimbatore, Tamil Nadu), DCV1 (Dharwad, Karnataka), DCV4 (Sherwad, Karnataka) and these isolates are used for all the experiments.

Reaction of chilli lines to CVMV isolates

The reaction of chilli lines (40 to 50 seedlings/ line) to CVMV was evaluated by inoculating 3 weeks old chilli plants. The sap from infected leaves of each CVMV isolate was extracted using 0.1M phosphate buffer (pH 7.0) along with celite and was rubbed on leaves of host plants. The plants were rinsed with water for 5 min. after rubbing and were allowed to grow in the green house for symptom recording. Resistance was assessed by scoring the lines for symptoms, percent infection of plants and A 405 absorbance values. Based on these observations the lines were grouped as immune, highly resistant (HR), resistant (R), susceptible (S) and highly susceptible (HS). The presence of virus was confirmed by ELISA at two, five, and eight weeks after inoculation.

Molecular characterization of 3' terminal region genome of CVMV

For molecular identification of strains of CVMV, the viral RNAs were extracted by Rneasy plant mini kit (Qiagen, USA) and amplified by reverse transcription – Polymerase chain reaction (RT-PCR) using two sets of primers: primer pair oligo (dT)/ CVMV 1037, which amplifies the coat protein and the 3' end non translated region (NTR) and second primer pair oligo(dT)/ poty3, which amplifies part of the coat protein and the 3' end NTR. PCR amplified products were excised from the agarose gel and DNA was extracted using the gel extraction kit (Qiagen, USA). The fragments were T/A cloned into pTZ vector (MBI Fermentas). PCR derived clones were used to determine the nucleotide sequences, using the sequencing facility of Avastha Gen Graine Technologies Pvt. Ltd (Bangalore, India). Multiple alignments of nucleotide sequences were obtained using the CLUSTAL X program.

Results and Discussion

The biological differentiation of CVMV isolates based on infection and symptom expression indicated that all the six isolates varied in their reaction pattern on differential hosts. None of the isolates infects cucumber and all the isolates infect systematically *N. glutinosa*, *N. tabaccum* and *Datura metel* (Table 1).

Mechanical inoculation of CVMV on 25 chilli pepper genotypes resulted in symptom less infection to severe symptoms of mosaic and leaf distortion. Based on disease intensity and ELISA OD values all the lines are classified into five groups (Table 2). Three lines C00265, AR28/98K and PBC371 were found to be immune to all the isolates of CVMV which are useful for developing disease resistant varieties and hybrids. Ten lines were reacted immune to resistant reaction, where as two lines showed resistant to susceptible reaction to different isolates of CVMV. The remaining ten lines are highly susceptible to different isolates. Identification of stable resistance source to several isolates of CVMV is useful for breeding program and the identified sources also need to

be evaluated for more isolates of CVMV so that the specificity of resistance can be defined.

The primer pair oligo (dT)/ CVMV-1037 produced a PCR fragment of 1.2kb DNA (Figure 1) from CCV1 and DCV1 isolates but not from BCV3, BeCV3, CCV2 and DCV4 isolates of CVMV. CCV1 and CCV2 isolates both were collected from same place, however PCR amplification indicated differences in these two isolates. Failure of amplification of this primer set clearly indicates the isolates have differences at Nib 3' end region of CVMV. The second pair of primers oligo (dT)/ poty 3 amplified a PCR product of 0.8 kb DNA fragment from all the isolates (Figure 1).

PCR products were cloned into pTZ vector and sequenced. Nucleotide sequence alignments obtained were presented in Figure 2. Each sequence includes the part of CP gene flanked by the last 287 nucleotides of the 3' NTR region. Only 32 nucleotide sequence differences are localized at 3' NTR region, whereas in the CP region 61 nucleotide differences exists in different isolates. These sequences were also compared to other isolates of CVMV retrieved from the Gene Bank database. The highest percentage of homology (92-93 %) was obtained with pepper vein banding virus and chilli veinal mottle virus, a widely distributed potyviruses in India (Joseph and Savithri, 1999; Chiemsoombat *et al.* 1998), while lower homology 79 to 84% is noticed with PVY, PeSMV, PVMV and TEV which are other potyviruses infecting peppers.

The biological characterization and hot pepper genotype reaction is not in line with the cp gene and NTR sequence analysis as sequence variability was not correlated with host reactions. This behavior has been also observed in other potyviruses such as PVY isolates reaction on tobacco and potato is not correlated with molecular classification based on 3' region PVMV reaction on tomato and pepper (Chachulska *et al.* 1997, Gorsane *et al.* 2001, Kerlan *et al.*, 1999).

Considering sequences of cp gene, CVMV isolates are more closely related to each other molecularly, regardless of symptoms. However, the reaction pattern of different genotypes indicates differences in the isolates. These conclusions however, further confirmed by analysis of complete genome of a large number of CVMV strains.

Acknowledgements

We thank Department of Biotechnology, Ministry of Science and Technology, India for funding the research work.

References

- Chachulska, A. M. Chzanowsks, M. Robaglia, C. & Zagorski, W. 1997: Tobacco veinal necrosis determinants are unlikely to be located within the 5' and 3' terminal sequences of the potato virus Y genome. *Arch. Virol.*, 142: 765-779.
- Chiesmsombat, P. Sae-Ung, N. Attathom, S. Patarapuwadol, S. & Siritwong, P. 1998: Molecular taxonomy of a new potyvirus isolated from chilli pepper in Thailand. *Arch. Virol.*, 143: 1855-1893.
- Green, S.K. & Kim, J.S. 1991: Characteristics and control of viruses infecting peppers: a literature review. AVRDC Technical. Bull., 18: 60pp.
- Gorsane, F. Fakhfakh, H. Tourneur, C. Marrakchi, M. & Makni, M. 2001: Nucleotide sequence comparison of the 3' terminal region of the genome of pepper veinal mottle virus isolates from Tunisia and Ivory Coast. *Arch. Virol.*, 146: 611-618.
- Joseph, J. & Savithri, H.S. 1999: Determination of 3'- terminal nucleotide sequence of pepper vein banding virus RNA and expression of its coat protein in *Escherichia coli*. *Arch. Virol.*, 144: 1679-1687.

- Kerlan, C. Tribodet, M. Glais, L. & Guillet, M. 1999 :Variability of potato virus Y in potato crops in France. *J. Phytopathology*, 147:643-651.
- Krishnareddy, M. Sadashiva, A.T. Madhavi Reddy, K. Celia Chalam, Deshpande, A.A. & Jagadish Chandra, K. 2001: Leaf curl and other viruses of tomato and peppers, pp.28-33. In: SAVERNET Phase II proc. Final Workshop, AVRDC, Bangkok, Thailand.
- Peter, K.V. 1999: Spices - making of a global leader. *The Hindu, Survey of Indian Agriculture*, 83p.
- Ramakrishnan, K. 1961: Virus diseases of pepper (*Capsicum spp.*). *J. Indian Bot. Soc.*, 40: 12-46.

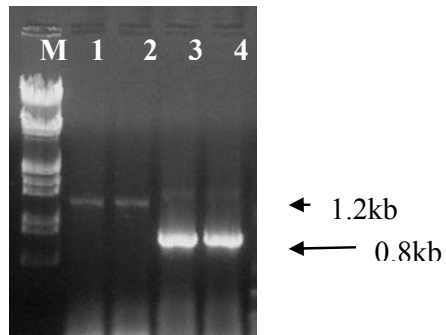

M:DNA marker (Lambda DNA HindIII + EcoRI digest), Lane 1-DCV1, 2-DCV4, 3.BCV3, 4-BeCV3

Table 2. Reaction of chilli pepper genotypes to different isolates of CVMV

Capsicum lines	BCV3		BeCV3		CCV1		CCV2		DCV1		DCV4	
	% DI	R	% DI	R	% DI	R	% DI	R	% DI	R	% DI	R
1. C00265	0.0	I	0.0	I	0.0	I	0.0	I	0.0	I	0.0	I
2. PBC371	0.0	I	0.0	I	0.0	I	0.0	I	0.0	I	0.0	I
3. AR28/98K	0.0	I	0.0	I	0.0	I	0.0	I	0.0	I	0.0	I
4.VC240	0.0	I	0.0	I	0.0	I	0.0	I	0.0	I	3.3	HR
5.IHR28	0.0	I	0.0	I	0.0	I	0.0	I	4.2	HR	3.9	HR
6.Pusa Sadabahar	0.0	I	0.0	I	0.0	I	2.2	HR	0.0	I	4.4	HR
7.PBC521	28.5	R	0.0	I	0.0	I	4.2	HR	0.0	I	17.8	R
8. VC241	0.0	I	0.0	I	11.1	R	0.0	I	10.0	HR	14.8	R
9.PBC136	0.0	I	6.8	HR	9.7	HR	10.7	R	0.0	I	12.9	R
10. VC58	0.0	I	17.2	R	0.0	I	7.1	HR	0.0	I	11.1	R
11.PBC569	0.0	I	6.9	HR	7.4	HR	9.7	HR	8.0	HR	9.5	HR
12.Punjab Surkh	0.0	I	6.4	HR	0.0	I	10.7	HR	12.0	R	14.3	R
13. IHR3	6.6	HR	12.0	R	8.3	HR	17.8	R	19.2	R	26.9	R
14.IHR10	15.8	R	31.0	R	20.6	R	44.0	S	9.7	HR	46.1	S
15.IHR15	20.0	R	51.6	HS	36.0	R	48.1	S	45.8	S	64.0	HS
16.IHR23	48.3	S	50.6	HS	46.1	S	67.7	HS	48.4	S	61.2	HS
17.IHR26	76.9	HS	80.0	HS	43.7	S	74.1	HS	87.0	HS	100	HS
18.IHR18	100	HS	89.5	HS	96.6	HS	80.6	HS	76.6	HS	100	HS
19.VC27	65.6	HS	88.6	HS	74.3	HS	100	HS	80.8	HS	100	HS
20.IHR25	90.6	HS	84.3	HS	93.5	HS	100	HS	90.3	HS	100	HS
21.IHR29	80.0	HS	100	HS	81.7	HS	82.8	HS	67.8	HS	71.4	HS
22.IHR31	82.7	HS	100	HS	62.5	HS	100	HS	68.0	HS	100	HS
23. IHR32	100	HS	100	HS	89.5	HS	100	HS	78.1	HS	100	HS
24. Arka Abhir	100	HS	100	HS	100	HS	100	HS	100	HS	100	HS
25. Arka Lohit	100	HS	100	HS	100	HS	100	HS	100	HS	100	HS

DI: Disease intensity, I: Immune- no infection and ELISA negative, HR: Highly resistant- 0.1 to 10% infection and ELISA OD values 0.110 to 0.300, R: Resistant- 11 to 25% infection and ELISA OD values 0.301 to 0.500 S: Susceptible- 25 to 50% infection and ELISA OD values 0.510 to 1.00 HS: Highly susceptible – more than 50% infection and ELISA OD values more than 1.00

Table 1. Biological characterization of CVMV isolates

Differential hosts	BCV3		BeCV3		CCV1		CCV2		DCV1		DCV4	
	L	S	L	S	L	S	L	S	L	S	L	S
1. <i>Cucumis sativus</i> cv. Green Long	-	-	-	-	-	-	-	-	-	-	-	-
2. <i>Datura metal</i>	-	M, Ld	NL L	M, Ld	-	M, Ld	NL L	M, Ld	-	M, Ld	NL L	M, Ld
3. <i>Nicotiana glutinosa</i>	-	Mo	-	Mo	-	Mo	-	Mo	-	Mo	CL L	Mo
4. <i>N. tabacum</i> cv. White Burley	-	SNL	NL L	SN	-	SNL	NL L	SN	-	SNL	NL L	SN
5. <i>Capsicum annum</i> cv. Arka Lohit	-	M,Vb	CL L	M,Vb	-	M,Vb	CL L	M,Vb	-	M,Vb	-	M,Vb
cv. VC 16	-	-	-	-	CL L	M, Vb	-	M,Vb	-	-	-	-
cv. VC 31	-	M,Vb	-	M,Vb	-	-	-	M,Vb	-	-	-	M, Vb

CLL=Chlorotic local lesions; L: Local symptoms; NLL= Necrotic local lesions; M=Mosaic; Mo=Mottling; Ld=Leaf distortion; S: Systemic symptoms; SN=Systemic necrosis; SNL= Systemic necrotic lesions

	405	415	425	435	445	455	465	475	485	495
Thai	GCACACAGGA	GGAGGACACC	GAACGCCATA	CAGCAGAGGA	TGTGAATAGA	AATATGCACA	ACTTGCTGGG	TGTTTCGTGGA	TTGTAACATC	TTCAGCTTTT
BCV3	-C-----	A-----	-----G-C-	---G-----	-----	--C-----T-	-TC-----	CT---A--G	T---G-***A-	---A-----
DCV1	-C-----	A-----	-----G-C-	---A-----	-----	--C-----T-	-CC-----	CG---A--A	T---G-***A-	---A-----
DCV4	-C-----	A-----	-----G-C-	---A-----	-----	--C-----T-	-CC-----	CG---A--A	T---G-***A-	---A-----
CCV2	-C-----	A-----	-----G-C-	---A-----	-----	--C-----T-	-CC-----	CG---A--A	T---G-***A-	---A-----
CCV1	-C-----	A-----	-----G-C-	---A-----	-----	--C-----T-	-CC-----	CG---A--A	T---G-***A-	---A-----
BeCV3	-A-----	A-----	-----G-C-	---A-----	-----	--C-----C-	-CC-----	CG---A--G	C---GA***A-	---A-----
Clusta	* ****	*****	***** * *	**** *****	*****	** ***** *	*****	**** *	**** *	**** *****

	505	515	525	535	545	555	565	575	585	595
Thai	AACTAGTAGT	AAATAACATA	TTGTAGTATA	TGTA*ACTTG	GTTTATGTTG	TTGATCATA	ATATTCTTCA	GTGTGGATCC	CACCATAAGT	TATGTGTGCT
BCV3	-----A-	A-A-----	-----	---*A---	-----	-----C-TA-	-----	-----C---	-----	-----G---
DCV1	-----A-	A-G-----	-----	---*A---	-----	-----T-CA-	-----	-----C---	-----	-----G---
DCV4	-----A-	A-G-----	-----	---*A---	-----	-----T-CA-	-----	-----C---	-----	-----G---
CCV2	-----A-	A-G-----	-----	---AC---	-----	-----T-CA-	-----	-----C---	-----	-----G---
CCV1	-----A-	A-G-----	-----	---AC---	-----	-----T-CA-	-----	-----C---	-----	-----G---
BeCV3	-----G-	G-G-----	-----	---*C---	-----	-----C-TG-	-----	-----T---	-----	-----A---
Clusta	***** *	* *****	*****	**** *****	*****	***** *	*****	***** **	*****	***** *****

	605	615	625	635	645	655	665	675	685	695
Thai	TGACCTCATA	CTACTTTATA	TATATGTTAT	TTAATGCTTT	TTATCTAGGT	AACTGTGTAC	CCCCGCCCAT	TCTAGCGTGG	TTCCACCTT	AATAGAATGG
BCV3	-AA-T-----	-----T---	-----	---G-A---	-----T---	-----C---	-----A---	TT-----	-----C---	---A---T---
DCV1	-AA-T-----	-----G---	-----	---G-A---	-----T---	-----T---	-----G---	TC-----	-----C---	---G---C---
DCV4	-AA-T-----	-----G---	-----	---G-A---	-----T---	-----T---	-----G---	TC-----	-----C---	---G---C---
CCV2	-AA-T-----	-----G---	-----	---G-A---	-----T---	-----T---	-----G---	TC-----	-----A---	---G---C---
CCV1	-AA-T-----	-----G---	-----	---G-A---	-----T---	-----T---	-----G---	TC-----	-----A---	---G---C---
BeCV3	-GG-T-----	-----T---	-----	---G-A---	-----T---	-----C---	-----A---	TC-----	-----A---	---A---T---
Clusta	* * *****	***** **	*****	*** * *****	*****	*****	***** *	* *****	***** **	*** ** *

	705	715	725	735	745	755	765
Thai	AGCAACAAAG	ACTATTGTTA	TGG*TTTACG	GAGGTGACTC	TGTGGGTCGG	TGAGCTGTTC	AATAGTTGGC
BCV3	T-----	-----	---*---A-	-----	-G-----T	-A-A---T--	A-----
DCV1	T-----	-----	---*---A-	-----	-T-----T	-A-A---T--	G-----
DCV4	T-----	-----	---*---A-	-----	-T-----T	-A-A---T--	G-----
CCV2	T-----	-----	---G---A-	-----	-T-----T	-A-A---T--	G-----
CCV1	T-----	-----	---G---A-	-----	-T-----T	-A-A---T--	G-----
BeCV3	T-----	-----	---G---A-	-----	-G-----T	-A-G---G--	A-----
Clusta	*****	*****	*** *****	*****	* *****	* * * * *	*****

Improvement of eggplants for resistance to *Verticillium*

Acciarri N.¹, Rotino G.L.², Sabatini E.¹, Valentino D.³, Sunseri F.⁴, Mennella G.^{5,6}, Tamietti G.³

¹Istituto Sperimentale Orticoltura, 63030 Monsampolo del Tronto (AP), Italy. ²Istituto Sperimentale Orticoltura, Via Paulllese 28 26836 Montanaso L. (LO), Italy. ³DI.VA.P.R.A, Università di Torino, via Leonardo da Vinci 44, 10095 Grugliasco (TO), Italy. ⁴Dip. Bi.Di.B.A.F., Università della Basilicata, C.da Macchia Romana 85100 Potenza, Italy. ⁵Istituto Sperimentale Orticoltura, P.O. BOX 48 84098 Pontecagnano (SA), Italy. ⁶Email: peppemennella@libero.it .

Verticillium wilt of eggplant, caused by *Verticillium dahliae* Kleb, is one of the most serious diseases in tropical and temperate areas and it is an important limiting factor in the production of the crop. Resistance/tolerance to the wilt varies among eggplant cultivars. Some cultivars have been used as sources of resistance in breeding programs but none has sufficiently high resistance under field conditions. Some wild relatives of eggplant have been considered as possible source of resistance. In this study *Solanum sodomium* L. (2n=24) was used as source of resistance. Interspecific hybrids were successfully obtained only when *S. sodomium* was used as female parent. The interspecific hybrids were both selfed and backcrossed using different eggplant genotypes in order to obtain lines with an improved tolerance to *V. dahliae*. After 3-4 cycles of backcrosses and selfing, improved features of fruits and plants were obtained. The selection for resistance to *Verticillium* wilt, mainly based on the response to naturally infested soil with, is in progress and allowed the improvement of the tolerance to the disease.

Infection of Chili Veinal Mottle Virus(ChiVMV) is not affected by temperature

M.C. Cho^{1,2} · S. C. Shieh³ · P.A. Gniffke³ · S. K. Green³ · D.H. Pae³

¹ *National Horticultural Research Institute, RDA, Suwon, 441-440, Korea.* ² *Email: chomc@rda.go.kr.* ³ *Asian Vegetable Research and Development Center, Tainan, Taiwan 741.*

The effect of different temperature regimes (low : day 24°C, night 17°C; medium : day 28°C, night 21°C; high : day 32°C, night 25°C) on the infectivity and symptoms caused by chilli veinal mottle virus (ChiVMV) were investigated in 4 accessions and one breeding lines of *Capsicum annuum*. The percentage of infected plants (positive reaction in ELISA) of the susceptible accession VC 27a was 100% at each of the temperature regimes tested. Symptoms of accession VC 37a infected by ChiVMV varied with the different temperature regimes. At medium (28/21°C) temperature, plants of VC 37a showed severe mosaic symptoms, whereas at low (24/17°C) and high (32/25°C) temperatures infected plants of this accession showed systemic necrosis and/or mild mosaic symptoms. Resistant check varieties 0137-7002 (HDA 249) and PBC 495 (Perennial) both displayed high levels of resistance under all temperature treatments. A line with intermediate level of resistance (VC 37a) displayed a higher infection rate at low temperature treatment.

Genetic, cytological and molecular bases of the resistance to root-knot nematodes (*Meloidogyne* spp.) in pepper (*Capsicum annuum* L.)

Djian-Caporalino C.⁽¹⁾, Berthou F.⁽²⁾, Fazari A.⁽¹⁾, Lefebvre V.⁽³⁾, Palloix A.⁽³⁾, Pegard A.⁽¹⁾, Pijarowski L.⁽¹⁾

⁽¹⁾ INRA, Unité Interactions Plantes Microorganismes et Santé Végétale, B.P. 2078, 06600 Antibes cedex, France

⁽²⁾ INRA, Unité de Biologie des organismes et des populations appliquée à la protection des plantes, BP 35327, 35653 Le Rheu cedex, France

⁽³⁾ INRA, Unité de Génétique et Amélioration des Fruits et Légumes, B.P. 94, 84143 Montfavet cedex, France

(EU-project QLRT-1999-1462 "DREAM", [http : //www.ipodlo.nl/ ipowww/dream/](http://www.ipodlo.nl/ipowww/dream/))

Abstract: In pepper, researches on genetic basis of root-knot nematode resistance were conducted on three genetically distant accessions: PM687 (PI 322719), PM217 (PI 201234) and PM702 (Criollo de Morelos 334). They revealed three dominant and thermostable loci with broad-spectrum of resistance: *Me3*, *Me1* and *Me7* (against *Meloidogyne incognita*, *M. arenaria* and *M. javanica*) and two other loci: *Mech1* (PM217) and *Mech2* (CM334) controlling the quarantine nematode *M. chitwoodi*. Comparative histological studies showed that the three broad-spectrum resistance genes suppressed nematode reproduction, but induced very different response patterns in root cells upon nematode infection according to the pepper lines and to the nematodes. Bulk-segregant analysis was performed to identify AFLP markers linked to the genes. Fine mapping of *Me3* (PM687) previously gave AFLP less than 0.5 cM flanking the gene (Djian-Caporalino et al, TAG 2001). Fine mapping of the other genes gave flanking AFLP markers linked in coupling to the resistance genes (the nearest were located less than 2 cM from *Mech1*, 3 cM from *Me1* and 10 cM from *Mech2*) and indicated that the genes were linked. Allelism tests completed this year on F3 progenies revealed that the genes are effectively different but linked, percentage of recombination being estimated between 10% and 25% according to the genes. Indirect selection markers (SCAR or SSCP) were identified. Some of them have been mapped on the intraspecific pepper maps developed in INRA Avignon. They were assigned to chromosome P9. We had previously located *Me3* on the same chromosome. So we may suppose a cluster of resistance genes to *Meloidogyne* spp. (*Me3*, *Me1*, *Me7*, *Mech1*, *Mech2*) on pepper chromosome P9. We also previously investigated map position homologies between resistance genes in Solanaceae crops. *Me3* maps in a syntenic region with 3 other nematode resistance genes, *Mi-3*, *Mi-5* and *Gpa2*, which map in the telomeric region of the short arm of the tomato and potato chromosome 12 (Djian-Caporalino et al, TAG 2001). Blast realised with all the markers in Genbank (Infobiogen) revealed that there was no homology with known gene sequences for all of them but 96% homology between one AFLP and a sequence in *Bs2* gene (in NBS conserved region). This gene confers resistance to bacterial pathogen *Xanthomonas campestris* pv. *vesicatoria*. PCR-specific markers have been then defined in the NBS and LRR conserved regions of the *Bs2* gene in order to obtain other specific markers of the genes.

Evaluation of differential interactions between *Phytophthora capsici* Leonian isolates and some pepper (*Capsicum annuum* L.) genotypes

Gocmen M., *Cakir C., **Abak K

Citrus and Greenhouse Research Institute, P.O. 35, Antalya, Turkey

Tel: 00 90 242 321 67 96, Fax:00 90 242 321 15 12, mgocmen94@yahoo.com

**Akdeniz University, Agriculture Faculty, Plant Protection Department, Antalya, Turkey, cahit@agric.akdeniz.edu.tr*

***Cukurova University, Agriculture Faculty, Horticultural Department, Adana, Turkey, abak@mail.cu.edu.tr*

Abstract *Phytophthora capsici* Leon. is one of the most destructive soilborne pathogens and has a wide host range. In this study, eight pepper genotypes (KMAE-12, KMAE-390, KM2-11-1, PM-702, CMM-334, PM-178, PM-1364, Perennial,) were challenged with nine isolates of *P. capsici* (four isolates obtained from pepper in the various locations of Antalya region, four isolates from Maras region (the most important production center of pepper in Turkey) in Turkey and one isolate from USA was evaluated by using stem wounding method under controlled environmental conditions. Four different criteria were used to evaluate the resistance corresponding to different steps or mechanisms to the host – pathogen interaction: receptivity, inducibility, stability and final necrosis length. Significant differences were observed in the reaction of genotypes to isolates. Some genotypes (CMM-334, PM-702, PBC-178, PBC-1364, KM2-11-1, and Perennial) were found resistance to all tested isolates while KMAE-12 and KMAE-390 were found susceptible to some isolates.

Typing of tomato yellow leaf curl virus spreading on pepper in Tunisia

**F. Gorsane^{1,3}, I. Fekih-Hassen¹, S. Gharsallah-Chouchene¹, M.K. Nakhla², D. P. Maxwell²
M. Marrakchi¹ and H.Fakhfakh^{1,3}**

¹*Laboratoire de Génétique Moléculaire, Immunologie et Biotechnologie, Faculté des Sciences de Tunis, Campus Universitaire, 2092, ElManar, Tunis, Tunisie.* ²*Department of Plant Pathology, University of Wisconsin-Madison, Madison, w1 53706, USA.* ³*Faculté des Sciences de Bizerte, Tunisie. Email: Faten.gorsane@fss.rnu.tn*

Tomato Yellow Leaf Curl Virus complex (TYLCV) is an economically important group of pathogens of field-grown pepper, tomato and recently bean cultivars in many parts of the world. In Tunisia, pepper, the most commonly cultivated Solanacea, is exhibiting unusual symptoms ranging from yellowing, mosaic, crumpling and plant size reduction. These diseases, which may be associated with the TYLCV, have become increasingly prevalent in recent years. In order to provide molecular characteristics of TYLCV Tunisian isolates, both coat protein gene and the intergenic region of pepper isolates were amplified in PCR procedures using specific primers and submitted to direct sequencing. Phylogenetic analysis suggested their clustering with a Sicilian isolate of TYLCSV-Sic. The genetic diversity of Tunisian TYLCV between pepper, tomato and bean isolates is also examined.

Determination of the inheritance of resistance to bacterial wilt (*Ralstonia solanacearum*) in eggplant (*Solanum melongena* L.)

Gousset C¹, Lian Yong², Mariska I³, Rotino G⁴, Seaves A¹, Sihachakr D¹

¹*Ecologie, Systématique, Evolution, Bât. 360 Université Paris Sud, 91405 Orsay Cedex,*

France; dara.sihachakr@ese.u-psud.fr; ²*Institute of Vegetables and Flowers, Chinese Academy of Agricultural Science (CAAS), 30 Baishiqiao road, 100081 Beijing, China;*

³*Reserach Institute for Food Crop Biotechnology, JL Tentara Pelajar N°3A, 16116 Bogor, Indonesia;* ⁴*Istituto Sperimentale per l'Orticultura, via Pauledese 28, 26836 Montanaso Lombardo, Italy*

Trait of resistance to bacterial wilt, caused by *Ralstonia solanacearum*, was identified in *Solanum aethiopicum* and few Chinese eggplant landraces (*S. melongena*). In view of genetic analysis of bacterial resistance, sexual hybridisation was performed between resistant and susceptible Chinese eggplant landraces, followed by selfing the resulted F1 progeny to produce F2 lines. Likewise, fertile tetraploid somatic hybrids of eggplant with one of its wild relatives, *S. aethiopicum*, were obtained, and their anthers were cultured to produce dihaploids. The resulted dihaploids with bacterial resistance were backcrossed to a susceptible recurrent eggplant for production of BC lines, which were subjected to genetic analysis.

Twenty-one F1 lines were checked for bacterial resistance by artificial inoculation. The response of F1 lines to *R. solanacearum* showed the complexity of the inheritance of bacterial resistance in eggplant. It was not homogeneous, but varied from high resistance to susceptibility. Traits of resistance could be either dominant or recessive, depending on the genotypes used. Interestingly, reciprocal crosses between some genotypes of Chinese eggplant landraces seemed to indicate that resistance could not be mendelian but depended on cytoplasmic factor. In fact, 3 F1 lines were found resistant, while 11 were all susceptible. An intermediate response was also found in 3 F1 lines. Moreover, reciprocal crossings revealed a non-mendelian inheritance of the resistance trait in the remaining F1 lines tested. Preliminary genetic analysis of most F2 progenies from selfing resistant F1 lines, did not reveal any simple segregation of bacterial resistance. However, few F2 lines seemed to show 50% resistant plants, suggesting a possible dominant gene involved in bacterial resistance in eggplant.

Among the BC lines tested for bacterial resistance, a few seemed to show a simple segregation for trait of resistance against *R. solanacearum*. Interestingly, two BC lines seemed to reveal about 50% of plants being resistant to bacterial wilt, suggesting a possible dominant gene involved in resistance to bacterial wilt in *S. eathiopicum*.

Work is in progress for further genetic analysis and identification of molecular markers linked to bacterial resistance in eggplant and *S. aethiopicum*.

This work is supported by a grant from European Union (contract N° ICA4-CT-2001-10064)

High levels of resistance to bacterial (*Ralstonia solanacearum*) and fungal (*Fusarium oxysporum*) wilts and genetic homogeneity in Indonesian accessions of *Solanum torvum*, a wild relative of eggplant

Gousset C¹, Karden M², Mariska I², Rotino G³, Servaes A¹, Sihachakr D¹

¹Ecologie, Systématique, Evolution, Bât. 360, Université Paris Sud, 91405 Orsay Cedex, France; dara.sishachakr@ese.u-psud.fr; ²Research Institute for Food Crop Biotechnology, JL Tentara Pelajar N° 3A, 16111 Bogor, Indonesia; ³Istituto Sperimentale per l'Horticultura, via Pausanias 28, 26836 Montanaso Lombardo, Italy

In view of their exploitation in eggplant breeding programs, 28 accessions of *Solanum torvum*, a wild relative of eggplant, were collected in Java – Indonesia, and subjected to evaluation of fertility and resistance against bacterial (*Ralstonia solanacearum*) and fungal (*Fusarium oxysporum*) wilts. Moreover, they were characterised morphologically and molecularly.

No significant difference was found among the accessions for the diameter of stem and the number of branches, while the length of branches and internodes were significantly different between the accessions. Although the leaf shape and form varied with the genotype, the leaf length remained relatively homogeneous, ranging from 20.3 to 20.6 cm. Flower characteristics generally showed significant difference among the accessions, except the length of calyx and pistil. The percentage of fruit setting was not significantly different among the accessions, while the number of inflorescences, and the number and weight of fruits significantly varied with the accession.

When inoculated with *R. solanacearum*, race 1 biovar 3 strain, no wilted plants were observed irrespective of the accessions of *S. torvum*. However, some of them showed few wilted leaves in the lower stem, suggesting that the levels of resistance against *R. solanacearum* could vary with the genotype. Among the 28 accessions tested, 12 had no wilted leaves at all. By using serological assays, latent bacterial colonisation in symptomless plants was however demonstrated, mainly in roots and/or lower stem, indicating that *S. torvum* can be considered as tolerant to *R. solanacearum*, race 1 biovar 3 strain. Likewise, all the accessions of *S. torvum* tested were found completely resistant to Italian strain of *Fusarium oxysporum* f.sp. *melongenae*, as they survived to the pathogen without any wilted leaves.

The homogeneity between accessions regarding high tolerance to bacterial and fungal wilts was also extended to molecular characterisation. In fact, out of 20 RAPD primers tested, 6 revealed a polymorphic locus. Likewise, among 100 ISSR (Inter Simple Sequence Repeat) markers tested, only one generated polymorphism. A complete lack of polymorphism was observed among the accessions of *S. torvum*, when analysed by using 30 couples of REMAP (Retrotransposon-Microsatellite Amplified Polymorphism) markers. This reduced genetic variation, together with a homogeneous response in resistance to bacterial and fungal wilts, is generally expected in an autogamous species, like *S. torvum* with a narrow genetic background, which was probably introduced on Indonesian Islands.

This work is supported by a grant from European Union (contract N° ICA4-CT-2001-10064)

Evaluation of phytophthora and ralstonia multiple resistance selections of pepper for adaptability as rootstocks

B.S. Kim and J.H. Kim.

College of Agriculture and Life Science, Department of Horticulture, Kyungpook National University, Daegu 702-701, Korea. E-mail: bskim@knu.ac.kr

Selections derived from crosses between Phytophthora resistant CM334 and AC2258 (Line 29) or PI201234 and bacterial wilt resistant PBC631 and MC4 were evaluated for resistance to bacterial wilt and *Phytophthora capsici* at seedling stage. The selected plants were transplanted to a greenhouse and further selected for the resistance and viral complex. A set of promising lines of them were preliminarily evaluated for adaptability as rootstocks in comparison with a commercial hybrid rootstock cultivar, Tantan in a farmer's greenhouse field during 2002-2003 winter and spring crop. Our breeding lines were satisfactory in resistance to the diseases but inferior the commercial control in ability to support growth of scion plants under low temperature condition. Therefore, incorporation of ability to grow vigorous under low temperature would be necessary.

Reaction of different *Capsicum* genotypes to Tobamoviruses and *Cucumber mosaic virus*

J. Kovács¹, R. Gáborjányi¹, J. Horváth¹, G. Kazinczi² and A.P. Takács²

¹University of Veszprém, Georgikon Faculty of Agricultural Sciences, P.O. Box 71, H-8361 Keszthely, Hungary. Email: gr@georgikon.hu

²Office for Academy Research Groups Attached to Universities and Other Institutions, Virological Group, University of Veszprém, Georgikon Faculty of Agricultural Sciences, H-8361 Keszthely, P.O.Box 71. Hungary

The objective of this study was to examine the reaction of 29 *Capsicum* genotypes to common strain of *Tobacco mosaic virus* (TMV-C/U1), *Obuda pepper virus* (ObPV) and legume strain of *Cucumber mosaic virus* (CMV-U/246). Mechanically inoculated plants were symptomatologically tested for infections. Five weeks after inoculation the infected plants were tested by direct double-antibody sandwich ELISA (DAS ELISA) method. Test samples were considered susceptible to viruses if their extinction values exceeded three times than those of the healthy control ones. In order to confirm the results of symptomatology and serology, back inoculations were also carried out to *Nicotiana glutinosa*, *N. tabacum* 'Xanthine' and *N. tabacum* 'Samsun'. Among the tested 14 *Capsicum* genotypes one (VI-13=13/96 ii) to TMV-C/U1, and one [VI-91 (179) 47/87] to ObPV showed resistance. Neither local nor systemic symptoms on inoculated plants could be observed and results of DAS ELISA and back inoculation were also negative. Six genotypes [XII-a=542, XII-a=543, XII-a=407 French Perennial, XII-a=9/99 F₁ x (RR DH x 412/a CMVR), XII-a=15/99 F₁ x (413 x R12 DH x R KDH) BC₁ F₁, XII-a=4/99 F₂] were resistant to CMV-U/246. These genotypes could be used for resistance breeding to viruses.

Diseases of pepper in Serbia and results of breeding for resistance

M. Mijatovic¹, B. Zecevic¹, D. Cvikic¹ and A. Obradovic²

¹ Centre for Vegetable Crops, Karadjordjeva St. 71, 11420 Smederevska Palanka, SCG, info@cvcsp.co.yu

² Pesticide and Environment Research Centre, Banatska 31b, 11080 Zemun, SCG

Pepper is one of the major vegetable crops grown in Serbia. According to the total area planted with pepper for fresh market, Serbia is among leading countries in Europe. However, pepper diseases, causing significant yield losses, are one of the limiting factors of successful production. Seedling damping-off, caused by soil-borne fungi *Rhizoctonia* spp., *Pythium* spp., *Phytophthora* spp., and *Fusarium* spp. occurs frequently in pepper transplant production. The most frequent and devastating is wilt of pepper caused either by *Verticillium albo-atrum* or *Fusarium oxysporum*. When climatic conditions are favorable, *Phytophthora capsici* may occur in pepper fields in south of the country. Very often, bacterial diseases of pepper, such as leaf spot caused by *Pseudomonas syringae* pv. *syringae* and *Xanthomonas axonopodis* pv. *vesicatoria*, and soft rot caused by *Pectobacterium carotovorum* ssp. *carotovorum*, limit total yield and quality of the fruits. Among viruses infecting pepper in Serbia, the most important is *Cucumber mosaic virus* (CMV). Besides, significant losses are caused by *Alfa alfa mosaic virus*, *Tobacco mosaic virus*, *Tomato mosaic virus*, *Potato virus Y*, and *Tomato spotted wilt virus*, while Stolbur appears periodically. Most of the varieties grown in Serbia are susceptible to the pathogens listed above. However, a pepper breeding program resulted in several breeding lines tolerant to *V. albo-atrum*, where the most promising is line L-25. By breeding pepper for resistance to *Tobacco mosaic virus* (TMV) strain P₀, we selected genotypes carrying genes of resistance L¹L¹, registered as commercial cultivars Danica and Virdzina. Pepper genotypes carrying L²L² genes for resistance to TMV isolates are selected as well. By crossing breeding lines selected for tolerance to CMV and lines with incorporated genetic sterility (gene *ms3*) we created hybrids of pepper tolerant to this virus. Breeding pepper for resistance to complex infections (CMV, TMV, *Verticillium albo-atrum*) as well as breeding for resistance to *X. a.* pv. *vesicatoria* races P7 and P8 is under way.

Incidence of powdery mildew on pollen viability of *Capsicum*

Nandadevi^{1,2} and P. R. Dharmatti¹

¹ *Department of Horticulture, UAS, Dharwad*

² *Email: nandadevi_s@indiatimes.com*

An experiment was conducted to study the effect of powdery mildew incidence on pollen viability at Olericulture unit, University of Agricultural Sciences, Dharwad, Karnataka, India. Thirteen capsicum genotypes evaluated under field condition were selected. Among which local types (Tarihal local, Goa local and Guntur local) were tolerant to powdery mildew incidence while, all bell shaped peppers were susceptible. These genotypes were subjected to fungal infection and pollen viability test. It was observed that per cent pollen sterility was highest in Arka Gaurav (28.71%) followed by 4080-15 (25.15%). The least per cent pollen sterility was observed in Goa local (15.00%), Tarihal local (17.17%) and PMR-57/88/k (19.85%). Yield and yield parameters of the susceptible varieties were drastically reduced.

QTL mapping of Anthracnose (*Colletotrichum capsici*) in Chilli

P. Pakdeewaraporn¹, S. Wasee², P. Taylor³ and O. Mongkolporn^{4,5}

¹ Center for Agricultural Biotechnology, Kasetsart University, Kamphaengsaen Campus, Nakhon Pathom 73140, Thailand. ² Tropical Vegetable Research Center, Kasetsart University, Kamphaengsaen Campus, Nakhon Pathom 73140, Thailand. ³ bioMarka, Institute of Land and Food Resources, The University of Melbourne, Victoria 3010 Australia.

⁴ Department of Horticulture, Kasetsart University, Kamphaengsaen Campus, Nakhon Pathom 73140, Thailand. ⁵ Email: orarat.m@ku.ac.th

Anthracnose caused by *Colletotrichum capsici* is one of the most damaging diseases of chili in Thailand. An interspecific cross was made between an anthracnose resistant *Capsicum chinense* Jacq. 'PBC932' and a Thai elite cultivar *C. annuum* L. 'Bangchang'. The resistance was evaluated using a laboratory bioassay by injection method. The segregation of the resistance and susceptibility as measured by lesion area and lesion area/fruit area in a F₂ and BC_{1S} populations indicated a recessive gene was responsible for resistance. Large variations of susceptibility levels were observed in this cross. Mapping approach was used to identify QTLs that were responsible for the trait.

Resistance of *capsicum annuum* l. lines to Chilli Veinal Mottle Potyvirus isolate, inheritance and allelism studies for resistance genes

K. Madhavi Reddy, M. Krishna Reddy, C. N. Lakshminarayana Reddy and A. T. Sadashiva

Indian Institute of Horticultural Research, Hessaraghatta Lake Post, Bangalore – 560 089, Karnataka, India

Chilli (*Capsicum annuum* L.) is an important commercial crop of India occupies an area of 0.956 m. ha with an annual production of 0.945 MT. About 21 viruses are known to infect the chilli crop in India, among them CVMV is more serious in major chilli growing areas causing yield loss up to 50 per cent. At IIHR, about 50 lines were evaluated for resistance to CVMV isolate from Bangalore, India through mechanical inoculation under screen house conditions. Visual observations were recorded at weekly intervals for 6 weeks and further confirmed by ELISA. Stable resistance to CVMV has been identified in six *C. annuum* lines viz., Lorai, Pusa Sada Bahar, Punjab Gucchedar, Jawahar 218, Pant C1 and Tiwari. Genetic studies were conducted to determine the inheritance of resistance. Allelism studies of the resistance genes from six resistant sources identified is underway.

Genetics of resistance to Cucumber Mosaic Virus (CMV) in sweet pepper (*Capsicum annuum* L.)

T. Saito^{1,2}, T. Yoshida^{1,3}, A. Saito¹ and T. Yamada¹

¹ National Institute of Vegetable and Tea Science, Kusawa, Ano, Mie 514-2392, Japan.

² Email: romario@affrc.go.jp. ³ Headquarters of National Agriculture and Bio-oriented Research Organization.

Abstract: CMV causes severe damage and economic loss in sweet or hot pepper production in Japan. Attempts to obtain CMV resistance have been conducted for more than 20 years at the National Institute of Vegetable and Tea Science (NIVTS). Several CMV resistant accessions of *C. annuum* L. introduced from Europe were used as the resistant parents in our laboratory. However, no satisfactory resistant progenies were obtained from crosses between the resistant parents and varieties. Monma and Sakata (1997) screened 83 sweet or hot pepper accessions (*C. annuum* L.) and 57 other *Capsicum* spp. Several accessions including 'CH4-4-3', a hot pepper, were selected as resistant sources. In 1992, 'CH4-4-3' and 'Shin-Sakigake 2', a bell sweet pepper cultivar, were crossed. F₈ line was selected for CMV resistance and no pungency, and named 'CMVR00-01' in 2000. The inheritance of CMV resistance in the breeding line 'CMVR00-01' has been studied.

The F₁, F₂ and backcross generations from the crosses between 'CMVR00-01' and 'Mie-Midori' were obtained. 'Mie-Midori' is a bell sweet pepper cultivar and susceptible to CMV. All the obtained progeny was inoculated by a mechanical inoculation at the cotyledonary stage. The inoculum was prepared from frozen young leaves with mosaic symptoms of 'Xanthi-NC' (*Nicotiana tabacum* L.). The inoculation was performed by rubbing the inoculum on cotyledons previously dusted with 600-mesh carborundum using a tampon. Plants were evaluated using a symptom index of 0; no symptom, 1; slight mosaic, 2; light mosaic, 3; moderate mosaic, and 4; heavy mosaic at 2 weeks after inoculation. They were grouped in 3 categories for Chi-square analysis, based on disease ratings: resistant (index 0 and 1), intermediate (index 2) and susceptible (index 3 and 4).

All the F₁ plants were intermediate and the observed segregations fitted well with 3 resistant: 6 intermediate: 7 susceptible in the F₂, 0: 1: 3 in the BC-S, and 1: 1: 0 in the BC-R. Segregation ratios suggested a digenic control of 2 incompletely dominant genes.

Identification of stable sources of resistance to bacterial wilt (*Ralstonia solanacearum*) in eggplant (*Solanum melongena* L.)

T.H. Singh¹, A.T. Sadashiva¹, K. Madhavi Reddy¹, M.V. Balaram¹, L.R. Naveen¹ and K. Krishna Murthy¹

¹*Indian Institute of Horticultural Research, Hessaraghatta Lake Post, Bangalore-560 089, Karnataka, INDIA*

Eggplant (*Solanum melongena* L.) is one of the important vegetable crops cultivated in tropical and sub-tropical regions of the world. It is cultivated in an area of 7.28-lakh ha. in the world and 72% of total world acreage (5.24-lakh ha) is in India. Bacterial wilt caused by *Ralstonia solanacearum* is one of the most devastating diseases of eggplant in both tropical and sub-tropical regions of the world causing yield loss up-to 60-100 per cent. Evolving bacterial wilt resistant varieties/ F₁ hybrids will go a long way to solve this malady. Systematic breeding programme for the past several years resulted in identification of stable sources of resistance to bacterial wilt (race 1, biovar 3 of the pathogen) in different genetic background in ten eggplant lines. Systematic breeding work was carried out at IIHR in the bacterial wilt infested soil resulted in identification of ten stable sources of resistance to bacterial wilt. The bacterial population / inoculum of 10⁶ cfu /g. of soil was maintained in the soil. The seedlings were dipped in a bacterial suspension of 0.7 O.D and transplanted in the main field. The plants were further inoculated with inoculum artificially after twenty days of transplanting by pin prick method. The most promising bacterial wilt resistant lines were IIHR-500A, IIHR-180, IIHR-181, IIHR-3, IIHR-7, IIHR-322, IIHR-236, IIHR-128, IIHR-129 and IIHR-130. Three F₁ hybrids developed using these resistant sources viz; BPLH-1, BWBH-3 and BWBH-4 and found promising for high yield with resistance to bacterial wilt.

Two linked QTLs determine most of the variation for anthracnose (*Colletotrichum gloeosporioides*) resistance in a *Capsicum annuum* x *C. chinense* cross

Roeland E. Voorrips, Richard Finkers, Lia Sanjaya, Remmelt Groenwold

Plant Research International, P.O. Box 16, 6700 AA Wageningen, The Netherlands. Contact: roeland.voorrips@wur.nl, Tel +31.317.477289

Anthracnose fruit rot is an important disease in pepper production in Indonesia. Strong resistance to two causal pathogens: *Colletotrichum gloeosporioides* and *C. capsici* was found in an accession of *Capsicum chinense*. The inheritance of this resistance was studied in an F₂ population derived from a cross of this accession with a susceptible Indonesian hot pepper variety (*C. annuum*), using a Quantitative Trait Locus (QTL) mapping approach. In laboratory tests where ripe fruits were artificially inoculated with *C. gloeosporioides*, three resistance-related traits were scored: the Infection frequency, the True lesion diameter (averaged over all lesions that actually developed), and the Overall lesion diameter (averaged over all inoculation points, including those that did not develop lesions). For the susceptible and resistant parent respectively, the infection frequencies were 31 and 100%, the true lesion diameters 22 and 7 mm, and the overall lesion diameters 23 and 3 mm.

Four QTLs were identified affecting True and Overall lesion diameter. Three of these also affected Infection frequency. The two QTLs with the largest effects were located on the same linkage group, with an estimated interval of 7 cM. These two QTLs were responsible for 77 and 52% of the parental difference for Infection frequency, 42 and 30% of the difference for True lesion diameter and 57 and 39% of the difference for Overall lesion diameter respectively. For one of these two QTLs the resistant allele was inherited from the susceptible parent, which explains how the sum of the QTL effects can be larger than 100% of the parental difference. By recombination of the resistant alleles of both QTLs it should be possible to obtain a level of anthracnose resistance that surpasses even that of the resistant parent in this cross.

BIOTECHNOLOGY

Management of resistance to Coleoptera (*Leptinotarsa decemlineata* – Say) in transgenic eggplant (*Solanum melongena* L.) hybrids

Mennella G.¹, D'Alessandro A.¹, Arpaia S.², Acciarri N.³, Sunseri F.^{4§}, Rotino G.L.⁵

¹ Istituto Sperimentale Orticoltura, P.O. BOX 48 I-84098 Pontecagnano (SA), Italy

² ENEA - Research Center Trisaia S.S. 106 Ionica, km 419+500 I-75026 Rotondella (MT), Italy

³ Istituto Sperimentale Orticoltura, I-63030 Monsampolo del Tronto (AP), Italy

⁴ Dipartimento Biologia, Difesa e Biotecnologie AgroForestali - Via Ateneo Lucano 10, Università della Basilicata, I-85100 Potenza, Italy

⁵ Istituto Sperimentale Orticoltura, Via Paulllese 28 I-26836 Montanaso L. (LO), Italy

[§] contact: sunseri@unibas.it, Tel +39.971.205549, Fax +39.971.673111

Abstract: In European and American countries the Colorado potato beetle (*Leptinotarsa decemlineata* – Say) causes heavy damage in potato and eggplant cultivations especially where it has developed resistance against many insecticides. Since transgenic plants expressing Bt-derived toxins are effective in controlling insect pests, the availability of insect-resistant transgenic eggplant hybrids provides new possibilities for the management of resistance to the Colorado potato beetle (CPB).

Transgenic eggplant lines bearing a mutagenized *Bacillus thuringiensis* Berl. Cry3B gene, were previously obtained and tested to assess their insect resistance capabilities. The two best transgenic lines, were selfed in order to obtain homozygous lines for CPB gene resistance, then were utilized as parents for transgenic F₁ hybrids. Field trials were set up at two different locations for 2 years (1998, 1999) evaluating the performances of two transgenic hybrids and their untransformed control. In the same experimental design, plots composed by 100% transgenic plants were compared to mix plot with 80% of transgenic plants and 20% untransformed refuge plants. Data were recorded bi-weekly to assess the level of CPB infestation by monitoring the abundance of adults, egg masses and larvae. At harvest, total yield per plot was recorded. Field observations confirmed that Bt-expressing eggplant hybrids were able to control CPB infestation in eggplant. Significantly higher production was obtained from both transgenic hybrids compared to the control in the year with heavier CPB attack. No statistical differences were evidenced (both in yield and insect abundance) between the two methods of transgenic plants deployment, thus the adoption of a mix plot with refuge plants may represent a potential effective and durable means of CPB control in eggplant cultivation.

Keywords: *Solanum melongena*, genetic transformation, *Bacillus thuringiensis*, insect resistance, mix plot deployment, refuge plant.

Introduction

The heavy damage caused by Colorado potato beetle (CPB) in eggplant and potato is critical for their production in Europe and America (Arpaia *et al.*, 1995; Hamilton *et al.*, 1997). Transgenic resistance to insect has proved to be effective in several crop species and Bt-expressing varieties among the most largely (18%) cultivated engineered crop in the world (James, 2003). The use of transgenic resistant cultivars of horticultural crops may be an alternative mean of CPB control. Potato “Newleaf” cultivar, resistant to CPB by expressing Bt cry3A gene, is authorized to cultivation, processing and human consumption in USA (Reed *et al.*, 2001). Transgenic eggplants (*Solanum melongena* L.) for modified Cry3 genes proved to be resistant to CPB (Arpaia *et al.*, 1997; Hamilton *et al.*, 1997; Jelenkovic *et al.*, 1998) and may represent a new and effective means of pest control.

Resistant eggplant parental lines expressing a Cry3B gene (Iannacone *et al.*, 1997) were obtained (Arpaia *et al.*, 1997) and field evaluated for insect resistance under natural CPB infestation (Acciarri *et al.*, 2000).

The aim of this study was to evaluate transgenic eggplant hybrids, obtained by crossing the two high expressing parental lines above mentioned, for the stability of their resistance to CPB under natural infestation using two deployment methods and their yield performances.

Material and methods

Plant material

Two transgenic eggplant hybrids, named A and B, were obtained by crossing the high expressing homozygous Bt-gene lines #3-2 and #9-8 of DR2 parent (Acciarri *et al.*, 2000) with the untransformed eggplant parental line TAL #1-1. *In vivo* screening (Sunseri *et al.*, 1993) for kanamycin resistance confirmed, as expected, that all the F₁ plants harboured the transgene.

Experimental fields

Field trials were set for 2 years at two different Italian locations: Monsampolo-AP (1998) and Pontecagnano-SA (1999) with the approval of the Italian Ministry of Health (No. B/IT/98/21 and B/IT/99/18). The experimental fields were prepared in a completely randomized design with four replications. Transgenic plants were deployed according to two modalities: plots containing 100% transgenic plants and plots with 80% of transgenic plants and 20% of untransformed refuge plants (mix plot). In the mix plot the non-toxic refuge plants were randomly distributed. No pesticide sprays were done through the whole growing seasons and only natural CPB infestation was evaluated. Eggplants were mulched, planted in double rows with a density of 2.2 plants/m² and cultivated following the traditional cultural practices of each location (e.g., La Malfa, 1990). Each plot measured 4.5 x 9.6 m and contained 96 plants.

Field observations

Data were collected twice a week beginning 3 weeks after transplanting. Ten plants randomly chosen in each plot were observed to determine the number of the different stages of CPB [i.e. adults, egg masses, small (I-II stadium) and large (III-IV stadium) larvae]. Surveys were carried out for at least 10 weeks both in Monsampolo and Pontecagnano fields. At each harvest, fruit number and weight were also recorded.

Statistical analyses

Insect presences and fruit yields were analyzed as a completely randomized design with repeated measures. Means were compared by Q Ryan Test. All the analyses were performed by using SAS software, version 8.02 for Windows (SAS, 1989).

Results and discussion

All the F₁ plants were resistant to kanamycin according to the *in vivo* screening, as expected when in a F₁ hybrid a parent carries a dominant gene at homozygous level, therefore all the plants used in fields trials bore the transgene at the heterozygous state.

In 1998 at Monsampolo, the *L. decemlineata* population was rather high, while in 1999 the level of insect infestation was lower. On the contrary, at Pontecagnano in 1999 the CPB population was sizeable, whilst in 1998 it was almost negligible (Figure 1).

The number of larvae per plant was clearly and significantly (Tables 1 and 2) reduced in all the transgenic plots with respect to the untransformed control regardless of the extent of CPB infestation. When the insect populations were large (Monsampolo 1998 and Pontecagnano 1999) crop yield was significantly higher in the transgenic plots compared to the untransformed controls (Tables 1 and 2, Figure 2). It is interesting to underline the absence of significant differences between the two methods of transgenic plant release. In both cases, a significantly higher number of larvae and adults was found in the control hybrid with respect to the transgenic ones; moreover no significant differences on beetle populations were evidenced between the 100% transgenic plots and the mixed ones (Tables 1 and 2, Figure 1). Only the number of adults rose to an intermediate level in Pontecagnano in the mix plots. The feeding activity of the larvae drastically reduced the yield potential in the untransformed hybrid, when the infestation was significant. When insect populations were negligible (Pontecagnano 1998 and Monsampolo 1999), no statistical difference in crop yield was observed between transgenic hybrids and their control (data not shown). On that account, it is worthwhile to note that no negative effects due to the constitutive expression of the Bt and NPTII genes were evidenced on the yield potentiality when the CPB infestation did not cause appreciable economical damage in the susceptible eggplant hybrid [Figure 1A shows that the level of larvae/plant is below to the economic threshold (5 large larvae/plant as reported by Arpaia *et al.*, 1995)].

These data confirmed that the Bt cry3B gene at the heterozygous state allowed a permanent protection over two consecutive years. Moreover, a mixture composed by 80% transgenic Bt eggplants and 20% of non-toxic refuge plants was equally effective in controlling the CPB infestation as 100% of transgenic plants. The presence of refuge plants coupled with high Bt-expressing genotypes is considered a valid strategy to increase the durability of the Bt resistance gene by delaying the onset of insect resistance to the toxin (Gould, 1998). A specific model for predicting CPB adaptation to Cry3 toxin expressed in transgenic eggplant indicated that already a 10% mix plot would delay the possible adaptation to transgenic plants for many generations (Arpaia *et al.*, 1998).

Our study demonstrates that without any pesticide treatment, plots with 20% of refuge plants gave a sufficient protection against CPB since the presence of feeding larvae was similar to the pure stands of transgenics. Therefore, negligible economic loss maybe expected using this refuge strategy. However, additional field trials are necessary to evaluate the effects of Bt-expressing eggplant on non-target entomofauna. The method of plant release may be further optimized in accordance with the ecological, biological and genetic features of *L. decemlineata* as well as with the common agronomic practices.

Table 1. Eggmasses, larvae, adults of *Leptinotarsa decemlineata* Say and eggplant fruit production for field data collected at Monsampolo (Italy) in 1998.

<i>Hybrid</i>	<i>No. Egg masses/ plant</i>	<i>No. Small larvae/plant</i>	<i>No. Large larvae/plant</i>	<i>No. Adults/plant</i>	<i>Yield Kg/plant</i>
A 100%	0.917 a	1.453 b	0.011 b	1.063 b	2.108 a
B 100%	0.737 a	1.576 b	0.243 b	0.948 b	2.254 a
A mix	0.812 a	2.627 b	0.601 b	1.048 b	2.149 a
B mix	0.808 a	1.905 b	0.443 b	0.950 b	1.906 a
C	1.071 a	10.315 a	5.919 a	2.228 a	1.288 b

* Mean separation within columns and parameters by Q Ryan test, P = 0.05

Table 2. Eggmasses, larvae, adults of *Leptinotarsa decemlineata* Say and eggplant fruit production for field data collected at Pontecagnano (Italy) in 1999.

<i>Hybrid</i>	<i>No. Egg masses/ plant</i>	<i>No. Small larvae/plant</i>	<i>No. Large larvae/plant</i>	<i>No. Adults/plant</i>	<i>Yield Kg/plant</i>
A 100%	0.132 ab*	0.414 b	0.210 b	2.143 b	2.480 a
B 100%	0.089 b	0.062 b	0.034 b	2.206 b	2.768 a
A mix	0.193 ab	1.153 b	2.189 b	2.808 ab	2.435 a
B mix	0.149 ab	0.786 b	1.606 b	2.677 ab	2.401 a
C	0.254 a	3.147 a	11.942 a	3.739 a	1.473 b

* Mean separation within columns and parameters by Q Ryan test, P = 0.05

Figure 1: Field observations of CPB larvae presence at Pontecagnano (A) and Monsampolo (B) in 1998. As reported in the results, the differences on insect populations between the 2 locations appear evident. On the contrary, during 1999, the insect population was more sizeable at Pontecagnano (data not shown).

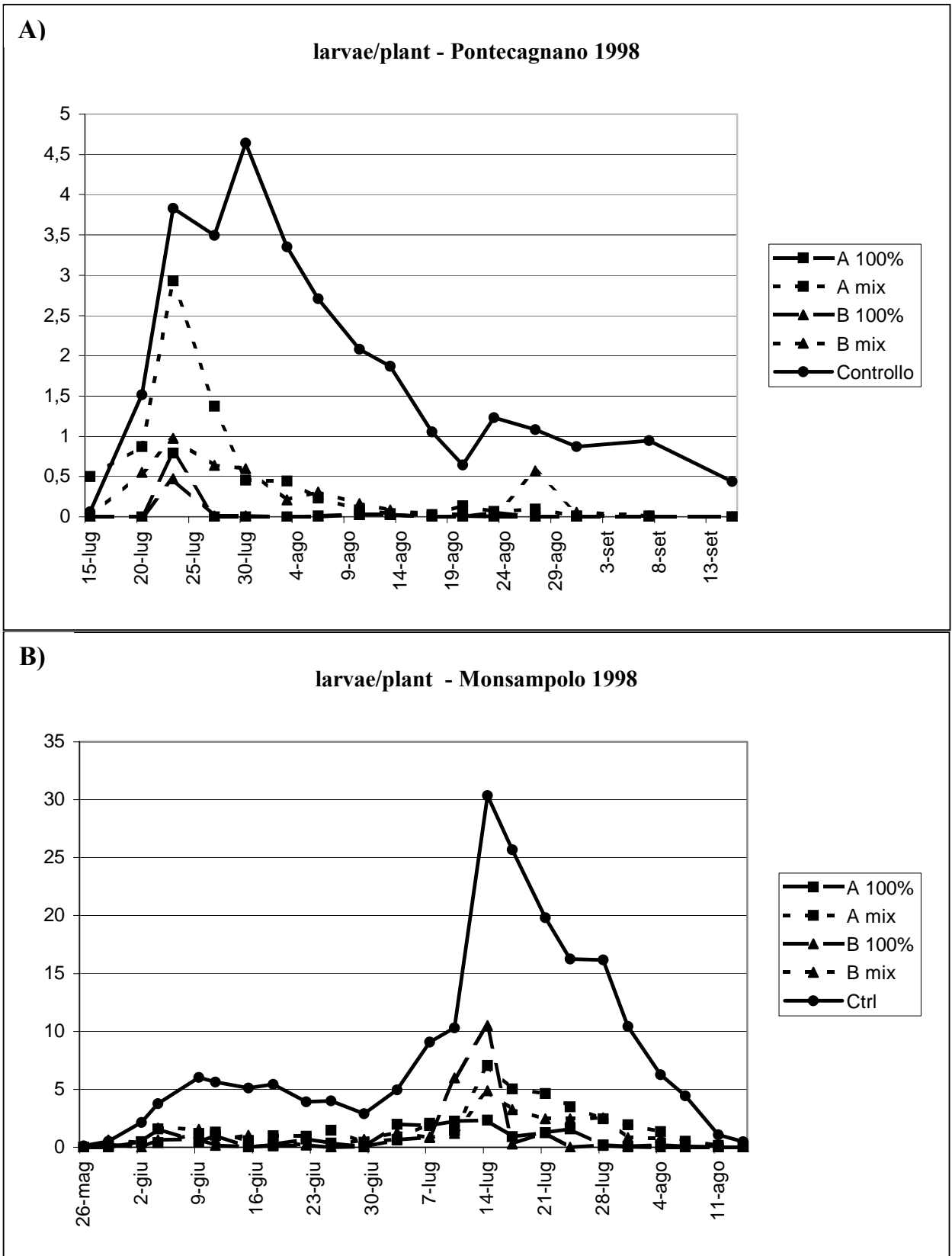
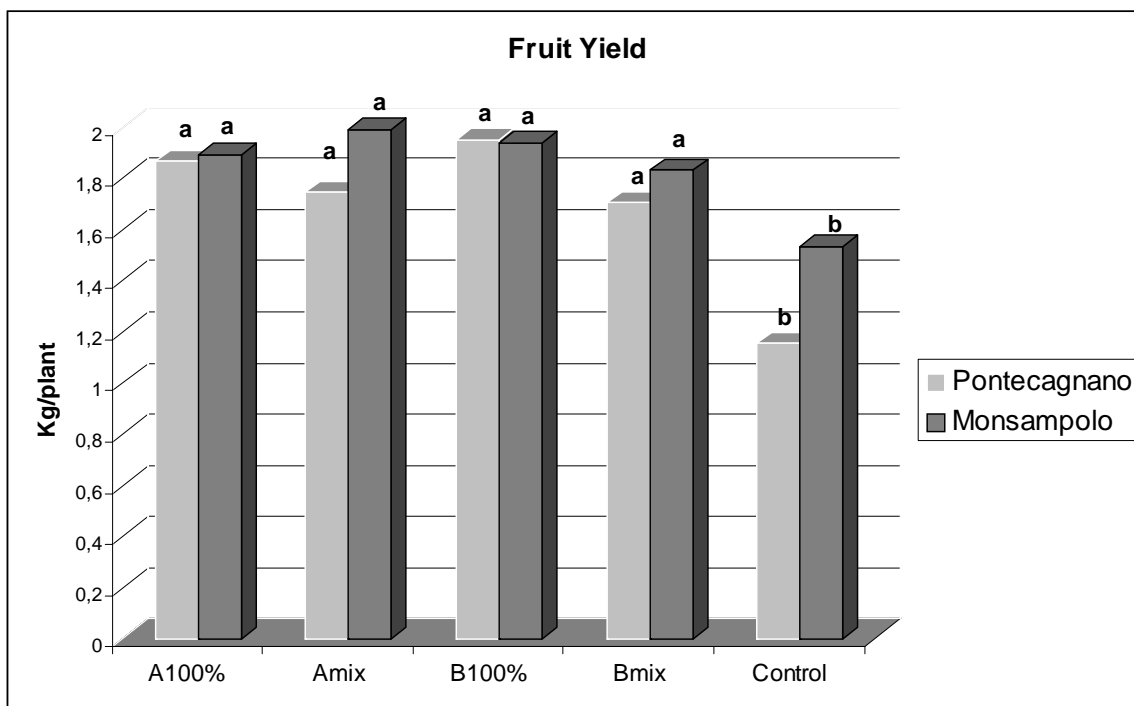

Figure 2: Average eggplant fruit yield at the 2 locations during 1998 and 1999. Each column in the figure represent the mean of the 2 years. The different letters indicate significantly differences among the data of each location (Q Ryan Test $P = 0,05$).



Acknowledgements

This work was partially supported by the Italian Ministry of Agricultural Policy in the framework of the “Piano Nazionale Orticoltura”.

References

- Acciarri, N. Arpaia, S. Mennella, G. Vitelli, G. Sunseri, F. & Rotino, G.L. 2000: Transgenic resistance to the Colorado Potato Beetle in Bt-expressing eggplant field. *HortScience* 35: 722-725.
- Arpaia, S. Lashomb, J.H. & Vail K. 1995: Valutazione dell'attività trofica di *Leptinotarsa decemlineata* (Say) su melanzana. *Informatore Fitopatologico* 2:55-57.
- Arpaia, S. Mennella, G. Onofaro, V. Perri, E. Sunseri, F. & Rotino G.L. 1997: Production of transgenic eggplant (*Solanum melongena* L.) resistant to Colorado potato beetle (*Leptinotarsa decemlineata* Say). *Theoretical Applied Genetics* 95: 329-334.
- Arpaia, S., Chiriatti, K. and Giorio G. 1998 - Predicting the adaptation of Colorado Potato Beetle to transgenic eggplant expressing CryIII toxin: the role of gene dominance, migration and fitness costs. *Journal of Economic Entomology*, 91(1): 21-29.
- Gould, F. Sustainability of transgenic insecticidal cultivars: integrating pest genetics and ecology. *Annu. Rev. Entomol.* 1998, 43, 701-26

- Hamilton, G.C. Jelenkovic, G.L. Lashomb, J.H. Ghidui, G. Billings, S. & Patt, J.M. 1997: Effectiveness of transgenic eggplant (*Solanum melongena* L.) against the Colorado potato beetle. *Advanced Horticultural Science* 11: 189-192.
- Iannacone, R. Grieco, P.D. & Cellini, F. 1997: Specific sequence modifications of a cry3B endotoxin gene result in high levels of expression and insect resistance. *Plant Molecular Biology* 34: 485-496.
- James, C. 2003: Preview: Global Status of Commercialized Transgenic Crops: 2003. ISAAA Briefs No. 30. ISAAA: Ithaca, NY.
- Jelenkovic, G. Billings, S. Chen, Q. Lashomb, J. Hamilton, G. & Ghidui, G. 1998: Transformation of eggplant with synthetic cryIIIA gene produces a high level of resistance to the Colorado potato beetle. *J. American Society Horticultural Science* 123: 19-25.
- La Malfa, G. 1990: Melanzana (*Solanum melongena* L.). In V. Bianco, F. Pimpini (Eds): *Orticultura*. Patron Editore pp: 793-810.
- Reed, G.L. Jensen, A.S. Riebe, J. Head, G. & Duan J.J. 2001: Transgenic Bt potato and conventional insecticides for Colorado potato beetle management: comparative efficacy and non-target impacts. *Entomologia Experimentalis et Applicata* 100: 89-100.
- SAS 1989 - SAS/STAT User's guide. Version 6, Fourth edition, Vol. 2. SAS Institute Inc., Cary, NC.
- Sunseri, F. Fiore, M.C. Mastrovito, F. Tramontano, E. & Rotino G.L. 1993: *In vivo* selection and genetic analysis for kanamycin resistance in transgenic eggplant (*Solanum melongena* L.). *Journal of Genetics & Breeding* 47: 299-306.

Production and utilization of sexual “double hybrid” between the somatic hybrids *S. melongena* (+) *S. integrifolium* and *S. melongena* (+) *S. aethiopicum* gr. *Gilo*

Rotino G.L.^{1,2}, Rizza F.³, Mennella G.⁴, Tacconi M.G.¹, Alberti P.¹, D’Alessandro A.⁴, Acciarri N.⁵, Toppino L.¹

¹Istituto Sperimentale per l’Orticoltura- Sezione di Montanaso Lombardo (LO), Italy. ²Email: pinuzzu.rotino@virgilio.it. ³Istituto Sperimentale per la Cerealicoltura- Sezione di Fiorenzuola d’Arda (PC), Italy. ⁴Istituto Sperimentale per l’Orticoltura, P.O. BOX 48 I-84098 Pontecagnano (SA), Italy. ⁵Istituto Sperimentale per l’Orticoltura, I-63030 Monsampolo del Tronto (AP), Italy.

Abstract: *Solanum aethiopicum* gr. *gilo* and *Solanum integrifolium* (= *Solanum aethiopicum* gr. *aculeatum*) are two close wild relative species of *S. melongena* which show resistance to *Fusarium oxysporum* f. sp. *melongenae* and *Ralstonia solanacearum*, two soil borne and very destructive diseases of eggplant. In order to enable the introgression of these resistance traits into eggplant gene pool, tetraploid somatic hybrids [*S. integrifolium* (+) *S. melongena* line 1F5(9) and *S. aethiopicum*(+) *S. melongena* cv Dourga] were obtained by electrofusion of protoplasts. With the purpose to incorporate useful characters of both wild species into eggplant breeding lines the two somatic hybrids were crossed, using each of them as male and female parent. Dihaploids were successfully generated from anther culture of tetraploid “double hybrids” which showed fully resistance to *Fusarium*. Regenerated androgenic plants have been subjected to biological, phenotypical, molecular and biochemical characterization, and also to artificial inoculation with two different isolates of *Fusarium oxysporum* f. sp. *melongenae*. The molecular ISSR analysis showed that in the dihaploid population a notable segregation of species-specific amplified fragments occurred. Also, a remarkable phenotypic variation was recorded for flower, leaf and fruit features, even if the layout of the values remains between the extremes settled by the parental genotypes, confirming the androgenic nature of the DH population. Artificial inoculation results showed that the segregation of the resistance character in the population occurred with the ratio of 3:1 (resistant:susceptible).

Keywords: *Solanum melongena*, somatic hybridisation, double hybrids, *Fusarium oxysporum* f. sp. *melongenae*, *Solanum aethiopicum*, *Solanum integrifolium*

Introduction

One of the main factor which limits the yield of cultivated eggplant is its susceptibility to soil borne diseases like *Fusarium oxysporum*, *Verticillium dahliae* and *Ralstonia solanacearum*. Wild relatives are a valuable source of genes that can be exploited to enhance the variability of the cultivated crops by the genetic introgression of useful agronomic traits, especially resistance/tolerance to pathogens (Sihachakr et al., 1994).

Solanum aethiopicum gr. *gilo* and *S. integrifolium* (= *Solanum aethiopicum* gr. *aculeatum*), two allied species close to *Solanum melongena*, have been characterized as both resistant to *Fusarium oxysporum* f. sp. *melongenae* and to some strains of bacterial wilt (*Ralstonia solanacearum*). In order to overcome the sexual barriers existing between eggplant and these allied species, protoplast fusion was utilized to obtain tetraploid somatic hybrids (Sihachakr et al., 1994). With regard to other phenotypic features, the two species employed in the somatic hybridization are extremely divergent: in fact, besides the presence of spine and anthocyanin in stem, apex, leaf veins and petals, and their differences in shape and colour of the fruits *S. integrifolium* shows a certain degree of tolerance to spider mites, whereas *S.*

aethiopicum is particularly susceptible to them, moreover its fruits are used as food in some countries and show a delayed browning of the flesh.

With the purpose to incorporate useful traits of both the wild species into the eggplant gene pool, crosses were successfully performed between the two somatic hybrids, each of them used both as male and as female parent. The resulting tetraploid “double hybrid” progenies were characterized for resistance to *Fusarium* and fully resistant plants were used as anther donors. In the present study we report the phenotypic, molecular and biological characterization of the “double hybrids” and of their androgenic progeny derived from anther culture.

Material and methods

Plant material

All the plants were grown in the greenhouse or under *in vitro* condition. The plant material employed were: the fusion parents, the somatic hybrids D•Sa (obtained by protoplast electrofusion between *S. melongena* cv Dourga and *S. aethiopicum* gr *gilo*) (Collonier et al., 2001) and A# 1-1 (between *S. melongena* line 1F5(9) and *S. integrifolium*) (Rotino et al., 1998), 13 plants from the “double hybrids” obtained by crossing the somatic hybrids and 125 androgenic plants from “double hybrids” anther culture.

Anther culture

Anther culture has been carried out according to Rotino (1996), using 4 different induction medium: C3 (3 KIN + 1 IAA), C6 (5 KIN + 5 NAA), C9 (1 ZEA + 3 NAA) and C12 (0.5 TDZ + 0.1 ZEA + 0.5 IAA). Androgenic calli were transferred to the regeneration medium (MS + 0.5 ZEA, 0.3 KIN and 0.1 BAP), while embryos and regenerated plants were, respectively, germinated or rooted in V3 medium.

Ploidy determination

Ploidy determination was indirectly detected by chloroplast counting in the stomata guard cells: small pieces of leaves have been covered by one drop of Fluoresceine Diacetate (FDA, 50 $\mu\text{l ml}^{-1}$ in acetone diluted 1:100 with distilled water) and observed with a microscope under UV-filtered light.

Morphological characterization and pollen vitality

For each genotype analyzed, the following traits have been registered: presence of spine and anthocyanins in stem, leaves and veins; number of flowers per inflorescence; number and length of anthers, petal and stigma colour, length and diameter of the principal flower. Colour, weight, peduncle length, polar and equatorial diameter of the fruits produced were recorded. Pollen viability was evaluated using a phase-contrast microscope after staining with acetocarmine.

Isozyme analyses

The procedure to perform characterization of shikimate dehydrogenase (SKDH, E.C. 1.1.1.25) and glucose-6-phosphate dehydrogenase (G-6-PDH, E.C. 1.1.1.49) was as reported in Rizza et al. (2002).

Molecular characterization

DNA was extracted from young leaves using the “Nucleon Phytopure Plant DNA Extraction Kit” (Amersham Life Science). Molecular ISSR analysis was carried out using UBC Primer

Set # 9 (University of British Columbia). The reaction was performed in 20 μ l final volume containing 1X buffer (Gibco), 2mM MgCl₂, 0.1mM dNTPs, 0.8U Platinum Taq Polimerase (Gibco) and 1ng μ l⁻¹ of DNA. Amplification reaction was run according to the following profile: 1 cycle of 3 min at 94°C; 45 cycles of 30 sec at 94°C, 45 sec at 55°C, 2 min at 72°C; one cycle of 5 min at 72°C. PCR products were separated by electrophoresis in a 1.2% agarose gel containing 1.5ng μ l⁻¹ ethidium bromide at 55 V/cm for 4 hours in TAE 1X buffer.

Fusarium inoculation

Artificial inoculation with an Italian and a Dutch isolate of *Fusarium oxysporum* was carried out as in Cappelli et al. (1995). Three weeks old *ex vitro* or seed-derived plantlets have been infected and kept in a growth chamber (25 \pm 2°C: 50 μ Em⁻²s⁻¹); disease outcomes have been evaluated after 4-6 weeks as percent of survival.

Results and discussion

Anther culture

From the crosses attempted among the somatic hybrids, six combinations of “double hybrids” were obtained and characterized. Thirteen fully resistant plants to *Fusarium* from the offsprings of these “double hybrids” were grown into the greenhouse and used as anther donors.

A total of 3421 anthers were cultured on the 4 different induction media and gave rise to calli and androgenic embryos. Among the media tested C6 gave the highest yield of embryos (7%) but induced few calli (1%), while C9 and C12 were more efficient in inducing calli (5% and 4% respectively) than embryos (1.6% and 0.7%). C3 medium was the less effective in inducing both androgenic embryos (0,3%) and calli (0%).

Ploidy determination

The number of chloroplasts per stomata guard cells of the somatic hybrids and of the “double hybrid” plants was about doubled if compared to the parental genotypes (21.1 vs 11). Most of the androgenic plants from the “double hybrid” anther culture, regardless of their origin, (embryogenesis or organogenesis) were scored as diploids according to their number of chloroplast (average of 10.5). Only 3 plants out of 61 showed a number of chloroplasts similar to that of the somatic hybrids and were classified as tetraploids. These results confirm the androgenic origin of both embryo- and callus-derived plants.

Morphological characterization and pollen viability

Detailed morphological characterization was performed on the fusion parents, the two somatic hybrids D•Sa 2-1 and A#1-1, the “double hybrid” plant IA3 and 32 androgenic plants derived from anther culture of different resistant “double hybrids”. The plants of the three hybrids (somatic and sexual) showed high vigour and large leaves, their average pollen viability was about 65% and they set orange fruits which produced viable seeds and showed green stripes in their upper parts when immature. In general, the measured values of the “double hybrid” and the somatic hybrids were intermediate with respect to that of the fusion parents (Table 1). A higher level of variability was observed among the 32 dihaploid analyzed; growth habit as well as flower and fruit characteristics displayed a wider variation with respect to the donor hybrids. However, the values remained within the range determined by the fusion parents except for the number of anthers, with many dihaploids having lower values than the wild species *S. aethiopicum* and *S. integrifolium*. The average viability of their pollen was low (16.41%) and ranged from 8.00% to 63.82%, the higher values were displayed by the

tetraploid genotypes. It is worth to point out that the pollen viability was enhanced when compared with the DH populations obtained from the single somatic hybrids (Rizza et al., 2002; Rotino et al., 2001). Despite this increase, however, only about 50% of the plants grown in the greenhouse produced from 1 to 36 parthenocarpic fruits, whose weight, size and orange colour was still more similar to the wild fusion parents (only one androgenetic plants gave fruits with seeds, which resembled to the cultivated eggplant cv Dourga). Phenotypic variation among the dihaploids was evidenced for the other traits, like the presence of dark-green stripes on the immature fruit as also of spines in the calix. It is remarkable that segregation of all the considered traits was evidenced in the androgenic population.

Molecular analysis

Molecular ISSR analysis has been performed using 27 UBC primers chosen as resulting the most polymorphic between the fusion parents (in fact, each primer amplified at least one discriminating fragment). Twenty-seven androgenic plants, the somatic hybrids and the fusion parents have been analysed. From this molecular analysis, the following considerations can be made:

- a) Out of 382 bands detected in the amplifications of the four fusion parents (*S. melongena* cv Dourga and line 1F5(9), *S. integrifolium* and *S. aethiopicum*) 297 were, at least, polymorphic between two of them;
- b) *S. integrifolium* and *S. aethiopicum* were confirmed to be similar each other showing a total of 47 discriminating ISSR loci; a comparable number of polymorphic bands (44) was found between the two *Solanum melongena* parental genotypes;
- c) The two somatic hybrids showed very similar amplification patterns with presence of almost all the loci owned by their fusion parents, this confirmed their hybrid nature. However, the amplification of unexpected fragments has happened; for example, presence of new bands in the amplification pattern of the hybrids which were absent in all the four fusion parents or vice versa. These phenomena may be due to actual genomic reassortment during tetraploid hybrid state which causes variations (Comai, 2000).
- d) In the amplification patterns of the dihaploid population, the presence of the fragment belonging to each fusion parent is higher (67.8%) than its absence, but the segregation ratio is consistently higher if compared with the DH population obtained from single somatic hybrids. Few unexpected amplification patterns have been detected in the androgenic genomes if compared with the fusion parents; the same explanation given above may be valid to justify this phenomenon.

Isozyme analyses

SKDH zymograms showed two anodal activity bands in the cultivated parents, two cathodal ones in the wild parents, four bands in the hybrids and the same bands evidenced in the hybrids or a certain degree of segregation in the dihaploids.

6-PGDH zymograms of the cultivated parents exhibited two fast migrating bands whereas the wild parents showed one anodal and two cathodal bands; four activity zone were evident in the zymogram of the hybrids and segregant (two or three bands) or non-segregant (four bands) plants were scored among the dihaploids. These data showed that isozymes are a useful method for hybrids characterization and checking the androgenic origin of the anther-derived plants.

Fusarium inoculation

The experiment has been carried out to verify the resistance of fusion parents, somatic and “double” hybrids, and of 125 dihaploid genotypes (a total of 1521 *ex vitro* cuttings) against two different isolates (a Dutch and an Italian one) of *Fusarium oxysporum*. After 4 weeks from inoculation the two *Fusarium* isolates seemed to be differently virulent being most of the plantlets inoculated with the Dutch strain yellowish but not dead. However, after 6 weeks all the plantlets gave the same response regardless of the fungus isolate employed. The *Fusarium* resistance trait has been maintained in the somatic and “double” hybrids while showed clear segregation in the dihaploids. Resistance, therefore, is due to a dominant character which also segregated independently from other morphological traits. In this case resistant/susceptible ratio is largely lower (3:1) than that of the DH population obtained from single somatic hybrids (8:1) (unpublished data). The resistance character seems to behave like a monomendelian dominant factor, leading to the conclusion that segregation of the traits is increased in the progeny coming from “double hybrids”.

Likely the contemporary presence of two genomes of eggplant and two genomes of wild species, (already undergone to “partial recombination” with eggplant in the somatic hybrids) promotes, during meiosis, a better match between homeologous chromosomes in the “double hybrid”, leading to an increased recombination. This hypothesis is supported by the results obtained from both the molecular analysis and the bio-morphological characterisation, and by the enhanced pollen viability of the androgenetic population if compared with the DH population from single somatic hybrids.

In conclusion, the strategy of the “double hybrid” may facilitate the introgression of useful characters into the cultivated eggplant from wild relatives.

Table 1. Mean and range (minimum and maximum) of the phenotypic characteristics of flowers and fruits, and pollen viability of the fusion parents [*S. melongena* cv Dourga and line 1F(5)9, the relative species *S. aethiopicum* and *S. integrifolium*], the two somatic hybrids eggplant cv Dourga(+)*S. aethiopicum* (D•Sa 2/1) and eggplant line 1F5(9)(+) *S. integrifolium* (A#1-1), the sexual double hybrid between the two somatic hybrids and the dihaploids obtained through anther culture of the double hybrid.

Traits	<i>S. melongena</i>		<i>S. aeth</i>	<i>S. int</i>	Somatic hybrids		Double hybrid	Dihaploids	
	Dourga	1F(5)9			D • Sa 2/1	A # 1-1		mean	range
N° of flowers	1,20	2,30	2,00	8,00	6,60	9,64	7,00	4,91	1,00-8,80
N° of anthers	6,00	6,40	5,60	5,40	5,10	6,31	5,50	5,38	4,70-6,20
Flower diam (mm)	8,15	9,15	4,35	5,60	6,90	7,15	6,95	5,55	4,10-7,70
Flower lenght (mm)	15,10	17,50	10,25	7,89	18,00	15,86	14,50	12,52	10,10-18,50
Anther lenght (mm)	8,45	8,85	6,00	8,00	10,10	9,06	8,25	7,26	5,05-8,38
Pollen viability (%)	74,31	82,01	76,28	85,14	69,60	60,77	68,51	16,41	7,64-63,82
Fruit weight (g)	225,00	318,00	7,90	18,00	17,10	23,70	52,90	16,66	6,70-32,2
Fruit lenght (cm)	19,70	11,30	2,90	2,10	5,10	3,20	6,00	3,58	2,53-7,20
Fruit width (cm)	5,50	8,50	1,80	3,20	2,50	3,70	4,97	2,96	2,20-3,83
Diam fruit ratio	0,28	0,75	0,62	1,52	0,49	1,16	0,83	0,83	0,67-1,09

Table 2. Results of inoculation with Dutch and Italian *Fusarium oxysporum* of *ex vitro* dihaploid cuttings derived from the “double hybrids” and the seed derived plants of fusion parents and somatic hybrids. * Each single seed-derived plant was considered as one genotype.

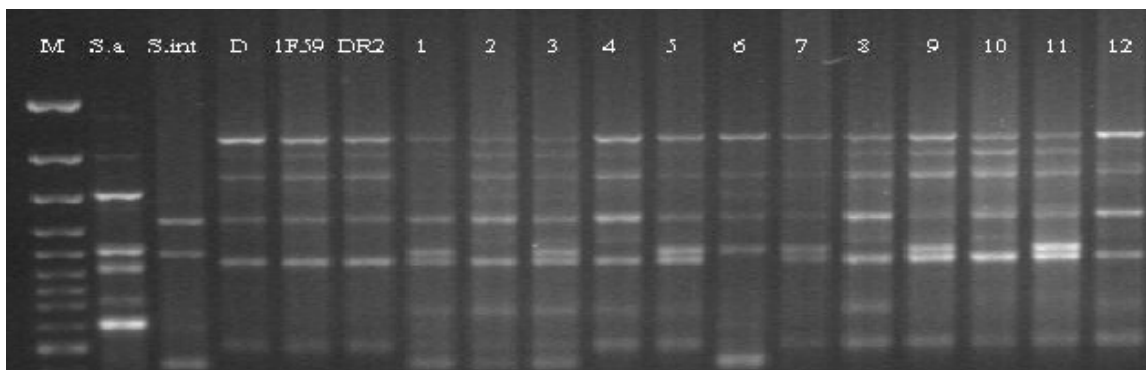

Figure 1. Amplification patterns of the fusion parents and 12 dihaploids derived from anther culture of the “double hybrid” using the UBC primer 834. M, 100 bp ladder plus.

Acknowledgements

Genotypes	Dutch strain				Italian strain			
	tested genotypes	total tested cuttings or plants	resistant genotypes	Suscept. genotypes	tested genotypes	total tested cuttings or plants	resistant genotypes	suscept. genotypes
Dourga	1	14	0	1	1	37	0	1
1F5(9)	1	24	0	1	1	34	0	1
<i>S. aeth.</i>	1	21	1	0	1	29	1	0
<i>S. int.</i>	1	26	1	0	1	60	1	0
D •Sa	5	24	5	0	3	40	3	0
1F5(9) • <i>S. int</i>	2	8	2	0	1	26	1	0
Double hybrids*	-	-	-	-	83	-	73	10
Dihaploids	91	600	64	27	125	921	93	32

This work was supported by the Italian Ministry of Agricultural Policy in the framework of the project PROMAR.

References

- Cappelli C., Stravato V.M., Rotino G.L., Buonauro R. 1995: Sources of resistance among *Solanum* spp. to an Italian isolate of *Fusarium oxysporum* f. sp. *melongenae*. In: Andrásfalvi A, Moór a., Zatykò (eds) EUCARPIA, 9th Meet Genet Breed Capsicum Eggplant. SINCOP, Budapest, pp 221-224.
- Collonnier C., Mulya K., Fock I., Mariska I., Servaes A., Vedel F., Yakovlev S.S., Souvannavong V., Ducreux G., Sihachakr D. 2001: Source of resistance against *Ralstonia solanacearum* in fertile somatic hybrids of eggplant (*Solanum melongena* L.) with *Solanum aethiopicum* L.. Plant Science. 160: 301-313.
- Comai L. 2000: Genetic and epigenetic interactions in allopolyploid plants. Plant Molecular Biology. 43: 387-399.
- Rizza F., Mennella G., Colonnier C., Sihachakr D., Kashyap V., Rajam M.V. Presterà M. Rotino G.L. 2002: Androgenid dihaploids from somatic hybrids between *Solanum melongena* and *Solanum aethiopicum* gr. *gilo* as a source of resistance to *Fusarium oxysporum* f.sp. *melongenae*. Plant Cell Reports. 20: 1022-1032.
- Rotino G.L., E. Perri, A. D'alessandro, G. Mennella, 1998: Characterization of fertile somatic hybrids between eggplant (*S. melongena* L.) and *S. integrifolium* Poir. Xth EUCARPIA Meeting on "Genetics and Breeding of *Capsicum* & Eggplant" 7-11 Sept. 1998 - Avignon (France), pp 213-217.
- Rotino G.L., Mennella G., Fusari F., Vitelli G., Tacconi M.G., D'Alessandro A., Acciarri N. 2001: Towards introgression of resistance to *Fusarium oxysporum* f. sp. *melongenae* from *Solanum integrifolium* into eggplant. XIth EUCARPIA Meeting on "Genetics and Breeding of *Capsicum* & Eggplant" 9-13 April - Antalya (Turkey), pp 303-307.
- Sihachakr D., Daunay M.C., Serraf I., Chaput M.H., Mussio I., Haicour R., Rossignol L., Ducreux G. 1994: Somatic hybridization of eggplant (*Solanum melongena* L.) with its close and wild relatives. In: Bajaj YPS (ed) Somatic hybridization in crop improvement (Biotechnology in Agriculture and Forestry Vol 1). Springer-Verlag, Berlin Heidelberg, pp 255-278

Molecular analysis of interspecific graft-induced variation in pepper (*Capsicum*)

Shiiguchi K.,¹ Ajiro T.,¹ Zhung Y.,² Cui S.,¹ and Hirata Y.¹

¹*Laboratory of plant genetic and breeding of Tokyo University of Agriculture and Technology, Tokyo, 183-8509, Japan. E-mail: genetics@cc.tuat.ac.jp*

²*Department of horticulture of Northeast University of Agriculture, Harbin, 150003, China*

Abstract: We have conducted interspecific grafting in pepper between *Capsicum baccatum* and *Capsicum annuum*. As a result, some progeny individuals derived from grafted scions showed intermediate or variant morphological characteristics of those of stocks and scions. CMV resistance that was exclusively processed by the stock was observed in progeny by infection test. In parallel, the sequence of the capsanthin-capsorubin synthase (CCS) gene cloned from the progeny was found identical to that cloned from the stock, but different from the scion in the Hap \square site, indicating that transformational event have occurred via grafting.

Keywords: *Capsicum*, CMV resistance, interspecific-grafting, RAPD

Introduction

We have been studying graft-induced genetic variations in pepper over 50 years (Yagishita, 1961a, b, Janos et al, 1998). Morphological and molecular analysis revealed that a probable mechanism of grafted-induced genetic change could be suggested as a transformational event (Hirata, 1979, Hirata et al., 1995). Recently, gene transfer phenomena were discovered in vascular system (Kan et al, 1993, Hirata et al, 1995). For further study on the mechanism of graft-induced variation, interspecific grafting was conducted between *Capsicum baccatum* (stock) and *Capsicum annuum* (scion) (Zhang, 2001). Some morphological characteristics of the stock, such as pointed shaped fruit were observed in the progeny derived from the grafted scion. In addition, some progeny specific bands were detected by RAPD analysis (Shiiguchi et al., 2003). In this paper, we describe the results of the analysis on some typical variants derived from interspecific grafting.

Material and methods

Plant material

Capsicum baccatum wild line LS340, LS1205 were used as a stock, graft-induced variant line D45-6 derived from ‘Yatsubusa’ (*C.annuum*) grafted on ‘Spanish Paprika’ (*C.annuum*) was used as scion.

Pathogen

CMV yellow strain (CMV-Y) maintained in infected pepper leaves was used for CMV infection test.

Results and discussion

Graft-induced variation in fruit shape

The typical characteristics of both stock and scion materials are listed in Table 1. In some cases, the fruit shape of grafted scion was similar to that of stock rather than that of scion, and was inherited to the selfed progenies. The ratio of fruit shape that was similar to that of stock in the progeny derived from grafted scion increased by repeat grafting (Fig. 1), indicating that the variant characteristics was stabilized by repeat grafting.

Table 1. Typical characteristics of material plant

Plant species	Line	Fruit shape	Fruit derection	Friuting habit
<i>Capsicum annuum</i>	D45-6	inverted (two-lobed)	Erect	fasciculated
<i>Capsicum baccatum</i>	LS340	pointed	Pendent	non-fasciculated
<i>Capsicum baccatum</i>	LS1205	pointed	Pendent	non-fasciculated

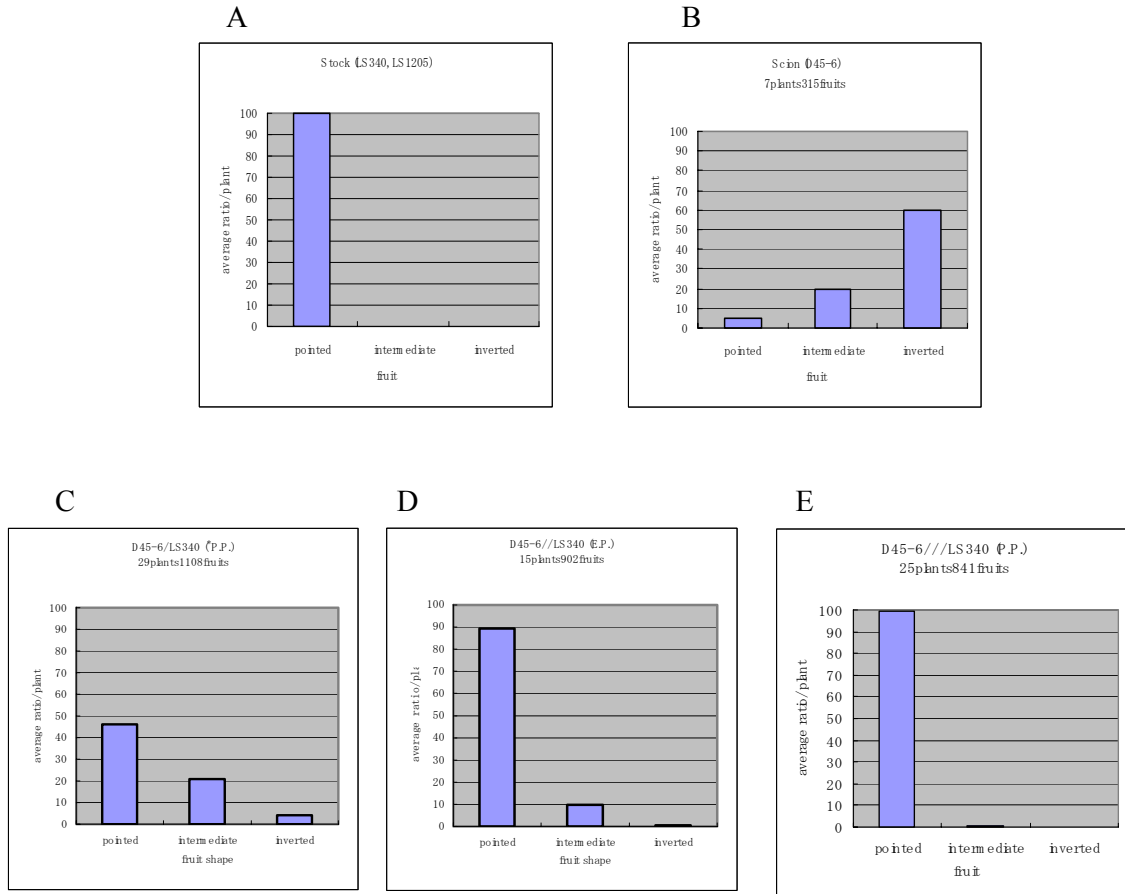

Figure 1. Distribution of fruit shape in the progeny derived from grafted scion. The ratio of pointed shaped fruit increased by repeat grafting (C:1time grafting, D:2times grafting, E:3times grafting). The pointed shaped fruit might be due to the introduction of characteristics on fruit shape of stock (A) into scion (B). *symbol in a parenthesis indicates the fruit characteristics of seed parent: P.P.=Pendent, Pointed E.I.=Erect, Inverted.

CMV infection test

The response against CMV was observed according to the morphological changes of the leaves that grew upper to the leaf that received infection in 3months. As were observed, some progeny plants had normal growth as those of the stock plants which were resistant to CMV. While the scion lines and some progeny plants displayed infected symptom of the CMV, indicating that some progeny plants had gained CMV resistance of the stock trait by grafting (Fig. 2).

Table 2. Result of CMV infection test

Tested line	No. of infected plant	Normal	Abnormal			
			Nortal	Malformed	Etiolation	Necrosis
<i>C.baccatum</i> (LS340)	4	4				
<i>C.annuum</i> (D45-6)	4			4		
<i>C.annuum</i> (E2)	4	1	1	2		
Wild type yellow	4	3	1			
Sweet pepper from China(2S)	4	2	1			1
Sweet pepper from China(2G)	4		4			
Pepper from Hungary	4		4			
G ₁ S ₂ -340	10	2	3	4	2	1
G ₁ S ₂ -1205	8	1	5		1	1
G ₂ S ₂ -340	10	2	4		1	3
G ₂ S ₂ -1205	10	1	2	5	1	1
G ₃ S ₂ -340	10	1	3	1		5
G ₃ S ₂ -1205	10	1		1	5	3

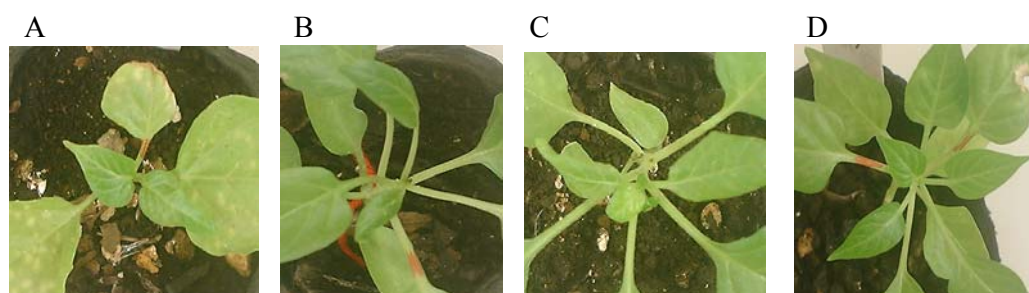

Figure 2 Morphological response against CMV infection

Morphological response was observed 3 month after CMV infection. No symptom was observed in LS340 (A) while the upper leaves showed atrophy in scion line, D45-6 (B) and progeny derived from 1st grafted scion (C). Significantly, a few progeny plants showed resistance against the virus which was an inheritable trait of the stock line (D).

Analysis on CCS gene sequence

Variation in pericarp color was found in the progeny derived from 1st grafted scion. The fruits of the variant line became orange before red in maturing stage, same as the stock line. This variation was also observed in the next generation suggesting the variation may have occurred at molecular level (Fig.3). Capsanthin-capsorubin synthase (CCS) was reported to be involved in maturing color in pepper (Lefevre et al., 1998). *CCS* gene fragment cloned from the variant line was analyzed and compared with those of stock and scion line. It showed that the sequence of the cloned *CCS* gene fragment from the stock and pericarp color variant line were identical, but different from that of the scion line at the *Hap* site region (Fig. 4). This result was further confirmed by PCR-RFLP (Fig. 5), suggesting that this variant trait was resulted from the introduction of stock trait into scion via grafting.



Figure 3 The comparison of the fruit between normal pericarp color and variant color line

```

LS340CCS 121 AGCAGTACACATTTTGTAGCTTTCTTGATTTAGCACCCACATCAAAGCCAGAGTCTTTA 180
D45-6CCS 121 AGCAGTACACATTTTGTAGCTTTCTTGATTTAGCACCCACATCAAAGCCAGAGTCTTTA 180
272CCS 121 AGCAGTACACATTTTGTAGCTTTCTTGATTTAGCACCCACATCAAAGCCAGAGTCTTTA 180
*****

LS340CCS 181 GATGTTAACATCTCATGGGTTGATACTGATCTGGACCGGGCTGAATTCGACGTGATCATC 240
D45-6CCS 181 GATGTTAACATCTCATGGGTTGATACTGATCTGGACCGGGCTGAATTCGACGTGATCATC 240
272CCS 181 GATGTTAACATCTCATGGGTTGATACTGATCTGGACCGGGCTGAATTCGACGTGATCATC 240
*****

LS340CCS 241 ATTGGAAGTGGCCCTGCCGGGCTTCGGCTAGCTGAACAAGTTTCTAAATATGGTATTAAG 300
D45-6CCS 241 ATTGGAAGTGGCCCTGCCGGGCTTCGGCTAGCTGAACAAGTTTCTAAATATGGTATTAAG 300
272CCS 241 ATTGGAAGTGGCCCTGCCGGGCTTCGGCTAGCTGAACAAGTTTCTAAATATGGTATTAAG 300
*****

```

Figure 4. The alignment of *CCS* gene fragment cloned from stock, scion and pericarp color variant line.

The underline indicates the digestion site of Hap II. Two sites exist in both stock line (LS340) and pericarp color variant line (272) while only one site exist in scion line (D45-6).

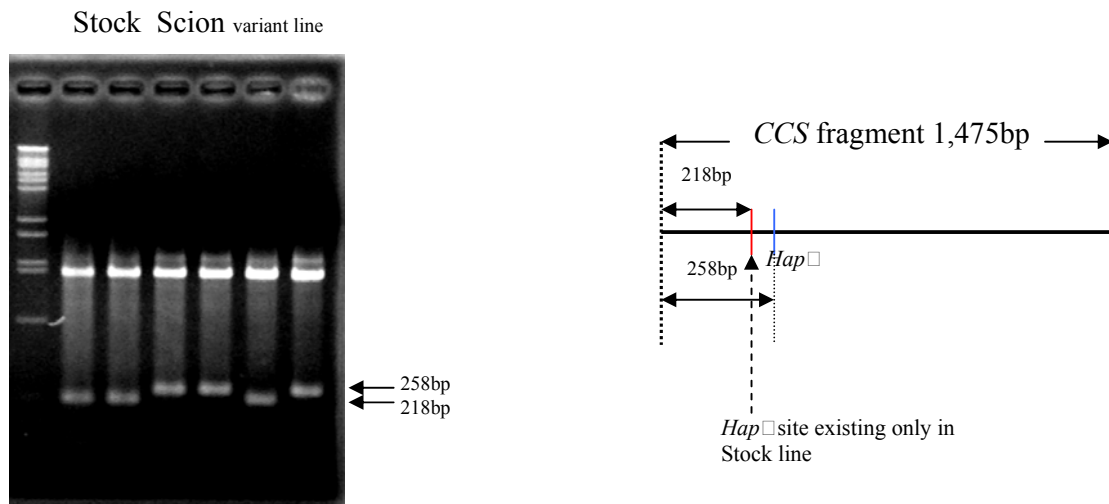

Figure 5. PCR-RFLP of *CCS* fragment digested by *Hap*I

References

- Hirata Y. and Yagishita N. (1993) Graft-induced genetic changes in red pepper (*Capsicum annuum* L.) Crop production and Improvement Technology in Asia, KSCS, Korea:599-604
- Kim M., Canio W., Kessler S. and Sinha N. (2001) Development changes due to long-distance movement of a homeobox fusion transcript in tomato Science vol. 293:287-289
- Lefevre V., Kuntz M., Camara B. and Palloix A. (1998) The capsanthin-capsorubin synthase gene: a candidate gene for γ locus controlling the red fruit colour in pepper Plant Molecular Biology 36: 785-789
- Taller J., Hirata Y., Yagishita N., Kita M. and Ogata S. (1998) Graft-induced changes and the inheritance of several characteristics in pepper (*Capsicum annuum* L.) Theor Appl Genet 97:705-713
- Taller J. (1999) Genetic analysis of the grafte-induced changes in pepper (*Capsicum annuum* L.) Faculty of agriculture, Tokyo university of agriculture and technology, Doctoral thesis: p111
- Yagishita N. and Hirata Y. (1986) Genetic nature of bushy plant type in the variant strain induced by grafting by grafting in *Capsicum annuum* L. Euphytica 35:17-23
- Yagishita N. and Hirata Y. (1987) Graft-induced change in fruit shape in *Capsicum annuum* L. I. Genetic analysis by crossing Euphytica 36:809-814
- Yagishita N. and Hirata Y. (1990) Genetic nature of low capsaicin content in the variant strains induced by grafting in *Capsicum annuum* L. Euphytica 46:249-252

Molecular analysis of Graft-Induced Variant Strain in Pepper (*Capsicum annuum* L.)

T.Ajiro, Y.Hirata, S.Ogata, K.Shiguchi and S.Cui

Laboratory of plant genetic and breeding of Tokyo University of Agriculture and Technology, Tokyo, 183-8509 Japan E-mail: genetics@cc.tuat.ac.jp

Plant grafting is an old and widely practiced vegetative propagation methodology since ancient time. In which, grafting method of 'Mentor-grafting' (Yagishita, 1964 ; Kasahara et al, 1978) was highly acceptable to induce graft-variations.

Yagishita (1964) has established graft-induced variant lines in pepper by five successive graftings between *Capsicum annuum* var. *grossum* Sendt (stock), and *Capsicum annuum* var. *fasciculatum* Irish (scion). The variant lines have been maintained by selfing for more than 50 generations.

Using these graft-induced variant lines, we have studied the genetic natures of graft variations (Hirata et al, 1984, 1990, 2001). The general characteristic of several graft-induced changes in the lines were investigated in a cross experiment. The results demonstrated that the new characters in the graft-induced variants were inheritable. However these characters were expressed in a different way from those in stock or scion cultivars.

We have analyzed the pepper graft-induced variant lines by RAPD and Southern blotting to detect the changes at the molecular level with an attempt to make clear the mechanism of the graft-induced changes (Taller et al, 1999; S.Ogata et al, 1999).

Some RAPD makers detected in the stock cultivar and in the graft-induced variants were absent in the scion cultivar. And some DNA fragments which were specific for both parent and 'hybrid' line were obtained. Significantly, the fragment of the Cytoplasmic specific gene *atp9* was also detected in the variant lines. Those clearly showed that graft-induced variant lines have inherited stock specific DNA molecule from the stock. Furthermore specific DNA fragments were also obtained in the graft-induced variant lines. This suggested that DNA rearrangement and other changes might have been occurred during the variant lines maintains. These findings supported the theory of direct DNA uptake into the gametes of the scion from the stock. The increasing of the variation ratio and the directed genetic changes will facilitate the possibility of graft transformation.

We are now studying the fate of the internal and transmitted DNA behaviors in the graft hybrid.

Factors affecting the *in vitro* organogenesis efficiency of Tunisian pepper and biolistic transformation essay

S.Arous^{1,3}, M.Boussaïd² and M. Marrakchi¹

¹ Faculté des Sciences de Tunis- Campus Universitaire- El Manar Tunis. Tunisie. ² Institut National des Sciences Appliquées et de technologies-Echrguia-Tunis. Tunisie. ³ Faculté des Sciences de Bizerte-Jarzouna-Bizerte. Tunisie. E-mail: aroussa@voila.fr

Pepper is one of the most important crops in Tunisia. Accordingly, great effort has been directed to its improvement.

In this work we report the influence of five factors: growth regulators, explant, embryo length, sucrose, and seed storage period, on the optimal shoot regeneration from Tunisian varieties. Our target is to obtain a performant *in vitro* regeneration protocol to apply genetic transformation methods on local culture. We first tested the published works. Unfortunately, only callus formation or explant necrosis were noted. Consequently, experiments for *in vitro* regeneration from Tunisian pepper were carried out.

Optimal shoot forming (organogenesis) was initiated from three Tunisian varieties: "Baker", "Beldi" and "D'hirat". During our investigations, we clearly noted that only the zygotic embryos have the ability to regenerate when they were cultured on MS medium supplemented with 5mg/l of BAP and 1mg/l of NAA. This ability varied greatly according to the explant length. Only embryos superior to 3mm in length were able to develop in the culture medium.

We tested the effect of sucrose on the established regeneration protocol. The efficiency of shoot forming depended on this factor. The optimal result was noted for the 30mg/l sucrose concentration.

We remarked also that the frequency of the organogenesis varied between the seed stocks. The ability to regenerate was studied according to the storage period from 0 days to 2 years. This ability decreased with the period of storage to reach 0%.

Based on all these observations, we determined the optimal parameters for the best *in vitro* bud forming from zygotic embryos and we were able to conduct transformation experiments. First, we screened the effect of three antibiotics: hygromycin, kanamycin and geneticin on pepper organogenesis inhibition to define the best selectable marker and the appropriate plasmid. Only hygromycin and kanamycin were able to inhibit bud forming. However, the hygromycin was the best we can use.

Transformation investigations using biolistic methods were conducted to estimate the zygotic embryo capacity for new gene integration. Optimal bombardment conditions were identified through GUS histochemical test. Explants cultured on the selectable medium did not regenerate in spite of the detection of a satisfying number of blue spots on the bombarded embryos. Currently, we continue our experiments to evaluate the efficiency of Tunisian varieties in the regeneration of transgenic plants.

Optimization of *Agrobacterium*-mediated genetic transformation of pepper (*Capsicum annuum* L.)

M. Delis¹, A. Nadolska-Orczyk² and K. Niemirowicz-Szczytt¹

¹Department of Plant Genetics, Breeding and Biotechnology, Warsaw Agricultural University, Nowoursynowska street 166, 02-787 Warszawa, Poland, ²Plant Breeding and Acclimatization Institute, Radzików, 05-870 Błonie

Pepper is highly susceptible to some fungal and viral pathogens. Since the source of resistance is not always available in cultivated varieties, genetic transformation is a suggested solution. However, just occasional instances of successful transformation events have been reported so far.

The aim of the study was to determine *Agrobacterium tumefaciens* strains, constructs and selection factors in order to develop transgenic plants of 'Bryza' variety with the use of in vitro agro-transformation method. The experiments employed the regeneration method from hypocotyl explants via organogenesis of shoot buds (Borychowski et al. 2002). In the first stage of experiments EHA 105 *Agrobacterium* strain harbouring plasmid pGPTV was used.

Four different selectable genes (*nptII*, *hpt*, *bar* and *dhfr*) were introduced in the plasmid, which allowed to compare the efficiency of the following selection agents: kanamycin, hygromycin, phosphinothricin and methotrexate. Adventitious bud formation was only observed on medium containing kanamycin (50 mg/dcm³) or phosphinothricin (0.75 mg/dcm³), but there was no plant regeneration. Therefore, in the second stage of *Agrobacterium* mediated transformation LBA 4404 strain containing pBI 121 (*nptII* and *uidA*) was tested. Buds developed into shoots, however, the result was better when kanamycin was applied with 7 days' delay. The explants producing shoots amounted on average to 15%. The molecular analysis (PCR) of regenerated plants is in progress.

Borychowski A., Niemirowicz-Szczytt K., Jędraszko M. 2002. Plant regeneration from sweet pepper (*Capsicum annuum* L.) hypocotyls explants. *Acta Physiologiae Plantarum* 24, 257-264.

Studies on the *in vitro* androgenesis in Chillies (*Capsicum annuum* L.)

Jasmine, J.A.P^{1,2}, S. D. Paulas³ and S. Thamburaj⁴

¹Agricultural College and Research Institute, Tamil Nadu Agricultural University, Killikulam, Vallanadu, Thoothukudi District, 628252, India.

²Email: jayajasmine2004@yahoo.co.in ³Department of Biotechnology, Tamil Nadu Agricultural University, Coimbatore, 641003, India. ⁴Former Dean (Horticulture), Horticultural College and Research Institute, Tamil Nadu Agricultural University, Coimbatore, 641003, India.

Chilli is an important commercial vegetable crop recognized for high yield, nutrient value and suitability for the manufacture of value added products. Studies on *in vitro* androgenesis in chillies was carried out at Horticultural College and Research Institute of Tamil Nadu Agricultural University, Coimbatore, India. Anther culture was tried in five genotypes of chillies viz., CA-25, CA-28, CA-45, CA-93 and CO-3. A cold shock treatment of flower buds (2.0 to 2.4 mm) at 4°C for 4 days enhanced the callus induction frequency. Surface sterilization of the explants with 70 per cent alcohol for 30 seconds followed by 0.1 per cent mercuric chloride for 5 minutes was found effective in minimizing contamination. Anthers were cultured in three types of basal media viz., MS, LS and VC media with (0 to 5 mg l⁻¹) 2, 4-D, NAA and IAA in combination with (0 to 5 mg l⁻¹) BAP and Kinetin for callus / embryoid formation. Callus induction was found to be better in VC medium and the genotype CA-25 responded the best with 2 mg l⁻¹ 2, 4-D + 0.5 mg l⁻¹ BAP. Pre-incubation in darkness at 35°C for 8 days followed by 16 hours photoperiod aided in callus induction and growth. Single strength media along with 8 g l⁻¹ agar, 3 per cent sucrose + single strength iron + 100 mg l⁻¹ glutamine promoted higher frequency of callus induction. Sigmoid growth pattern of callus proliferation was observed in VC medium containing 2 mg l⁻¹ 2, 4-D + 0.5 mg l⁻¹ BAP and the maximum growth occurred at 60 days while the lag phase started at 90 days. On aging there was reddening of callus indicating the presence of secondary metabolite. Greening of calli occurred on increasing the cytokinin concentration along with 500 mg l⁻¹ casein hydrolysate.

A new selection method for pepper transformation: Callus-Mediated Shoot Formation

Y.H. Lee¹, H.S. Kim¹, J.Y. Kim¹, M. Jung¹, Y.S. Park¹, J.S. Lee¹, S.H. Choi¹, N.H. Her¹, J.H. Lee¹, N.I. Hyung², C.H. Lee³, S.G. Yang¹ and C.H. Harn^{1*}

¹Breeding Institute, Nong Woo Bio Co., Ltd., Yeosu, Gyeonggi, Korea; ²Dept. of Horticulture, Sangmyung University, Cheonan, Chungnam, Korea; ³KT&G Central Research Institute, Yusong, Daejeon, Korea; *chharn@nongwoobio.co.kr

Two genes, *TMV-CP* and *PPII* (pepper-PMMV interaction 1 transcription factor) were used to transform commercially important chill pepper inbred lines (P915, P409) by *Agrobacterium* co-culture. Eighteen independently transformed T0 plants were obtained. The most critical point for the pepper transformation involved the selection of shoots growing on calli, referred to as callus-mediated shoot formation (indirect shooting), because shoots that were not grown from the callus (direct shooting from the wounded surface) turned out as nontransformants. In addition, the right callus type proved an important selection requirement for obtaining the transformed peppers. We found six different types of callus developed during the selection process. Shoots were generated from two of these types and one type regenerated shoots more significantly than the other type, suggesting that the shoot formation strength is callus type specific.

The transformation rate was low. However, this transformation method via callus-mediated shoot formation was reproducible. Transformation was confirmed by Southern and northern blot analyses. Based on the experimental data, a new protocol for selection and transformation of pepper was developed. We expect that this protocol would be used for pepper transformation.

Effect of selection for increased seed set and meiotic behaviour in colchicine induced autotetraploid chili pepper (*Capsicum annuum* L.)

V. Rattan Kumar, O. Anil Kumar, Y. Venkateswara Rao* and K.G. Raja Rao

Department of Botany, Andhra University, Visakhapatnam-530 003. India

**raoyechuri@yahoo.co.in*

The genus *Capsicum* a member of Solanaceae possess five cultivated and twenty wild species (Anonymous 1983). Members of the genus are almost cosmopolitan in distribution and are of considerable economic importance. *Capsicum annuum* L. is widely used as spice, condiment and a vegetable in most parts of the globe. Polyploidy has been the subject of intensive research for over several decades because of its key role in higher plant evolution. The realisation of far reaching effects of polyploidy in producing new and superior types of plants to the existing ones naturally led to experiments on the artificial production of polyploids. Further, induction of polyploids by experimental methods had been proved to be a handy tool in tampering with the genotypes of the organisms and in widening amplitude of variation in the gene pool. Polyploidy is also generally associated with gigantism in certain characters. In view of its importance as a cash crop, tetraploid was induced in *C. annuum* L. var. TNK through application of colchicine (0.3%) in our laboratory to garner the advantages that are associated with polyploids. In all six tetraploid plants survived till maturity. In these raw tetraploids (C₀) meiosis was irregular, pollen fertility and seed set per fruit was low due to irregularities. Generally researchers working with autotetraploid crop plants have always practised selection for higher fertility. Therefore, the selection has been practised on the raw tetraploids of the present study for increased seed set per fruit and the attendant cytogenetic changes for eight generations. The present study suggests that there was significant response for selection as revealed by increased seed set per fruit in each succeeding generation over the previous one. There was also an increase in the mean frequencies of bivalents, quadrivalents and chiasmata per cell, while univalent frequency decreased significantly in C₈ over C₀ generation. Further, it was found that regression of seed set on quadrivalent frequency, bivalent frequency and chiasma frequency per cell was positive and significant while the trivalent and univalent frequencies showed negative regression which is significant. Likewise regression of seed set on regular chromosome disjunction at anaphase I and the regular tetrad formation was found to be positive and significant. Thus it can be concluded that fertility in autotetraploid chili pepper can be improved with selection.

GENOME ANALYSIS

Occurrence and polymorphism of microsatellite repeats in the sequence databases in pepper

István Nagy, Zsuzsanna Sasvári, Anikó Stágel, Sándor Ács, Gyöngyi Bárdos

Institute of Genetics, Agricultural Biotechnology Center, Szent-Györgyi A u. 4. H-2100 Gödöllő, Hungary. Contact: inagy@abc.hu, Tel: +36 28 526100

A computer search of 23.174 entries belonging to the genus *Capsicum* of the EMBL sequence database yielded 1305 microsatellites. Among them 438 mononucleotide, 348 dinucleotide and 519 trinucleotide repeats were found. The most frequent repeat types were A/T mononucleotide repeats (420), followed by AG /TC dinucleotide repeats (240) and AAG/TTC trinucleotide repeats (139). The frequency of total number of *Capsicum* microsatellites were 5.6 % that represent on average 120.4 microsatellites per megabase pairs of DNA sequences. The dominance of trinucleotide repeats over dinucleotide repeats can be explained by the fact that more than 98 % of the *Capsicum* entries represented EST sequences, and trinucleotide repeats can be better tolerated in coding region than dinucleotide repeats that are far more frequent in non-coding regions.

The pool of all identified microsatellite containing entries was distilled by the criteria of redundancy and sequence quality and PCR primer pairs were designed in the case of 290 sequences. Based on primary functional tests 75 microsatellite markers were selected for more detailed investigations. Polymorphism tests were carried out on a set of genotypes including 14 varieties and inbred lines of *C. annuum*, 19 genotypes belonging to either of the species *C. baccatum* var. *baccatum*, *C. baccatum* var. *pendulum*, *C. chacoense*, *C. chinense*, *C. eximium*, *C. frutescens*, *C. pubescens*, *C. praetermissum*, as well as two tomato and one potato genotypes. Several new hypervariable microsatellite markers could be identified, displaying up to 8 alleles between genotypes within *C. annuum* and up to 10 alleles between different *Capsicum* species.

Table 2. Structure and information content of the new microsatellite markers

NR.	CODE	MICROSATELLITE MOTIF	ACCESSION NR. DESCRIPTION	MOST SIGNIFICANT HOMOLOGIES ¹			NR. OF ALLELES				CROSS-SPECIES TP MAP AMPLIFICATION POSITION ³
							within <i>Capsicum annuum</i> (14 genotypes)		across <i>Capsicum</i> sp. (33 genotypes)		
				pepper	tomato	potato		Size range, bp		Size range, bp	
1	EPMS303	(TA) ₂₅	BD076366 Gene promoter seq.	AX004525	BH012823		8	294-330	9	291-330	Lp
2	EPMS305	(CTT) ₃ (CAT) ₉	BM059622 KS01 C.annuum cDNA		BI926274	CK278805	3	97-103	8	94-115	Lp, Le
3	EPMS309	(CTT) ₆	BM061028 KS01 C.annuum cDNA		AW040246		3	248-268	7	248-283	St
4	EPMS327	(CGT) ₇	BM063302 KS01 C.annuum cDNA	CA523349	AW441453	BQ506266	3	107-114	6	98-114	Lp Gr6
5	EPMS330	(AT) ₁₀	BM063625 KS01 C.annuum cDNA	BM064283	AI486006	BI435779	3	265-271	6	257-271	
6	EPMS340	(AT) ₁₃	BM064640 KS01 C.annuum cDNA			BQ115704	2	260-269	9	250-281	
7	EPMS342	(CTT) ₇	BM064842 KS01 C.annuum cDNA	AY295081	BG130318	AW906944	5	323-343	7	323-343	
8	EPMS343	(CAT) ₆	BM064867 KS01 C.annuum cDNA		BQ515446		2	135-147	3	135-147	
9	EPMS345	(AAG) ₇	BM065407 KS07 C.annuum cDNA		BG642614	BQ121712	1	157	4	154-163	St
10	EPMS349	(GAT) ₆	BM066130 KS07 C.annuum cDNA			BM109649	2	223-235	5	223-235	St
11	EPMS350	(CAT) ₂ (CAA) ₇	BM066247 KS07 C.annuum cDNA	BM066498	BQ506610	BG596055	3	102-106	8	96-106	St
12	EPMS353	(CTG) ₆	BM067271 KS08 C.annuum cDNA	CA514870		CK265717	2	299-305	7	299-317	Gr1
13	EPMS366	(TA) ₈	CA514758 KS09 C.annuum cDNA		AI774693		1	182	7	171-196	Gr7
14	EPMS369	(CAT) ₂ ...(CAT) ₆	CA515055 KS09 C.annuum cDNA	CA514443		AJ272522	2	347-353	4	347-356	Lp,Le
15	EPMS372	(TA) ₈	CA515633 KS09 C.annuum cDNA			BQ515690	2	321-323	3	321-325	
16	EPMS374	(CAA) ₆ CAG(CAA) ₃	CA516096 KS09 C.annuum cDNA		BI932444	BE471989	1	212	5	206-215	Gr9
17	EPMS376	(CAA) ₆	CA516334 KS09 C.annuum cDNA	CA519255	AW443210	BM404104	4	246-256	6	243-259	Lp,Le,St
18	EPMS377	(AG) ₁₁	CA516439 KS09 C.annuum cDNA	CA522993	BE449276	BG600575	2	155-161	8	134-161	
19	EPMS378	(CGG) ₇ (AGG) ₂	CA516454 KS09 C.annuum cDNA	BM060513	AI773115		1	104	4	101-110	Gr1
20	EPMS381	(ACC) ₂ TCC(ACC) ₆	CA515954 KS09 C.annuum cDNA		BG643320	CK244611	1	166	1	166	
21	EPMS382	(ACA) ₉	CA517071 KS09 C.annuum cDNA			CK246344	1	166	5	154-166	Lp,Le
22	EPMS386	(CA) ₁₅	CA517699 KS09 C.annuum cDNA	CA517699			5	139-155	10	122-170	
23	EPMS387	(AAT) ₂ AGT(AAT) ₆	CA518417 KS10 C.annuum cDNA		AW622335		2	171-172	10	162-199	Lp
24	EPMS390	(ATT) ₈	CA519104 KS10 C.annuum cDNA		AI484478	BQ508386	2	113-115	5	113-127	
25	EPMS391	(AT) ₉	CA519548 KS10 C.annuum cDNA		AW647879		2	185-187	7	177-213	Le Gr10
26	EPMS395	(CCG) ₆	CA517669 KS09 C.annuum cDNA				2	124-130	7	116-131	
27	EPMS396	(CAT) ₆	CA521318 KS11 C.annuum cDNA	BM064361		BE923711	4	223-229	4	223-231	
28	EPMS397	(CA) ₂₀	CA521689 KS11 C.annuum cDNA	CA524222		BG350324	3	111-117	9	102-117	Lp,Le,St Gr1
29	EPMS399	(AAT) ₈	CA522816 KS12 C.annuum cDNA				3	156-159	8	144-175	
30	EPMS402	(CCT) ₃ (CTT) ₆ (CCT)	CA523427 KS12 C.annuum cDNA		AW617461	CK270861	4	201-207	7	198-206	Le
31	EPMS404	(CTT) ₁₂	CA524065 KS12 C.annuum cDNA		AY423549	BG096749	4	224-239	8	215-239	
32	EPMS409	(CAT) ₇	CA525246 KS12 C.annuum cDNA		BI203623	BM113158	3	162-175	6	162-180	
33	EPMS410	(CT) ₁₄ (CA) ₉	CA525390 KS12 C.annuum cDNA			BF188537	3	184-187	10	149-187	
34	EPMS411	(TA) ₆ (GATA) ₃	CA525873 KS12 C.annuum cDNA	CA523166			2	344-345	7	333-373	
35	EPMS412	(AT) ₉	CA526181 KS12 C.annuum cDNA	CA515332	AW039723	CK270992	2	205-207	5	205-213	
36	EPMS413	(CCA) ₉	CA526196 KS12 C.annuum cDNA	CA517403			1	258	5	252-369	
37	EPMS440	(CT) ₇	CA847460 CM334 Root cDNA	BM065600	AW039917	BE923988	1	178	2	178-192	Lp,Le
38	EPMS441	(AG) ₁₁	CA847465 mRNA; EST			BG592660	4	118-124	5	118-124	
39	EPMS448	(TAA) ₇	CB164897 mRNA; EST		AI486827	BQ517970	1	140	7	127-161	

						NR. OF ALLELES					
40	EPMS472	T16	BM061910 KS01 C.annuum cDNA	BM061826	AI491087	BI178058	3	293-320	6	289-320	Lp, St
41	EPMS480	C12A7	BM062655 KS01 C.annuum cDNA		BE432717		4	251-255	5	251-255	
42	EPMS484	C14A11	BM063454 KS01 C.annuum cDNA				2	135-144	3	135-144	
43	EPMS490	T17	BM066956 KS07 C. annum DNA		AW218125	CK248403	2	265-266	5	261-268	Lp
44	EPMS492	A7CA16	CA517063 KS09 C.annuum cDNA	CA519679	BE344400		1	195	3	187-202	
45	EPMS497	G14	CA522759 KS12 C.annuum cDNA				4	245-247	6	240-249	
46	EPMS501	T20	CA523558 KS12 C.annuum cDNA	CA516147			2	216-220	2	216-220	
47	EPMS507	A30	CB164833 KS05 C.annuum cDNA	CB164895			3	195-236	4	195-236	Lp, St
48	EPMS514	A19	CB185070 KS04 C.chinense cDNA	AF430372	AI486015	CK640735	2	250-252	3	250-254	

¹ The first hit listed. Only alignments above 100 score bits considered

² Lp: *Lycopersicon pimpinellifolium*, Le: *Lycopersicon esculentum*, St: *Solanum tuberosum*.

³ Position on the Tabasco x P4 map, Sasvári et al. in this issue

Construction of a new interspecific genetic map in pepper based on AFLP and microsatellite markers

Zsuzsanna Sasvári, Gyöngyi Bárdos, Sándor Ács, Anikó Stágel, István Nagy
*Institute of Genetics, Agricultural Biotechnology Center, Szent-Györgyi A u. 4.
 H-2100 Gödöllő, Hungary. Contact: inagy@abc.hu, Tel: +36 28 526100*

Abstract: We have constructed a new interspecific molecular map using an F₂ population from a cross between *C. frutescens* cv. Tabasco and the *C. annuum* inbred line P4 selected from the Hungarian spice pepper variety „Kalocsai 622”. AFLP analysis was carried out by semi-automated fluorescent technologies on ABI3100 capillary sequencers using 130 EcoRI/MseI primer combinations and 22 PstI/MseI combinations. Additional AFLP investigations were carried out by using 54 TaqI/AseI enzyme combinations on ALFexpressII sequencers. Segregation data were collected for 85 microsatellite markers and other sequence specific PCR based markers and for some phenotypic characters, like pungency, L2 type TMV resistance, fruit colour, corolla and pistill colour. After dropping out markers showing significant segregation distortion and tendency of clustering, 63 co-dominant PCR-based markers, 3 phenotypic characters and 278 AFLP markers could be positioned. The resulted map presently covers 1280 cM in 13 linkage groups with an average density of 14 cM/marker. The problems of distorted segregation, clustering and uneven distribution of AFLP markers between linkage groups, as well as the potential use of microsatellite markers for merging and integration of different genetic maps are discussed.

Keywords: *Capsicum annuum*, *Capsicum frutescens*, interspecific maps, AFLP, microsatellites

Introduction

Several intra- and inter-specific genetic mapping projects exist in *Capsicum* and efforts to integrate the available genetic maps is also in progress (Lefebvre, et al., 2002, Paran et al. 2002). The most critical problem in genetic mapping in pepper is the relatively low level of polymorphisms when progenies of intraspecific parental combinations are used. Interspecific mapping population usually display a higher level of polymorphism and allow the localization of significantly more markers.

Materials and methods

Plant material

An interspecific cross was made by using *Capsicum frutescens* cv. „Tabasco” as maternal and *C. annuum* „P4” as paternal parents. „P4” is an inbred line selected from the Hungarian spice pepper variety „Kalocsai 622”. One F₁ plant was selfed and an F₂ population (thereafter designated as „TP” population) consisting of 238 individuals was generated. F₂ plants were kept in the greenhouse. Prolongated life time of the F₂ individuals was achieved by grafting lateral shoots onto *Capsicum chinense* rootstocks. Leaves from greenhouse plants was collected for DNA isolation.

Phenotypic characters

F₂ individuals were screened for the following phenotypic characters that showed segregation in the interspecific population: growth habit (determined or

indetermined); corolla colour; pistill colour; immature fruit colour; pungency and L2 type resistance to Tobacco Mosaic Virus.

Marker analysis

Fluorescent AFLP analysis

Basic steps for AFLP reactions (restriction digestions, adapter ligation and preselective amplifications) were carried out according to standard protocols (Vos et al, 1995) with the exception that instead of radioactivity fluorescent labelling and detection was applied. For preselective amplifications primers with one selective nucleotides were used. In the case of EcoRI/MseI and PstI/MseI combinations FAM, JOE or NED labelled oligonucleotides were used as EcoRI and PstI specific primers with 3 selective nucleotides. AFLP polymorphisms were analyzed by running multiplex reactions on ABI 3100 capillary sequencers using ROX labelled internal size standards. Fragment analysis data were collected from capillary runs by standard built-in software from Applied Biosystems, converted to pseudogel-images and further analyzed by the Genographer program (Benham J.J., unpublished). In the case of a third type of enzyme/primer combination, TaqI/AseI digestions, adapters and primers were applied and CY5 labelled selective primers were used with 3 or 4 selective nucleotides. For these later cases AFLP reactions were analyzed after running on by ALFExpressII sequencers. Running data were converted to gel-images by the ALFwin Fragment Analyser software (Amersham Pharmacia Biotech) and evaluated visually.

SAMPL analysis

SAMPL (Selectively Amplified Microsatellite Polymorphic Loci, a modified AFLP procedure using microsatellite containing internal selective primers) analysis were conducted basically as described Witsenboer et al, (1997) with the exception that CY5 labelled selective primers were used and polymorphisms were investigated after running on ALFExpressII sequencers similarly to AFLP.

Microsatellite analysis

PCR reactions for microsatellite analysis were run under standard conditions. Microsatellite flanking forward primers were labelled by fluorescent compounds at their 5' -end: FAM, JOE, or NED labelled oligonucleotides were used for running on ABI 3100 sequencers and CY5 labelled primers for running on ALFExpress II sequencers. According to the applied running procedures, microsatellite polymorphisms were evaluated by the Genographer or by the ALFwin Fragment Analyser program.

Other co-dominant PCR-based markers

For sequence-specific PCR-amplifications primers were designed based on publicly available pepper sequences. Direct length polymorphisms or restriction polymorphisms of PCR fragments were analyzed after separation on high resolution agarose gels or polyacrylamide gels with subsequent silver stainings. SSCP analysis were carried out by running PCR products on flat-bed polyacrylamide gels (Multiphor II, Pharmacia) with subsequent silver staining.

Data acquisition and analysis

Genotypings for phenotypical characters was carried for each individuals. In the case of PCR-based markers usually parental and F₁ genotypes and 93 or more F₂ individuals were included. Statistical tests for the departure from the expected Mendelian segregation ratio were conducted in the case of non-AFLP markers. Linkage analysis was performed by the MAPMAKER/EXP v.3.0b program (Lincoln et al., 1992).

Results and discussion

Polymorphism test using the parental and F₁ genotypes of the „TP” population was carried out in the case of 478 sequence specific PCR-markers (206 microsatellite markers developed from own genomic libraries, 126 microsatellite markers developed from database sequences, 146 SSCP, CAPS or other PCR-specific markers). Polymorphisms and co-dominant character could be detected in the case of 85 markers (18 % from the total number of sequence-specific markers tested). For those markers genotypings of F₂ individuals were carried out. A total of 130 EcoRI/MseI AFLP enzyme/primer combinations were tested. 61 % of the EcoRI/MseI combinations proved to be polymorphic, the average number of polymorphic bands was 10 bands/primer combinations. A slightly higher level of polymorphisms could be detected in the case of TaqI/AseI enzyme/primer combinations (54 combinations): 65% of the combinations proved to be polymorphic, yielding 15 polymorphic bands/combinations in average. On the other hand, from 22 PstI/MseI combinations 49% detected polymorphisms between the parents, with an average number of 7 polymorphic bands/primer combinations.

All together, segregation data wer collected for 1071 loci. Markers showing a significant ($P > 0.01$) segregation distortion were excluded from the further analyses. The marker set was divided into linkage groups by the „group” command of the MAPMAKER program (parameters: LOD $> 3 < 25$ cM). As EcoRI/MseI AFLP markers showed an extremely uneven distribution between the linkage groups and they tended to build clusters at the central and terminal regions of the linkage maps, a framework map was constructed first from a subset of markers consisting of all co-dominant and phenotypic markers, as well as of PstI/MseI and TaqI/AseI AFLP markers and SAMPL markers by using the „order” command, with the parameters as above. EcoRI/MseI AFLP markers were added in more steps into the framework map via the „assign” command: First, markers with a tendency of heavy clustering were filtered out, leaving only one representative marker in each locus. The remaining AFLP markers were added to the framework map in two subsequent steps: first markers having dominant alleles in the maternal parent than the markers dominant in paternal parent were added. The resulting genetic map includes 278 markers in 13 linkage groups. The first 12 linkage groups are presented in the Figures 1. and 2. The 13. linkage group includes only 4 AFLP markers is not presented graphically. AFLP markers are designated by a code „A” followed by a number combination specific to the enzyme/primer set, to the individual fragments and donor parent. The code „S” stands for SAMPL markers, GPMS is for microsatellite markers generated from genomic libraries. Sequence-specific PCR markers investigated as either SSR-, SSCP-, CAPS-, or direct length-polymorphisms, are designated by the GeneBank/EMBL accession nr. of the target sequences. These later categories of co-dominant PCR-based markers are potentially the most interesting as they are easily

and quickly transferable to other genetic map and can facilitate the integration of the different maps. On the other hand, due to the relatively low resolution and low number of reference markers of our interspecific map, further efforts are needed to increase the density of markers in each linkage group. Automated fluorescent AFLP is a very effective technology for producing large number of genotyping data within a short time. However, as AFLP markers (and especially EcoRI/MseI markers) have a tendency for uneven distribution and clustering in pepper as well as in other Solanaceous species (Haanstra et al., 1999, Kang, et al., 1999), other type of markers (like microsatellites) are probably better candidates for the further saturation and integration of the existing pepper genetic maps. The increase of the available number of informative molecular markers is still a critical factor of the progress. Further, possible reasons of uneven marker distribution on the interspecific maps may also be the suppressing of recombination and cytogenetic abnormalities that frequently occur in progenies from wide crosses. We are working towards on marker development and on the further saturation of the interspecific map, as well as on the placing of common markers onto intraspecific pepper maps to address these questions.

Acknowledgements

This work was supported by the Hungarian Ministry of Education NKFP program „Gold of Hungaria”, grant Nr. 4/006.

References

- Benham ,J.J.: Genographer, Version 1.6.0. Software can be obtained from <http://hordeum.oscs.montana.edu/genographer>.
- Haanstra, J.P.W. Wye, C. Verbakel, H. Meijer-Dekens, F. Van der Berg, P. Odinet, P. Van Heusden, A.W. Tanksley, S. Lindhout, P. Peleman J. 1999: An integrated high-density RFLP-AFLP map of tomato based on two *Lycopersicon esculentum* × *L. penellii* F₂ populations. Theor. Appl. Genet. 99:254-271
- Kang, B.C. Nahm, S.H. Huh, J.H. Yoo, H.S. Yu, J.W. Lee , M.H. & Kim, B.-D. 2001: An interspecific (*Capsicum annuum* × *C. chinense*) F₂ linkage map in pepper using RFLP and AFLP markers. Theor Appl. Genet 102:531-539
- Lefebvre, V. Pflieger, S. Thabuis, A. Carantha, C. Blattes, A. Chauvet, J.C. Daubeze, A.M. & Palloix, A 2002: Towards the saturation of the pepper linkage maps including known-function genes. Genome 45:839-854
- Lincoln, S. Daly, M. & Lander, E.: Constructing Genetic Maps with MAPMAKER/EXP 3.0. (1992) Whitehead Institute Technical Report. 3rd edition.
- Livingstone, K.D. Lackney, V.K. Blauth, J.R. Van Wijk, R. C. & Jahn, M.K. 1999: Genome mapping in *Capsicum* and evolution of genome structure in *Solanaceae*. Genetics 152:1183-1202
- Paran, I. Lefebvre, V. Van der Voort, J.R. Landry, L. Van Wijk, R. Tanyolac, B. Caranta, C. Ben Chaim, A. Livingstone, K. Jahn, M. Palloix, A. Peleman , J. 2002: An integrated genetic linkage map of pepper (*Capsicum* spp.) Plant, Animal & Microbe Genomes X Conference January 12-16 2002, San Diego, CA, U.S.A.

- Vos, P. Hogers, R. Bleeker, M. Reijans, M. Van der Lee, T. Hornes, M. Frijters, A. Pot, J. Peleman, J. Kuiper, M. Zabeau, M. 1995: AFLP: a new technique for DNA fingerprinting. Nucl. Acids Res 23: 4407-4414
- Witsenboer, H. Vogel, J. Michelmore, R.W. 1997: Identification, genetic localization, and allelic diversity of selectively amplified microsatellite polymorphic loci in lettuce and wild relatives (*Lactuca* spp.). Genome 40:923-936

An integrated approach of mapping, BAC library and candidate gene cloning for chili molecular breeding

Byung-dong Kim*, Je-Min Lee¹, Eun-Young Yoo¹, Dong-Hwan Kim¹

¹ Department of Plant Science, and Center for Plant Molecular Genetics and Breeding Research, Seoul National University, Seoul 151-742, Korea

*Corresponding author: Phone: 82-2-880-4933, Fax: 82-2-873-5410, E-mail: kimbd@snu.ac.kr, http://plaza.snu.ac.kr/~mglab/en_frame.htm

Abstract: In an effort to lay a ground of molecular breeding for chili pepper an integrated approach has been made with mapping, BAC library construction and candidate gene cloning. By using an interspecific cross population between *Capsicum annuum* cv. TF68 and *C. chinense* cv. Habanero, 516 markers, mainly of RFLP and SSR, were developed from genomic and cDNA clones, and from EST database. Combination of mapping and candidate gene approach was effective in identifying several important genes. The fruit color of orange ‘Habanero’ was investigated genetically and was shown to cosegregate with the marker *psy* encoding phytoene synthase. To identify *C* locus determining the pungency, placenta-specific cDNA clones were isolated from a highly pungent cultivar ‘Habanero’ using the suppression subtractive hybridization (SSH) method and were mapped onto the interspecific map. Out of the SSH clones, sb2-66, encoding putative capsaicin synthetase, was identified and its BAC clone isolated and sequenced. Current status of the research will be presented.

Keywords: Linkage map, *Capsicum annuum*, Bacterial Artificial Chromosome (BAC) Library, pungency, phytoene synthase (*psy*)

Introduction

Pepper fruits are consumed as food additives for their unique color, pungency, and aroma in many regions of the world. Five species of the genus *Capsicum*, *C. annuum*, *C. chinense*, *C. baccatum*, *C. frutescens* and *C. pubescens*, are cultivated in different parts of the world. Among them *C. annuum* is most widely grown in both Asia and worldwide. It includes most of the Mexican chili peppers, most of the hot peppers of Africa and Asia, and various cultivars of sweet peppers grown in temperate regions of Europe and North America.

During the last decade, the construction of molecular linkage map has become an essential tool for plant molecular genetics and breeding research. All of published genetic maps of *Capsicum* so far have been based on either interspecific populations (Tanksley et al. 1988; Prince et al. 1993) or intraspecific populations (Lefebvre et al. 1997) with the use of tomato-derived RFLP probes. Livingstone et al. (1999) published another genetic map containing nearly a thousand DNA markers. Nevertheless, the linkage map is only moderately saturated and many markers were distinctly clustered. Prince et al. (1993) suggested that sparsely mapped genomic regions may correspond to regions of the pepper genome which have diverged more rapidly from tomato, so are not detectable with tomato probes.

Here we report 1) the construction of a molecular linkage map of pepper using mainly pepper-derived probes based on a population of 107 interspecific F₂ individuals, 2) construction of 15x pepper BAC library and 3) candidate gene approach for functionally important genes.

Results

1) *Pepper linkage map*

Pepper has large genome size and, therefore, it is needed to integrate several different approaches for functional marker development. General approach of our research is to construct a molecular linkage map based on RFLP and SSR for high-resolution mapping and to develop molecular markers as pepper breeding tools. By using an interspecific cross population between *Capsicum annuum* 'TF68' and *C. chinense* 'Habanero', 516 markers were developed from genomic and cDNA clones, and from EST database.

2) *Pepper BAC library*

A BAC library of fifteen times haploid genome equivalents was constructed from *Capsicum annuum*, 'CM334' which is resistant to *Phytophthora capsici* and Potato virus Y. The BAC library consists of 313,336 clones with an average insert size of 130 kb. Screening of the library with mitochondrial DNA probes (*coxII*, *coxIII*, *atp6* and *atp9*) and chloroplast DNA probes (*atpB*, *rbcL*) indicated that contamination with cytoplasmic DNA was less than 0.5%.

3) *Candidate gene approaches*

- **Fruit color**

Using an interspecific cross population between *Capsicum annuum* 'TF68' and *C. chinense* 'Habanero' the mature fruit color determined by carotenoid pigments was investigated genetically. The orange fruit color of 'Habanero' was shown to cosegregate with *psy* encoding phytoene synthase on the carotenoid biosynthesis pathway. A point mutation on a splice site in *psy* was detected and thought responsible for the orange fruit color.

- **Pungency**

Pungency is one of the most important properties of chili pepper. Genetic analysis of pungency of pungency showed that *C* gene control pungency in a qualitative manner. To identify *C* locus determining the pungency, placenta-specific cDNA clones were isolated from a highly pungent cultivar 'Habanero' using the suppression subtractive hybridization (SSH) method and were mapped onto the interspecific map. Out of the SSH clones, sb2-66, encoding a putative capsaicin synthetase (*PCS*) was identified, and its BAC clone was isolated and sequenced. Current status of the research will be presented. Non-pungent pepper had a 2,489 bp deletion in an upstream region including the transcription start codon of *PCS*.

Male sterility (MS)

Male sterility is very important for F₁ hybrid seed system. In an attempt to develop the transgenic male sterile plant, the ribosome inactivating protein (RIP) gene that was isolated from *Dianthus sinensis* L by Cho et al.(2001) was constructed with an anther specific promoter (TA29) and were used to transform *Nicotiana Xanthi*. Transgenic male sterile tobacco were successfully developed.

To isolate and characterize the gene associated with the CMS trait in chili pepper, Southern, Northern, RT-PCR experiments were performed between a male sterile line and a male fertile line. As a result, a new open reading frame (*orf456*) was detected

from 3' region of *coxII* gene in the male sterile pepper. We tried to transform this *orf456* into *Arabidopsis thaliana* with mitochondrial targeting presequence.. Transgenic *Arabidopsis* plants showed the male sterile phenotype. (see poster presentation).

Conclusions

We have constructed pepper linkage map using RFLP and SSR markers for high resolution mapping. Fifteen-times genome equivalent BAC library was constructed for map-based cloning of functionally important genes in pepper. Concisely, genes on the biosynthetic pathways for carotenoid and capsaicinoid were located on SNU linkage map. Orange fruit color of Habanero cosegregated with *psy* gene which had a point mutation at a splice receptor site. Pungency gene *C* cosegregated with a candidate gene, putative capsaicin synthetase (*PCS*). Non-pungent pepper had a 2,489 bp deletion in an upstream region including the transcription start codon of *PCS*.

Acknowledgements

This research was supported by a grant from Agricultural Research Promotion Center (ARPC) and a grant from the Center for Plant Molecular Genetics and Breeding Research (CPMGBR) through Korea Science and Engineering Foundation (KOSEF).

References (Kim BD lab on pepper)

- Cho, HJ, Kim SJ, Kim, MW, Kim, BD. 2001. Production of Transgenic Male Sterile Tobacco Plants by Using the cDNA Encoding a Ribosome Inactivating Protein in *Dianthus sinensis* L. Mol. Cells 11:326-333
- Huh JH, Kang BC, Nahm SH, Kim S, Ha KS, Lee MH, Kim BD. 2001. Candidate gene approach identified phytoene synthase as the locus for mature fruit color in red pepper (*Capsicum* spp.). Theor. Appl. Genet. 102:524-530
- Kang BC, Yu JW, Lee MH, Kim BD. 1997. Applicability of AFLP on Hot Pepper Genetic Analysis. J Korean Soc Hort Sci 38:698-703
- Kang BC, Nahm SH, Huh JH, Yoo HS, Kim BD. 2000. Construction of a molecular linkage map in hot pepper. Acta Horticulturae 521:165-171
- Kang BC, Nahm SH, Huh JH, Yoo HS, Lee MH, Kim BD. 2001. An interspecific (*Capsicum annuum* x *C. chinense*) F₂ Linkage Map in Pepper Using RFLP and AFLP Markers. Theor Appl Genet. 102:531-539
- Kim, BD, Kang, BC, Nahm, SH, Kim, BS, Kim, NS, Lee, MH and Ha, KS. 1997 Construction of a molecular linkage map and development of a molecular breeding technique. J Plant Biol 40:156-163
- Kim DH, Kang JG, Kim SJ, Kim BD. 2001. Identification of *cox* and *atp6* regions as associated to CMS in *Capsicum annuum* by using RFLP and long accurate PCR. J Korean Soc Hort Sci 42:121-127
- Kim MW, Kim SJ, Kim SH, Kim BD. 2001. Isolation of cDNA clones differentially accumulated in the placenta of pungent pepper by suppression subtractive hybridization. Mol Cells 11:213-219

- Kim SH, Kim YH, Lee SW, Kim BD, Ha KS. 1997. Analysis of chemical constituents in fruits of red pepper (*Capsicum annuum* L. sv. Bugang). J Korean Soc Hort Sci 38:384-390
- Lee JM, Nahm SH, Kim YM, Kim B.D. 2004. Characterization and molecular genetic mapping of microsatellite loci in pepper. Theor. Appl. Genet 108:619-627
- Nahm SH, Yu JW, Kang BC, Kim BD. 1997. Election of Parental Lines for Hot Pepper Mapping population using RFLP and AFLP Analyses. J Korean Soc Hor. Sci 38:693-697
- Yoo EY, Kim SJ, Kim JY, Kim BD. 2001. Construction and characterization of a bacterial artificial chromosome library of chili pepper. Mol Cells 12:117-120
- Yoo EY, Kim S, Kim YH, Lee CJ, Kim BD. 2003. Construction of a deep coverage BAC library from *Capsicum annuum*, 'CM334'. Theor Appl Genet 107:540-543

Figure 1. SNU-2 pepper map consisting of 46 SSRs and 287 RFLPs. The linkage groups (1-12) were labeled according to synteny of tomato markers described in Livingstone et al. (1999) and Chaim et al. (2001), and other groups were arbitrarily labeled according to total map distance of each linkage group. On the left of the vertical double lines are map distances in cM calculated by Kosambi function and on the right are DNA markers by identification numbers and names. Marker types and designations are as follows: pepper SSRs (*Hpms*, *CM*, and *GenBank accession number*); pepper genomic RFLP (PST); pepper cDNA RFLP (PCD, DC, and CDI); pepper secondary metabolite biosynthesis genes RFLP (PSY, GPS, PDS, LCY, CCS, TK2, CRTHYD, PFTF, COMT, PAL, Ca4H, PCS, and pAMT); pepper EST RFLP (CAN, CFR and CLF); pepper MADS genes RFLP (hpMADS and MADSP10); pepper defence related genes RFLP (DD19, CaPR, CaLTP and N32); pepper rDNA RFLP (RDNA); tomato genomic RFLP (TG); tomato cDNA RFLP (CT and CD); tobacco cDNA RFLP (X03913 and M29869). Uppercase letters at the end of the marker names indicate that the marker is one of at least two segregating loci detected by a single assay. (after Lee JM et al. 2004. Theor. Appl. Genet 108:619-627)

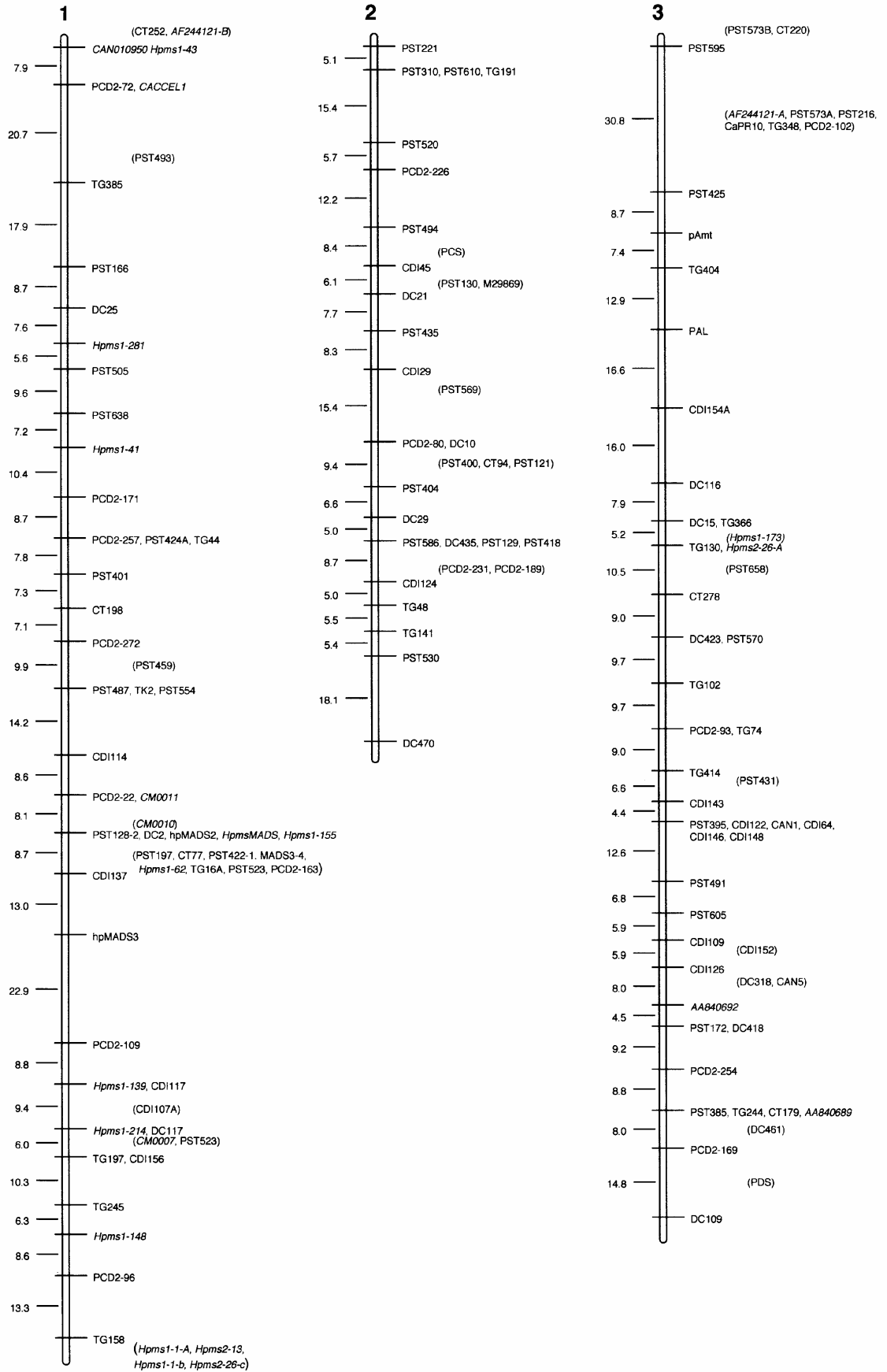

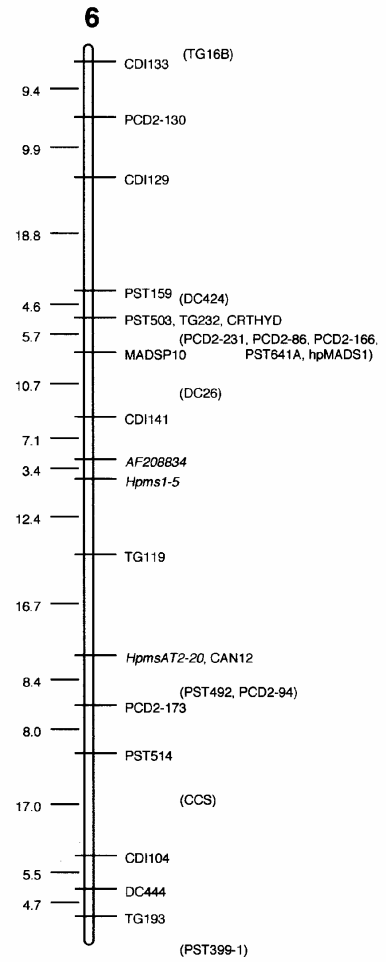
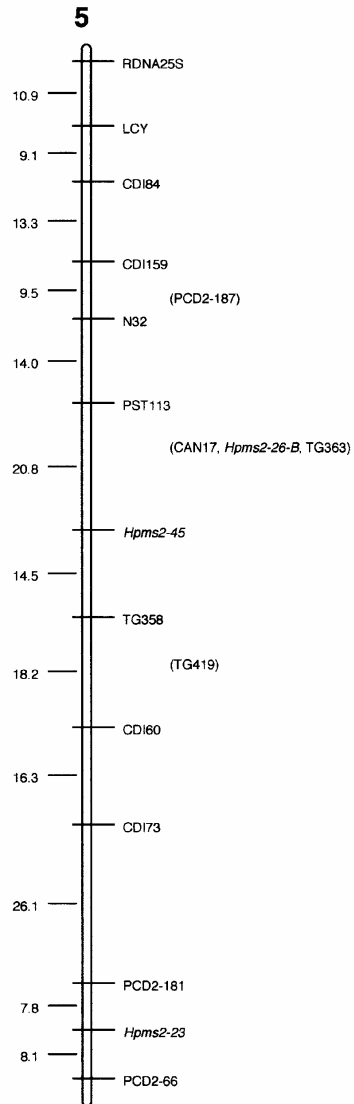
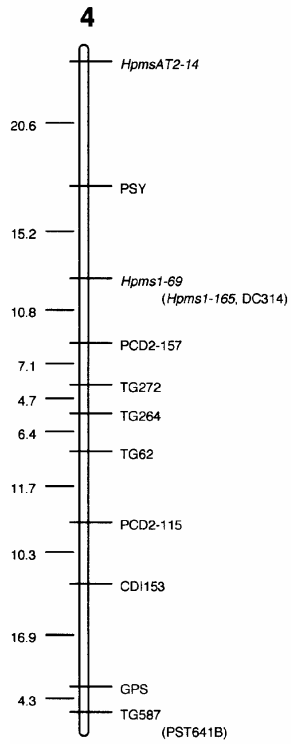

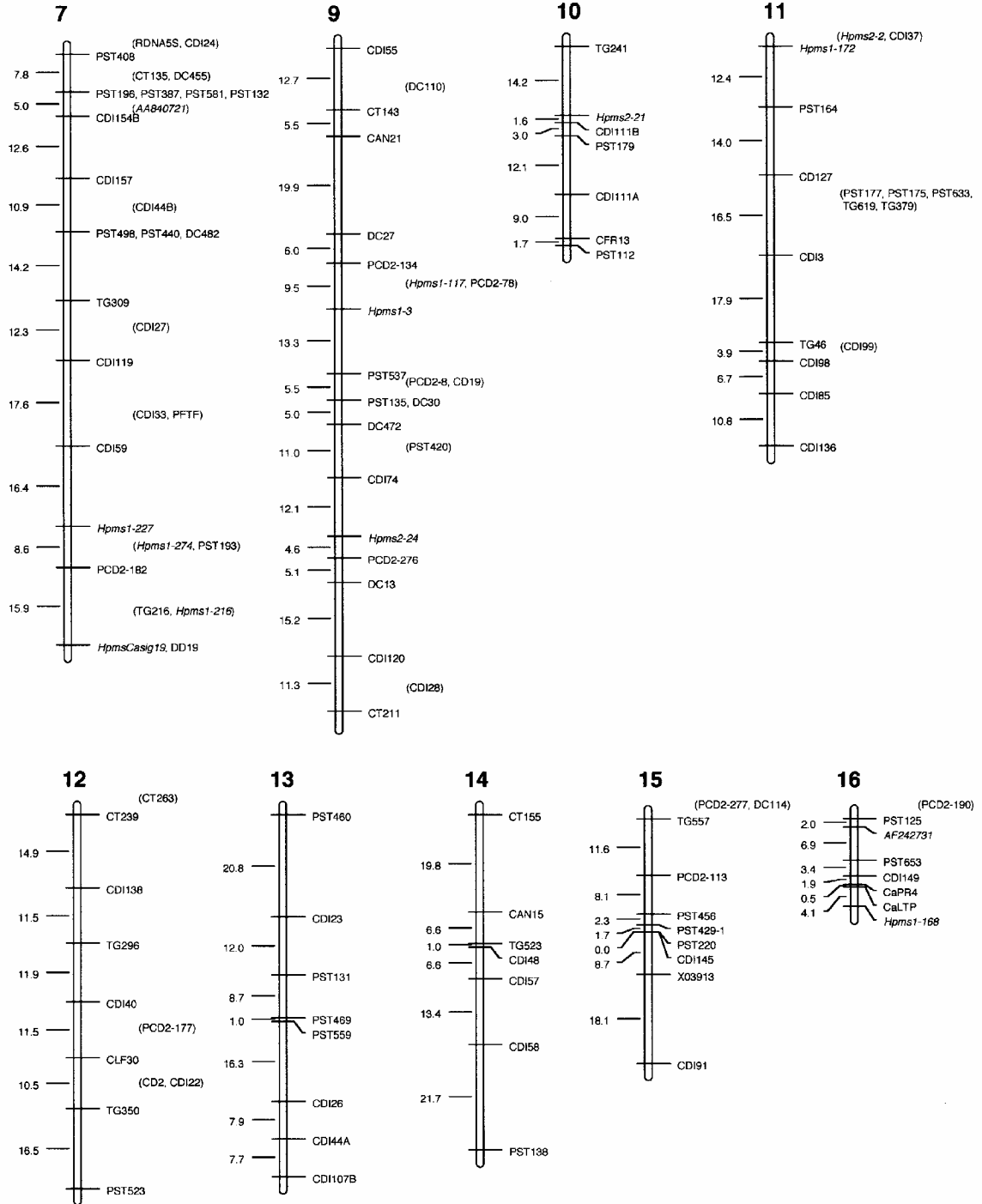

Comparative QTL mapping of fruit weight and shape in pepper and tomato

Ilan Paran¹, Arnon Ben Chaim¹, Shachar Ziger¹, Yelena Borovsky¹, G. U. Rao¹ and Dani Zamir²

¹ Department of Plant Genetics and Breeding, Agricultural Research Organization, The Volcani Center, Bet Dagan, 50250, Israel. ² Department of Genetics, Faculty of Agriculture, The Hebrew University of Jerusalem, Rehovot, 76100, Israel. Contact: iparan@volcani.agri.gov.il, Tel: 972-3-9683943

Abstract: Comparative QTL analysis for fruit weight and shape was performed in four mapping populations of pepper and tomato. The pepper data were extracted from previous QTL studies from crossing of the large-fruited cultivar Maor (*Capsicum annuum*) with the small-fruited accessions Perennial (*C. annuum*) and BG 2816 (*C. frutescens*). The tomato QTL data were derived from the analysis of two introgression line populations of *Lycopersicon pennellii* and *L. hirsutum*. Twelve and 31 fruit weight QTLs and 7 and 21 fruit shape QTLs were detected in pepper and tomato, respectively. Most fruit weight (61%) and fruit shape (82%) QTLs were found as unique to a single cross of pepper or tomato. While 27% of fruit weight QTLs were conserved in both genera, all fruit shape QTLs were unique in each genus. These results indicate that while a large fraction of the genetic variation in fruit weight is controlled by the same genetic factors in both pepper and tomato, the genetic control of fruit shape evolved independently in these genera. Only three QTLs for fruit weight in chromosomes 2, 3 and 4 were found as common in all four pepper and tomato populations. We initiated high-resolution comparative mapping of these putative orthologous QTL by constructing pepper introgression lines for the QTL regions. For pepper chromosome 2, we detected a single major fruit weight QTL that may correspond to tomato *fw2.1*. For pepper chromosome 4, we detected two linked fruit weight QTL, of which one, (*fw4.2*), may correspond to tomato *fw4.2a*.

Keywords: comparative mapping, pepper, tomato, fruit weight, fruit shape.

Introduction

The fruit is the main commodity of important Solanaceae crops such as tomato, eggplant and pepper. Fruit weight and fruit shape are among the major traits that were under selection during domestication of these crops. While the wild fruits are typically small and round, the cultivated plants bear large fruits with diverse shapes. The genetic control of fruit weight and fruit shape was studied most extensively in tomato and QTLs controlling these traits were identified in several crosses involving cultivated and wild parents (Grandillo et al. 1999). These studies allowed the recent positional cloning of two major QTLs controlling fruit weight (*fw2.2*) and fruit shape (*ovate*) in tomato (Frary et al. 2000; Liu et al. 2002). In pepper, QTLs for fruit-related traits were identified in two recent mapping studies involving crosses of the same blocky-type parent, Cv. Maor (*Capsicum annuum*) with small-fruited *C. annuum* and *C. frutescens* accessions (Ben Chaim et al. 2001; Rao et al. 2003). The phenotypic similarity in the fruit traits, the use of common experimental methods and personnel and the use of common RFLP markers to map QTL in pepper and tomato allowed to perform comparative QTL analysis for these traits in the two species.

Materials and methods

Plant material

Pepper QTLs were obtained from previously published data of two mapping populations. The first population (termed AA) was derived from an intra-specific cross of *C. annuum* between the blocky-type inbred cultivar Maor and the small-fruited accession Perennial (Ben Chaim et al. 2001). The mapping population consisted of 180 F₂ individuals, while F₃ progenies were used for trait measurements. The second population (termed AF) was derived from an advanced backcross progeny of the cross of Maor and the wild *C. frutescens* accession BG 2816 (Rao et al. 2003). The mapping population consisted of 248 BC₂ individuals, while BC₂S₁ progenies were used for trait measurements. For tomato, two whole-genome introgression lines (IL) populations of *Lycopersicon pennellii* (termed LP) and *L. hirsutum* (termed LH) were used (Eshed and Zamir, 1995; Monforte and Tanksley, 2000). The LP population was constructed by crossing *L. pennellii* LA 716 to M82 as donor and recurrent parents, respectively and it consists of 75 lines, each containing a single introgression with an average length of 30 cM. The LH population was constructed by crossing *L. hirsutum* LA 1777 and E6206 as donor and recurrent parents, respectively and it consists of 50 lines, each containing a single introgression with an average length of 30 cM.

For the construction of pepper chromosomes 2 and 4 introgression lines, we used *C. chinense* PI 152225 as a donor and the *C. annuum* blocky-type inbred 100/63 as a recurrent parent. By a series of backcrossing and marker-assisted selection we generated BC₂S₃ homozygous lines IL-37 and IL-315 that contain introgressions of most of chromosomes 2 and 4, respectively. Except for the targeted chromosomes, these lines are isogenic to 100/63. We then crossed these ILs with 100/63 and prepared F₂ populations for each IL. These F₂ populations were used to construct a RFLP map of the chromosomes and to conduct QTL analyses.

Field experiments, trait evaluation and QTL analysis

The procedures for the two years of field experiments of the pepper AA and AF populations were described by Ben Chaim et al. (2001) and by Rao et al. (2003). The tomato LP population was grown in the open field in Akko, Israel, in the summer of 2001 and 2002, while the tomato LH population was grown in Akko in the summer of 2001. For all introgression lines populations, the experimental design was a randomized complete block design with six replications, each replication consisted of single plant. Fruit weight, length, width and shape (ratio of length to width) were measured from three mature fruits per plant by similar procedures and by the same personnel as described by Ben Chaim et al. (2001).

QTLs for fruit weight and shape in the pepper AA and AF populations were obtained by interval analysis as described by Ben Chaim et al. (2001) and by Rao et al. (2003), respectively. For QTL determination in the introgression lines, the means of the lines were contrasted with their isogenic controls by Dunnett test ($P \leq 0.05$) by means of the JMP v. 3 software (SAS Institute 1994). An introgression line was considered as containing a QTL only if significant effects were detected in both experiments. When a QTL was detected in two overlapping introgression lines, the location of the QTL was assumed to be in the overlapped region. When QTL were mapped in a common interval defined by the same RFLP markers in different populations, it was considered as the same QTL.

Results and discussion

Comparative QTL mapping in pepper and tomato

Because of a space limit, a detailed description of the QTLs detected in all the pepper and tomato populations cannot be provided. In summary, 16 and 15 QTLs were detected for fruit weight in the tomato LP and LH populations, respectively. Ten and 11 QTLs were detected for fruit shape in the tomato LP and LH populations, respectively. In pepper, 5 and 7 QTLs were detected for fruit weight in the AA and AF populations, respectively. For fruit shape, 3 and 4 QTLs were detected in the AA and AF populations, respectively. These data defined a total of 26 unique fruit weight QTLs and 22 unique fruit shape QTLs in both pepper and tomato.

Most fruit weight QTLs (61%) were detected in only one out of the four populations. 27% of fruit weight QTLs were found in both pepper and tomato, however, only 3 QTLs in chromosomes 2, 3, and 4 were detected in all 4 pepper and tomato populations. These conserved QTLs can be considered as orthologous. In contrast, most fruit shape QTLs (82%) were detected in only one out of the four populations and none was detected in both genera. This indicates that both convergent and divergent selections were operated on fruit weight QTLs in pepper and tomato during domestication while a divergent selection was operated on fruit shape QTLs in these species.

The three putative orthologous QTL are candidates for further fine mapping and eventual cloning. Towards this goal we generated pepper introgression lines containing these QTL (Figure 1) and confirmed the QTL locations in F₂ populations (Figure 2 and Figure 3). For chromosome 2, we constructed the introgression line IL-37. Interval QTL analysis in an F₂ population of a cross between IL-37 and 100/63 identified a single major QTL for fruit weight at the tomato fruit shape gene *Ovate* (LOD=13.6, R²= 62%) (Figure 2). This raises the possibility that fruit weight and shape may be controlled by the same genetic factors, or alternatively tightly linked genes control the two traits. In tomato, high resolution mapping using the LP introgression lines revealed the presence of three linked fruit weight QTL in the south of chromosome 2 (Eshed and Zamir, 1995). The pepper fruit weight QTL is likely to correspond to tomato *fw2.1*. While *fw2.2* plays a major role in the genetic control of fruit weight in tomato, its effect in pepper is much less significant. No QTL was detected for fruit shape in IL-37.

For chromosome 4, we constructed the introgression line IL-315. Interval QTL analysis in an F₂ of this IL identified two QTLs for fruit weight, *fw4.1* at T819 (LOD= 4.6, R²= 17%) and *fw4.2* at TG500 (LOD= 7.1, R²= 28%) (Figure 3). While for pepper *fw4.1*, no corresponding QTL was identified in tomato, pepper *fw4.2* could correspond to the QTL detected in the present study in the LH population. Furthermore, in a high resolution mapping experiment using *L. hirsutum* introgression lines, two linked fruit weight QTL were detected in the south of chromosome 4 (Monforte et al. 2001). The first, *fw4.2a* located between TG555 and CT50 could correspond to pepper *fw4.2* as TG500 is located within the tomato QTL interval. The second QTL, *fw4.2b*, was located in the interval CP57-TG464 in which no pepper QTL was found. For fruit shape, a single QTL, *fs4.1*, located in the same position as *fw4.1* at T819 was identified (LOD= 4.5, R²= 17%).

References

- Ben Chaim A, Paran I, Grube R, Jahn M, van Wijk R, Peleman J (2001) QTL mapping of fruit related traits in pepper (*Capsicum annuum*). *Theor Appl Genet* 102: 1016-1028
- Eshed Y, Zamir D (1995) An introgression line population of *Lycopersicon pennellii* in the cultivated tomato enables the identification and fine mapping of yield-associated QTL. *Genetics* 141:1147-1162
- Frary A, Nesbitt TC, Frary A, Grandillo S, van der Knapp E, Cong B, Liu J, Meller J, Elber R, Alpert KB, Tanksley SD (2000) *fw2.2*: A quantitative trait locus key to the evolution of tomato fruit size. *Science* 289:85-88
- Grandillo S, Ku HM, Tanksley SD (1999) Identifying the loci responsible for natural variation in fruit size and shape in tomato. *Theor Appl Genet* 99:978-987
- Liu, J, Van Eck J, Cong B, and Tanksley SD (2002) A new class of regulatory genes underlying the cause of pear-shaped tomato fruit. *Proc. Natl. Acad. Sci. USA* 99, 13302-13306
- Livingstone KD, Lackney VK, Blauth J, Wijk VR, Jahn MK (1999) Genome mapping in *Capsicum* and the evolution of genome structure in the Solanaceae. *Genetics* 152:1183-1202
- Monforte A, and Tanksley SD (2000) Development of a set of near isogenic and backcross recombinant inbred lines containing most of the *Lycopersicon hirsutum* genome in a *L. esculentum* genetic background: A tool for gene mapping and gene discovery. *Genome* 43: 803-813
- Monforte A, Friedman, E, Zamir, D and Tanksley SD (2001) Comparison of a set of allelic QTL-NILs for chromosome 4 of tomato: deductions about natural variation and implications for germplasm collection. *Theor Appl Genet* 102: 572-590
- Rao GU, Ben Chaim A, Borovsky E, Paran I (2003) Mapping of yield related QTLs in pepper in an inter-specific cross of *Capsicum annuum* and *C. frutescens*. *Theor. Appl. Genet.* 106: 1457-1466.

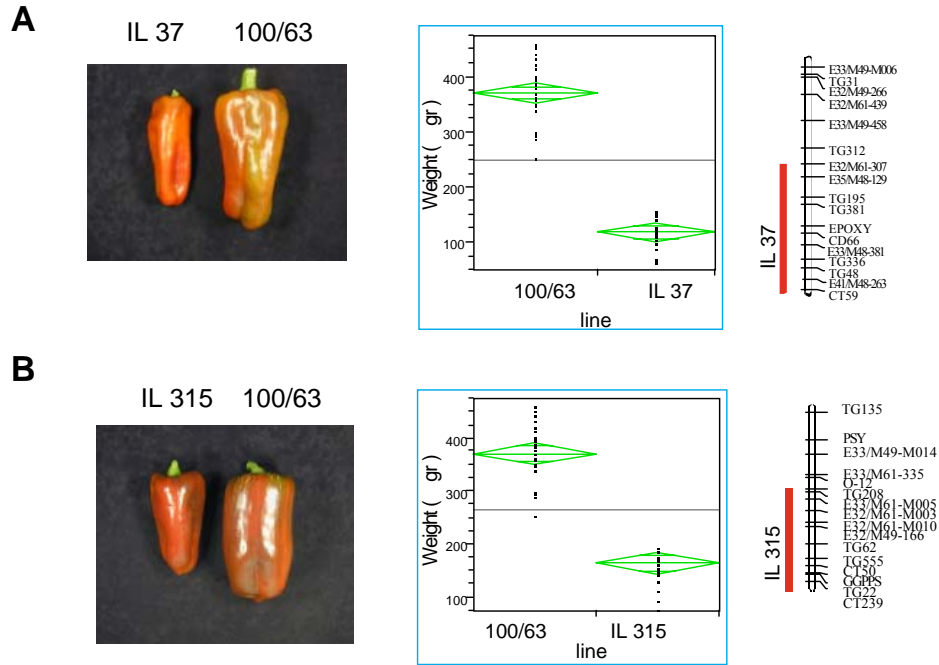

Figure 1. Use of *C. chinense* introgression lines to map QTLs for fruit weight and shape in chromosomes 2 (A) and 4 (B).

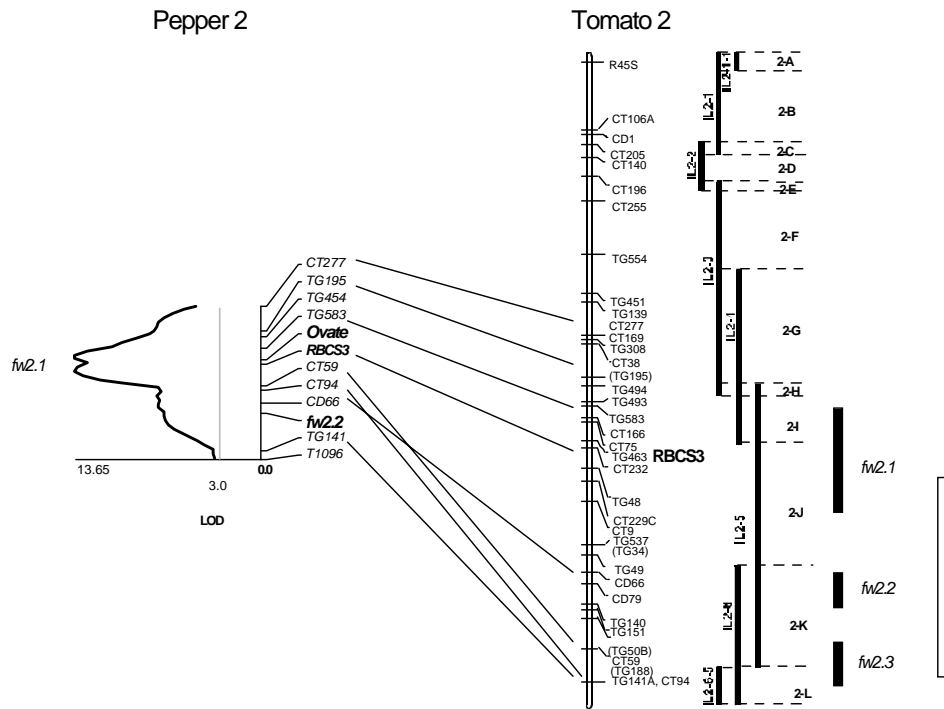

Figure 2. Comparative mapping of fruit weight QTL in chromosome 2 of pepper and tomato. Black and empty bars to the right of the tomato map represent QTL identified in the LP and LH introgression lines populations, respectively.

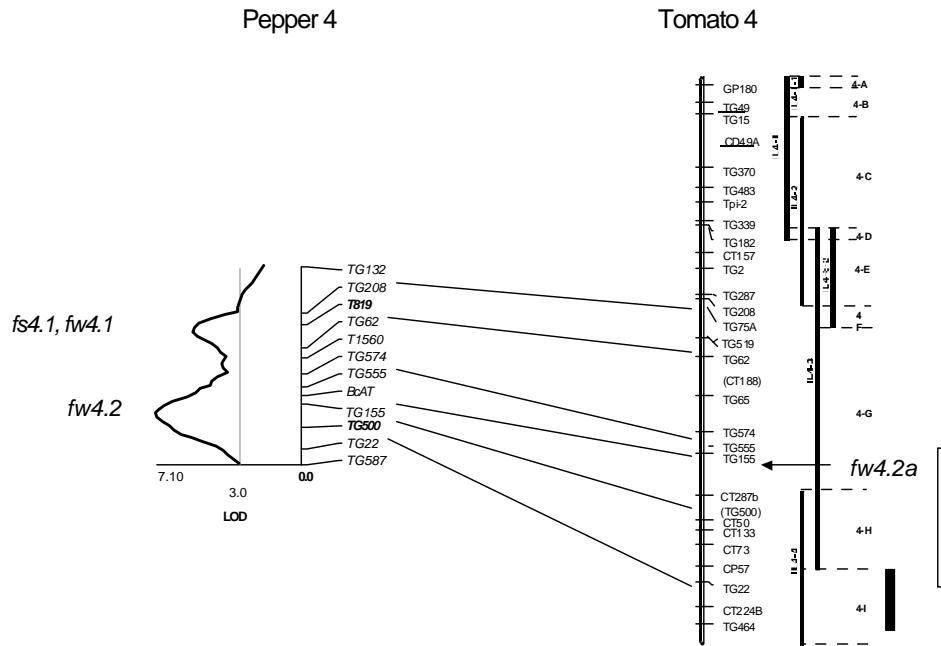

Figure 3. Comparative mapping of fruit weight QTL in chromosome 4 of pepper and tomato. Black and empty bars to the right of the tomato linkage group represent QTL identified in the LP and LH introgression lines populations, respectively.

Comparative genetics and genomics of disease resistance in the Solanaceae

Byoung-Cheorl Kang, Michael Mazourek, Liz Cerulli, Ed Quirin and Molly Jahn

Dept. of Plant Breeding

Cornell University

Ithaca, NY 14853

The plant family Solanaceae defines the broadest comparative genetic system in the dicots. We have used comparative approaches to study the structural and functional divergence of resistance genes. Previously, we have shown that R genes occur in syntenous clusters in *Lycopersicon*, *Solanum*, and *Capsicum*. This talk will summarize recent results from our comparative genetic and genomic studies of disease resistance genes. Many NBS-LRR R genes have been cloned from Solanaceae. Results from our analyses indicate R gene specificity, that is which pathogen taxa are controlled by a particular gene, diverges much more rapidly than general resistance function. In contrast to NBS-LRR R genes, *Pto* still defines a unique resistance gene subclass. We have isolated functional homologs of this tomato gene from two *Capsicum* species considered non-hosts to *Pseudomonas syringae* pv. *tomato* that show 99% amino similarity to *L. pimpinellifolium Pto*, along with *Capsicum* homologs of most of the known tomato homologs.

Yeast two-hybrid interaction assays indicated the possibility of functional conservation. Transient expression of *AvrPto* confirmed that both *Capsicum* species specifically recognize this molecule resulting in a characteristic hypersensitive response. The implications of these results for prevailing models of genome evolution and R gene mechanisms will be discussed. In addition to the dominant R gene studies, we also have studied recessive resistance genes in pepper. Recessive resistance is especially prevalent for potyviruses, comprising approximately 40% of all known resistance.

Many of these genes have been used successfully for decades in crop breeding programs as effective and stable sources of resistance. We identified the *Capsicum* resistance gene *pvr1* and the results will be presented.

SNPs development in pepper

A. Acquadro^{1,2}, P. Donini³, D. Lee³, C. Comino¹, E. Portis¹ and S. Lanteri¹

1Di.Va.P.R.A. Plant Genetics and Breeding, University of Turin, via L. da Vinci 44, I-10095 Grugliasco (Turin), Italy.

2 alberto.acquadro@unito.it. 3NIAB - MRG, Huntingdon road, Cambridge, CB3 0LE, UK

Single Nucleotide Polymorphism markers offer great potential for high genome coverage and high throughput analysis in both MAS and basic studies. The identification of SNPs for targeting quality traits, QTLs and disease resistance genes is already advanced on a number of major crops.

We report on a study aimed at the detection of SNPs, by REF-SSCP, in genes coding for well-studied enzymes in *Capsicum annuum* L. Fifteen genes from *C. annuum* were selected from the NCBI database for SNP mining. In a preliminary screening we analysed, for each gene, one fragment of about 450 bp originating from a region overlapping the intron-exon junctions. Fifteen pairs of PCR-primers were designed and employed for the amplification of such sequences in 7 pepper species (*C. annuum* L., *C. chinense* L., *C. frutescens* L., *C. pubescens* L., *C. chacoense* L., *C. baccatum* L., *C. tovarii* L.) and in 10 commercial varieties of *C. annuum* provided by Nunhems Zaden (NL).

PCR products were analysed by REF-SSCP for the presence of point mutations in different samples, i.e.: the amplification products were digested with MseI or AluI, then denatured to yield single-stranded DNA fragments and rapidly cooled down to 0°C; the ssDNA fragments were separated on polyacrylamide gels and silver stained. Polymorphic fragments were then sequenced for SNP discovery.

Validation of the identified SNPs was carried out by ‘tetra primer ARMS PCR’, which employs two primer pairs to amplify, respectively, the two different alleles of a SNP in a single PCR reaction. Briefly: two primers (‘outer’) were constant and flanked the SNP, while the other two were designed precisely on the mutation, with the 3' terminal residues specific for the wild type allele (‘forward inner’) or for the mutant allele (‘reverse inner’). By positioning the two ‘outer primers’ at different distances from the SNP, the two allele specific PCR products differed in length and might be detected by gel electrophoresis. Primers were designed using the software made available on line http://cedar.genetics.soton.ac.uk/public_html/primer1.html.

The three steps (REF-SSCP, sequencing, tetra ARMS PCR) strategy proved to be efficient for the detection and characterisation of SNPs in pepper. The SNPs developed showed to be suitable for discriminating among *Capsicum* species as well as for variety fingerprinting within *C. annuum*.

The *A* locus that controls anthocyanin accumulation in pepper encodes a MYB transcription factor homologous to *Anthocyanin2* of *Petunia*

Y. Borovsky¹, M. Oren-Shamir², R. Ovadia², W. De Jong³ and I. Paran^{1,4}

¹ *Department of Plant Genetics and Breeding, Agricultural Research Organization, The Volcani Center, P. O. Box 6, Bet Dagan, 50250, Israel.* ² *Department of Ornamental Horticulture, Agricultural Research Organization, The Volcani Center, P. O. Box 6, Bet Dagan, 50250, Israel.* ³ *Department of Plant Breeding, 252 Emerson Hall, Cornell University, Ithaca, NY 14853, USA.* ⁴ *Email: iparan@volcani.agri.gov.il*

Pepper plants containing the dominant *A* gene accumulate anthocyanin pigments in the foliage, flower and immature fruit. We previously mapped *A* to pepper chromosome 10 in the F₂ progeny of a cross between 5226 (purple-fruited) and PI 159234 (green-fruited) to a region that corresponds, in tomato, to the location of *Petunia Anthocyanin2* (*An2*), a regulator of anthocyanin biosynthesis. This suggested that *A* encodes a homolog of *Petunia An2*. By using the sequences of *An2* and a corresponding tomato EST, we isolated a pepper cDNA orthologous to *An2* that cosegregated with *A*. We subsequently determined the expression of *A* by Northern analysis using RNA extracted from fruits, flowers and leaves of 5226 and PI 159234. In 5226, expression was detected in all stages of fruit development as well as in flower and leaf. In contrast, *A* was not expressed in the sampled tissues in PI 159234. Genomic sequence comparison of *A* between green and purple-fruited genotypes revealed no differences in the coding region, indicating that the lack of expression of *A* in the green genotypes can be attributed to variation in the promoter region. By analyzing the expression of the structural genes in the anthocyanin biosynthetic pathway in 5226 and PI 159234, it was determined that similar to *Petunia*, the early genes in the pathway are regulated independently of *A*, while the expression of the late genes is *A*-dependent.

Hybrid identification with microsatellite markers

Gémes Juhász A¹, Stágel A², Zatykó L¹, Nagy I²

(1) *Vegetable Crops Research Institute Budapest, Hungary, H-1775 P.O.B. 95.*

(2) *Agricultural Biotechnology Centre, Gödöllő*

The proper genotype identification and variety protection is particularly important problem in Hungary and world-wide. There is a large set of special Hungarian sweet pepper varieties and red paprika powder- a typical and traditionally important export. During the last years the demand for fingerprinting techniques that enable the proper identification and protection of valuable Hungarian varieties, land-races and breeding material have been continuously increasing. Using molecular markers the possible combinations of lines available for hybrid breeding increase to an enormous extent, while the time and cost required for the incorporation of traditional phenotype markers become unnecessary.

A special problem in pepper genome analysis is that the cultivated varieties show an extremely low level of polymorphism when conventional genotyping systems like isoenzymes, RFLPs or RAPD are used. Simple sequence repeat- or microsatellite markers (SSR) offer a solution of this problem, as they are highly polymorphic and abundant in the whole genome. In the past years in the Agricultural Biotechnology Centre, Gödöllő, Hungary) isolated approximately 400 microsatellite markers from pepper by screening of short insert genomic libraries from the pepper variety Fehérözön and Blondy with different repetitive oligonucleotides.

Lately about 80 microsatellite markers were tested for polymorphism between parental and F₁ genotypes of 11 pepper hybrid combinations of the 'VCRI' pepper breeding program.

Till now from these about 13 markers proved to be useful to distinguish between the parents of at least one hybrid combinations. The suitable markers per hybrid combinations varied between 1 and 6. Some markers are capable to distinguish in more than one hybrid combination at the same time. We compared our results of microsatellite test with known data of hybrid percent which were identified testing for morphological characters (phenotypic anthocyanin) or for TMV virus resistance. Microsatellite markers gave consistent and reliable results. The reproducibility was excellent and the automated laser sequencer offer is ideal for large-scale analysis.

The highly polymorphic markers proved to be very useful tool in purity test of parent lines.

Supported by Hungarian Research and Development Programs (NRDP) „Gold of Hungaria” 2001/ 2001/4/006

Identification of a mitochondrial gene associated with cytoplasmic male sterility (cms) in pepper (*capsicum annuum* L.)

D.H. Kim, B.D. Kim*

Department of Plant Sciences, College of Agriculture and Life Sciences, and Center for Plant Molecular Genetics & Breeding Research, Seoul National University, Seoul, 151-742, Korea

** Corresponding author: Tel.: 82-2-880-4933 Fax: 82-2-873-5410. E-mail: kimbd@snu.ac.kr.*

The expression of a mitochondrial CMS-associated gene, *orf456*, was uniquely detected by RT-PCR and Northern blot analysis in cytoplasmic male sterile (CMS) pepper. In bacterial growth inhibition assay, growth rate of bacterial cells was impaired when ORF456 protein was expressed in *E. coli* cells. To investigate the role of ORF456 protein in plant mitochondria, we have transformed arabidopsis plants with mitochondria-targeted *orf456* constructs. Mitochondria targeting was visualized by GFP fused with mitochondrial targeting signal (*coxIV* presequences) and Mitotracker dye (Molecular Probe Co. USA) in the onion transient expression experiments. Transgenic arabidopsis infiltrated with mitochondria-targeted constructs (*coxIV-orf456*) showed sterile phenotype in transgenic plants while non-targeted constructs had no difference in phenotype in comparison to wild type plants. The *orf456*-coding region was placed under the control of the CaMV 35S promoter. Expression of *orf456* gene was detected by RT-PCR analysis.

Development of microsatellite markers in eggplant

T. Nunome^{1,2}, I. Kono³, N. Namiki³, H. Kanamori³, K. Suwabe¹, A. Ohyama¹, H. Fukuoka¹

¹ National Institute of Vegetable and Tea Science (NIVTS), 360 Kusawa, Ano, Mie 514-2392, JAPAN. ² E-mail: nunome@affrc.go.jp ³ Institute of the Society for Techno-innovation of Agriculture, Forestry and Fisheries (STAFF), 446-1 Ippaizuka, Kamiyokoba, Tsukuba, Ibaraki 305-0854 JAPAN

The potential of microsatellites has been evaluated to use in genetic studies of eggplant (*Solanum melongena* L.). A genomic library of eggplant was screened for GA and GT repeats. The results indicated that GA and GT repeats occurred every 3200 and 820 kb in the eggplant genome respectively. All the microsatellite-containing clones were sequenced, and PCR primers were designed from the flanking regions of the microsatellites. A total of 23 primer pairs amplified the expected microsatellite region. The level of polymorphism was evaluated by using *S. melongena* lines and related *Solanum* species. Two to six alleles per primer pair were displayed in the *S. melongena* lines and 2 to 13 alleles in the *Solanum* relatives. Seven microsatellites were found to show polymorphism between parental lines of the mapping population and segregated in a codominant Mendelian manner.

For large-scale analysis of microsatellite, genomic libraries enriched in fragments containing di- and tri-nucleotide repeat motifs were constructed in eggplant. Small-scale random sequencing of the libraries revealed that more than 87% of the clones in each library contained microsatellite(s). In large-scale sequencing, all the sequence data was assembled by Phred/Phrap and subjected to redundancy test by BLAST algorithm to be found that from 22% to 42% of the sequenced clones were independent (uniclone) in each library. Combination of a simple perl script for detecting microsatellite region and Primer3, a PCR primer picking-up program, enabled automatic marker development from uniclone sequence data. More than 80% of the primer pairs designed using the pipeline was successful in amplification of the expected microsatellite region. Unexpectedly, it was found that several primers designed for AAC microsatellites have an identical sequence even though they were designed for different uniclones. It was due to a common sequence adjacent to AAC microsatellite region and the sequence shared a high homology to Ts, a tobacco short interspersed repetitive element (SINE). The result suggests that the existence of a common sequence adjacent to microsatellite should be checked when primers are designed. Out of the sequence-tagged microsatellite regions, 33 has been mapped at present. Large-scale development of microsatellite markers and construction of microsatellite-based linkage map in eggplant is now underway.

RAPD Analysis of Cytoplasmic Male Sterile Gene in hot pepper (*Capsicum annuum* L)

Deyuan Wang^{1,2}, Qiumiao Yin¹, and Ming Wang³

¹*Vegetable Institute, Guangdong Academy of Agricultural Sciences, Guangzhou 510640, PRC.* ² *Email: wdy168@163.net.* ³*College of Horticulture, Northwest Agri-forest Sci-Tech University, Shaanxi 712100, PRC.*

RAPD system for hot pepper (*Capsicum annuum* L) was established, i.e. based on Williams *et al* system, RAPD reaction mixtures were composed of 20 ng DNA/25 μ L reaction, obtained by the modified liquid N₂-SDS procedure, and 1.5 m mol/L MgCl₂. According to the isogenic line analysis theory, RAPD analysis of cytoplasmic male sterile line 93-A and its maintainer line 93-B was conducted using the aboved optimum system. The results showed that the marker OPK-17₅₅₀ and OPK-17₁₅₀₀ were correlated with CMS gene in the line 93-A, marker OPH-11₂₀₀₀ was associated with maintainer gene in the line 93-B. Partial sequencing revealed that OPH-17₅₅₀ could be 5' part of certain chloroplast gene.

AUTHOR INDEX

- Abak, 181
 Acciarri, 178, 196, 203
 Acquadro, 247
 Ács, 224, 227
 Adamowicz, 122
 Adetula, 51
 Ajiro, 210, 216
 Alberti, 203
 Alekseev, 94
 Arens, 54
 Arnedo Andrés, 121, 134
 Arous, 217
 Arpaia, 196
 Aubert, 108
 Ayme, 139
 Babatola, 51
 Bal, 93
 Balaram, 192
 Baral, 32
 Barchi, 55
 Bárdos, 224, 227
 Barendse, 108
 Basavaraja, 52, 86
 Ben Chaim, 239
 Ben-Chaim, 100
 Bendahmane, 167
 Bernard, 66
 Berthou, 180
 Bhalekar, 61, 84
 Blanca, 38
 Blattes, 161
 Bodson, 131
 Bonnet, 161
 Borovsky, 100, 239, 248
 Bosland, 32
 Boudet, 161
 Boukema, 44, 54, 60
 Boussaïd, 217
 Buyukalaca, 53
 Cakir, 181
 Caranta, 139, 154, 167
 Cerulli, 246
 Chadoeuf, 139
 Chae, 62, 85
 Chawla, 92
 Cheong, 85
 Chetti, 123
 Chezhiyan, 124
 Cho, 85, 179
 Choi, 220
 Comino, 247
 Csillery, 147
 Cui, 210, 216
 Cvikic, 63, 187
 D'Alessandro, 196, 203
 Danan, 161
 Daskalov, 94
 Daubèze, 66, 73
 Daunay, 108, 122, 154, 167
 Dauphin, 108
 De Jong, 248
 Delis, 218
 Derera, 89
 Deulvot, 154
 Dharmatti, 90, 188
 Dhillon, 92, 93
 Dicke, 16
 Djian-Caporalino, 180
 Djordjevic, 63
 Dodke, 128
 Doganlar, 108
 Donini, 247
 Dooijeweert, 44, 54, 60
 Dussault, 154, 167
 Dutonde, 84
 Engle, 62
 Fabre, 122
 Fakhfakh, 182
 Falise, 100
 Fazari, 180
 Fekih-Hassen, 182
 Finkers, 193
 Frary, 108
 Fukuoka, 251
 Fuzhong, 91, 129
 Gáborjányi, 186
 Garcés Claver, 121
 Gémes Juhász, 249
 Gharsallah-Chouchene, 182
 Gil Ortega, 121, 134
 Gniffke, 179
 Gocmen, 181
 Gognalons, 154
 González, 121

Gorsane, 182
 Gousset, 183, 184
 Green, 179
 Groenwold, 193
 Gupta, 61, 79, 84
 Gyúró, 95
 Haanstra, 108
 Harn, 220
 Hédont, 161
 Hennart, 108
 Her, 220
 Hirata, 210, 216
 Horváth, 186
 Hosamani, 52
 Hospital, 24
 Hostalery, 122
 Hundal, 92
 Hunje, 86
 Hyung, 220
 Ignatova, 94
 Jacquemond, 139
 Jagadeesha, 86
 Jahn, 100, 246
 Jalali, 171
 Jasmine, 219
 Jawaharlal, 126
 Jullian, 108, 154
 Jung, 220
 Junshao, 91, 129
 Kalpana, 123
 Kanamori, 251
 Kang, 246
 Kapitany, 147
 Kappel, 130
 Karagul, 53
 Karden, 184
 Kaur, 92
 Kazinczi, 186
 Keles, 53
 Khurana, 92
 Kim, 85, 185, 220, 232, 250
 Kochieva, 44, 54
 Kono, 251
 Korzeniewska, 87
 Kovács, 186
 Kreitinger, 100
 Krishna Murthy, 192
 Kumar, 56, 88, 221
 Lanteri, 55, 247
 Le Bot, 122
 Lee, 85, 220, 232, 247
 Lefebvre, 66, 73, 161, 180
 Lesage, 167
 Lester, 108
 Liu, 100
 Luis Arteaga, 134
 Majde, 154
 Marcelis, 101
 Marchoux, 154
 Mariska, 183, 184
 Marrakchi, 182, 217
 Martin, 24
 Matsunaga, 97, 98
 Maxwell, 182
 Mazourek, 100, 246
 Mennella, 178, 196, 203
 Mézard, 24
 Mijatovic, 63, 187
 Mityko, 147
 Mok, 85
 Mongkolporn, 189
 Monma, 98
 Moquet, 154
 Moretti, 154, 167
 Mougou, 131
 Moury, 139, 167
 Nadolska-Orczyk, 218
 Nagy, 89, 147, 224, 227, 249
 Nakhla, 182
 Namiki, 251
 Nandadevi, 90, 188
 Naveen, 192
 Nemouchi, 139
 Nervo, 55
 Niemirowicz-Szczytt, 87, 218
 Nuez, 38
 Nunome, 251
 Obradovic, 187
 Ogata, 216
 Ohyama, 251
 Om, 85
 Oren-Shamir, 248
 Ovadia, 248
 Padmapriya, 124
 Pae, 85, 179
 Pakdevaraporn, 189
 Palloix, 66, 73, 139, 161, 167, 180
 Pandeva, 117
 Paran, 100, 239, 248
 Park, 62, 220

- Patil, 61
 Paulas, 219
 Pédrón, 154
 Pegard, 180
 Petcolicheva, 132
 Phaly, 66, 161
 Pierrugues, 139
 Pijarowski, 180
 Portis, 55, 247
 Prohens, 38
 Quirin, 246
 Rai, 56, 88
 Rajadurai, 126
 Rajamani, 126
 Rao, 57, 221, 239
 Rattan Kumar, 57, 221
 Reddy, 171, 190, 192
 Robaglia, 167
 Rodríguez-Burruezo, 38
 Rotino, 178, 183, 184, 196, 203
 Ruffel, 154, 167
 Ryzhova, 44, 54
 Sabatini, 178
 Sadashiva, 190, 192
 Saito, 97, 98, 191
 Sakata, 98
 Sanap, 61, 79
 Sanjaya, 193
 Sankar, 125, 127
 Sardi, 147
 Sarikyan, 58
 Sasvári, 224, 227
 Sathiyamurthy, 125, 126, 127
 Sato, 98
 Satpute, 128
 Sawant, 79
 Seaves, 183
 Selassié, 154
 Servaes, 184
 Servin, 24, 73
 Sharp, 89
 Shibing, 91, 129
 Shieh, 62, 179
 Shiguchi, 216
 Shiiguchi, 210
 Sidhu, 93
 Signoret, 66, 73, 161
 Sihachakr, 183, 184
 Singh, 56, 88, 92, 93, 192
 Slezak, 130
 Smitha, 171
 Souche, 139
 Stágel, 224, 227, 249
 Stavěliková, 59
 Stewart, 100
 Subramanian, 124
 Sunseri, 178, 196
 Suwabe, 251
 Swart, 101
 Szarka, 147
 Tacconi, 203
 Takács, 186
 Tamietti, 178
 Taranto, 100
 Tarchoun, 131
 Taylor, 189
 Terbe, 130
 Thabuis, 66, 73
 Thakur, 93
 Thamburaj, 219
 Timin, 94
 Timina, 94
 Tishyarakshita, 128
 Tompos, 95
 Toppino, 203
 Tóth, 130
 Tsanev, 132
 Ukkund, 52
 Valentino, 178
 Veeraragavathatham, 125, 126, 127
 Vladova, 132
 Voorrips, 101, 193
 Wang, 96, 252
 Warade, 61, 79, 84
 Wasee, 189
 Weerden, 108
 Wei, 91
 Yamada, 98, 191
 Yang, 220
 Yikang, 91, 129
 Yin, 252
 Yong, 183
 Yongqing, 91, 129
 Yoo, 232
 Yoon, 85
 Yoshida, 97, 98, 191
 Yunju, 129
 Zamfírova, 132
 Zamir, 239
 Zatykó, 249

Zecevic, 63, 187
Zhangyong, 91, 129

Zhung, 210
Ziger, 239

LIST OF PARTICIPANTS

Armenia

SARIKYAN, K.
Center of Vegetable and Industrial
Crop - Darakert, Ararat Region, Masis
Subregion
378322 Masis - Armenia
karuine_sarikyan@mail.ru
Tel: +7 37403640892

Australia

NAGY, N.N.
The University of Sydney - Plant
Breeding Institute
107 Cobbitty Road
2570 Cobbitty Nsw - Australia
natalia@camden.usyd.edu.au
Tel: +61 293518858 - Fax: +61 293513875

Czech Republic

STAVELIKOVÁ, Helena
Research Institute of Crop Production
Slechtitelu 11
78371 Olomouc -Holic - Czech
Republic
stavelikova@genobanka.cz
Tel: +42 585209965 - Fax: +42 585209969

France

AYME, Valérie
INRA - GAFL
P.O. Box 94
84143 Montfavet Cédex - France
valerie.ayme@avignon.inra.fr
Tel: +33 432222744 - Fax: +33 432222702

DAUNAY, Marie-Christine
INRA - Unit of Genetics & Breeding
PO Box 94
84143 Montfouet Cedex - France
daunay@avignon.inra.fr
Tel: +33 432722724 - Fax: +33 432722702

DENET, Frédéric
Clause Tezier SA
26000 Valence - France
frederic.denet@clausetezier.com
Tel: +33 475825338

DJIAN-CAPORALINO, Carolina
INRA - IPMSV department
P.O. Box 2078
6606 Antibes Cedex - France
caporali@antibes.inra.fr
Tel: +33 493678942 - Fax: +33 493678955

HENNART, J.W.
Vilmorin
Centre de la costiere
30210 Ledenon - France
jw.hennart@vilmorin.com
Tel: +33 466573914 - Fax: +33 466573901

HOSPITAL, Frederic
INRA - UMR Génétique Végétal
Ferme Du Moulon
91190 Gif Sur Yvette - France
Frederic.Hospital@moulon.inra.fr
Fax: +33 169332340

LEFEBVRE, Véronique
INRA - GAFL
P.O. Box 94
84143 Montfavet Cédex - France
veronique.lefebvre@avignon.inra.fr
Tel: +33 432222806 - Fax: +33 432222702

LEGRANI, Robert
Takii France
Petit Chemin de la Crau
13630 Eyragues - France
r.legnani@takii.fr
Tel: +33 490928186 - Fax: +33 490928185

MAJDE, Mansour
Gautier Semences
P.O. Box 1
13630 Eyragues - France
Tel: +33 490240270 - Fax: +33 490240271

MISOLLA, Olivier M. de
 SAKATA SEED
 Domaine de Sablas, rue des Moulin
 30620 Uchaud - France
 Tel: +33 466717500

MOQUET, Frederic
 Gautier Semences
 P.O. Box 1
 13630 Eyragues - France
 Tel: +33 490240270 - Fax: +33 490240271

PALLOIX, Alain
 INRA - GAFL
 P.O. Box 94
 84143 Montfavet Cédex - France
 alain.palloix@avignon.inra.fr
 Tel: +33 432222741 - Fax: +33 432222702

POGGI, Patricia
 SEMINIS - Biotechnology department
 Mas de Rouzel, Chemin des Canaux
 30900 Nimes - France
 patricia.poggi@seminis.com
 Tel: +33 466387972 - Fax: +33 466387981

TANAKA, Kazulyuki
 Takii France
 Petit Chemin de la Crau
 13630 Eyragues - France
 kazztanaka@takii.fr
 Tel: +33 490928186 - Fax: +33 490928185

Hungary

NAGY, István
 Agricultural Biotechnology Center
 Szent-Györgyi Albert u. 4.
 H-2100 Gödöllő - Hungary
 inagy@abc.hu
 Tel: +36 28526100 - Fax: +36 28526145

SASVARI, Zsuzsanna
 Agricultural Biotechnology Center
 Szent-Györgyi Albert u. 4.
 H-2100 Gödöllő - Hungary
 sasvari@abc.hu
 Tel: +36 28526100 - Fax: +36 28526145

India

PANDE, Makarand K.
 Ankur Seeds PVT. LTD.
 27, New Cotton Market Layout
 440018 M.S Nagpur - India
 makarand-ngp@sancharnet.in
 Tel: +91 7122729030 - Fax: +91 7122723455

RAJPUT, Jaysing C.
 Nirmal Seeds LTD.
 P.O. Box 63 at Pachora dis. jalgaon
 (ms)
 424201 Pachora - India
 jcr Rajput@rediffmail.com
 Tel: +91 2596244296 - Fax: +91 2596244045

THAKARE, Bhaskar
 Ankur Seeds PVT. LTD.
 27, New Cotton Market Layout
 MS 440018 Nagur - India
 Tel: +91 712-2729030 - Fax: +91 712-2723455

TRIPATHI, Brajesh Kumar
 Nunhems Seeds Private Ltd.
 16 Sri Ramanjaneya Complex, 1st
 A'main, Canara Bank, Newtown
 560064 Yelabanka, Bangalore - India
 b.tripathi@nunhems.com
 Tel: +91 808563894 - Fax: +91 808461972

VEERATHU, R.K.
 Andura University - Botany
 department
 Visakhapatnam
 530003 Visakhapatnam - India
 rattanvk@yahoo.co.in
 Tel: +91 2755547 - Fax: +91 2755547

VISHWAKARMA, Manju
 Ankur Seeds PVT. LTD.
 27, New Cotton Market Layout
 440018 M.S Nagpur - India
 mvishwakarma@hotmail.com
 Tel: +91 7122729030 - Fax: +91 7122723455

WARADE, Sudhakar D.
 Mahatma Phule Krishi Vidyapeeth -
 Agriculture University
 C/21 Mithila Colony, MPKV
 413722 Distt. Ahmednagar - India
 sudhakarwarade@yahoo.co.in
 Tel: +91 2426243446 - Fax: +91 2426243223

Israel

BOROVSKY, Yelena
 Agricultural Research Organization -
 The Volcani Institute
 P.O. Box 6
 50250 Bet-Dagon - Israel
 borovsky@volcani.agri.gov.il
 Tel: +972 39683464 - Fax: +972 39669642

PARAN, Ilan
 Agricultural Research Organisation -
 The Volcani Institute
 P.O. Box 6
 50250 Bet-Dagan - Israel
 iparan@volcani.agri.gov.il
 Tel: +972 39683943 - Fax: +972 39669642

Italy

CSILLERY, Gabor
 ESASEM SPA
 Via G. Marconi 56
 I-37052 Casaleone - Italy
 info@esasem.com
 Tel: +39 0442331600 - Fax: +39 0442330834

FOLTRAN, Giorgio
 Vilmorin Italia Srl.
 Via dei Notai 123 - Blocco 22
 40050 Funo (Bo) - Italy
 giorgio.foltran@vilmorin.com
 Tel: +39 51-863313 - Fax: +39 51-861463

Japan

FUKUOKA, Hiroyuki
 NIVTS
 360 Kusawa, Ano
 514-2392 Mie - Japan
 fukuoka@affrc.go.jp
 Tel: +81 592684651 - Fax: +81 592681339

HIRATA, H.Y.
 Lab. of Plant Genetics and
 Biotechnology - Tokyo University of
 Agriculture
 3-5-8 Saimai-cho, Fuchu
 183-8509 Fuchu, Tokyo - Japan
 yhirato@cc.tuat.ac.jp
 Tel: +81 423675625 - Fax: +81 423675625

NUNOME, Tsukasa
 NIVTS
 360 Kusawa, Ano
 514-2392 Mie - Japan
 nunome@affrc.go.jp
 Tel: +81 592684651 - Fax: +81 592684651

SAITO, Atsushi
 NIVTS
 360 Kusawa, Ano
 514-2392 Mie - Japan
 ashin@affrc.go.jp
 Tel: +81 592684653 - Fax: +81 592681339

SAITO, Takeo
 NIVTS
 360 Kusawa, Ano
 514-2392 Mie - Japan
 romario@affrc.go.jp
 Tel: +81 592684653 - Fax: +81 592681339

TAKIZAWA, Kimiko
 Japan Horticultural Production and
 Research Institute
 2-5-1 Kamishiki Matsudo-shi
 270-2221 Chiba - Japan
 takizawa@enken.or.jp
 Tel: +81 473873827 - Fax: +81 473861455

YAMADA, Tomohiro
 NIVTS
 360 Kusawa, Ano
 514-2392 Mie - Japan
 yamatomo@affrc.go.jp
 Tel: +81 592684653 - Fax: +81 592681339

Philippines**PANERGAYO, Katherine S.**

East West Seed Company
 KM 54 Cagayan Valley Road,
 Sampaloc, San Rafael
 3008 Bulacan - Philippines
 kathchie@eastwestseed.com
 Tel: +63 44-9011370 - Fax: +63 44-9011250

Poland**DELIS, M.**

Warsaw Agriculture University -
 Department of Plant Genetics
 Breeding and Biotechnology
 02-787 Warsaw - Poland
 delis@alpha.sggw.waw.pl
 Tel: +48 228430982 - Fax: +48 228430982

KORZENIEWSKA, Aleksandra

Warsaw Agriculture University -
 Department of Plant Genetics
 Genetics, Breeding and Biotechnology
 02-787 Warsaw - Poland
 niemirowicz@alpha.sggw.waw.pl
 Tel: +48 228430982 - Fax: +48 228430982

**NIEMIROWICZ-SZCZYTT,
Katarzyna**

Warsaw Agriculture University -
 Department of Plant Genetics
 Breeding and Biotechnology
 02-787 Warsaw - Poland
 niemirowicz@alpha.sggw.waw.pl
 Tel: +48 228430982 - Fax: +48 228430982

Senegal**NONO-WOMDIM, Rémi S.**

TECHNISEM-TROPICASEM
 Boulevard du Centenaire, P.O.Box 999
 Dakar - Senegal
 womdim@technisem.com
 Tel: +221 8368656 - Fax: +221 8368658

South-Korea**HARN, Chee**

Nong Woo Bio Co.
 537-17, Jeongdan, Ganam, Yeosu
 469-885 Kyonggi - South-Korea
 chharn@nogwoobio.co.kr
 Tel: +82 318841065

KIM, Byung-Dong

Center for Plant Molecular Genetics
 and Breeding Research
 200-1041 Seoul National University
 151-742 Seoul - South-Korea
 kimbd@edu.ac.kr
 Tel: +82 28804933 - Fax: +82 28735410

KIM, Byung-Soo

Kyungpook National University -
 Department of Horticulture
 1370 Sangyok-dong Bukgu
 702-701 Daegu - South-Korea
 bskim@knu.ac.kr
 Tel: +82 539505729 - Fax: +82 539505722

KIM, D.H.

Center for Plant Molecular Genetics
 and Breeding Research
 200-1041 Seoul National University
 151-742 Seoul - South-Korea
 kdhinchrist@hanmail.net
 Tel: +82 28804933 - Fax: +82 28735410

Spain**ARNEDO ANDRES, Marisol**

Centro de investigacion y tecnologia -
 Agroalimentaria
 Avda. Montañana 930 / Apartado 727
 50080 Zaragoza - Spain
 marnedo@aragob.es
 Tel: +34 976716316 - Fax: +34 976716335

GARCES CLAVER, Ana

Centro de investigacion y tecnologia -
 Agroalimentaria
 Avda. Montañana 930 / Apartado 727
 50080 Zaragoza - Spain
 agarces@aragob.es
 Tel: +34 976716390 - Fax: +34 976716335

LUIS-ARTEGA, Marisol
 Centro de investigacion y tecnologia -
 Agroalimentaria
 Avda. Montañana 930 / Apartado 727
 50080 Zaragoza - Spain
 mpluis@aragob.es
 Tel: +34 976716321 - Fax: +34 976716335

PROHENS, Jaime
 Centro de Conservación y Mejora -
 Universidad Politénia do Valencia
 Camino do Vera 14
 46022 Valencia - Spain
 jpcohens@btc.upv.es
 Tel: +34 963279424 - Fax: +34 963279422

RAMOS-MIRAS, Diego-Jesus
 De Ruiters Seeds Spain
 Doctor Carracio no.9, 3e 5
 4005 Almeria - Spain
 diego.ramos@deruiterseeds.com
 Tel: +34 620-291025

VOTAVA, Eric
 De Ruiters Seeds Spain
 Paraje La Cumbre, s/n El Ejido
 4700 El Ejido - Spain
 eric.votava@deruiterseeds.com
 Tel: +34 477519135

Taiwan

GNIFFKE, Paul A.
 AVRDC - World Vegetable Center
 P.O. Box 42, Shaukua
 741 Tainan - Taiwan
 gniffke@avrdc.org
 Tel: +886 65837801 - Fax: +886 65830009

Thailand

MONGKOLPORN, Orarat
 Kasetsart University - Department of
 Horticulture
 Kamphaengsaen Campus
 73140 Nakhon Pathom - Thailand
 orarat.m@ku.ac.th
 Tel: +66 34281084 - Fax: +66 34281086

WASEE, S.
 Kasetsart University - Tropical
 Vegetable Research Center
 Kamphaengsaen Campus
 73140 Nakhon Pathom - Thailand
 sirikul.w@ku.ac.th
 Tel: +66 34281389 - Fax: +66 34351393

The Netherlands

AARDEN, Harriette C.J.
 Western Seed International B.V.
 Burgemeester Elsenweg 53
 2671 DP Naaldwijk - The Netherlands
 h.aarden@westernseed.nl
 Tel: +31 174-671520 - Fax: +31 174-648199

ALLERSMA, Ton
 De Ruiters Seeds
 P.O. Box 1050
 2660 BB Bergschenhoek - The
 Netherlands
 ton.allersma@deruiterseeds.nl
 Tel: +31 10-5292222 - Fax: +31 10-5292610

BERGEN, Sandra van
 TNO Voeding - Applied plant sciences
 Zernikedreef 9
 2333 CK Leiden - The Netherlands
 van.bergen@voeding.tno.nl
 Tel: +31 71-5181563 - Fax: +31 71-5181933

BOUKEMA, Ietje W.
 CGN
 P.O. Box 16
 6700 AA Wageningen - The
 Netherlands
 ietje.boukema@wur.nl
 Tel: +31 317-477077 - Fax: +31 317-418094

CANADY, Mike
 Nunhems Zaden B.V.
 P.O. Box 4005
 6080 AA Haelen - The Netherlands
 mike.canady@sunseeds.com
 Tel: +31 475-599222 - Fax: +31 475-591361

DEGREEF, Paul C.
 Nunhems Zaden B.V.
 P.O. Box 4005
 6080 AA Haelen - The Netherlands
 p.degreef@nunhems.com
 Tel: +31 475-599222 - Fax: +31 475-591361

DICKE, Marcel
 Wageningen University & Research
 Centre - Laboratorium voor
 Entomologie
 Postbus 8031
 6700 EH Wageningen - The
 Netherlands
 Marcel.Dicke@wur.nl
 Tel: +31 317-484311 - Fax: +31 317-484821

DOOIJEWERT, Willem van
 CGN
 Droevendaalsesteeg 1
 6708 PB Wageningen - The
 Netherlands
 willem.vandooijewert@wur.nl
 Tel: +31 317-477083 - Fax: +31 317-418094

ENGELS, Coert
 Nunhems Zaden B.V.
 P.O. Box 4005
 6080 AA Haelen - The Netherlands
 c.engels@nunhems.com
 Tel: +31 475-599222 - Fax: +31 475-591361

GROOT, Matthijs
 ENZA-Zaden
 Haling 1E
 1602 DB Enkhuizen - The Netherlands
 t.van.der.heiden@enzazaden.nl
 Tel: +31 6-53540098 - Fax: +31 228-315854

HAANSTRA, Jair P.W.
 Rijk Zwaan Breeding B.V.
 P.O. Box 40
 2678 ZG De Lier - The Netherlands
 j.haanstra@rijkszwaan.nl
 Tel: +31 174-532300 - Fax: +31 174-515334

HEGDE, Gopalkrishan
 Nunhems Zaden B.V.
 P.O. Box 4005
 6080 AA Haelen - The Netherlands
 g.hegde@nunhems.com
 Tel: +31 475-599222 - Fax: +31 475-591361

HEIDEN, Tom van der
 ENZA-Zaden
 Haling 1E
 1602 DB Enkhuizen - The Netherlands
 t.van.der.heiden@enzazaden.nl
 Tel: +31 6-53540098 - Fax: +31 228-315854

HORST, T.B. van der
 Bejo Zaden B.V.
 Postbus 50
 1749 ZH Warmenhuizen - The
 Netherlands
 t.vanderhorst@bejo.nl
 Tel: +31 226-396162 - Fax: +31 226-394877

KONING, Herman E.J.
 Syngenta Seeds B.V.
 Blaker 7
 2678 LW De Lier - The Netherlands
 herman.koning@syngenta.com
 Fax: +31 174517487

LEEUWEN, Loes van
 Nunhems Zaden B.V.
 P.O. Box 4005
 6080 AA Haelen - The Netherlands
 loes.vanleeuwen@nunhems.com
 Tel: +31 475-599222 - Fax: +31 475-591361

LEIJ, Jurko J.
 Seminis Vegetable Seeds
 P.O. Box 93
 2675 ZH Honselersdijk - The
 Netherlands
 jurko.leij@seminis.com
 Tel: +31 174-615015 - Fax: +31 174-615020

LINDEMAN, Wouter
 ENZA-Zaden
 Haling 1E
 1602 DB Enkhuizen - The Netherlands
 t.van.der.heiden@enzazaden.nl
 Tel: +31 6-53540098 - Fax: +31 228-315854

MIHÁLKA, Virág
 Seminis Vegetables Seeds
 P.O. Box 22
 1600 AA Enkhuizen - The Netherlands
 virag.mihalka@seminis.com
 Tel: +31 228-357155 - Fax: +31 228-357028

PEETERS, R.A.
 Nunhems Zaden B.V.
 Postbus 4005
 6080 AA Haelen - The Netherlands
 p.geraedts@nunhems.com
 Tel: +31 475-599222 - Fax: +31 475-591361

REKELHOF, Yvonne E.C.M.
 De Ruiters Seeds
 Leeuwenhoekweg 52
 2661 CV Bergschenhoek - The Netherlands
 yvonne.rekelhof@deruitersseeds.com
 Tel: +31 10-5292222 - Fax: +31 10-5292610

SCHRIEK, Marco G.M. van
 Keygene N.V.
 Postbus 216
 6700 AE Wageningen - The Netherlands
 marco.van-schriek@keygene.com
 Tel: +31 317-466866 - Fax: +31 317-424939

SWART, Erik A.M. de
 Plant Research International
 P.O. Box 16
 6700 AA Wageningen - The Netherlands
 erik.deswart@wur.nl
 Tel: +31 317-477285 - Fax: +31 317-418094

VERLAAN, Peter J.W.
 De Ruiters Seeds
 Leeuwenhoekweg 52
 2661 CV Bergschenhoek - The Netherlands
 peter.verlaan@deruitersseeds.com
 Tel: +31 10-5292222 - Fax: +31 10-5292610

VOORRIPS, Roeland E.
 Plant Research International
 P.O. Box 16
 6700 AA Wageningen - The Netherlands
 roeland.voorrips@wur.nl
 Tel: +31 317-477289 - Fax: +31 317-418094

VREUGDENHIL, Dick
 De Ruiters Seeds
 Leeuwenhoekweg 52
 2661 CV Bergschenhoek - The Netherlands
 dick.vreugdenhil@deruitersseeds.com
 Tel: +31 10-5292605 - Fax: +31 10-5292610

WAL, Marion M. van de
 Nunhems Zaden B.V.
 P.O. Box 4005
 6080 AA Haelen - The Netherlands
 m.vandewal@nunhems.com
 Tel: +31 475-599222 - Fax: +31 475-591361

Tunisia

AROUS, S.
 Faculté des Science de Tunis
 Laboratoire de génétique moléculaire
 1060 Tunis - Tunisia
 aroussa@voila.fr
 Tel: +216 1506912 - Fax: +216 1485480

United States of America

BEN-CHAIM, Arnon
 Cornell University
 310 Bradfield Hall
 NY 14853 Ithaca - USA
 av357@cornell.edu
 Tel: +1 6072559187 - Fax: +1 6072556683

BERKE, Terry
 Seminis Veg. Seeds
 37437 State NWY 16
 95695 Woodland - USA
 terry.berke@seminis.com
 Tel: +1 5306696119 - Fax: +1 5306666791

BOSLAND, Paul W.

New Mexico State University
 P.O. Box 30003 MSC 3Q
 88003 Las Cruces, Nm - USA
 pbosland@nmsu.edu
 Tel: +1 5056465171 - Fax: +1 5056466041

JIANG, Chunxiao

Syngenta Seeds
 10290 Greenway Road, Naples
 34-114 Florida - USA
 chunxiao.jiang@syngenta.com
 Tel: +1 2397754090 - Fax: +1 2397746852

KANG, B.C.

Cornell University - Department of
 Plant Breeding
 320 Bradfield Hall
 NY 14853 Ithaca - USA
 bk54@cornell.edu
 Tel: +1 6072552574 - Fax: +1 6072556683

RILEY, Mary K.

Sakata Seed America Inc.
 P.O. Box 1118
 FL 33970 Lehigh Acres - USA
 mriley@sakata.com
 Tel: +1 2393690032 - Fax: +1 2393697538

SUBRAMANYA, Subu

Pepper Research Inc.
 P.O. Box 1068
 33470-1068 Loxahatchee, Florida -
 USA
 subupepre@aol.com
 Tel: +1 5617530057 - Fax: +1 5617536705

Yugoslavia**MIJATOVIC, M.**

Centre for vegetable crops
 Karadjordjeva 71
 11420 Smederevska Palanka -
 Yugoslavia
 info@cvcsp.co.yu
 Tel: +381 26323170 - Fax: +381 26323785

ZECEVIC, Bogoljub

Centre for vegetable crops
 Karadjordjeva 71
 11420 Smederevska Palanka -
 Yugoslavia
 bzecevic@cvcsp.co.yu
 Tel: +381 26323170 - Fax: +381 26323785