



# Design and Simulation of CFOA Based Higher Order Low Pass Filter

Vijay Laxmi Kalyani, Asmi Sadaf  
Vijay Laxmi Kalyani, Assistant Professor, GWCEA  
vijaylaxmikalyani@yahoo.com  
Asmi Sadaf, B.Tech, EEE, GWCEA  
sadafasmi0@gmail.com

**Abstract:** High order Filters are used for many applications. These types of filters provide higher attenuation at frequencies beyond the break frequencies. Current feedback operational amplifiers prove to be practically well suited for designing the filters for high frequency applications. In this paper the author proposed the design of second-order low-pass Butterworth filter for higher frequency application based on CFOA (Current feedback operational amplifier) using AD844 IC. The experimental results done using NI-Multisim software, ultiboard results and 3D view of the circuit are also shown in this paper.

**KEYWORDS:** Low pass filter, CFOA, AD844, Higher order filters

## I. INTRODUCTION

A filter is a device or process that removes some unwanted components or features from a signal. Filters are widely used in electronics and telecommunication, in radio, television, audio recording, radar, control system, music synthesis, image processing, and computer graphics. The higher order active filters are specially designed for analog circuitry . These provide sharper transition , and provide flatter pass-band , stop-band with increasing degrees, leading to either better amplitude preservation, or attenuation. Many types of filters were designed in the literature [1]-[3]. In [1] High order low-pass and high pass filters were designed in both active and passive cases. In [2] a new current mode circuit realized simultaneously with low-pass, high-pass and band-pass filter. In [3] forth order band-pass active filter were designed using a "lossy" low-pass to band-pass transformation.

In this paper a second higher order low pass filter is designed for high frequency application. The proposed circuit is designed using current feedback operational amplifier (CFOA). CFOA realizes variable gain and constant bandwidth. The slew rate in CFOAs is much higher from several hundred to several thousand V/ $\mu$ s. CFOA based circuits are capable of operating over a very higher frequency ranges. Therefore, in this paper the second higher order low pass filter circuit is designed at higher frequency range at 1GHz using AD844 IC. It is the CFOA based IC. AD844 IC has very high slew rate approx. 2000 V/ $\mu$ s. It has a larger bandwidth around 60 MHz at gain of -1 and around 33MHz at gain of -10 [4].

## II. SECOND HIGHER ORDER LOW PASS FILTER

An active low pass filter passes signals with a frequency lower than a certain cut-off frequency and attenuates signals with frequencies higher than the cut-off frequency. The exact frequency response of the filter depends on the filter design. The filter is sometimes called a high cut filter, or treble-cut filter in audio applications. A low pass filter is the complement of high pass filter. low pass filter exists in many forms such as a hiss filter used in audio, anti aliasing filters for conditioning signals prior to analog-to-digital conversion, digital filters for smoothing sets of data , acoustic barriers, blurring of images etc.

The main advantage of designing the low pass filter using higher order is that it increases the roll-off in form of 20 dB/decade. The second higher order low pass- filter can provide -40 dB/decade roll-off rate in the stop band. The order of the filter increases with the help of number of resistor and capacitor combination in the circuitry. In these filters the stop band response having a roll-off (40 db per decade) is obtained with the help of combining additional R-C network in the circuitry.

## III. DESIGN OF CFOA BASED SECOND ORDER LOW-PASS FILTER USING AD844 IC

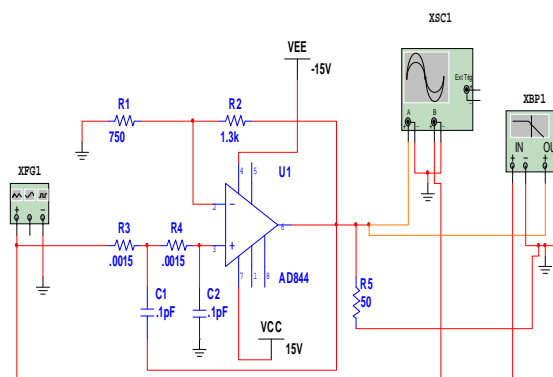

Fig.1: second order low-pass filter using AD844 IC



#### IV. CALCULATIONS

To calculate the value of resistor  $R$ , the value of cut-off frequency and capacitor is required,

$$F_c = 1\text{GHz} \quad , \quad C = 0.1\text{pF} \quad (\text{where } C_1=C_2=C) \quad R_1 = 750 \quad , \quad R_2 = 1.3\text{K}$$

$$F_c = \text{---}$$

$$R = \text{---}$$

$$R = .0015 \quad (\text{where } R_3=R_4 = R)$$

The circuit is based on butterworth filter design. The butterworth filter designs widely used due to its simplicity and it also provide flat pass band and flat stop band response.

#### V. SIMULATION RESULTS

After the designing the circuit the simulation result is shown on frequency at 1GHz, the output is obtained as follows:

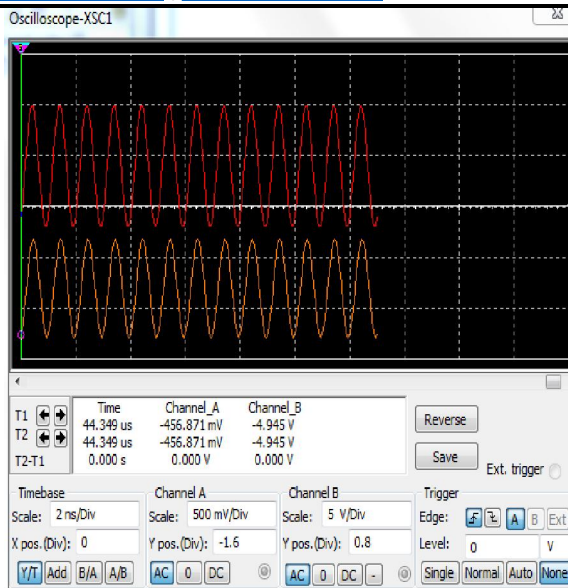

Fig.3: sinusoidal output waveform at 1GHz

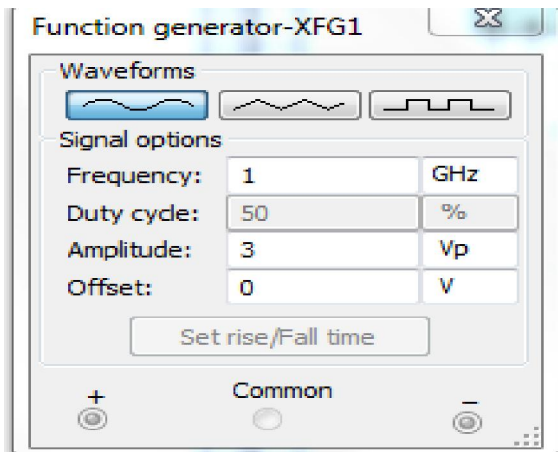

Fig.2: input frequency at 1GHz using function generator

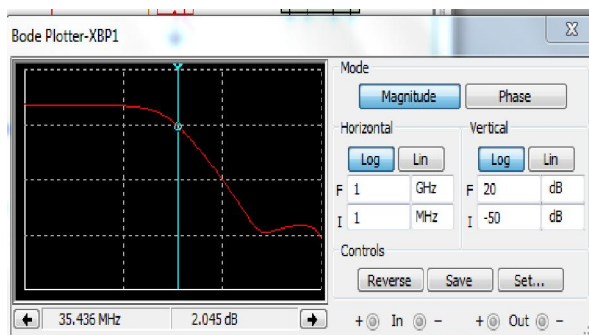

Fig.4: frequency response curve using bode plotter result

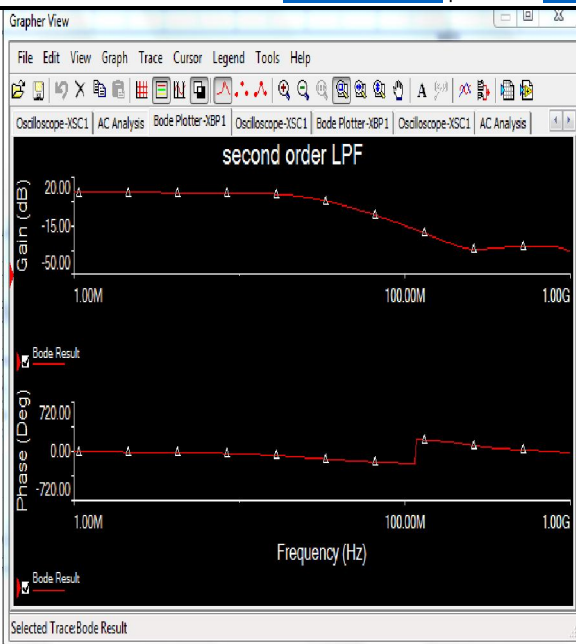

Fig.5: phase and magnitude response using grapher view

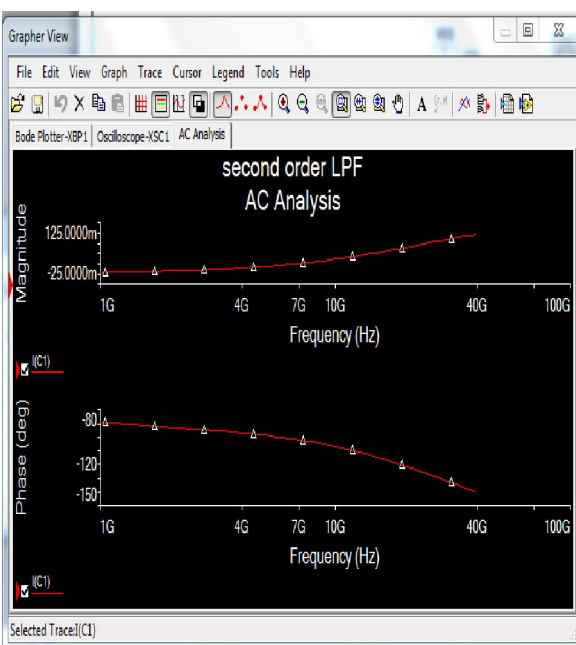

Fig.6: AC Analysis of Low Pass Filter using grapher view

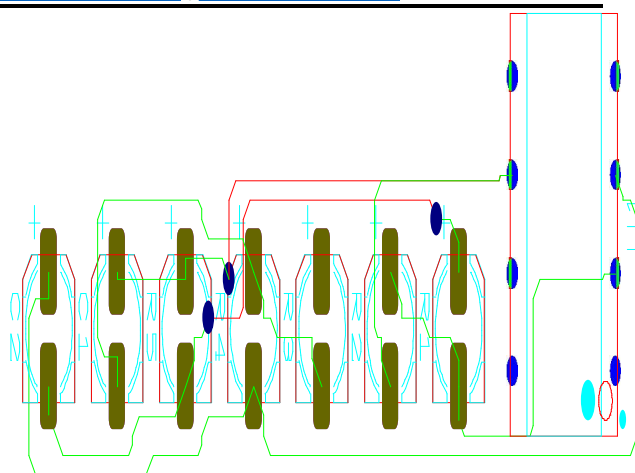

Fig.7: ultiboard layout

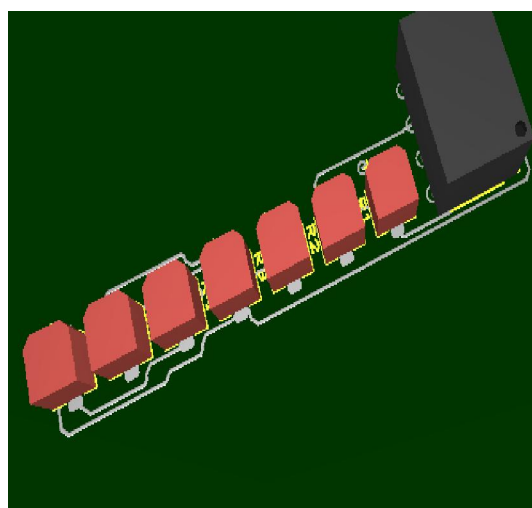

Fig.8: 3 D view of the circuit

## V. CONCLUSION

In this paper we concluded that the higher order filter can be designed for higher frequency applications using CFOA. We concluded that increasing the order of the filter it allows more flexibility in the circuitry. The proposed circuit is designed at 1GHz frequency. The results shows that at 1GHz frequency range the output is obtained and bode plotter show that the pass band frequency range is 35.436 MHz with 2.045 dB and the roll-off increases upto -50 db/decade. It shows that the sharpness of transition region between flatter pass band and attenuate frequencies. The AC analysis of phase and magnitude are also determined. We concluded that design of CFOA based



second order low-pass filter using AD844 IC is used for higher frequency applications.

#### REFERENCES

- [1] M.D.N.H.Khan et.al, “Importance of high order high pass and low-pass filter”, world applied science journal 34(9):1261-1268,2016,ISSN:1818-4952
- [2] Nisha Walde, Sayeed Naseem Ahmed, “New current mode second order filter using current feedback amplifiers (CFAS)” International Journal of Computer Applications (0975-8887) ,Vol 86 – No 16, January 2014
- [3] Drazen Jurisic et.al, “Design of Fourth Order Band Pass Active R-C Filter using a “lossy” Low- pass to Band-pass Transformation”, ECCTD’01- European Conference on circuit theory and Design, August 28-31, 2001, Espoo, Finland
- [4] Raj Senani and D. R. Bhaskar, “Current Feedback Operational Amplifiers and Their Applications (Analog Circuits and Signal Processing)” Springer book

#### Author’s Details

**Vijay Laxmi Kalyani:** assistant professor and former HOD from ECE department , Govt. Women Engg. College, AJMER.

**Asmi Sadaf :** B.Tech student (Pursuing),EEE Branch, Govt. Women Engg. College, AJMER