



Calcium dependent current recordings in *Xenopus laevis* oocytes in microgravity



Simon L. Wuest, Christian Roesch, Fabian Ille, Marcel Egli*

Lucerne University of Applied Sciences and Arts, School of Engineering and Architecture, Institute of Medical Engineering, Space Biology Group, Hergiswil, Switzerland

ARTICLE INFO

Keywords:

Electrophysiology
Xenopus laevis oocyte
 Calcium-dependent current
 Microgravity
 Parabolic flight

ABSTRACT

Mechanical unloading by microgravity (or weightlessness) conditions triggers profound adaptation processes at the cellular and organ levels. Among other mechanisms, mechanosensitive ion channels are thought to play a key role in allowing cells to transduce mechanical forces. Previous experiments performed under microgravity have shown that gravity affects the gating properties of ion channels. Here, a method is described to record a calcium-dependent current in native *Xenopus laevis* oocytes under microgravity conditions during a parabolic flight. A 3-voltage-step protocol was applied to provoke a calcium-dependent current. This current increased with extracellular calcium concentration and could be reduced by applying extracellular gadolinium. The custom-made “OoClamp” hardware was validated by comparing the results of the 3-voltage-step protocol to results obtained with a well-established two-electrode voltage clamp (TEVC). In the context of the 2nd Swiss Parabolic Flight Campaign, we tested the OoClamp and the method. The setup and experiment protocol worked well in parabolic flight. A tendency that the calcium-dependent current was smaller under microgravity than under 1 g condition could be observed. However, a conclusive statement was not possible due to the small size of the data base that could be gathered.

1. Introduction

Living organisms respond strongly to daily mechanical load. Higher organisms as diverse as plants and animals are able to adapt to changing mechanical-loading conditions. Yet, despite rapid developments in cellular and molecular biology, very little is known about the molecular mechanisms used by cells to transduce mechanical forces (mechanotransduction) [1]. Among other mechanisms, mechanosensitive ion channels (MSCs) (also referred as stretch activated channels) are thought to play a key role [2]. For many MSCs, it is unclear how the mechanical force is forwarded to the channel. While some specific channels are thought to be linked either directly or indirectly to the cytoskeleton or the extracellular matrix, others are believed to interact only with the surrounding lipids [1,3–5]. For the latter channels, the gating mechanism could be affected by membrane properties and lipid mismatches [1,4,5]. Surprisingly, plain lipid membranes and membranes of the human neuroblastoma cell line SH-SY5Y become more fluid (lower viscosity) as gravity decreases during parabolic flights [6]. Microgravity (or weightlessness) is known to trigger multiple adaptation processes at the organ level [7]. Even isolated cells respond to reduced gravity, as observed in

various space-flown cell-culture experiments [8]. This came as a surprise because gravity becomes a very small force at the cellular or even molecular level, and cells are thought to be unable to detect gravity [9].

Since the properties of lipid membranes depend (among other parameters) on gravity, one could expect that gravity would influence specific ion channels as well. Indeed, the open state probability of porins isolated from *Escherichia coli* and incorporated into planar lipid bilayers decreased under microgravity and increased under hypergravity [10]. Alamethicin, an artificial pore-forming polypeptide, shows reduced activity under micro- and hypergravity [10–12]. Furthermore, native oocytes from *Xenopus laevis* as well oocytes that overexpress epithelial sodium channels (ENaCs) demonstrated reduced membrane conductivity under microgravity and increased conductivity under hypergravity (in parabolic flights) [13,14]. Ion channels are the key mediators of action potentials (APs) in excitable cells. The AP propagation velocity appeared to decrease under microgravity conditions and increase under hypergravity conditions in intact earthworms and isolated axons of rats and earthworms [15]. The frequency of spontaneous spiking in leech neurons increased in microgravity during a drop tower experiment [15]. In agreement with these results, spreading depression (SD) waves in

* Corresponding author. Lucerne University of Applied Sciences and Arts, School of Engineering and Architecture, Institute of Medical Engineering, Seestrasse 41, CH-6052, Hergiswil, Switzerland.

E-mail address: marcel.egli@hslu.ch (M. Egli).

<https://doi.org/10.1016/j.actaastro.2017.10.003>

Received 3 August 2017; Received in revised form 7 September 2017; Accepted 2 October 2017

Available online 3 October 2017

0094-5765/© 2017 The Authors. Published by Elsevier Ltd on behalf of IAA. This is an open access article under the CC BY license (<http://creativecommons.org/licenses/by/4.0/>).

neuronal tissue were slower under microgravity and faster under hypergravity (in parabolic flights and centrifuges) [16–19]. SD waves are depolarization waves, which are followed by a refractory period. However, the SD waves were faster during a sounding rocket mission (TEXUS). The authors speculated that a possible adaptation effect from the launch could have caused this disagreement [16].

Calcium (Ca^{2+}) is a ubiquitous intracellular signal responsible for controlling numerous cellular processes, including the cell cycle, proliferation, differentiation, apoptosis and cytoskeletal remodeling [2,20]. Since several ion channels have been shown to be sensitive to mechanical load, mechanical load could very well interfere with Ca^{2+} signaling [2]. The intracellular concentration of free Ca^{2+} under various gravitational loads has been investigated in several studies with controversial results. The intracellular Ca^{2+} concentration of neuronal cells decreased under microgravity during a drop tower experiment [21]. Conversely, in a human neuroblastoma cell line (SH-SY5Y) the intracellular Ca^{2+} concentration increased under hyper- and microgravity during a parabolic flight, which was then believed to be due to a memory or hysteresis effect resulting from increased Ca^{2+} concentration during the hypergravity phase [22]. Recent data from the same cell line (SH-SY5Y, undifferentiated state) showed that the intracellular Ca^{2+} concentration increased under lower gravity and decreased under higher gravity (parabolic flight) [23]. The gravitactic unicellular algae *Euglena gracilis* showed a transient increase in its intracellular Ca^{2+} when going from lower to higher accelerations during parabolic flights [24]. The unicellular algae *Astasia* showed an increase in its Ca^{2+} signal upon acceleration and a decrease in microgravity conditions during a sounding rocket experiment (MAXUS 3) and a parabolic flight [24,25]. *Arabidopsis thaliana* cells showed an increase in intracellular Ca^{2+} concentration under low gravity and a decrease under hypergravity (parabolic flight) [26].

Here, we describe a method to record a Ca^{2+} -dependent current in native *Xenopus laevis* oocytes under microgravity conditions during a parabolic flight. Several Ca^{2+} -permeable ion channels have been described in native *Xenopus laevis* oocytes. They can be roughly divided into voltage-dependent or Ca^{2+} -store-operated channels [27,28], whereas the store-operated channels are expected to play a minor role in the experiment described here. Ca^{2+} also regulates multiple Ca^{2+} -dependent ion channels in the oocytes membrane. Cl^- , K^+ , Na^+ and non-selective cation channels have been described to be Ca^{2+} -dependent [27,28].

2. Materials and Methods

2.1. Hardware

Two hardware setups were used in this study: the (standard) two-

electrode voltage clamp (TEVC) [29] and the custom-made “OoClamp,” which was designed specifically for electrophysiological recordings during parabolic flights.

In the TEVC setup, a single *Xenopus laevis* oocyte was impaled with two glass micro-pipettes, allowing for low-impedance access to the cytosol. The pipettes were filled with 3 M KCl solutions and an Ag-AgCl pellet electrode interfaced to the voltage clamp electronics, which allowed for the measurement and control of the cytosolic potential (relative to the extracellular medium) via a negative feedback loop (Fig. 1). Two additional bath electrodes held the extracellular medium at the ground potential and allowed the transmembrane current to be measured using a transimpedance amplifier configuration. After the oocyte was impaled, it was continuously perfused with a physiological solutions. The perfusion was gravity driven. Solenoid valves allowed for rapid solution changes in the recording chamber.

The custom-made “OoClamp” has been described previously [14] and can be thought of as an adapted patch-clamp technique. The voltage-dependent transmembrane currents of native oocytes were measured in individual recording chambers, each holding one oocyte. A patch of the cell’s membrane was electrically isolated by pressing the oocyte against an aperture (Fig. 1). The recording chamber was divided into two compartments, separated by the membrane patch. Both compartments were filled with 100Na solution (containing 100 mM NaCl, 1.8 mM CaCl_2 , 1 mM MgCl_2 , 2 mM KCl and pH-buffer, see below). They were each equipped with two Ag-AgCl pellet electrodes that allowed for the simultaneous application of a defined voltage across the cell patch and measurement of the corresponding voltage-dependent current. The lower compartment was formed as a channel and allowed the exchange of medium in contact with the cell patch. The media exchange was driven by air pressure (Fig. 2). The medium containers were pressurized with a pressure controller, such that the medium was pressed out through capillaries and into the recording chambers. The capillaries (40 cm long and an inner diameter of 0.18 mm) determined the hydrodynamic resistance and defined the flow rate together with the perfusion pressure. Valves before the recording chamber allowed the medium flow to be controlled. The used medium was collected in a waste bag. The OoClamp accommodated containers and valves for up to three different media. Gentle pressure was applied to the upper compartment to prevent the oocytes from being displaced and to ensure good electrical isolation of the membrane patch from the remaining cell’s membrane (seal). The voltage and current signals were generated, measured and digitized in close proximity to the recording chambers. The OoClamp was controlled via USB with an external laptop. Three OoClamp units were mounted in an aluminum box, which could be fixed in an aircraft for parabolic flight (see below). Custom-made software (running on the laptop) was used to control all three units in parallel and store the acquired data (Fig. 3).

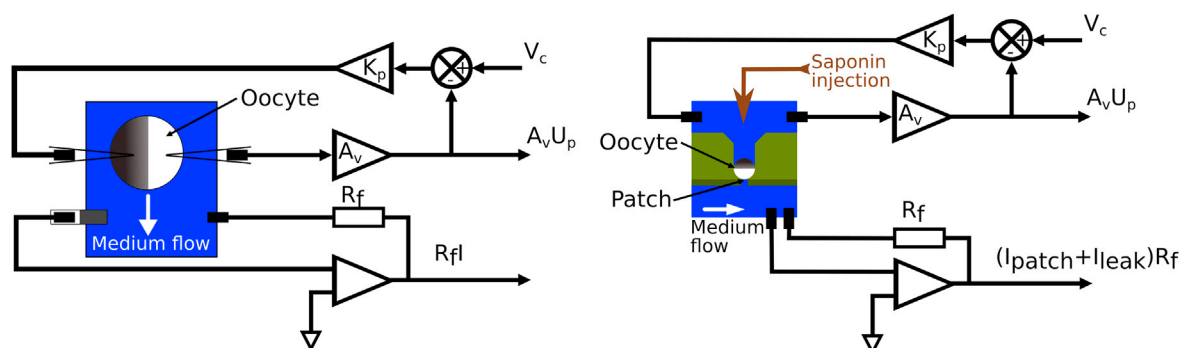

Fig. 1. Schematic of the functional principle of the TEVC and the OoClamp. In the TEVC setup (left), an oocyte from the *Xenopus laevis* was impaled with two glass pipettes, which allows the cytosolic potential to be measured and controlled via a negative feedback loop. Two additional bath electrodes pulled the extracellular medium to the ground potential and allowed the transmembrane current to be measured. In contrast, with the OoClamp (right), the oocyte was held in a cavity of a silicone chip with a tiny hole at the far end. By applying top pressure, the oocyte was pressed against this hole to electrically isolate a patch of the cell’s membrane. The recording chamber was divided into upper and lower compartments by the membrane patch. Both were fitted with two electrodes. Also, using a negative feedback loop, defined voltages were applied across the cell patch and the corresponding voltage-dependent current was measured.

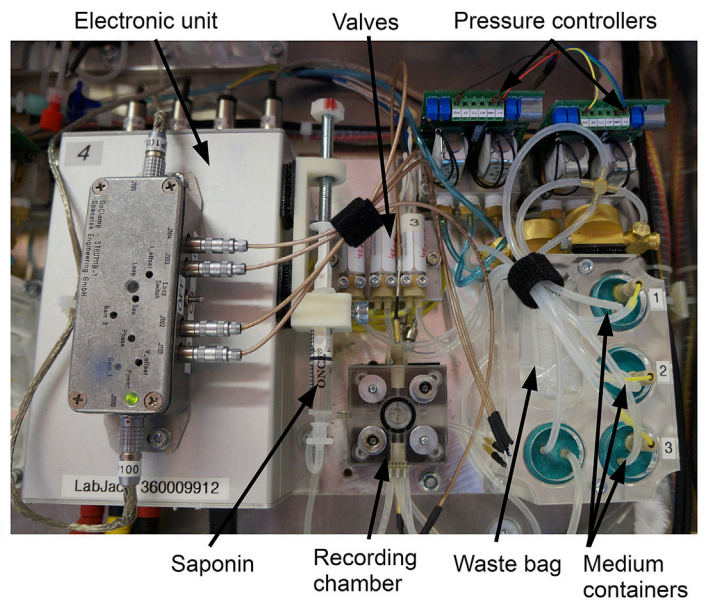
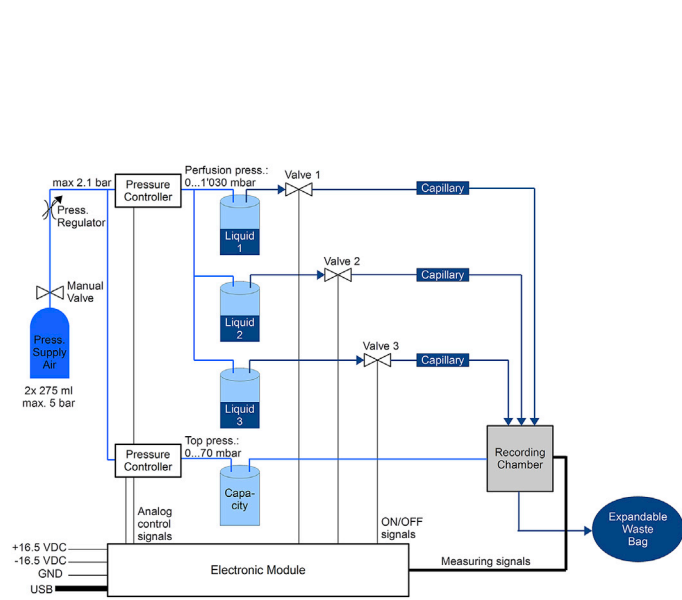

Fig. 2. OoClamp system. Schematic illustration (left) and photograph (right) of the OoClamp system. The media exchange was driven by air pressure. The medium containers were pressurized with a pressure controller, such that the medium was pressed out through capillaries and into the recording chambers. Valves before the recording chamber allowed the medium flow to be controlled. The used medium was collected in a waste bag. Gentle pressure was applied to the upper compartment to ensure good electrical isolation of the membrane patch. The OoClamp was controlled via USB with an external laptop. Saponin solution was injected with 2-ml syringes into the upper compartment of the recording chamber after the oocyte was placed and the top pressure was applied (not shown in the left illustration). Approximately 120 μ l of Saponin was injected by slowly turning a thread.

The OoClamp's recording chamber was modified from those used in previous parabolic flights [14]. The oocyte was held in a cavity of a silicone chip with a 0.3 mm diameter hole at the bottom (Fig. 1). By applying top pressure, the oocyte was pressed against this hole to electrically isolate a patch of the cell's membrane. Because the silicone was too soft to support a 0.3 mm hole reliably, the chip was reinforced with a glass slide, which had a thickness of approximately 0.3 mm. The 0.3 mm hole was drilled into the glass slide before the silicone was cast around it. The fluid in contact with the membrane patch was exchanged using a micro-fluidic chip, which was also cast in silicone (similar to the previous design). The two silicone chips were placed in a polymethyl methacrylate (PMMA) housing, which held the two silicone chips, the electrodes and the tubing for the fluids.

Saponin solution was injected into the upper compartment of the recording chamber to create electrical access to the cytosol (Fig. 1). Saponin selectively removes membrane cholesterol and leaves holes in the membrane with a diameter of approximately 100 Å, which allows

ions to pass [30,31]. Saponin was injected after the oocyte was placed in the recording chamber, ensuring that only the oocyte's upper hemisphere was perforated. Before the experiments, 2-ml syringes were filled with 1% saponin solution. After the top pressure was applied and stable contact was formed between the oocyte and the silicone chip, approximately 120 μ l of saponin was injected into the recording chamber, by slowly turning a thread. This resulted in a final saponin concentration of approximately 0.3%.

2.2. Experiments with the TEVC

The experiments with the well-established TEVC were used to validate the Ca^{2+} -dependent current recordings obtained with the OoClamp. An oocyte was placed in the TEVC and impaled with two glass pipettes. The oocyte was then voltage clamped at -30 mV (holding potential) and continuously perfused with 100Na (see below). A 3-voltage-step protocol, adapted from Courjaret et al. [32], was applied to the oocytes. The

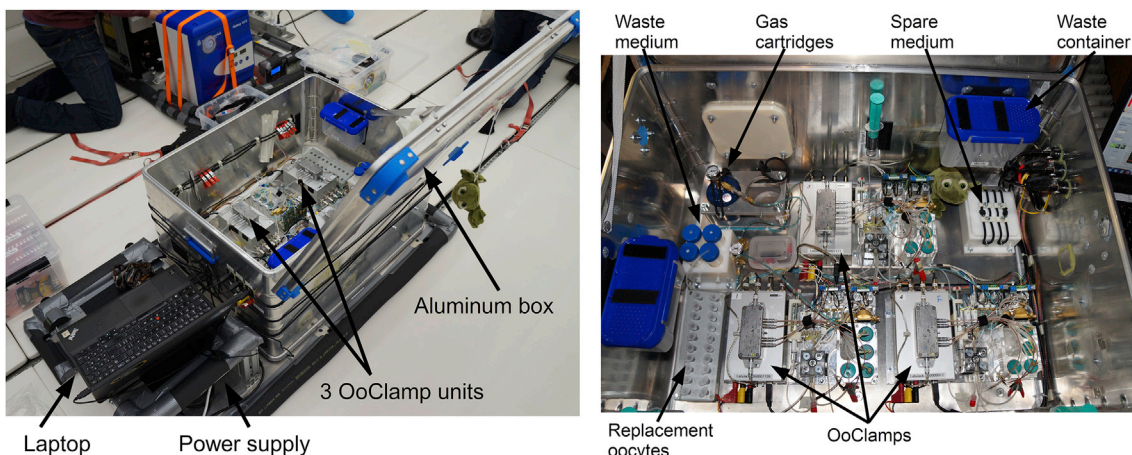

Fig. 3. OoClamp rack. Three OoClamp units, accessory materials, spare parts and medium containers were fixed in a closed aluminum box. The box could be opened under 1 g conditions to access the OoClamps and replace the oocytes. The power supply and laptop were fixed outside of the box. The rack was mounted to the aircraft floor with two aluminum base plates.

resting Ca^{2+} concentration was first recorded using a depolarizing voltage jump from -30 to $+40$ mV. The following hyperpolarization step at -180 mV increased the driving force for Ca^{2+} and allowed Ca^{2+} to flow through open plasma membrane channels, which activated further chloride channels. The third voltage jump was again a depolarization step to $+40$ mV. The difference in the mean current between the two depolarization steps was an indicator of the Ca^{2+} influx during the hyperpolarization step (Fig. 4). All of the voltage steps were 0.5 s long.

This 3-voltage-step protocol was applied to the same oocytes while they were perfused with 100Na containing various concentrations of Ca^{2+} (0, 2, 5, 10 and 20 mM). The oocytes were left to recover at the holding potential of -30 mV for 1 min between two subsequent recordings. In total, the experiment was repeated on 47 oocytes from three different frogs.

We further tested if the current could be blocked by the nonspecific Ca^{2+} -channel blocker gadolinium (Gd^{3+}) [33–38]. Oocytes were exposed to 100Na containing 2 mM Ca^{2+} , Ca^{2+} -free 100Na and 100Na containing 2 mM Ca^{2+} plus 1 mM Gd^{3+} . As before, the oocytes were left to recover at the holding potential of -30 mV for 1 min between two subsequent recordings. The experiment was repeated on 42 oocytes from three different frogs.

All of the acquired currents were normalized (per oocyte) to the standard perfusion with 100Na containing 2 mM Ca^{2+} . The pooled data were plotted as box plots using Matlab (R2012b).

2.3. Experiments with the OoClamp: on ground and during parabolic flight

The experiments performed on the OoClamp were similar to those performed with the TEVC. The recording chamber was first filled with 100Na, and an oocyte was placed inside the chamber. Then, the chamber was closed, and a nominal top pressure of 30 mbar was applied. The membrane patch was continuously perfused with 100Na using a nominal perfusion pressure of 150 mbar. Subsequently, it was verified that the oocyte made a tight contact with the silicone chip by applying a series of voltage steps. The seal resistances between the oocyte and the silicone chip were typically 100–200 kOhm. Seal resistances below 65 kOhm were excluded from the data analysis. Furthermore, a clear current transient had to be visible when applying a voltage step. Then approximately 120 μl of 1%-saponin solution was slowly injected into the upper compartment. Finally, the oocytes were voltage clamped at -30 mV.

As described above, with the TEVC, the oocytes are impaled with micro-pipettes, which guarantee electrical access to the cytosol, and the membrane of the whole cell contributes to the current signal. For the OoClamp, in contrast, the oocyte does not have to be punctured, which is a major advantage during parabolic flights. However, this advantage comes at the cost of three restrictions. First, the electrical access to the cytosol has to be created with a membrane permeabilizing agent like saponin. This should allow for electrical access without damaging the membrane too much, so that the oocyte remains intact for the period of the experiments. Second, the measurement is done across a small patch with an area approximately 40 times smaller than the surface area of the whole cell. Therefore, the current signal is concomitantly smaller. Third, the seal resistance formed between the oocyte and the silicone chip is at best a few hundred kOhms and much smaller than in regular patch clamping, for instance. Therefore, the 3-voltage-step protocol had to be modified. During the hyperpolarization step, the potential was decreased to -250 mV and the duration was prolonged to 4 s. The two depolarization steps were left the same at $+40$ mV for 0.5 s. As for the TEVC protocol, the difference in mean current between the two depolarization steps was considered to be an indicator of the Ca^{2+} influx during the hyperpolarization step (Fig. 4).

As described in the Results section, the difference in mean current between the two depolarization steps depended on the extracellular Ca^{2+} concentration. We verified whether this finding could be reproduced on the OoClamp. The 3-voltage-step protocol was applied to the same oocytes while their membrane patches were perfused with 100Na containing 0, 2 or 20 mM Ca^{2+} . (Due to the limited space in the aircraft, the OoClamp only allowed up to three different solutions to be tested.) The oocytes were left to recover at the holding potential of -30 mV for 1 min between two subsequent recordings. In total, the experiment was repeated on 66 oocytes from three different frogs. The acquired currents were normalized (per oocyte) to the standard perfusion with 100Na containing 2 mM Ca^{2+} . The pooled data were also plotted as box plots using Matlab (R2012b).

We further tested the protocol introduced above during a parabolic flight (see section Parabolic flight). The 3-voltage-step protocol was applied to the same oocytes under 1 g and microgravity conditions. The membrane patches were perfused with 100Na containing 1.8 mM Ca^{2+} . The oocytes were left to recover at the holding potential of -30 mV for at least 1 min between two subsequent recordings. Due to the long recovery

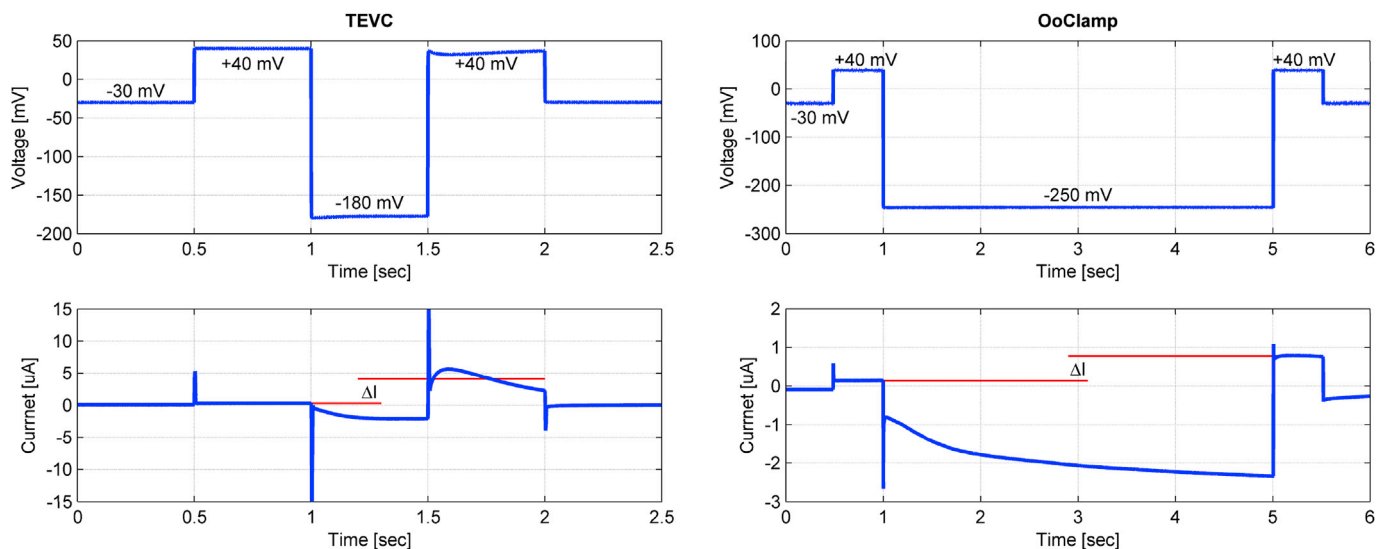

Fig. 4. 3-voltage-step protocol. The first step was a depolarization step to determine the resting Ca^{2+} concentration. The following hyperpolarization step increased the driving force for Ca^{2+} , allowing Ca^{2+} to flow through open plasma membrane channels. The third voltage jump was another depolarization step. The difference in mean current between the two depolarization steps (ΔI) was used as an indicator of the Ca^{2+} influx during the hyperpolarization step. The protocol had to be adapted accordingly because of the differing characteristics of the TEVC (left) and the OoClamp (right).

period, it was impossible to conduct recordings during the hypergravity phases, before and after the microgravity phase. Three oocytes were always recorded in parallel. The oocytes were replaced in flight after four subsequent parabolas.

Before each execution of the 3-voltage-step protocol, the seal resistance was determined by applying a series of voltage steps. The seal resistance was used as a quality check for the contact of the oocyte to the silicone chip. Because lipid bilayers are impermeable to charged particles, they behave like capacitors to voltage steps. Therefore, a short current transient is detectable upon applying a voltage step to an oocyte. This transient indicates the movement of charges to or from the membrane. The current transients obtained from the seal resistance measurements were fitted to the following equation to compute the time constant τ :

$$i_t = i_0 \cdot e^{-t/\tau}$$

where t represents the time, i_0 is the current when t equals zero and i_t is the current at any arbitrary time for t larger than zero.

2.4. Parabolic flight

The parabolic flight was conducted on an Airbus A310 operated by Novespace (Bordeaux, France) as part of the 2nd Swiss Parabolic Flight Campaign. During the parabolic maneuver, the aircraft initially pulled up and climbed using engine thrust. This phase was accompanied by hypergravity of up to 1.8 g for around 20 s. Then, the thrust was reduced and the aircraft's nose was lowered, such that it followed a ballistic trajectory. During this period, lasting approximately 20 s, the aircraft was in a free-fall like state, and microgravity was experienced. Finally, the aircraft pulled out of the ballistic trajectory into horizontal flight. This phase was again accompanied by hypergravity of up to 1.8 g. Four subsequent parabolas were repeated every 3 min. Three blocks of parabolas were flown, interrupted by a longer pause, which allowed for the in-flight exchange of the oocytes. The fourth and last block consisted of three parabolas: one with lunar gravity (0.16 g), one with Martian gravity (0.38 g) and the last with microgravity.

The experimental implementation was designed according to the requirements and guidelines of Novespace. Three OoClamp units, accessory materials, spare parts and medium containers were fixed in a fully closed aluminum box. The bottom of the box was reinforced with an aluminum plate, which allowed the fixation of the hardware and ensured mechanical stability. The box could be opened under 1 g conditions to access the OoClamps and replace the oocytes. A power supply was fixed in an aluminum frame outside of the box. A laptop to control the three OoClamp units was placed on the frame. The aluminum box and frame were both fixed to two aluminum base plates, which permitted the entire structure to be mounted to the aircraft floor (Fig. 3).

2.5. Chemicals and oocytes

Native oocytes were obtained from the University of Zurich (Switzerland) and Ecocyte (Castrop-Rauxel, Germany). Fresh oocytes were prepared by the respective organizations and transported readily to the dedicated facilities for experiments.

The oocytes were kept at 17 °C in modified Barth medium, containing in mM 88 NaCl, 1 KCl, 0.41 CaCl₂, 0.82 MgSO₄, 2.5 NaHCO₃, 2 Ca(NO₃)₂ and 7.5 HEPES-TRIS, adjusted to a pH of 7.5. In the TEVC and the OoClamp, the oocytes were perfused with 100Na, containing in mM 100 NaCl, 1.8 CaCl₂, 1 MgCl₂, 2 KCl and 10 HEPES-TRIS, adjusted to a pH of 7.4. For the Ca²⁺-dependent experiments, 100Na was used, with Ca²⁺ being replaced by 2, 5, 10 and 20 mM Ca²⁺. In the medium containing no Ca²⁺, 1 mM EGTA (Ethylene glycol-bis(2-aminoethyl ether)-N,N,N',N'-tetraacetic acid) was added instead. During the experiments conducted with Gd³⁺, the oocytes were exposed to 100Na that also contained 2 mM Ca²⁺ and 1 mM Gd³⁺. Saponin was dissolved to a 1% solution in 100Na

before the experiments and then filled into 2-ml syringes.

3. Results

As described in the Materials and Methods section, a 3-voltage-step protocol was applied to the oocytes. The difference in mean current between the two depolarization steps was used as an indicator of the Ca²⁺ influx during the hyperpolarization step (Fig. 4). This 3-voltage-step protocol was conducted under various extracellular Ca²⁺ concentrations (0, 2, 5, 10 and 20 mM). The differences in mean current between the two depolarization steps increased as the extracellular Ca²⁺ concentration increased (Fig. 5). This current could be reduced by adding 1 mM Gd³⁺ (Fig. 5). The Ca²⁺ dependency of the protocol could also be reproduced qualitatively with the OoClamp, since the differences in mean current between the two depolarization steps increased as the Ca²⁺ concentration increased at the membrane patch (Fig. 6).

In the context of the 2nd Swiss Parabolic Flight Campaign, we tested the method and hardware described above. Furthermore, we examined if the Ca²⁺-dependent current was also gravity dependent. Measurements were conducted under 1 g and microgravity conditions. Due to the limited space and the limited number of parabolas, only nine oocytes could be flown. As described in the Materials and Methods section, data were only included if the seal resistance was greater than 65 kOhm and a clear current transient was visible upon applying a voltage step. Data from two oocytes had to be excluded completely, as did parts of the data from four oocytes. All of the data from three oocytes could be used. One oocyte was used in the second to last and in the last block of parabolas. The last block of parabolas included the two partial gravities equal to those of the Moon and Mars. Because for each partial gravity only one recording could be acquired, these two data points were excluded from the data analysis. Due to the small data base, a conclusive statement was not possible. However, overall, the difference in mean current between the two depolarization steps tended to be smaller under microgravity than under the 1 g condition (Fig. 7).

To determine the seal resistance, a series of voltage steps was executed before each application of the 3-voltage-step protocol. The time constant of the resulting current transient was computed from the two largest voltage steps—from -30 to -100 mV and from 100 to -30 mV. This time constant indicates how quickly the capacitance of the lipid membrane is charged. The time constants determined under the 1 g and microgravity conditions were compared. Overall, the time constant was longer under microgravity than under the 1 g condition, but again a conclusive statement was not possible (Fig. 8).

4. Discussion and conclusion

We have developed and tested a method that allows for Ca²⁺-dependent current in *Xenopus laevis* oocytes to be measured during parabolic flights. Conducting experiments in an aircraft performing parabolic maneuvers comes with a number of requirements and constraints. To increase the statistical significance, an experimental design was chosen that allowed the oocytes to be exchanged in flight. Because the dedicated pause between blocks of subsequent parabolas was limited, the oocyte replacement needed to be quick and easy to perform. We therefore introduced the custom-made OoClamp, which does not require micromanipulation of glass pipettes, as is the case with the TEVC. This major advantage comes at the cost of some limitations. First, no micro-pipettes guarantee electrical access to the cytosol, so access to the cytosol needs to be created with a membrane permeabilizing agent such as saponin. Saponin has the advantage of creating electrical access within several seconds and not damaging the membrane too much, such that the oocytes remained intact for the duration of the experiments. However, the impedance of the electrical access currently cannot be reliably quantified. Nevertheless, data from the ground-based studies indicate that access with sufficiently low impedance was created. If the 3-voltage-step protocol was applied to an oocyte before saponin was injected, the

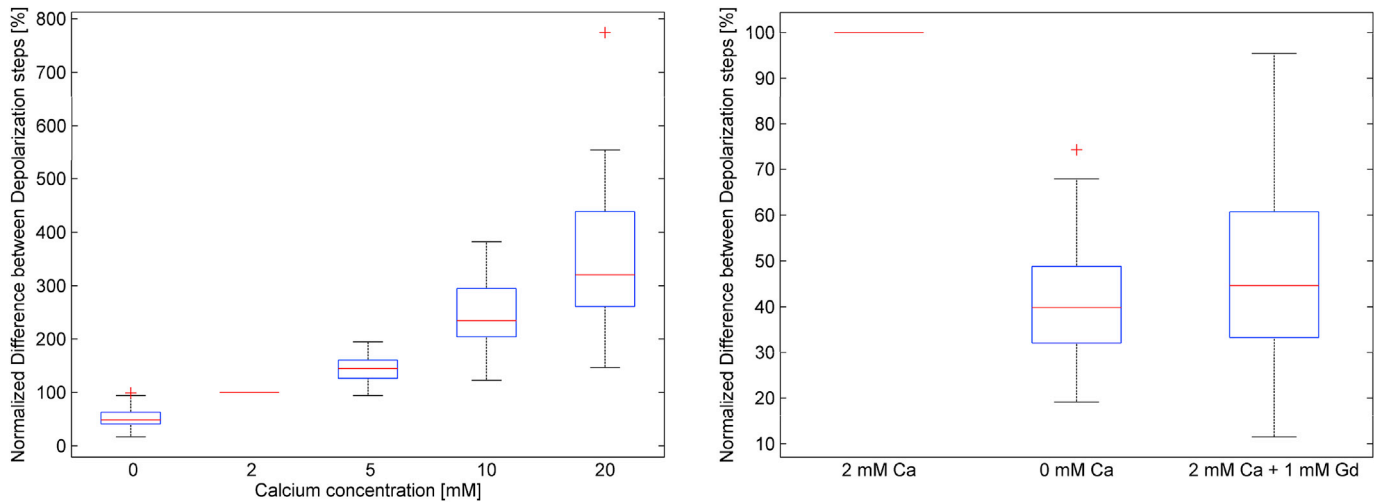

Fig. 5. Results from the TEVC. The 3-voltage-step protocol was conducted under various extracellular Ca^{2+} concentrations (0, 2, 5, 10 and 20 mM). The differences in mean current between the two depolarization steps increased as the extracellular Ca^{2+} concentration increased. This effect could be reduced by adding 1 mM Gd^{3+} . The acquired currents were normalized (per oocyte) to the standard perfusion with 100Na containing 2 mM Ca^{2+} . The central red line represents the median. The edges of the box represent the 25th and 75th percentiles, respectively. The whiskers extend to the most extreme data points, excluding outliers, which are plotted individually. The Ca^{2+} -dependency experiment was repeated on 47 oocytes and the Gd^{3+} -dependency experiment was repeated on 42 oocytes, originating from different 3 frogs. (For interpretation of the references to colour in this figure legend, the reader is referred to the web version of this article.)

strong decreasing current seen during the hyperpolarization step (Fig. 4) remained constant. This indicated a pure ohmic resistance, and the corresponding current represented the seal resistance between the oocyte and the silicone chip. Furthermore, no difference in mean current between the two depolarization steps was detectable before saponin was injected into the upper compartment of the recording chamber. A second limitation was that the measurement was done across a small membrane patch. With the TEVC, the entire membrane of the oocyte contributed to the signal. Since the area of the membrane patch in the OoClamp was approximately 40 times smaller than the surface area of the whole cell, a correspondingly smaller signal was expected. Finally, the seal resistance

formed between the oocyte and the silicone chip was, at best, a few hundred kOhms and was much smaller than in regular patch clamping, for instance. This explains why the absolute currents were well within the microampere range (Fig. 4). Because of these limitations, the 3-voltage-step protocol had to be adjusted for the OoClamp.

A 3-voltage-step protocol, adapted from Courjaret et al. [32], was used to trigger a current, which depended on the extracellular Ca^{2+} concentration. Data recorded by the TEVC showed that the current increased with increasing extracellular Ca^{2+} concentration, and that the current could be reduced by the application of Gd^{3+} (Fig. 5). Gd^{3+} is a nonspecific ion channel blocker, that is also known to block Ca^{2+} -dependent currents [33–38] and MSCs [39]. The Ca^{2+} dependency of the protocol could also be reproduced qualitatively with the OoClamp (Fig. 6). The difference between the two setups can be explained by the limitations of the OoClamp (discussed above).

In the context of the 2nd Swiss Parabolic Flight, we tested the method presented here and examined if the Ca^{2+} -dependent current was also gravity dependent. Due to limited space and limited repetitions of parabolas, only nine oocytes could be measured in flight. Because part of the data had to be excluded, the overall data base became too small to make a conclusive statement. However, the overall tendency was that the differences in mean current between the two depolarization steps were smaller under microgravity than under the 1 g condition. This could indicate that some ion channels have a reduced open state probability in microgravity. As a side observation, we noticed that the time constant of the current transient seen at voltage steps tended to be longer under microgravity than under the 1 g condition. This suggests that the capacitance of the lipid membrane was charged more slowly under the microgravity condition. However, it was impossible to determine what exactly caused a change in the time constant with the OoClamp described here. A change in the capacitance of the upper (permeabilized) and/or lower (patched) membrane and/or a change in the electrical resistances between the upper and lower electrodes may have led to the observed change in the time constant.

In previous experiments, the viscosity of lipid membranes decreased (became more fluid) under low gravity condition [6]. Increasing fluidity, due to rising temperature [40–42] or membrane tension [43], correlates with membrane thinning. The thinning of the membrane in return would increase the capacitance of the membrane, which could explain the longer time constant. The membranes of plain lipid vesicle have shown a

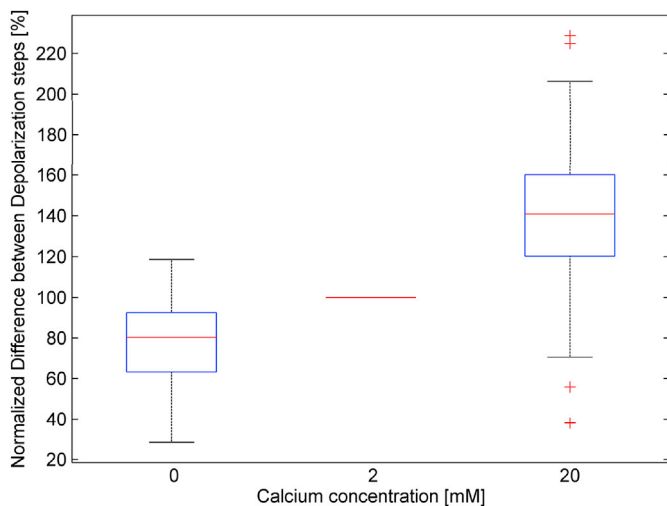

Fig. 6. Results from the OoClamp. The 3-voltage-step protocol was conducted under three extracellular Ca^{2+} concentrations (0, 2 and 20 mM). Similar to the results with the TEVC, the differences in mean current between the two depolarization steps increased as the extracellular Ca^{2+} concentration increased. The acquired currents were normalized (per oocyte) to the standard perfusion with 100Na containing 2 mM Ca^{2+} . The central red line represents the median. The edges of the box represent the 25th and 75th percentiles, respectively. The whiskers extend to the most extreme data points, excluding outliers, which are plotted individually. The experiment was repeated on 66 oocytes from different 3 frogs. (For interpretation of the references to colour in this figure legend, the reader is referred to the web version of this article.)

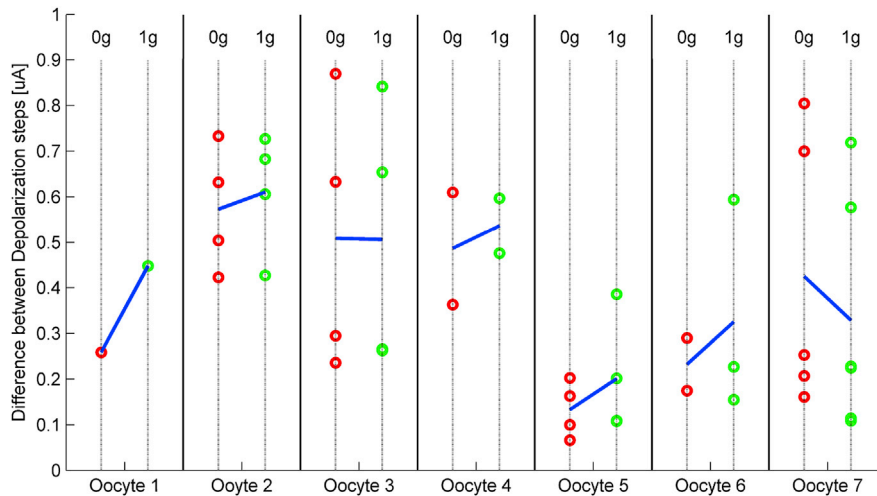

Fig. 7. The 3-voltage-step protocol conducted under 1 g and microgravity conditions. The plot indicates the differences in mean current between the two depolarization steps of all data points that could be included. Red circles indicate the microgravity condition, whereas the green circles indicate the 1 g condition. The blue lines indicate the linear regression. Overall, the differences in mean current between the two depolarization steps tended to be larger under 1 g than under the microgravity condition. (For interpretation of the references to colour in this figure legend, the reader is referred to the web version of this article.)

slightly higher capacity in hyper- and microgravity during a parabolic flight. However, the authors could not rule out that the effect was due to changes in membrane geometry [44]. Since the properties of membranes

are thought to influence the behavior of membrane proteins, including ion channels [1], gravity could influence the gating properties of specific ion channels. In fact, this was detected in several previous experiments

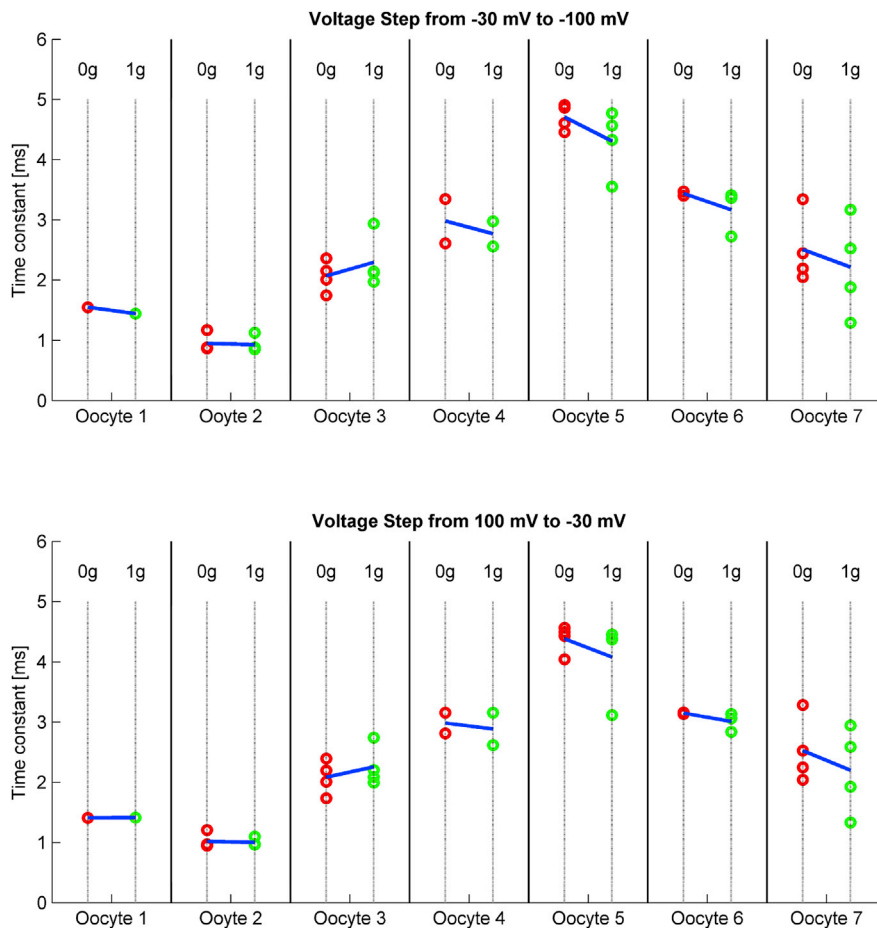

Fig. 8. The time constant of the resulting current transient was computed from two voltage steps: from -30 to -100 mV (top) and from 100 to -30 mV (bottom). The plots show all data that were included. The red circles indicate the microgravity condition, whereas the green circles indicate the 1 g condition. The blue lines indicate the linear regression. Overall, the time constant tended to be longer under microgravity than under the 1 g condition. (For interpretation of the references to colour in this figure legend, the reader is referred to the web version of this article.)

[10–14]. The data obtained during the test flight suggest that the transmembrane Ca^{2+} -dependent current could be reduced under microgravity. This is in agreement with the results from previous experiments [10,13,14]. The current provoked with the 3-voltage-step protocol could also be blocked with Gd^{3+} . Gd^{3+} is also known to block MSCs [39], including in native *Xenopus laevis* oocytes [45].

In conclusion, the OoClamp setup and the experiment protocol worked well during the parabolic flight. The data presented here suggest that the transmembrane Ca^{2+} -dependent current could be reduced under microgravity conditions. In addition, the time constant of the current transient tended to be longer under microgravity, which suggests that the membrane capacitance was charged more slowly. However, a conclusive statement was not possible due to the limited amount of data that could be acquired. We have therefore applied for upcoming parabolic flight campaigns.

Conflicts of interest

The authors declare that they have no conflicts of interest.

Acknowledgements

We thank Ian Forster, Eva Hänsenberger and Simone Camargo from the University of Zurich for providing us with oocytes and helping us with their expertise. We also thank Benjamin Gantenbein from the University of Bern for our fruitful collaboration. We thank Stéphane Richard from the Lucerne School of Engineering and Architecture for his support during this project. Furthermore, we thank the Swiss Space Office (SSO) and the Swiss Space Center (SSC) (Reference number: REF-1131-61001) for their financial support. Ultimately, we thank Oliver Ullrich and his team from the University of Zurich, the Swiss SkyLab Foundation and Novespace for organizing the 2nd Swiss Parabolic Flight Campaign.

References

- [1] A. Anishkin, S.H. Loukin, J. Teng, C. Kung, Feeling the hidden mechanical forces in lipid bilayer is an original sense, *Proc. Natl. Acad. Sci. U. S. A.* 111 (2014) 7898–7905.
- [2] T. Benavides Damm, M. Egli, Calcium's role in mechanotransduction during muscle development, *Cell. Physiol. Biochem.* 33 (2014) 249–272.
- [3] O.P. Hamill, Twenty odd years of stretch-sensitive channels, *Pflugers Arch.* 453 (2006) 333–351.
- [4] F. Sachs, Stretch-activated ion channels: what are they? *Physiol. (Bethesda)* 25 (2010) 50–56.
- [5] F. Sachs, C.E. Morris, Mechanosensitive ion channels in nonspecialized cells, *Rev. Physiol. Biochem. Pharmacol.* 132 (1998) 1–77.
- [6] M. Sieber, W. Hanke, F.P.M. Kohn, Modification of membrane fluidity by gravity, *Open J. Biophys.* 04 (04) (2014) 7.
- [7] D. Williams, A. Kuipers, C. Mukai, R. Thirsk, Acclimation during Space Flight: Effects on Human Physiology, vol. 180, CMAJ: Canadian Medical Association journal = journal de l'Association medicale canadienne, 2009, pp. 1317–1323.
- [8] J. Pietsch, J. Bauer, M. Egli, M. Infanger, P. Wise, C. Ulbrich, D. Grimm, The effects of weightlessness on the human organism and mammalian cells, *Curr. Mol. Med.* 11 (2011) 350–364.
- [9] G. Albrecht-Buehler, Possible Mechanisms of Indirect Gravity Sensing by Cells, vol. 4, ASGSB bulletin: Publication of the American Society for Gravitational and Space Biology, 1991, pp. 25–34.
- [10] M. Goldermann, W. Hanke, Ion channel are sensitive to gravity changes, *Microgravity Sci. Technol.* 13 (2001) 35–38.
- [11] W. Hanke, Studies of the interaction of gravity with biological membranes using alamethicin doped planar lipid bilayers as a model system, *Adv. Space Res.* 17 (1996) 143–150.
- [12] N. Klinke, M. Goldermann, W. Hanke, The properties of alamethicin incorporated into planar lipid bilayers under the influence of microgravity, *Acta Astronaut.* 47 (2000) 771–773.
- [13] S. Richard, D. Henggeler, F. Ille, S. Vadrucchi Beck, M. Moeckli, I.C. Forster, A. Franco-Obrigón, M. Egli, A semi-automated electrophysiology system for recording from *Xenopus* oocytes under microgravity conditions, *Microgravity Sci. Technol.* 24 (2012) 237–244.
- [14] D.F. Schaffhauser, O. Andriani, C. Ghezzi, I.C. Forster, A. Franco-Obrigón, M. Egli, P.S. Dittich, Microfluidic platform for electrophysiological studies on *Xenopus laevis* oocytes under varying gravity levels, *Lab a Chip* 11 (2011) 3471–3478.
- [15] K. Meissner, W. Hanke, Action potential properties are gravity dependent, *Microgravity Sci. Technol.* 17 (2005) 38–43.
- [16] W. Hanke, M.V. Fernandes de Lima, M. Wiedemann, K. Meissner, Microgravity dependence of excitable biological and physicochemical media, *Protoplasma* 229 (2006) 235–242.
- [17] M. Wiedemann, V.M. Fernandes de Lima, W. Hanke, Gravity dependence of waves in the retinal spreading depression and in gel type Belousov-Zhabotinsky systems, *Phys. Chem. Chem. Phys.* 4 (2002) 1370–1373.
- [18] W. Hanke, M. Wiedemann, V.M. Fernandes de Lima, Control of the excitability of neuronal tissue by weak external forces, *Faraday Discuss.* 120 (2002) 237–248.
- [19] M. Wiedemann, W. Hanke, Gravity sensing in the central nervous system, *J. Gravitational Physiol. J. Int. Soc. Gravitational Physiol.* 9 (2002) P43–P44.
- [20] M.J. Berridge, P. Lipp, M.D. Bootman, The versatility and universality of calcium signalling, *Nat. Rev. Mol. Cell Biol.* 1 (2000) 11–21.
- [21] K. Meissner, J.R. Piqueira, W. Hanke, Fluorescent and dispersion experiments on biological membranes under micro-gravity, *J. Gravitational Physiol. J. Int. Soc. Gravitational Physiol.* 11 (2004) P195–P196.
- [22] F.P.M. Kohn, High throughput fluorescent screening of membrane potential and intracellular calcium concentration under variable gravity conditions, *Microgravity Sci. Technol.* 25 (2012) 113–120.
- [23] J. Hauslage, M. Abbrecht, L. Hanke, R. Hemmersbach, C. Koch, W. Hanke, F.P.M. Kohn, Cytosolic calcium concentration changes in neuronal cells under clinorotation and in parabolic flight missions, *Microgravity Sci. Technol.* 28 (2016) 633–638.
- [24] P.R. Richter, M. Schuster, H. Wagner, M. Lebert, D.P. Hader, Physiological parameters of gravitaxis in the flagellate *Euglena gracilis* obtained during a parabolic flight campaign, *J. Plant Physiol.* 159 (2002) 181–190.
- [25] P. Richter, M. Lebert, H. Tahedl, D.P. Hader, Calcium is involved in the gravitactic orientation in colorless flagellates, *J. Plant Physiol.* 158 (2001) 689–697.
- [26] N. Hausmann, S. Fengler, A. Hennig, M. Franz-Wachtel, R. Hampp, M. Neef, Cytosolic calcium, hydrogen peroxide and related gene expression and protein modulation in *Arabidopsis thaliana* cell cultures respond immediately to altered gravitation: parabolic flight data, *Plant Biol.* 16 (Suppl 1) (2014) 120–128.
- [27] W. Weber, Ion currents of *Xenopus laevis* oocytes: state of the art, *Biochimica Biophys. Acta* 1421 (1999) 213–233.
- [28] W.M. Weber, Endogenous ion channels in oocytes of *xenopus laevis*: recent developments, *J. Membr. Biol.* 170 (1999) 1–12.
- [29] W. Stühmer, A.B. Parekh, Electrophysiological recordings from *Xenopus* oocytes, in: B. Sakmann, E. Neher (Eds.), *Single-channel Recording*, Springer, US, Boston, MA, 1995, pp. 341–356.
- [30] P. Seeman, D. Cheng, G.H. Iles, Structure of membrane holes in osmotic and saponin hemolysis, *J. Cell Biol.* 56 (1973) 519–527.
- [31] C. Oliver, M.C. Jamur, *Immunocytochemical Methods and Protocols*, third ed., Humana Press, 2010.
- [32] R. Courjaret, S. Hubrack, A. Daalis, M. Dib, K. Machaca, The *Xenopus* TRPV6 homolog encodes a Mg^{2+} -permeant channel that is inhibited by interaction with TRPC1, *J. Cell. Physiol.* 228 (2013) 2386–2398.
- [33] B.A. Biagi, J.J. Eneart, Gadolinium blocks low- and high-threshold calcium currents in pituitary cells, *Am. J. Physiol.* 259 (1990) C515–C520.
- [34] L.M. Boland, T.A. Brown, R. Dingleline, Gadolinium block of calcium channels: influence of bicarbonate, *Brain Res.* 563 (1991) 142–150.
- [35] G.W. Bourne, J.M. Trifaro, The gadolinium ion: a potent blocker of calcium channels and catecholamine release from cultured chromaffin cells, *Neuroscience* 7 (1982) 1615–1622.
- [36] R.J. Docherty, Gadolinium selectively blocks a component of calcium current in rodent neuroblastoma x glioma hybrid (NG108-15) cells, *J. Physiol.* 398 (1988) 33–47.
- [37] B. Mlinar, J.J. Eneart, Block of current through T-type calcium channels by trivalent metal cations and nickel in neural rat and human cells, *J. Physiol.* 469 (1993) 639–652.
- [38] C.R. Roland, B. Naziruddin, T. Mohanakumar, M.W. Flye, Gadolinium blocks rat Kupffer cell calcium channels: relevance to calcium-dependent prostaglandin E2 synthesis and septic mortality, *Hepatology* 29 (1999) 756–765.
- [39] Y.A. Ermakov, K. Kamaraju, K. Sengupta, S. Sukharev, Gadolinium ions block mechanosensitive channels by altering the packing and lateral pressure of anionic lipids, *Biophys. J.* 98 (2010) 1018–1027.
- [40] V.I. Gordeliy, V. Cherezov, J. Teixeira, Strength of thermal undulations of phospholipid membranes, *Phys. Rev. E, Stat. Nonlinear, Soft Matter Phys.* 72 (2005) 061913.
- [41] J.H. Ipsen, O.G. Mouritsen, M. Bloom, Relationships between lipid membrane area, hydrophobic thickness, and acyl-chain orientational order. The effects of cholesterol, *Biophys. J.* 57 (1990) 405–412.
- [42] N. Kucerka, M.P. Nieh, J. Katsaras, Fluid phase lipid areas and bilayer thicknesses of commonly used phosphatidylcholines as a function of temperature, *Biochimica Biophys. Acta* 1808 (2011) 2761–2771.
- [43] A.S. Reddy, D.T. Warshaviak, M. Chachisvilis, Effect of membrane tension on the physical properties of DOPC lipid bilayer membrane, *Biochimica Biophys. Acta* 1818 (2012) 2271–2281.
- [44] M. Sieber, S. Kaltenbach, W. Hanke, F.P.M. Kohn, Conductance and capacity of plain lipid membranes under conditions of variable gravity, *J. Biomed. Sci. Eng.* 09 (08) (2016) 6.
- [45] X.C. Yang, F. Sachs, Block of stretch-activated ion channels in *Xenopus* oocytes by gadolinium and calcium ions, *Science* 243 (1989) 1068–1071.



Simon L. Wuest. After completing the apprenticeship as a mechanic, Simon Wüest studied Systems Engineering (bachelor) at the University of Applied Sciences Northwestern Switzerland. Subsequently he studied Biomedical Engineering (master) at the University of Bern. As a part-time student he also worked as an assistant at the University of Applied Sciences Northwestern Switzerland. He developed so-called Random Positioning Machines (RPM), which are used to expose biological samples to simulated microgravity. Currently he is doing his PhD in Biomedical Engineering in a collaborative work of the Lucerne School of Engineering and Architecture and the University of Bern.



Dr. Fabian Ille received his degree in biology at the Interdisciplinary Centre for Scientific Computing of the Ruperta Carola University of Heidelberg, where he has gained expertise with *in-silico* modelling of low-energy pathways for complex rearrangements in proteins. He later received a PhD in Neurobiology at the ETH-Zurich and accomplished the international PhD program in Neuroscience at the Neuroscience Centre Zurich. He was the proprietor of an IT company (Germany) concerned with the development and implementation of production database solutions for industrial purposes. He currently works as scientific group leader and lecturer at the Institute for Medical Engineering, Lucerne School of Engineering and Architecture.



Christian Roesch. After a four-year apprenticeship as electronics technician, Christian Roesch studied biology at the University of Bern. In his bachelor and master thesis, he investigated difference in feeding behavior among rapid specifying whitefish radiation in Swiss lakes. He is currently working in ESA's human space flight environment and is planning, supervising and supporting cell biological experiments in the science laboratory COLUMBUS on board the International Space Station.



Prof. Dr. Marcel Egli is head of the Institute of Medical Engineering, the "Space Biology Group", at the Lucerne School of Engineering and Architecture. After graduating from the University of Bern, he spent several years as postdoctoral fellow at the University of Melbourne and at the Florida State University. Later on, an appointment to lead the Space Biology Group brought him back to Switzerland. Marcel Egli has published numerous papers and in the fields of neurobiology and space biology. His research interests include mainly cellular mechanisms of mechanosensation, investigated on research platforms like the International Space Station.