

## WFS-1

# Advanced RF, Microwave and Millimeter Wave Energy Based Systems to Address A Range of Unmet and Growing Clinical Needs

Prof. Chris Hancock

CTO and Founder (Creo Medical Group PLC)

Chair Medical Microwave Systems Group (Bangor University)

# Thermal and Non-Thermal Systems

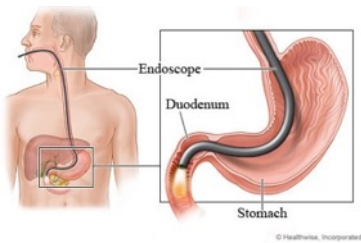
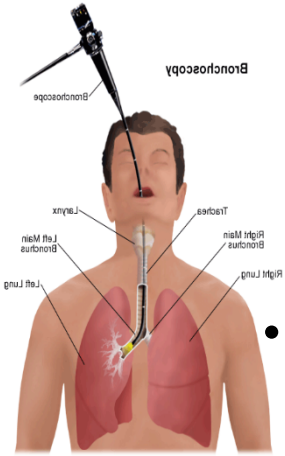

- Thermal Systems:
  - 5.8GHz and 400KHz energy for new advanced therapeutic procedures – ESD, POEM, Haemostatis, Lung Tumors, NOTES. Delivery through natural orifices
  - 14.5GHz energy with dynamic impedance matching for open surgical applications and the treatment of GERD and skin cancer
- Non-Thermal Systems
  - Plasma systems for wound care, treating hospital infections, cleaning and selective cell apoptosis
  - Cell movement using electrophoresis and enhancement using mm-wave energy for regenerative medicine
  - Irreversible Electroporation

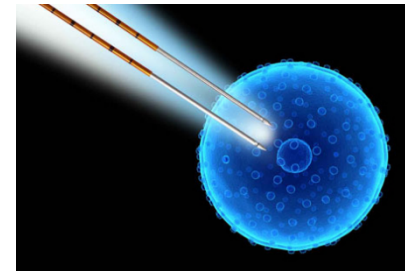

Thermal energy delivered into the GI tract by insertion into the instrument channel of a therapeutic endoscope for treating lesions in the lower GI tract – 400KHz bipolar RF to cut, 5.8GHz microwave to controllably coagulate to controlled depth



Endoscopic Procedure

- 16m screening colonoscopies are performed per annum in the US
- 1.2m will find a lesion which must be treated urgently
- Approximately 50% of those lesions are surgically removed
- But traditional colorectal surgery is associated with a 5% mortality rate at 30 days

**In terms of cancer:**

1 in 21 men and 1 in 23 women develop colorectal cancer – In 2017, there is an estimated 133, 430 colorectal cancer that will be diagnosed.

93, 520 colon cancers  
 39, 910 rectal cancers  
**50,260 will die!**

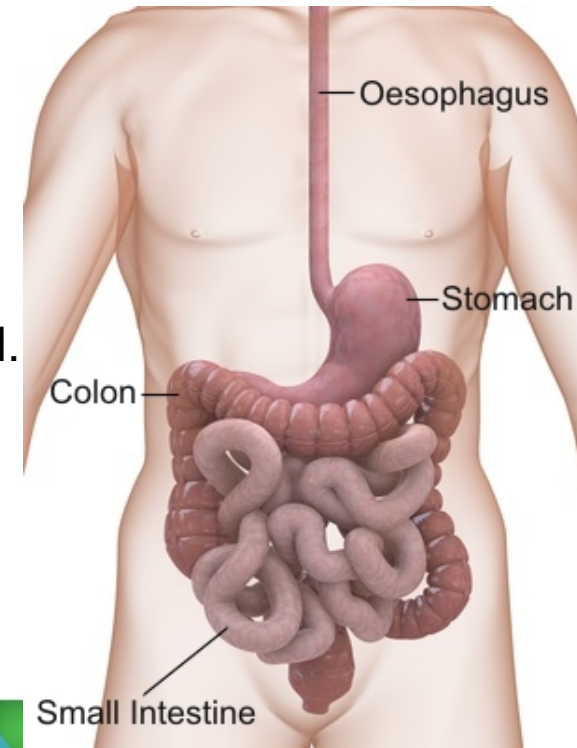
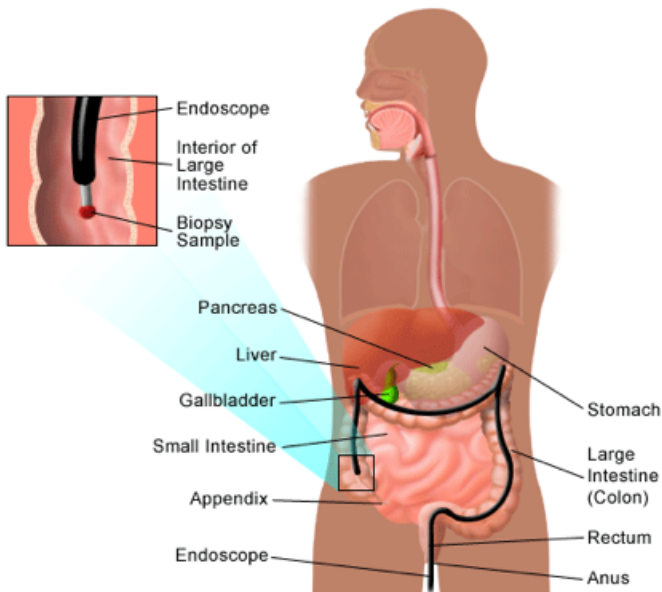



# New Endoscopic Device and Energy System for use in Emerging Non-Invasive Surgical Techniques

## Integrated injection needle

no instrument exchange required

- **400KHz RF Energy** for precise cutting tissue

- **5.8GHz Microwave Energy** for coagulation and ablation

## Microwave coagulation

controlled haemostasis

## Rotation

orientation in any plane

## Protective hull

reduces risk of muscle damage

## Bipolar electrodes

precise lateral and forward dissection

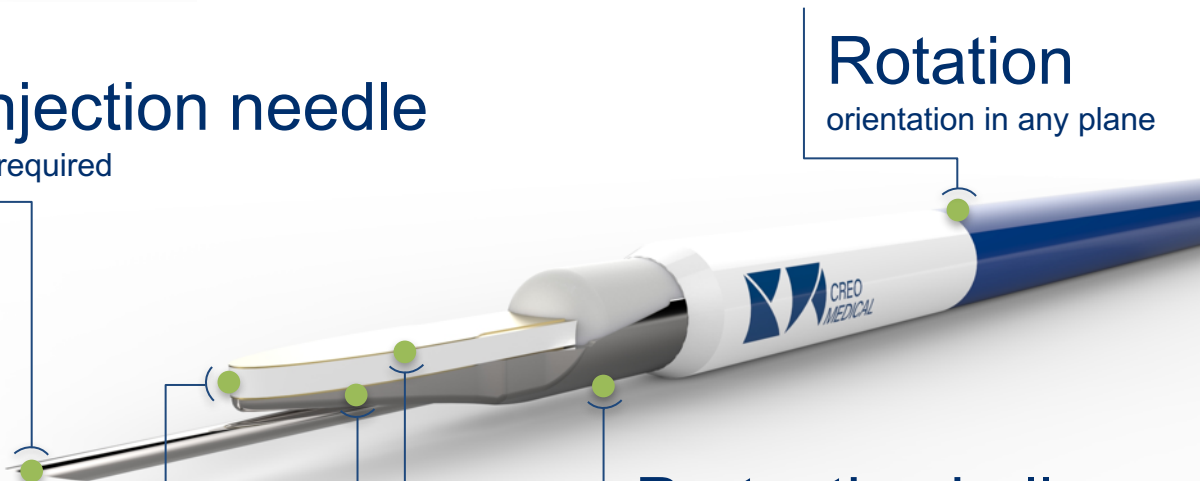

CREO  
MEDICAL

Tsiamoulos, Zacharias P<sup>1</sup>; Rajaratnam, Rameshshanker<sup>2</sup>; Wall, Pete<sup>3</sup>; Cocks, Kim<sup>5</sup>; Hancock, Christopher<sup>4</sup>; Saunders, Brian P.<sup>2</sup>

1. Endoscopy, St Mark's / East Kent / NPIMR, London, United Kingdom. 2. St Mark's, Wolfson Unit for Endoscopy, London, United Kingdom.  
3. Research, ISCA Healthcare Research Limited, London, United Kingdom. 4. Bangor University, School of Electronic Engineering, Bangor, United Kingdom. 5. Research, KCSTATS Limited, London, United Kingdom.

## Introduction

The purpose of the study was to obtain safety and performance data for the **microwave coagulation modality of the CROMA Electrosurgical System** (Creo Medical Ltd, UK) and RS2 resection device to complement existing data and support a **CE Mark application (Figure 1)**.

## Aims

The primary objective was to assess the **safety and efficacy of coagulation using microwave energy** of visible blood vessels and the treatment of oozing/actively bleeding vessels ( $\leq 1\text{mm}$  in diameter) during endoscopic resection of complex colorectal polyps (Figure 2). The secondary objective was the identification and incidence of peri-and post-procedural complications.

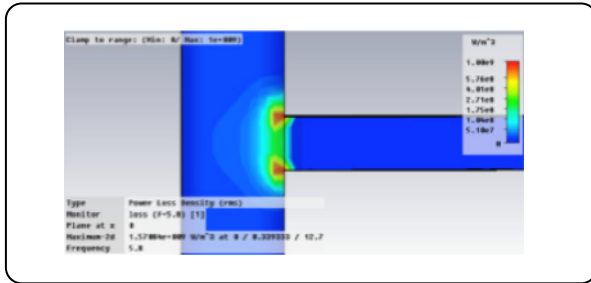

Figure 2: Decreased depth of tissue penetration using high frequency 5.8GHz Microwave coagulation

## Methods

This **MHRA approved study** was a dual centre (St Mark's/London and Queen Elizabeth Queen Mother/Margate, UK), **non-randomised, prospective, non-comparative, prospective pivotal translational trial**.

Patients completed part 1 of the study if vessels were treated with microwave energy during polypectomy and part 2 of the study when they attended for endoscopic follow up at 3-6 months.

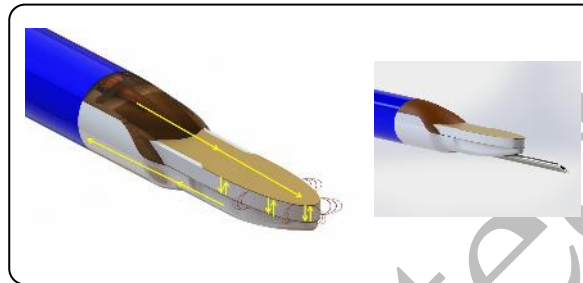

Figure 1: Multi-modality Speedboat RS2 device (RF cut/yellow, microwave coagulation/red and injection)

## Results

Consort Diagram describes in details the enrolment and recruitment process (Figure 3). There were no protocol violations in the study. Patient compliance with the visit schedule for the study was 100%. Patient recruitment was completed in 8.3 months.

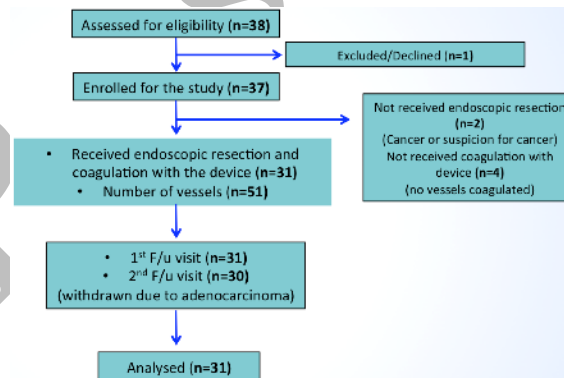

Figure 3: Enrolment and recruitment process

A total of 51 blood vessels were treated, which met the required inclusion criteria in Part 1 of the study. The majority of blood vessels, **98% (50/51) were successfully coagulated** by the microwave device (95% exact CI 89.6% to 100%). The majority of study patients (30/31, 96.8%) had all blood vessels coagulated, which met the study inclusion criteria (95% exact CI 83.3% to 99.9%). The majority of these blood vessels (**29/51, 56.9% were successfully coagulated at first attempt** (95% exact CI 42.3% to 70.7%). One blood vessel could not be coagulated by two applications of microwave energy, but was successfully treated by the use of an endoclip, as per protocol (Table 1).

There were no significant complications or device-related events in the study.

Results	Number of successes / Number of vessels or patients	% (95% exact confidence intervals)
Patients with all vessels successfully coagulated	30/31	96.8% (83.3% to 99.9%)
<b>Vessels successfully coagulated</b>	<b>50/51</b>	<b>98.0 (89.6% to 100.0%)</b>
Vessels successfully coagulated at first attempt	29/51	56.9% (42.3% to 70.7%)
Vessels successfully coagulated by SMH site	36/37	97.3% (85.8% to 99.9%)
Vessels successfully coagulated by GEGM site	14/14	100.0% (76.8% to 100.0%)

Table 1: Results

## Conclusion

Coagulation using microwave energy appears to be a **safe and easy modality to apply**. No serious adverse events were recorded.

**Small vessels ( $\leq 1\text{mm}$  in diameter) were successfully treated at a pre-coagulation or bleeding phase using the microwave coagulation.**

Tsiamoulos ZP et al. A novel multimodality endoscopic device for colonic submucosal dissection using a combination of bipolar radiofrequency and microwave modalities. *Endoscopy*. 2016 Mar;48(3):271-6.

# Clinical Use

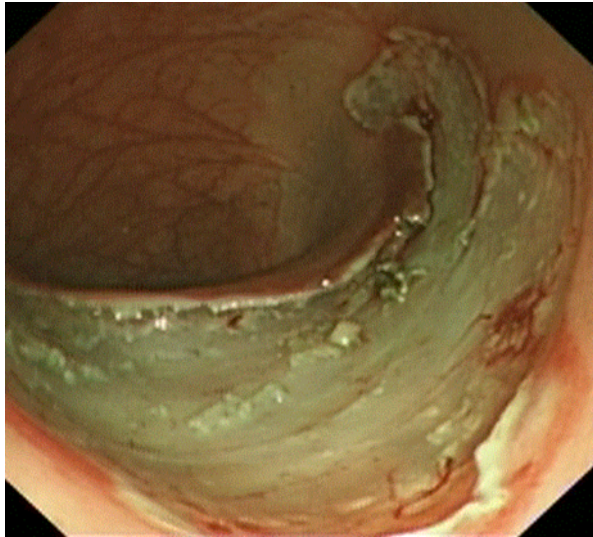
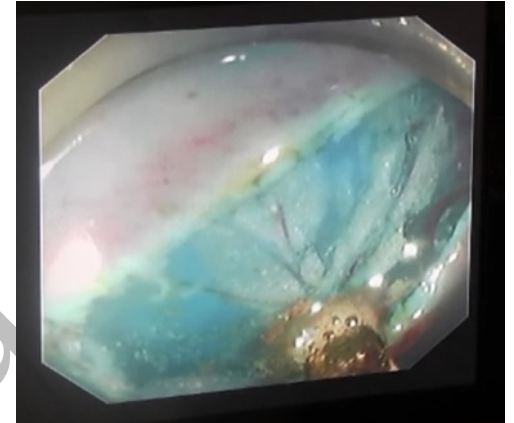
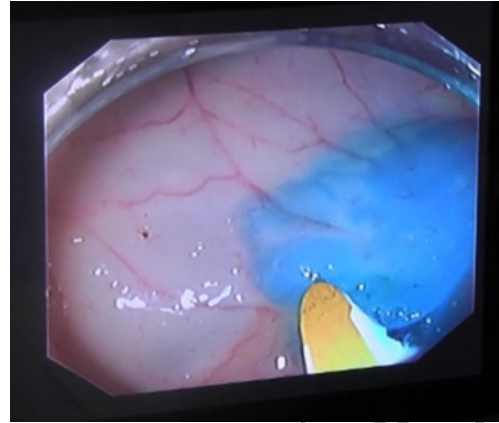
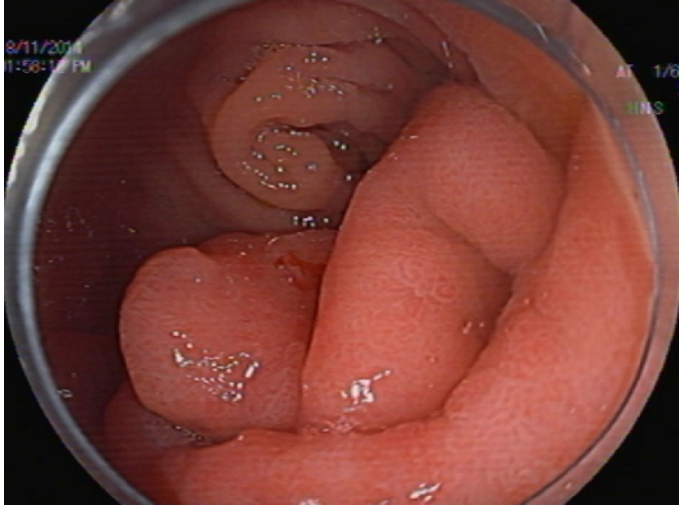



# The 'Speedboat': a new multi-modality instrument for endoscopic resection in the gastrointestinal tract

Saunders B.P.<sup>1</sup>, Tsiamoulos Z.P.<sup>1</sup>, Sibbons P.D.<sup>2</sup>, Bourikas L.A.<sup>3</sup>, Hancock C.<sup>4</sup>

1. Wolfson Unit for Endoscopy, St Mark's Hospital/Academic Institute, London, United Kingdom. 2. Department of Surgical Sciences, Northwick Park Institute  
3. Department of Gastroenterology, University of Crete, Greece. 4. Creo Medical Ltd, University of Bangor, United Kingdom



"This is a summary of independent research funded by the National Institute for Health Research (NIHR) 's Invention for Innovation (i4i) Programme. The views expressed are those of the author(s) and not necessarily those of the NHS, the NIHR or the Department of Health."

## Introduction

Large sessile or flat intestinal lesions >2cm are optimally removed en-bloc for accurate histology and complete resection. Current submucosal dissection devices are technically challenging to use, resulting in long and sometimes incomplete procedures with a relatively high risk of major complication. We describe a simple to use, multimodality endoscopic device ('Speedboat') for wide-field, en-bloc mucosal resection.

## Aims & Methods

The 'Speedboat' cuts in forward, lateral and oblique planes using bipolar radio frequency (RF) cutting, provides haemostasis with microwave coagulation and incorporates a retractable needle for submucosal injection and tissue irrigation. The instrument blade has an insulated 'hull' to prevent thermal injury and the device catheter is partially torque-stable allowing rotation and orientation of the hull to protect the underlying muscularis propria. The electrosurgical generator is comprised of 2 power sources, one operating at 400KHz (RF) and the other at 5.8GHz (microwave). Speedboat submucosal dissection (SSD) technique was performed and video recorded on 4 consecutive 60kg pigs. Mucosal areas to be resected were marked prior to submucosal injection. The mucosa was then circumferentially incised and resected by SSD. The time taken to complete resection, complications encountered and power settings used were recorded. Immediately after the procedure, the animals were euthanised, and the resection defects measured and assessed histologically.

## Results

Eight consecutive resections were performed (2 per animal), 7 in the colorectum and 1 in the antrum of the stomach. The median time to complete a resection was 37 minutes (range: 30-60 minutes) using RF cutting 24W, voltage circa 300Vrms. Median defect size (longest diameter) was 53.5mm, range 40-80mm.

Microwave coagulation was applied for either minor bleeding or visible vessels on 32 occasions (mean energy 7.5W). An endoclip was used once to control arteriolar bleeding but no other haemostatic device was required. There were no perforations and histology showed an intact and viable muscle layer with some remaining submucosa in all cases.

## 'Speedboat' blade, hull and needle



Fig.1: 'Speedboat' blade, hull and needle. Inset: Creo-Medical generator

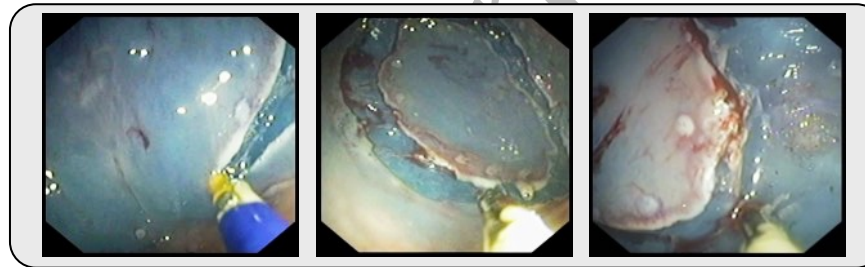

Fig.2: Speedboat Submucosal Dissection (SSD) technique

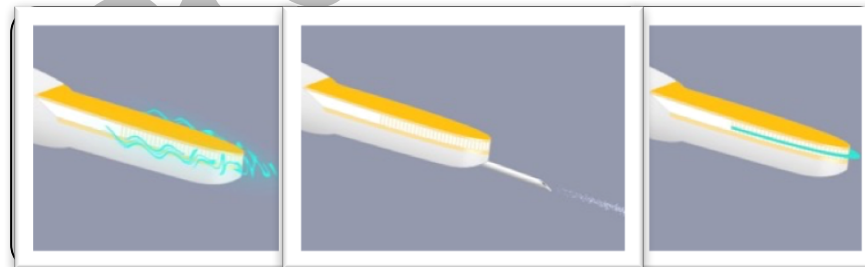

Fig.3: 'Speedboat' modalities:

bipolar radio-frequency (RF) cutting, submucosal injection/irrigation, microwave (MW) coagulation

## In Conclusion

- This initial pre-clinical evaluation study suggests that 'Speedboat' was a successful device for en-bloc resection in the gastrointestinal tract
- It appears to be time efficient with a safety profile
- It has the potential to be utilised in the oesophagus in particular for submucosal tunneling procedures like POEM
- 'Speedboat' merits future survival pre-clinical and human studies

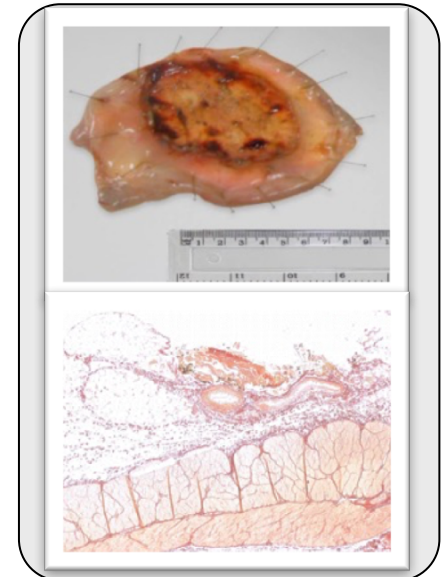

Fig.4: Resection defect & viable muscle layers with Picro-sirius red staining



# The "Speedboat- RS2": a new multi-modality endoscopic device for gastric and oesophageal submucosal dissection and tunneling

Tsiamoulos, Zacharias P.<sup>1</sup>; Hancock, Christopher P.<sup>4</sup>; Bourikas, Leonidas A.<sup>3</sup>; Sibbons, Paul D.<sup>2</sup>; Saunders, Brian P.<sup>1</sup>



1. Wolfson Unit for Endoscopy, St Mark's Hospital/Academic Institute, London, United Kingdom. 2. Department of Surgical Sciences, Northwick Park Institute for Medical Research, London. 3. Department of Gastroenterology, University of Crete, Greece. 4. Creo Medical Ltd, University of Bangor, United Kingdom

"This is a summary of independent research funded by the National Institute for Health Research (NIHR) 's Invention for Innovation (i4i) Programme. The views expressed are those of the author(s) and not necessarily those of the NHS, the NIHR or the Department of Health."

## Introduction

Gastric and oesophageal mucosal lesions are optimally removed en-bloc for accurate histology and complete resection. Current submucosal dissection devices are technically challenging to use, resulting in long procedures with a relatively high risk of major complication. We describe, a simple to use, multi-modality endoscopic device ("Speedboat-RS2") for en-bloc gastric/oesophageal mucosal resection and for oesophagea submucosal tunneling.

## Aims & Methods

The 'Speedboat-RS2' cuts in forward, lateral and oblique planes using bipolar radio frequency (RF,400KHz) cutting, provides haemostasis with microwave coagulation (5.8GHz) and incorporates a retractable needle for submucosal injection and an insulated 'hull' to prevent thermal injury to the muscularis layer. Gastric submucosal dissection and oesophageal submucosal resections/tunneling procedures were performed on 5 consecutive 60kg pigs. All cases were video recorded. The time taken to complete resection/tunneling, complications encountered and power settings used were recorded. Two animals were euthanized immediately (termination study - TS) and three animals were recovered for 3 days (survival study =SS). Submucosal defects and excised flaps were measured and assessed histologically.

## Results

Five (3TS, 2SS) consecutive gastric submucosal dissections, five oesophageal resections {4 (3TS, 1SS) semi and 1 (SS) full circumferential oesophageal mucosal resections} and two submucosal tunneling procedures {1 (SS) with partial myotomy and 1 (TS) with no myotomy} were performed. The median time to complete a gastric resection was 46min range (21-83min) using RF cutting 35W and 41min range (12-50min) using RF cutting 25W for the oesophageal excision/tunneling procedure.

'Speedboat' blade, hull and needle

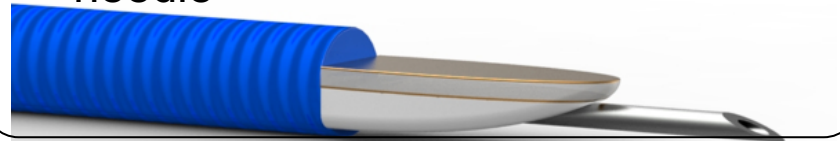

Fig.1: 'Speedboat' device. Inset: Creo Medical generator

## Results

Median gastric defect size was 55mm (range 35-70mm) and median oesophageal defect size was 47mm (range 35-70mm). Microwave coagulation was applied for either minor bleeding or visible vessels on 57 occasions (mean energy 7.5W). No endoscopic or histologic perforations were noted. All excised flaps were appropriate for histological assessment apart from one oesophageal flap that was mildly heat damaged. Gastric and oesophageal muscle layers/serosa were intact and viable. In three oesophageal cases, there was a mild muscle cell alteration but contiguity was retained. In one gastric resection, another dissection knife assisted the last ribbon cut.

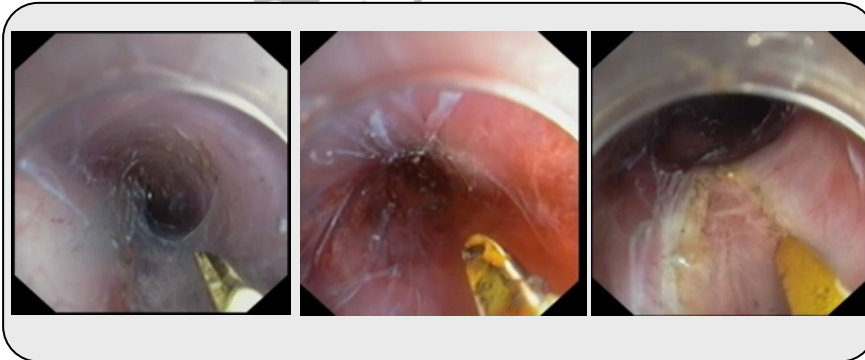

Fig.2: Oesophageal submucosal tunneling ant partial myotomy with 'Speedboat' RS2

## In Conclusion

- This pre-clinical evaluation study suggests that 'Speedboat' was a successful device for en-bloc resection in the stomach and oesophagus.
- It appears to be time efficient with an acceptable safety profile
- It has the potential to be utilised in the oesophagus for ESD and submucosal tunneling procedures such as POEM
- 'Speedboat' merits future survival pre-clinical and human studies

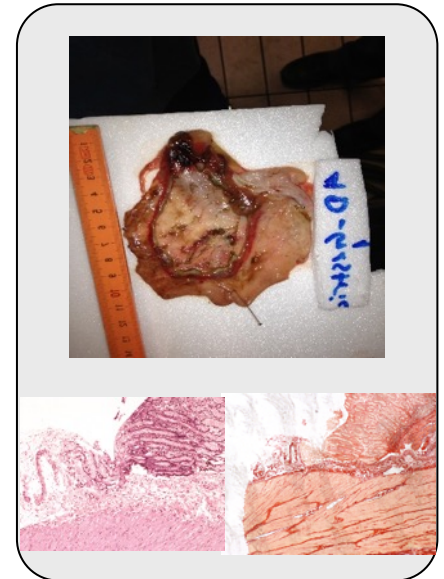

Fig.4: Gastric resection defect & viable muscle layers with Picro-sirius red staining





# Integrated Ablation, Vision and Steering System for Treating Lung Tumors – Advanced Lung Tumor Treatment



- Initial pre-clinical testing showed ability to navigate and visualise up to the 5<sup>th</sup> branch of the bronchial tree

*“Being able to navigate to, biopsy and ablate lesions using a **bronchoscopic** approach would be revolutionary for lung cancer management”*

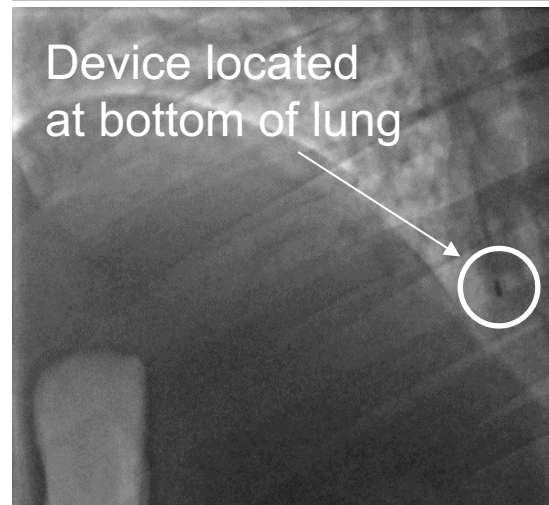

**Dr Pallav Shah**  
Consultant Pulmonologist  
Royal Brompton Hospital, UK

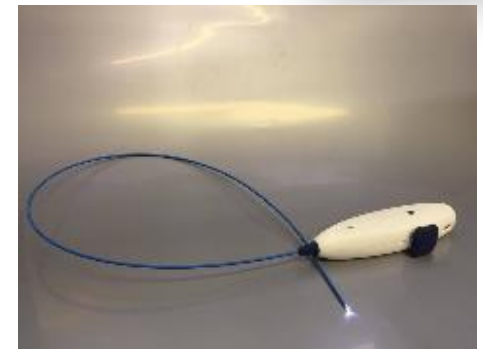
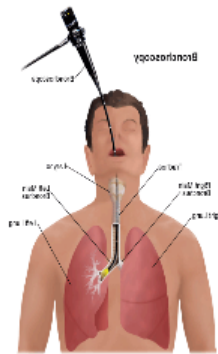

- 1.8m Global cases of lung cancer each year
- 17% Five-year survival rate
- 83% Nodules are considered to be inoperable

Lung cancer is the leading cause of cancer death among men and the second leading cause of cancer death among women worldwide. [1]

[1] Torre, Lindsey A., Rebecca L. Siegel, and Ahmedin Jemal. "Lung cancer statistics." *Lung Cancer and Personalized Medicine*. Springer International Publishing, 2016. 1-19.



# Novel Microwave Energy Based Haemostat – New Microwave Energy Delivery Structure

○ Mortality rate of up to 15% from upper GI bleeding even with current start-of-the-art technology

• Microwave and adrenaline haemostat for use in endoscopic procedures [1]

• Allows for the delivery of adrenaline and microwave energy to accomplish optimal and efficient endoscopic haemostasis.

• Adrenaline controls bleed and microwave energy creates the plug

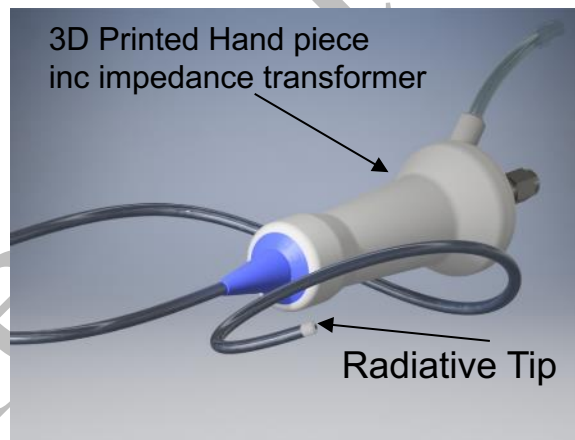
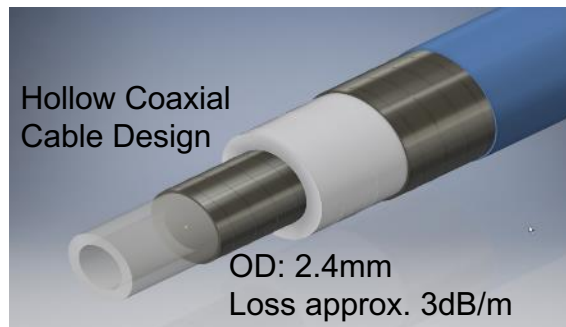

Upper Gastrointestinal Bleeding accounts for over 400,000 hospital admissions annually in the United States and up to 52,000 deaths. [2] In the UK, it causes up to 4000 deaths and around 70,000 hospital admissions per annum. [3]



[1] S. Preston, M. White, B. Saunders, Z. Tsiamoulos, and C. P. Hancock, "A new haemostatic device utilising a novel transmission structure for delivery of adrenaline and microwave energy at 5.8 ghz," in Microwave Conference (EuMC), 2016 46th European. IEEE, 2016, pp. 910–913.

[2] J. H. Hwang, D. A. Fisher, T. Ben-Menachem, V. Chandrasekhara, K. Chathadi, G. A. Decker, D. S. Early, J. A. Evans, R. D. Fanelli, K. Foley et al., "The role of endoscopy in the management of acute non-variceal upper gi bleeding," *Gastrointestinal endoscopy*, vol. 75, no. 6, pp. 1132–1138, 2012.

[3] A. A. Taylor, O. C. Redfern, and M. Pericleous, "The management of acute upper gastrointestinal bleeding: A comparison of current clinical guidelines and best practice," *European Medical Journal*, no. 3, pp. 73– 82, 2014.

# 14.5GHz energy system for treating Breast and Liver Cancer

## Medical Microwave System Developed for the Treatment and Measurement of Breast Tumours

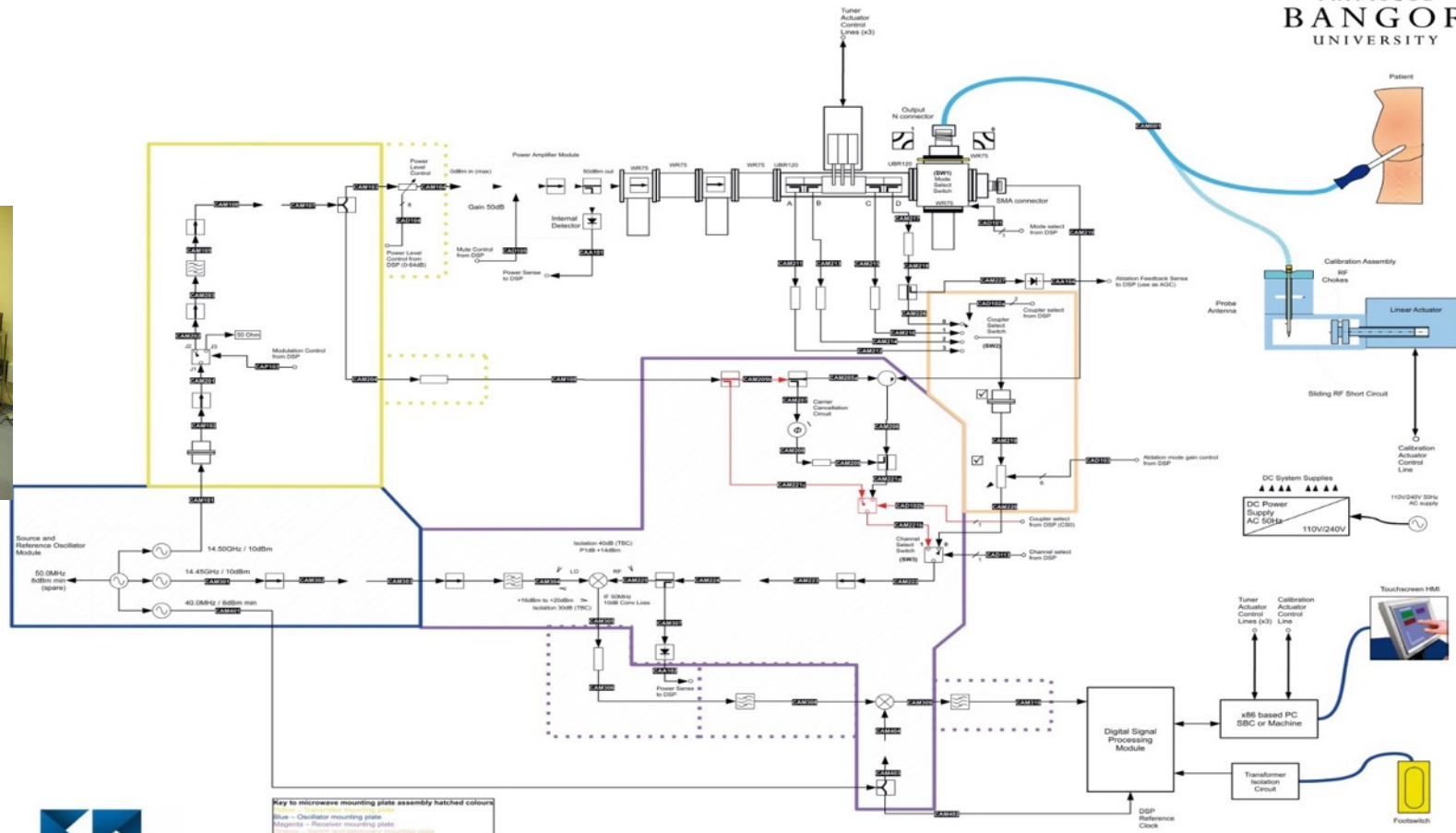
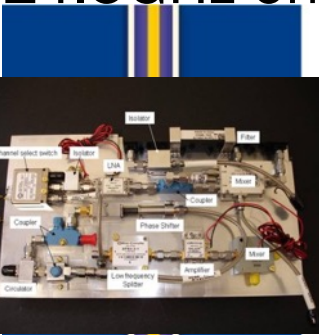

The system also uses a hand-held ultrasound imaging device to provide a basis image of the tumour for location of the probe. The system then measures the dielectric properties of the various tissue structures encountered as the probe is located into the centre of the tumour. The system is able to identify tissue boundaries, which enables the radiating section of the probe to be located exactly at the centre of a spherical tumour.

**Biggest cancer killer in women worldwide: Over 508 000 women died in 2011 due to breast cancer (Global Health Estimates, WHO 2013).**

# 14.5GHz energy system for treating Acid Reflux or GERD

More than 3M cases of acid reflux in the US per year – the solution is to controllably tighten the junction between the oesophagus and the stomach

- Travelling wave antenna structure to operate at 14.5GHz microwave energy
- 14.5GHz enables a suitable antenna geometry that fits the environment and provides a controlled depth of heating
- Designed to provide controlled ablation of the lower esophageal sphincter (LES) to restrict acidic juices coming up from the stomach

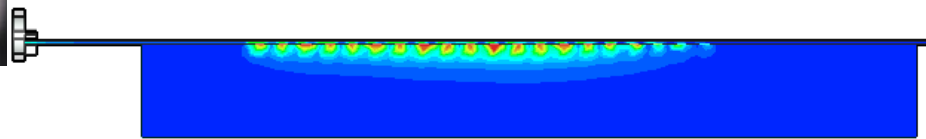
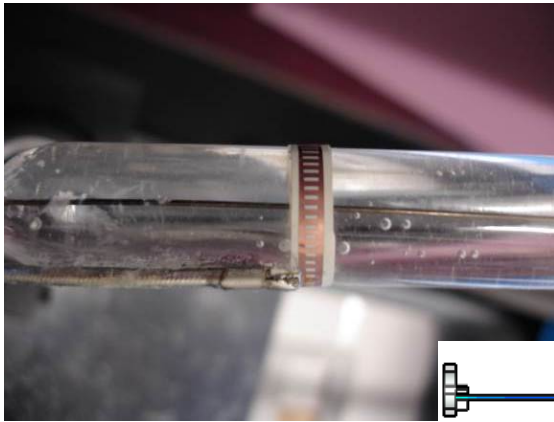

# 14.5GHz Energy System for treating Skin Cancer

- Over 5.4M cases of non-melanoma skin cancer per year in US. Over 4M are basal cell carcinoma (BCC)
- 40-50% Americans who live over 65 will have BCC or Squamous cell carcinoma at least once

Depth of penetration of heating at 14.5GHz suitable for skin structures:

- Epidermis is up to 1.5mm thick
- Dermis is up to 4mm thick

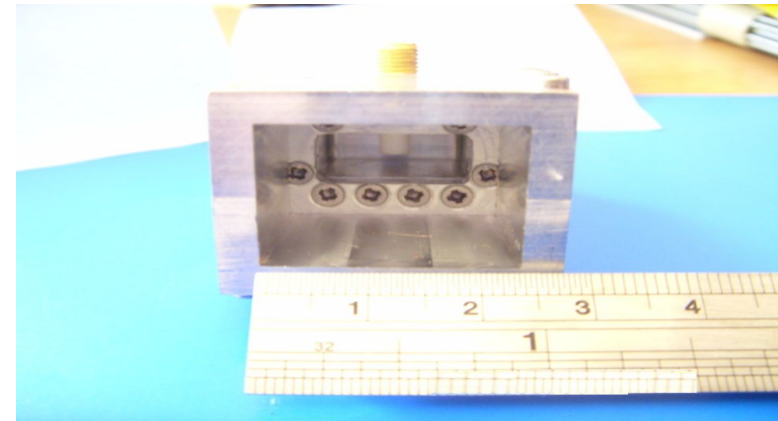
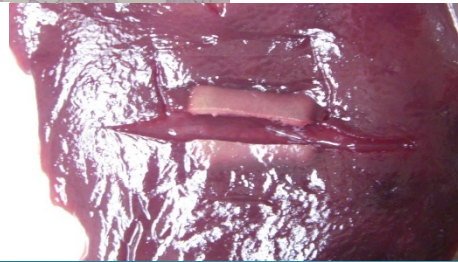
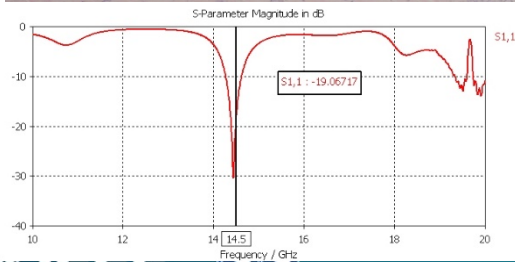
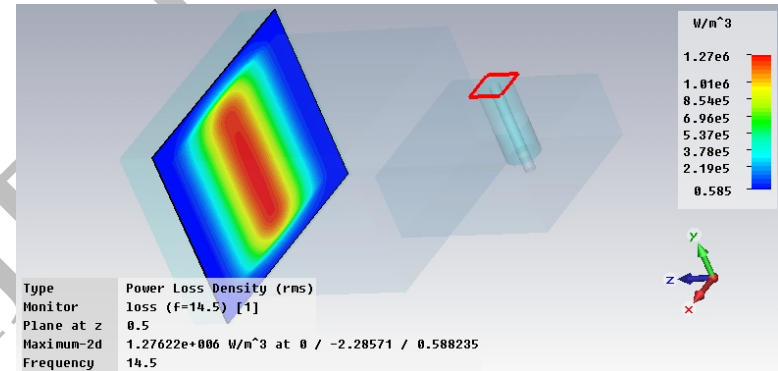
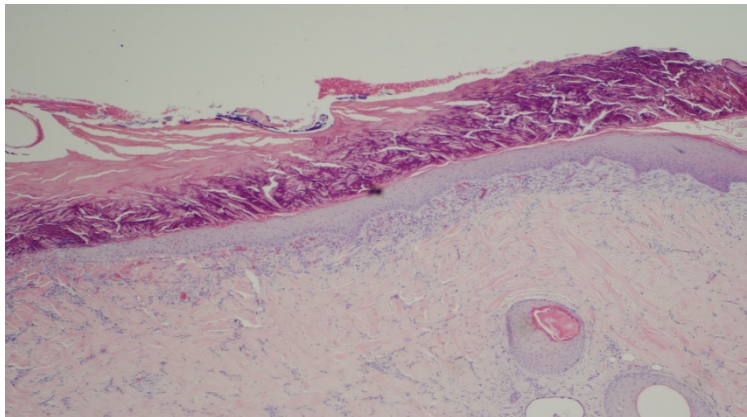

# Non-Thermal Plasma System for Cell Deactivation

## Microwave Energy Sustained Ar Plasma

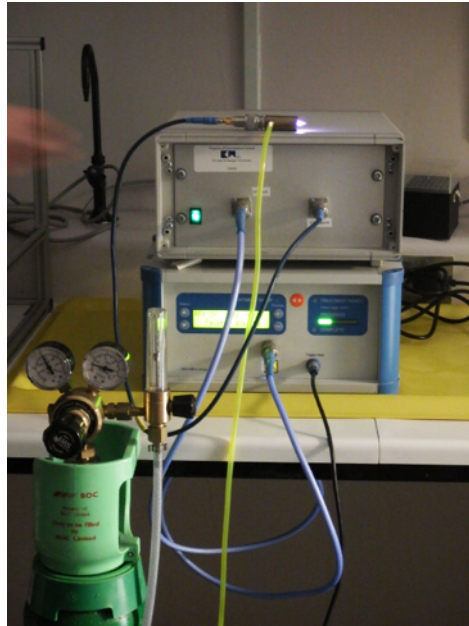
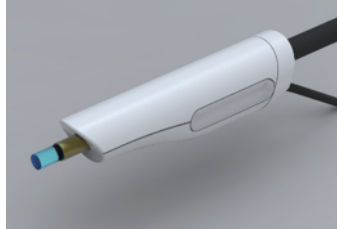

In the US over 80,000 invasive **MRSA** infections and 11,285 related deaths occur every year

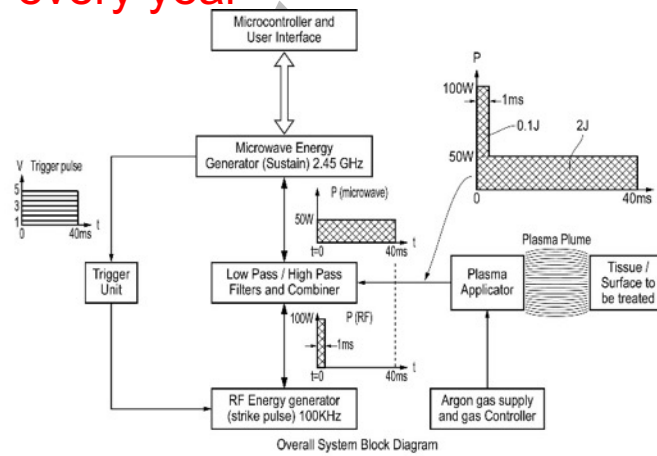
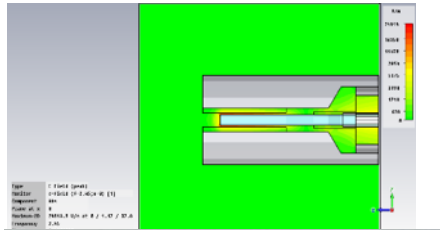
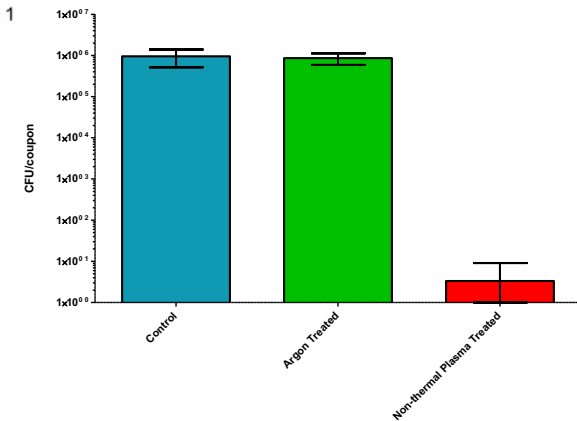

FIG. 1



# Requirements for Tissue engineered organs

Major issue:

Sufficient & viable numbers

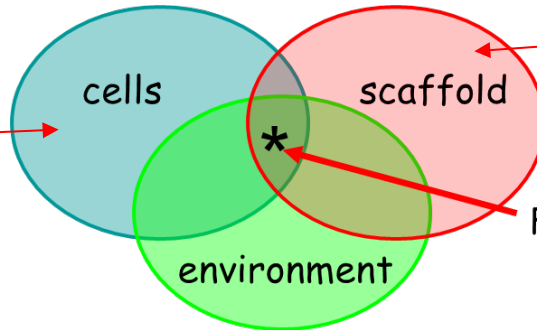

Biologically derived or synthetic

Functional tissue or organ

Potential solution: Electrophoresis to harvest cells from existing tissue biopsies

For example: a tissue engineered trachea / windpipe

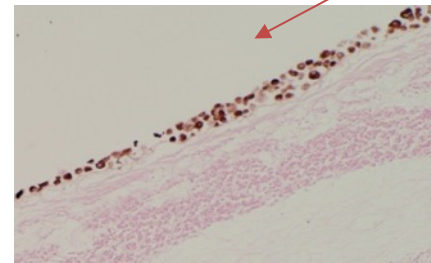
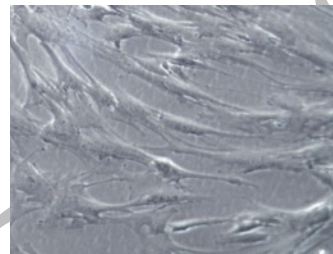

New seeded cells

**Problem:**

lack of direction and attachment

**Solution:**

directional E-field and mm-wave for growth

Tracheal scaffold on mandrel

Cells

Seeded lumen

# Electrophoresis for Tissue Engineering – Moving Cells

This is accomplished using a pulsed DC electric field.  
 New cells can then be introduced using the same device.  
 This is potentially a viable method of harvesting cells from tissue.

Simplified system diagram for PWM circuit

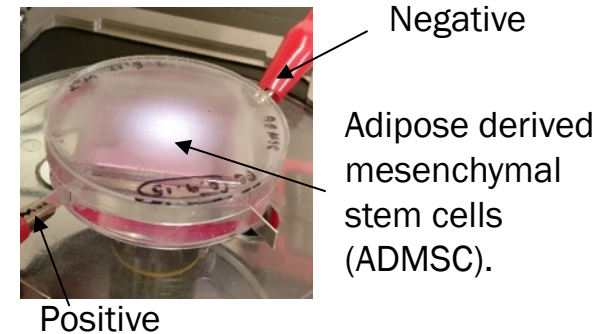
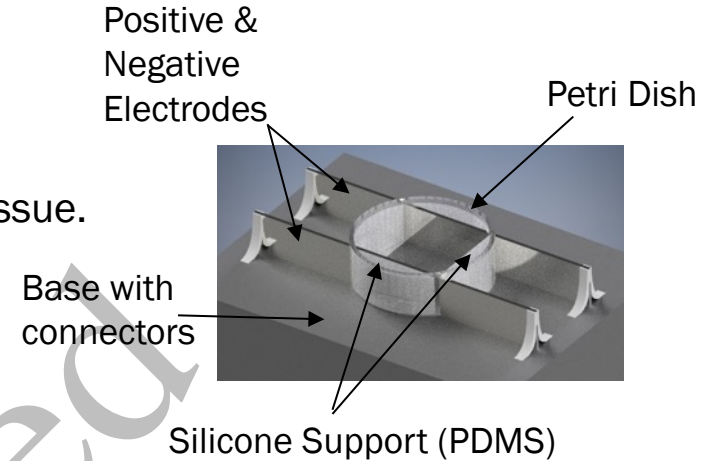
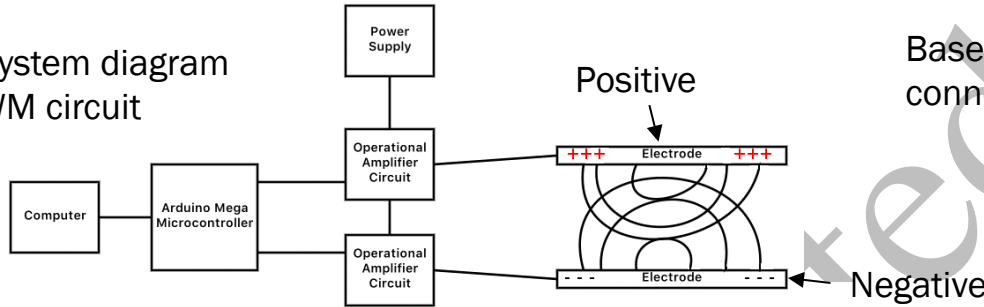

## Average distance and direction cells have travelled.

Cells are pulled towards the +electrode.

Control: 10 minutes, inactive electrodes  
 Test: 10 minutes activated electrodes

Angle of movement may be due to electrodes alignment with camera.

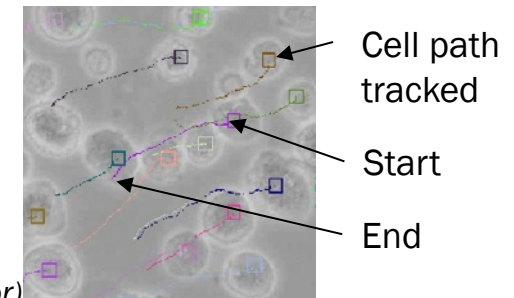
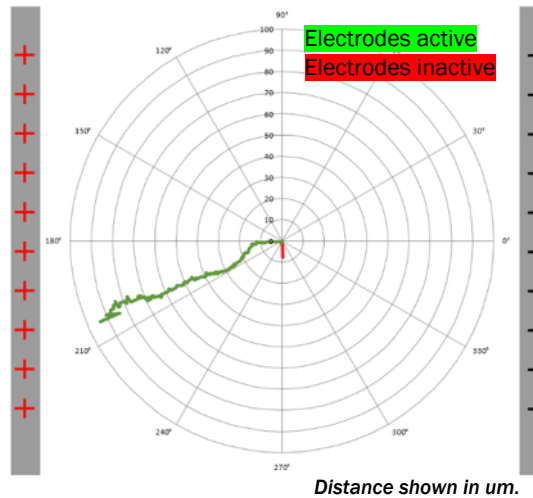



# Non Thermal Irreversible Electroporation (NTIRE)

- Irreversible electroporation (IRE) or Non-thermal irreversible electroporation (NTIRE) is a soft tissue ablation technique using pulsed or exponentially decaying electrical fields to create permanent and hence lethal nanopores in the cell membrane, to disrupt the cellular homeostasis.

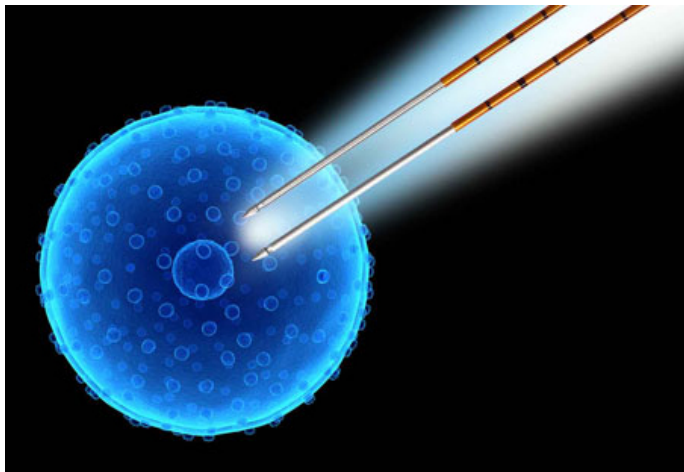

Unlike thermal ablation techniques, NTIRE preserves the extracellular matrix

# Electroporation Example

## Introduction of DNA into Mouse Embryo

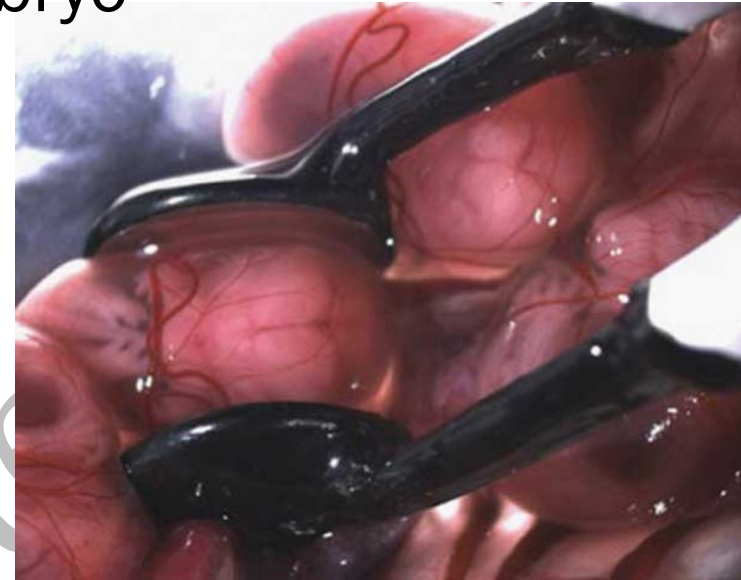

- 3mm diameter disk electrodes
- 5 pulses of 50ms duration
- 950ms interval, i.e. 5% duty cycle
- Amplitudes of the pulses (assuming ideal pluses)
  - 22V, 30V, 40V and 45V – 40 and 45V optimal

*Ref. Electroporation Methods in Neuroscience*  
*Tetsuichiro Saito, pp. 1-13*  
*Springer Science 2015*

## Current Bangor University/Creo Medical work on Non-Reversible EP

Pulse generator with 1ns to 100ns variable pulse width  
 Single pulse or variable duty cycle from 0.5% to 50%  
 Pulse amplitude up to 10KV  
 For cell neutralization – Glioblastoma and Medulloblastoma

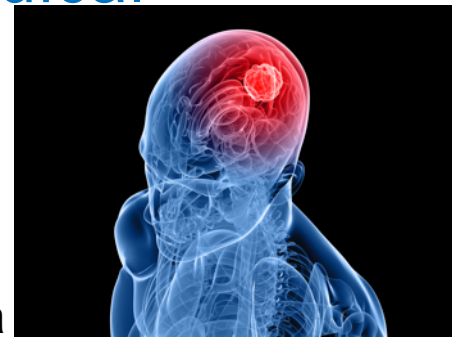



# Conclusions

- Advanced Thermal and Non-thermal energy based therapeutic systems that use RF, Microwave and mm-Wave frequencies can be used to address a number of totally unmet clinical needs or offer a treatment solution that leads to a better overall clinical outcome
- Non-invasive or minimally invasive therapeutic energy delivery, using devices inserted through small incisions (laparoscopes) or natural orifices (endoscopes), has been shown to provide better patient outcome, reduced risk of infection compared to open surgical techniques and faster recovery
- Controlled focused energy delivery into biological tissue structures allows advanced clinical procedures, such as: NOTES, POEMs, ESDs, etc to be adopted
- None of this is possible without continued research and development into new higher frequency, higher power density, higher efficiency microwave and mm-wave devices/amplifier designs and faster signal processing
- **8.8 million people worldwide died from cancer in 2015** –this is nearly 1 in 6 of all global deaths (WHO). There is a growing need for advanced energy based therapeutic systems to enable new clinical techniques to be adopted

The authors acknowledge funding from the European Union's Horizon 2020 research and innovation programme under grant agreement No 737164

Thank you for your attention

Questions