

Grant Agreement No: 101094300

MuCoL

A Design Study for a Muon Collider complex at 10 TeV centre of mass
Horizon Europe Framework Programme

DELIVERABLE REPORT

PRESENTATION OF COOLING CELL CONCEPTUAL DESIGN

DELIVERABLE: D8.1

Document identifier:	MuCol_D8-1_Presentation-Cooling-Cell_final.pdf
DOI:	10.5281/zenodo.11402737
Due date of milestone:	31/05/2024 (End of Month 15)
Work package:	WP8 - Cooling Cell Integration
Lead beneficiary:	UMIL
Report release date:	31/05/2024
Document version:	1.0
Document status:	Final

Abstract:

This report summarises the considerations behind the choice of the type of cooling cell that will be designed within the framework of WP8 of MuCol. After a short introduction to the problem and a description of the results of previous studies, the main choices for the MuCol/IMCC design are described.

MuCol Consortium, 2024

For more information on MuCol, its partners and contributors please see <https://mucol.web.cern.ch/>

Funded by the European Union (EU). Views and opinions expressed are however those of the author(s) only and do not necessarily reflect those of the EU or European Research Executive Agency (REA). Neither the EU nor the REA can be held responsible for them.

Delivery Slip

	Name	Partner	Date
Authored by	R. Losito	CERN	25/05/2024
	R. Taylor	CERN	
	D. Schulte	CERN	
	A. Grudiev	CERN	
	C. Barbagallo	CERN	
	C. Marchand	CEA	
	J. Plouin	CEA	
	G. Burt	UWAR	
	L. Bottura	CERN	
	S. Fabbri	CERN	
	J.A. Ferreira Somoza	CERN	
	R. Franqueira Ximenes	CERN	
	L. Rossi	UMIL	
	D. Giove	INFN	
	G. Scarantino	INFN	
	M. Statera	INFN	
M. Castoldi	INFN		
M. Sorbi	UMIL		
C. Rogers	STFC-UKRI		
R. Zhu	IMP		
J.S. Berg	BNL		
Edited by	R. Taylor	CERN	29/05/2024
	M. Lancellotti	CERN	
Reviewed by	L. Rossi [Task and WP coordinator]	UMIL	30/05/2024
	R. Losito [WP co-coordinator]	CERN	
	D. Schulte [Scientific coordinator]	CERN	
Approved by	D. Schulte [Scientific coordinator]	CERN	31/05/2024

TABLE OF CONTENTS

1. INTRODUCTION.....	4
2. MUON PRODUCTION AND COOLING.....	5
2.1. THE TENTATIVE LAYOUT OF THE MUON PRODUCTION AND COOLING SECTION	5
3. TECHNICAL CONSIDERATIONS ON THE COOLING CELL.....	7
3.1. COMPONENTS OF A COOLING CELL.....	7
3.1.1. <i>Absorbers</i>	7
3.1.2. <i>Solenoids</i>	8
3.1.3. <i>RF Structures</i>	8
3.1.4. <i>RF Power sources</i>	9
3.2. VARIETY OF COOLING CELLS.....	11
3.2.1. <i>Design of a Cooling cell of type S5</i>	12
4. THE MAGNET SYSTEM OF THE RFMF TEST FACILITY AS GUIDELINE DESIGN FOR THE COOLING CELL	18
4.1. COIL DESIGN	19
5. CONCLUSION	21
6. REFERENCES.....	22

1. INTRODUCTION

MuCol aims to advance the design of a Muon Collider Complex, to clarify the parameters of the entire complex of accelerators and to propose new designs for the most challenging components. WP8 in particular focuses on the design and integration of the Cooling Cell (CC). The purpose of a cooling cell is to reduce the transverse emittance of the muon beam. The muon beam is generated by the collision of a proton beam with a production target, which results in a shower of pions that will then decay into muons. These muons are generated with a large angular spread and a large momentum spread. The capture and cooling section will maximize the number of particles captured, and reduce their transverse momentum through interactions with a low-Z material, which will reduce both the longitudinal and the transverse momentum. A Radio-Frequency (RF) cavity will re-accelerate the particles to restore their longitudinal momentum. Through this, the beam is cooled, meaning the particles decrease their transverse energy and their energy spread with respect to the reference energy. Strong superconducting solenoids are present throughout the beam trajectory to maintain its focus around the reference trajectory, limiting the transverse beam size. The cooling performance is critical for the luminosity of the collider, which is one of the key performance indicators of the whole machine.

A preliminary layout is based on a series of cells with RF cavities resonating at 352 MHz in the first section, and at 704 MHz in the rest of the cooling section (see Table 1). This layout is based on the previous work of the US – MAP (Muon Accelerator Program) group [1].

The cooling cells (CC) are complex mechanical assemblies consisting of high magnetic fields, large radius superconducting solenoids, various types of absorbers and high electric gradient RF cavities and their ancillaries (tuners, power couplers) operating in magnetic field. These are all tightly integrated in order to reduce any drift space as much as possible. Given the difficulty of such integration it is considered critical to demonstrate that it is possible to efficiently integrate all the components within a realistic layout, without compromising the performance of the CC.

This report provides a conceptual design of the Cooling Cell and the motivations for the selection of one among the different types of cells, in order to proceed with the complete 3D mechanical integration.

2. MUON PRODUCTION AND COOLING

2.1. THE TENTATIVE LAYOUT OF THE MUON PRODUCTION AND COOLING SECTION

The muon production and cooling system comprises of several subsystems. The protons provided by the proton complex intersect a target to produce pions. The target, yielding a high pion flux, is in the bore of a 20 T solenoid to restrain the particle transverse trajectory. The field is rapidly tapered to 1.5 T and then pions and muons traverse a solenoid-focused chicane where high momentum beam impurities are removed, followed by a Beryllium absorber which ranges out remnant low energy protons. The remaining beam passes through a longitudinal drift where any remaining pions decay. The beam is then captured longitudinally. A multi-frequency RF system that captures the beam into 21 bunches is required, owing to the initially large longitudinal beam emittance. Another solenoid chicane system splits the beam by charge species, in preparation for the ionisation cooling system.

The ionisation cooling system comprises of a series of solenoids, which focus the beam onto energy absorbers where the beam momentum is removed. The momentum is restored longitudinally using RF cavities, resulting in a reduction of the beam's emittance (volume in position-momentum space). An initial rectilinear cooling system reduces the beam emittance sufficiently that the many initial bunches can be merged into one single bunch. The beam is then cooled further to the final emittance, using a continuation of the rectilinear cooling system followed by a sequence of high field solenoids operated ultimately with a low momentum (non-relativistic) beam. The beam is finally re-accelerated to relativistic speeds via the pre-accelerator so that it can be delivered to the acceleration system.

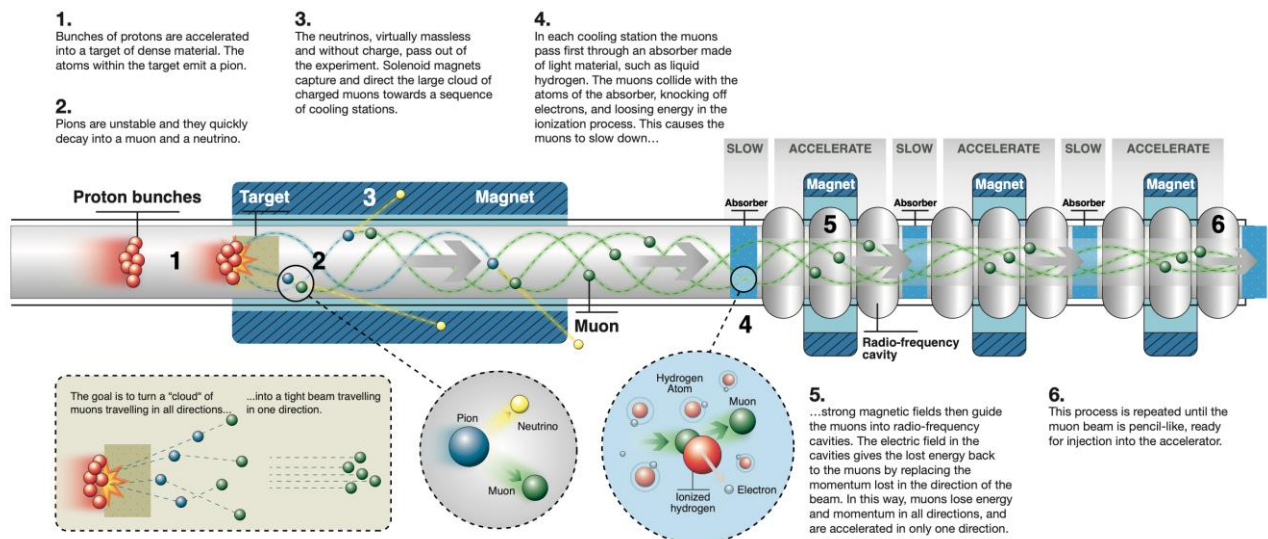

Fig. 1: Conceptual description of Muon Ionisation Cooling [STFC, Ben Gilliland]

Within the two main sections, 6D rectilinear cooling and final cooling, there are about 20 different types of cooling cells. Each of these have various geometry, length, magnetic field strength, electric field (often called gradient) and frequency starting at 352 MHz and continuing with harmonics (704 MHz). In order to decide which one is the more interesting to be designed in detail, one has to look

not only at scientific considerations, but also to practical aspects that would maximise the return on experience for the required investment.

In order to focus the effort, one has to identify the main goals of the design exercise. We have therefore listed the main motivations to design and, in the future, build and test a cooling cell:

- Previous studies on Muon Colliders have never gone through a thorough exercise of 3D mechanical integration of the components (RF, magnets, absorber). Given the fact that the performance required is very demanding for each of the components, it is important to be able to provide a very compact design, minimizing the drift spaces that reduce the real estate gradients, i.e. the average electric field over the whole cavity length. It is therefore important to understand how much the technical systems (water cooling, power feeds, cryostat and cryogenic cooling etc.) impact the compactness of the assembly.
- Concerning the *magnets*, the last technology programme for the Muon Collider (US-MAP) ended in 2016. Since then, High Temperature Superconductors (HTS) became more affordable and more reliable, allowing reasonably higher fields at a relatively low cost. For this reason, we chose to use HTS (High Temperature Superconductors) in form of REBCO tapes as superconductor to wind the solenoids of the cooling cells, rather than Nb₃Sn as in the US-MAP design. Although REBCO has been tested in a few prototypes to produce even higher fields than those required for ionization cooling (20T and more), there is still little experience in Europe and in particular in the accelerator community. Therefore, it is necessary to foresee the design of a magnet that is not too challenging yet not too easy. A solenoid generating a field between 5T and 10T on its axis is significant if it can be subjected to extensive testing. In addition, it is worth noticing that the solenoids, profiting of the main property of HTS (i.e., the high critical temperature) will be designed to operate at 20 K, by use of cryocoolers. The choice to go for higher temperature in the cooling cell is a novelty introduced in the IMCC/MuCol design study mainly driven by energy saving and sustainability considerations, as helium is becoming rarer. We believe that for the muon collider and any other future large accelerator for the post-LHC era, it is fundamental to confirm that such a high operational magnet temperature concept is feasible.
- For the *RF structure* there are still many open questions. The role of RF in ionisation cooling is to transfer longitudinal momentum to muons in the fastest possible way. This means in practice that we must provide the highest possible voltage, with a reasonable value for the real estate RF gradient up to around 40 MV/m at 704 MHz. Here, real estate RF gradient is defined as the total RF voltage, divided by the length of the cooling cell, therefore including eventual drift space and the absorber. Such value is limited by the power that would have to be fed into the cavity, and to limit field emissions at high field. Open topics includes the cell-to-cell coupling, the mode of resonance, the number of power couplers, the space necessary for the couplers and the other ancillaries, such as the availability of a klystron etc.
- Regarding the *absorbers*, the best performance would be provided by liquid Hydrogen. There are unfortunately a number of drawbacks, such as the peak of overpressure that would be instantly generated by the energy peak deposited by the beam passing inside the liquid and the fact that hydrogen is highly flammable. Therefore specific safety measures have to be studied and the hazards must be well understood before being able to commit on such solution. Lithium Hydride is also a candidate material, providing a degradation in performances yet to be quantified, but since it is in solid phase and with limited safety hazards, it is considered a good choice for the first 3D integration exercise.

- Several ancillary issues have to be looked at, for instance the effect of the solenoids of adjacent cells, to understand whether they increase the peak field on each coil or the stress on the mechanical parts of the cell under consideration. It has to be understood whether it is worth including the solenoids of the adjacent cells in the design of a single cooling cell, how to deal with the magnetic forces that will be generated in order to start analyzing the powering schemes, the necessary protections, and the most convenient cryostat configuration. The assembly scenario is also part of this exercise, to discuss what is the best assembly sequence, intervention scenarios following eventual failures, analysis of the most credible incident scenario etc.

Within the framework of MuCol, a workshop was organized in January 2024 [2] to collect information from various experts and members of both MuCol and the International Muon Collider Collaboration (IMCC), and more discussions were organized at the MuCol and IMCC annual meeting [3]. A consensus was found around the design of a Cooling Cell of the type B5 (named from the previous MAP configuration), also referred to as S5 in the new naming convention recently. This Cell would be simplified to two solenoids, a multicell RF structure and an absorber of LiH. These different components will be described in the following paragraph.

3. TECHNICAL CONSIDERATIONS ON THE COOLING CELL

3.1. COMPONENTS OF A COOLING CELL

A cooling cell is composed of two or more solenoids, an RF Structure made of one or multiple RF cells, and one or two absorbers made of low-Z materials.

The Collaboration adopts the terminology in Fig. 2 to designate the elements of a cooling cell.

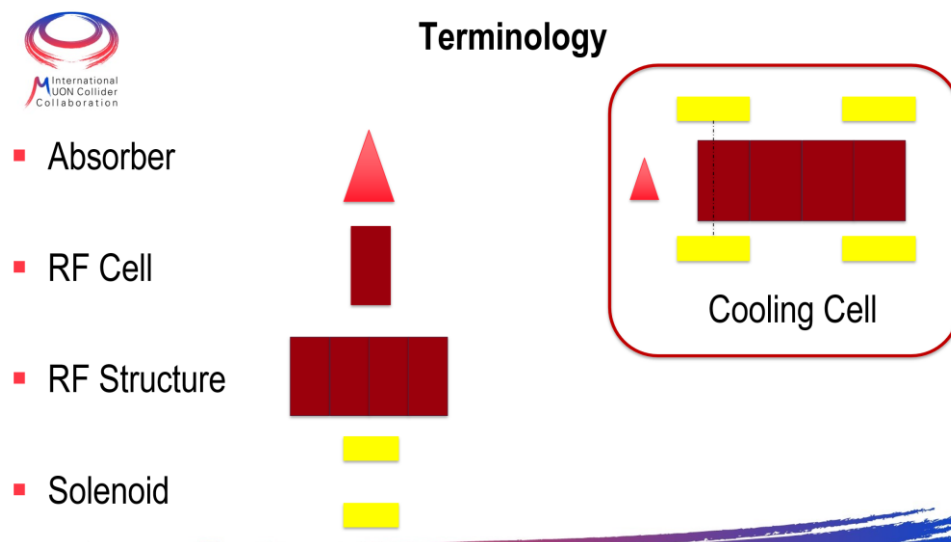

Fig. 2: Terminology for the cooling cell. It is important to underline that in this convention RF Structure and RF Cavity are synonyms. The two solenoids of a cooling cell are indicated as either a solenoid pair or a split coil.

3.1.1. Absorbers

Several low-Z materials have been considered for the absorbers, with two options preferred over the others:

- **Liquid Hydrogen:** the best from the point of view of the performances, minimising the loss of particles in the absorber and still providing sufficient absorption of the momentum of the particles.
- **Lithium Hydride:** Easier to use since it is solid at room temperature, presents no hazards, and is relatively easy to machine, however provides a lower effective yield.

For the practical reason mentioned in section 2.1 for this first exercise of preliminary design we have selected the LiH absorber.

3.1.2. Solenoids

Cells are being designed with just two solenoids, one at each end of the cooling cell. Simulations of beam dynamics in the cooling section are still in progress, and it is possible that in order to improve the performance, some cells might have to include more solenoids (i.e. 4, 6 or more, as shown in Fig. 5 of [1]). For the purpose of performing the first exercise of design and integration of a cooling cell, we will consider only a cell design based on two solenoids. The design of Muon Collider solenoids is based on the technology of High Temperature Superconductors (HTS) compared to Low Temperature Superconductors for several reasons:

- higher critical field,
- better critical current in high Magnetic fields,
- higher operational temperature leading to:
 - the possibility of operating at 20 K (increasing the thermodynamic CoP by a factor 10 with respect to the 2K used for LHC Nb-Ti magnets and for HL-LHC Nb₃Sn magnets) and US-MAP,
 - increased temperature and energy margin to quench. Though a protection system will be necessary, for safety reasons, we believe that after a very reduced initial training, a HTS solenoid will be quench-free in operation thanks to the larger margins in both critical field and critical temperature of the material.
- Minimisation of operational costs and maintenance time (no use of LHe or HEII).

The IMCC collaboration is therefore working on the hypothesis that all magnets for the cooling sections of the future Muon Collider will be based on HTS, in particular on REBCO tapes. It is assumed that by having just one type of superconductor, or one family of superconductors, economy of scale will bring an overall cost reduction for the production of the REBCO tapes. On this material there is also a very interesting synergy with the world of nuclear fusion as they have chosen REBCO as the material for future fusion projects, which will bring additional economies of scale, and will provide opportunities for the exchange of knowledge that will benefit both communities.

3.1.3. RF Structures

A decision on the type of RF structure that will have to be integrated in the cell requires taking into account a number of parameters which includes:

- the required real estate gradient in a cell vs. the peak gradient achievable in the RF structure,
- the available or realistically feasible power sources,
- the space available to fit ancillaries (e.g. tuners, power couplers, cooling pipes etc...), considering the tight interference with the cryomagnetic system,

- the type of RF coupling from cell to cell,
- the RF frequency,
- expected breakdown rate and eventual mitigation strategy, especially in the high magnetic field and high magnetic gradient they experience.

The most important decision to be taken is whether or not the mechanical design foresees the thin windows simulated in the beam physics scenario. Such windows will make the mechanical assembly extremely complex, and the use of beryllium requires special safety measures that one should avoid if possible. Aluminium could be an alternative, with some loss of performance. Moreover, the use of windows obliges to foresee openings on the RF cell to be able to couple the RF power from cell to cell, bringing a further complication. Conversely, not having the windows dramatically simplifies the RF and mechanical design, at the expense of a loss of performance in the cooling line, that has yet to be assessed.

It is worth noting that most of the parameters used for simulations of the entire cooling section are at the edge (and sometimes beyond) the present state-of-the-art, therefore a careful evaluation of the feasibility of the corresponding technological solution is required, leading, in the worst case, to a limitation that will affect the efficiency of the entire cooling line. This is a strong motivation to design a structure in a frequency range where power sources exist, to equip a test stand where one could push such an RF structure to the limits of its performance. In the following paragraph we will analyse the availability of RF sources and provide a justification for the choice of the frequency to be used for the design.

3.1.4. RF Power sources

A test stand will be designed which is devoted to test the technological feasibility of the elements discussed above. The requirement is that the test stand must match the challenging parameters of the cooling cell simulations, and has to deal with the RF power required for the involved cavities.

Considering the reference frequency of 704 MHz, designs and simulations for a simple pill-box cavity demonstrates the possibility to reach accelerating fields of the order of tens of MV/m. This results in a RF power requirement of 5 MW, considering a pulsed feeding scheme with a few microseconds pulse length. The simplest cooling cell design deals with at least 15 MW.

The picture reported in Fig. 2 represents a scheme of the available RF sources in terms of frequencies and related power limits. The zone of interests for Muon Collider requirements (top left) emphasizes the low density of available elements. Whilst tubes >24 MW exist, they are all above 3 GHz.

Within the acceptable MC area, we quote the Klystron adopted for 352 MHz RFQ/DTL cavities for ESS (Thales 2179), which provides a power up to 2.8 MW and also the Klystrons for 704 MHz MB/HB cavities (CPI VKP-8292A and Canon E37504) which reach 1.5 MW. Use of these Klystron types will entail a design with 2 devices for each cell.

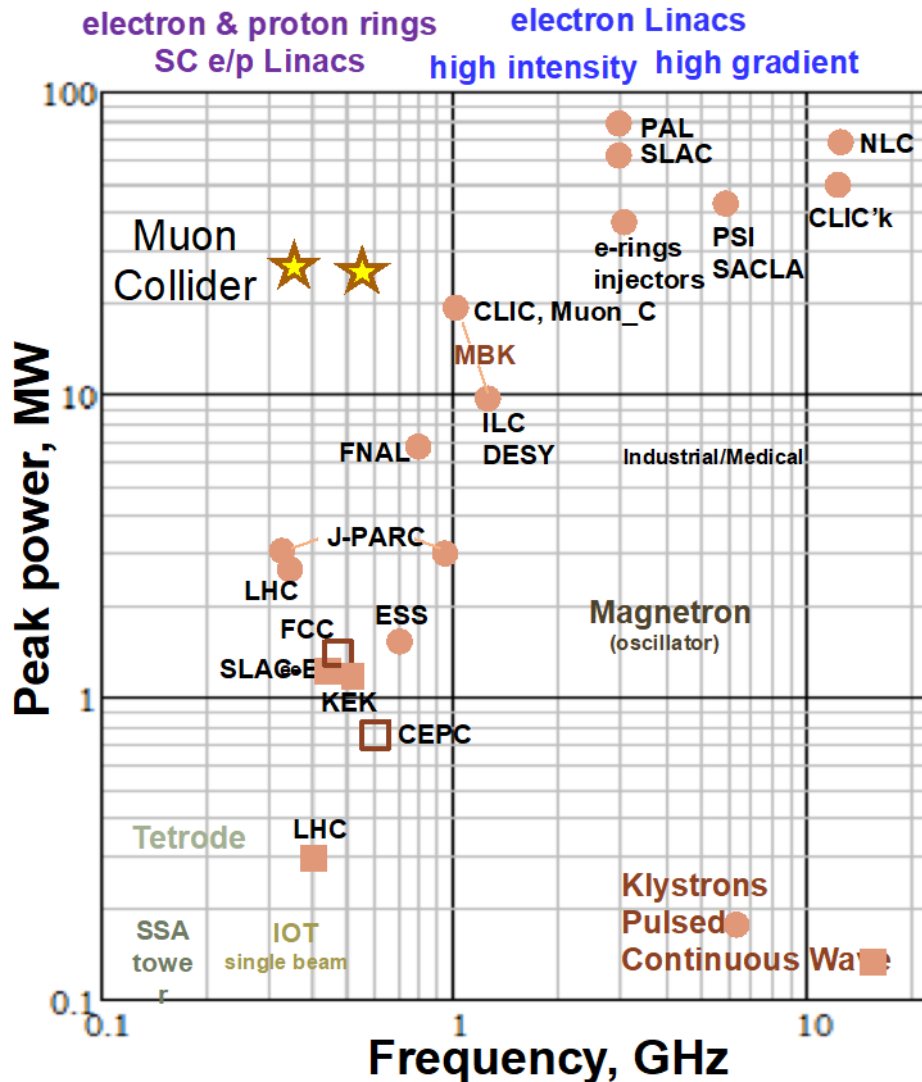

Fig. 2: Available power source at various frequency, ordered by peak power.

There are 10-20 MW tubes developed for CLIC drive beam and ILC at 1-1.3 GHz.

Nothing of this power exists at lower frequencies. The issue is typically that to get high power, high voltage is required, which makes the tubes longer. The scaling at low frequency is not feasible as length is inversely proportional to frequency for constant beams.

New developments may change this scenario, but this may require investments and developments of a time scale longer than that required to design and put into operation a test bench.

The Klystrons at 1 GHz of particular interest are the Canon E37503 and Thales TH1803 Klystrons (peak power of 20 MW and efficiency of 70%), successfully used in the drive beam acceleration for CLIC. These sources are still available and at CERN there is experience on the RF chain that integrates them. The increase in frequency with respect to the reference 704 MHz figure may be considered limited, which is counterbalanced by the possibility of putting into operation a power station, within a few years.

This evidence suggests that we proceed with a full cooling cell design based on 704 MHz coupled cavities, and provide a full mechanical layout of the facility to verify the compatibility of the solution and, in parallel, to scale this design considering 1 GHz cavities for a full power test stand.

3.2. VARIETY OF COOLING CELLS

The layout of the muon production system is shown in Fig. 1. While there is a rich history of different sorts of muon beams cooling systems, the IMCC has only rectilinear and final cooling systems for the facility design, with the rectilinear cooling system selected for the cooling cell.

The rectilinear cooling system is comprised of many highly compact cooling cells, containing a mix of high gradient RF cavities and relatively high field superconducting solenoids. Two systems are required, one for each charge species, with each planned to be about 1 km in length. Each system is divided into two sections, distinguished by the cell tune (number of betatron oscillations) per cell. The initial cooling is performed by ‘Type A’ cooling cells that operate with a cell tune below 1. This operating point is chosen as the lattice can accept a beam with a higher emittance, suitable for the initial beam arising from the capture system.

The bunches are then merged before being cooled in ‘Type B’ cooling cells that operate with a cell tune between 1 and 2. Operating at a higher tune causes cooling cells to have tighter focusing, and so yield lower emittances. The cost of this is that the cooling cells do not accept such high emittances, and in particular have a limited momentum acceptance owing to stopbands at the integer resonances.

Proposed parameters, under review by IMCC, are shown in Table 1. The earlier stages have weaker solenoidal (Bz) magnetic fields and longer cooling cells, while the later stages have stronger fields. WP7 is reviewing the limits of achievable solenoid field. This design employs liquid hydrogen absorbers. The heat load on these absorbers, especially when the beam is narrow in the later stages, may cause undesirable effects in the hydrogen, necessitating the use of lithium hydride absorbers. In these cells the RF cavities are assumed to be independently phased; this would require a complicated power feed. Alignment and beam instrumentation systems have not been studied and presently there is little space to enable installation of such a system.

Table 1: Parameters under consideration by IMCC for the rectilinear cooling system.

	Cell length (m)	Stage length (m)	Pipe radius (cm)	Max. on-axis B_z (T)	Integrated B_y (T·m)	Transverse beta (cm)	Dispersion (mm)	On-axis wedge length (cm)	Wedge apex angle (deg)	RF frequency (MHz)	Number of RFs	RF length (cm)	Max. RF gradient (MV/m)	RF phase (deg)
A-Stage 1	1.8	104.4	28	2.5	0.102	70	-60	14.5	45	352	6	19	25.8	18.5
A-Stage 2	1.2	106.8	16	3.7	0.147	45	-57	10.5	60	352	4	19	25.8	23.2
A-Stage 3	0.8	64.8	10	5.7	0.154	30	-40	15	100	704	5	9.5	31.4	23.7
A-Stage 4	0.7	86.8	8	7.2	0.186	23	-30	6.5	70	704	4	9.5	31.7	25.7
B-Stage 1	2.3	55.2	23	3.1	0.106	35	-51.8	37	110	352	6	25	21.01	28.22
B-Stage 2	1.8	61.2	19	3.9	0.138	30	-52.4	32	120	352	5	22	22.68	30.91
B-Stage 3	1.4	77	12.5	5.1	0.144	20	-40.6	24	115	352	4	19	24.27	29.76
B-Stage 4	1.1	70.4	9.5	6.6	0.163	15	-35.1	20	110	352	3	22	25.03	29.48
B-Stage 5	0.8	53.6	6	9.1	0.116	10	-17.7	12	120	704	5	9.5	23.46	23.81
B-Stage 6	0.7	49	4.5	11.5	0.0868	6	-10.6	11	130	704	4	9.5	30.48	19.65
B-Stage 7	0.7	34.3	3.7	13	0.0882	5	-9.8	10	130	704	4	9.5	31.29	17.41
B-Stage 8	0.65	47.45	2.65	15.8	0.0726	3.8	-7.0	7	140	704	4	9.5	26.87	14.37
B-Stage 9	0.65	35.1	2.25	16.6	0.0694	3	-6.1	7.5	140	704	4	9.5	27.67	19.42
B-Stage 10	0.632	43.59	2.1	17.2	0.0691	2.7	-5.7	7	140	704	4	9.5	17.61	16.39

The ‘Type B’ cells have been initially chosen for more detailed study as they are physically and optically more demanding. Optically they require a careful balance between focusing strength, control over the location of the stopbands, and acceptance. The RF and absorbers must be carefully controlled to ensure that the RF does not accelerate particles into the stopbands while maintaining sufficient acceptance to control the beam. The B5 cell provides a good balance of demanding magnets, high acceptance and low emittance.

3.2.1. Design of a Cooling cell of type S5

A cooling cell has been designed based on the design for the B5 cell described above, but takes several approaches which may facilitate the cell construction, at the expense of a higher peak magnetic field. An optimisation to find the best compromise shall have to be part of the design process. The cooling cell schematic, as simulated in G4Beamline, is shown below. The lattice was simulated using G4Beamline v3.08 [4]. Parameters for the cooling cell are described in Table 2 while a schematic is shown in Fig.3

In order to generate the simulation, a solenoid lattice was generated using an ideal solenoid field based on a sum of harmonic components. This ideal field, described as the “Design solenoid parameters” was used to calculate optical functions in order to estimate cooling performance. A coil geometry was generated in order to calculate a 3D field map which could be used for tracking in G4Beamline. Dipoles were added, enabling calculation of dispersion. The dipoles were treated as a vertical field that filled the transverse aperture of the beam pipe and had a hard edge that did not reflect a realistic fringe field; subsequent iterations of the design may include a realistic fringe field model when a dipole arrangement becomes known.

RF cavities and absorbers were added in order to estimate the energy change and ultimately the cooling performance. The RF cavities were treated as ideal cylindrical TM010-mode pillboxes with an electric field that was uniform longitudinally and a Bessel function transversely. A matching magnetic field, out of phase with the electric field, was also included in the simulation. The RF cell length and spacing was chosen so that a 200 MeV/c muon would pass between the midpoint of cells in one half of an RF oscillation. Thin windows were used to terminate the RF cavities, which had the

effect of increasing the available accelerating gradient at the expense of introducing scattering and potentially degrading the cooling performance. For this reason, thin windows were used to minimise scattering. Such windows complicate both the electromagnetic and mechanical design of the RF structure, therefore during the design process several different configurations will be simulated in order to find an optimum among cell performance on complication of design.

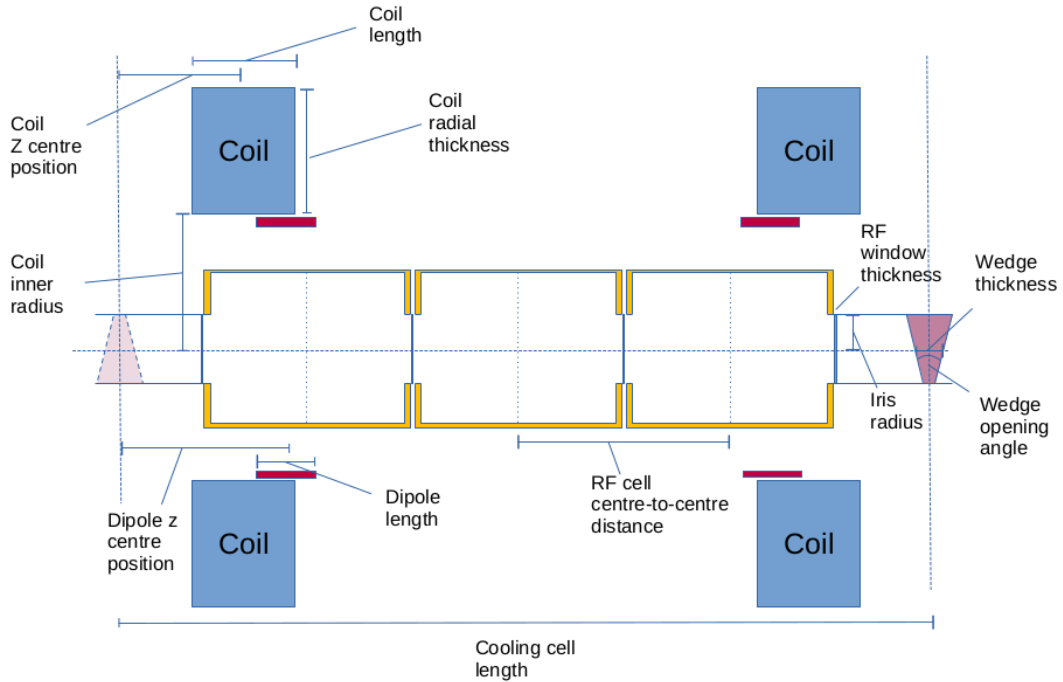

Fig. 3. Schematic of a Cooling Cell with reference parameters for RF, Magnets and absorber.

Table 2 Reference parameter values used for the preliminary calculation of the cooling cell S5 (R5)

Cooling Cell Parameters	
Beam Physics Parameters	
Momentum	200 MeV/c
Twiss beta function	107 mm
Dispersion in x	38.5 mm
Dispersion in y	20.3 mm
Beam pipe radius	81.6 mm
Design solenoid parameters*	
B0.5	0 T
B0	8.75 T
B1	1.25 T
B2	0 T
Cooling Cell length	800 mm
B0 tolerance	0.25 T
B1 tolerance	0.025 T
B0.5 tolerance	0.02 T
B2 tolerance	0.5 T
Simulated coil geometry	
Coil inner radius	250 mm
Coil length	140 mm
Coil radial thickness	169.3 mm
Coil z centre position	100.7 mm
Current Density	500 A/mm ²
RF Cavity**	
RF cell centre-to-centre distance	188.6 mm
RF Gradient, E0	30 MV/m
Iris radius	81.6 mm
Number of RF cells	3
Frequency, f	0.704 GHz
Synchronous phase	20 degree
RF window thickness	0.1 mm
Wedge	
Material	Lithium Hydride
Wedge opening angle	10 degree
Wedge thickness	20 mm
Wedge alignment	Horizontal
Dipole	
Dipole length	100 mm
Polarity	+ - - +
Field	0.2 T
Dipole z centre position	160 mm
Dipole field direction	Vertical

*Solenoid field on axis defined by $B = B_{0.5} \sin(\pi z/L) + B_0 \sin(2\pi z/L) + B_1 \sin(4\pi z/L) + B_2 \sin(6\pi z/L)$

** Field on axis in RF cavity defined by $E = E_0 \sin(2\pi f t + \phi)$; adjacent cavities have ϕ offset by 180 degrees

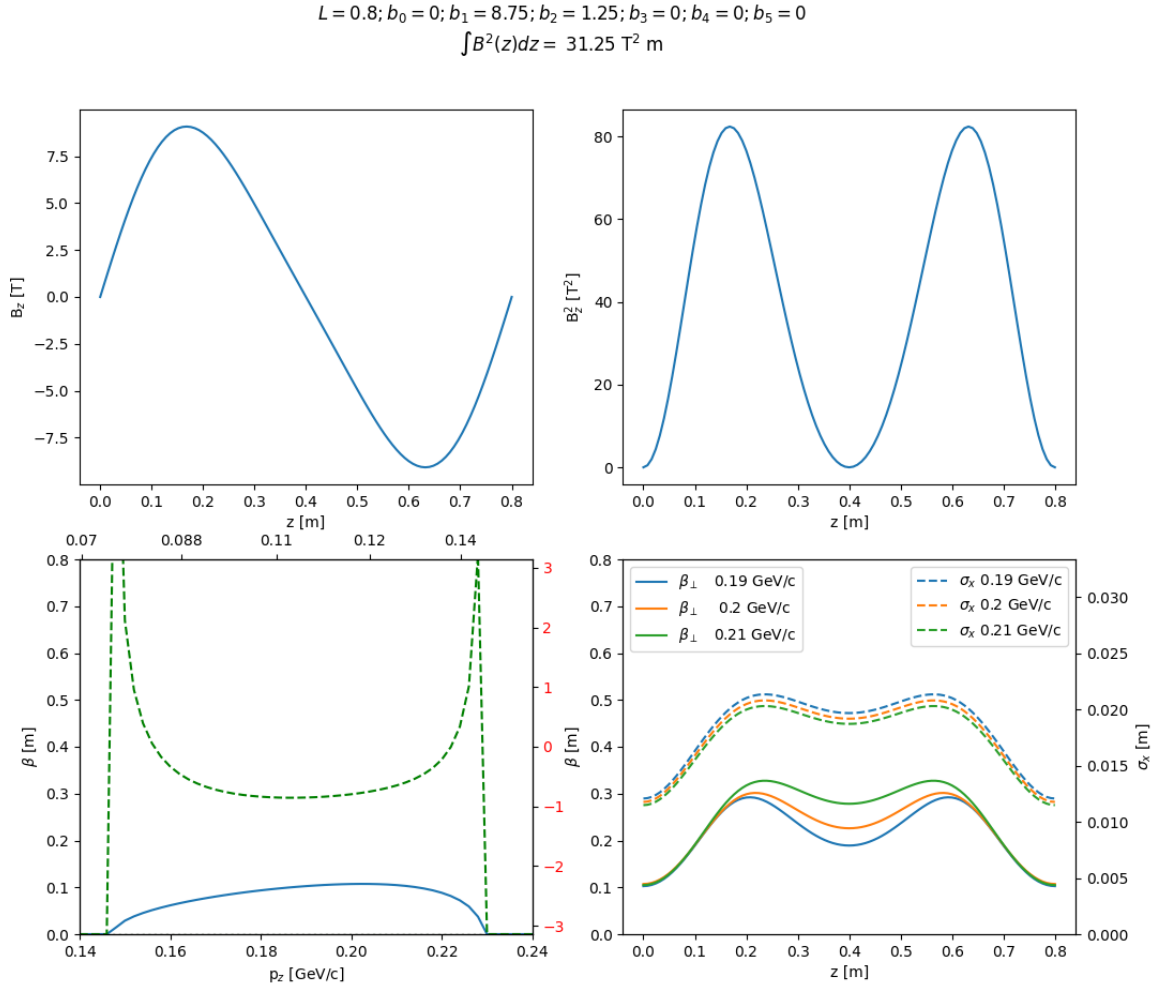

Fig. 4. Magnetic field profile (top) and optical function β -function (bottom), as well as the $1\text{-}\sigma$ beam radius, plotted along the cooling cell.

The ideal solenoid parameters are shown in Fig. 4. The top-left plot shows the on-axis field, while the top-right plot shows the square of the field, proportional to the solenoid focusing strength. The bottom-left plot shows the optical beta function at the focus and anti-focus as a function of momentum in the pass band of interest. The bottom-right plot shows the optical beta function along the cooling cell for a selection of momenta. The beam radius at one standard deviation for a beam of 2.5 mm transverse normalised emittance is also shown. The lattice yields stopbands at around 140 MeV/c and 230 MeV/c, showing the maximum momentum acceptance of the magnetic lattice. The beam size at 1 standard deviation is 11.5 mm at the focus and about twice that at the maximum extent.

The transverse acceptance was calculated by tracking a beam of muons uniformly distributed in x and y actions and angles. The muons were generated at the field flip so the average angular momentum of the beam was set to 0. This process was repeated for a number of different momenta. The resulting survival probability after traversing 80 m was calculated and is shown

in Fig. 5. The solenoids exhibit an octupole-like behaviour that gives excess focusing for high amplitude particles, increasing their tune towards 2. This yields a worse dynamic acceptance for the low momentum particles.

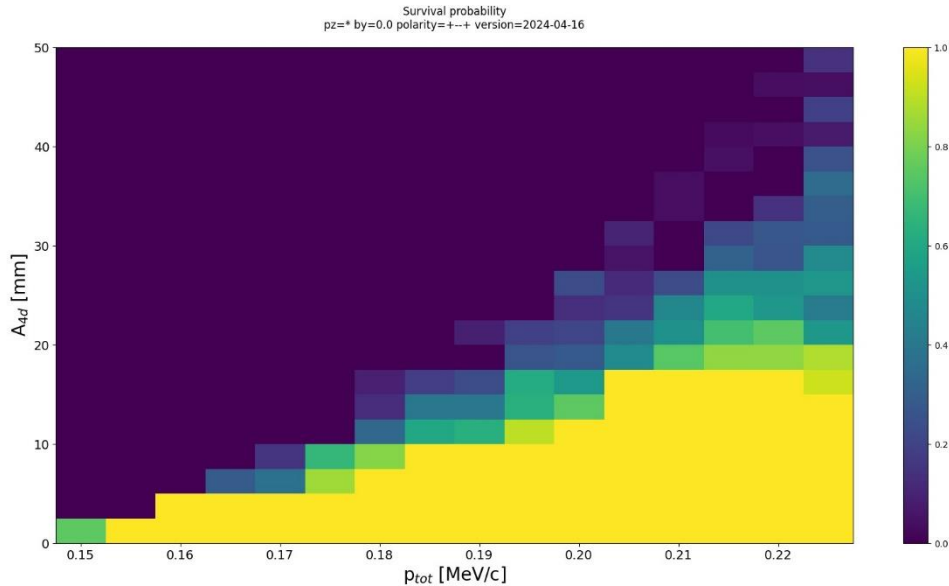

Fig. 5. Muon survival probability (see text for details)

Dispersion was introduced by adding dipole fields to the lattice. By flipping the dipoles in every other cell, significant dispersion can be produced. The dispersion that is produced is shown in Fig. 6.

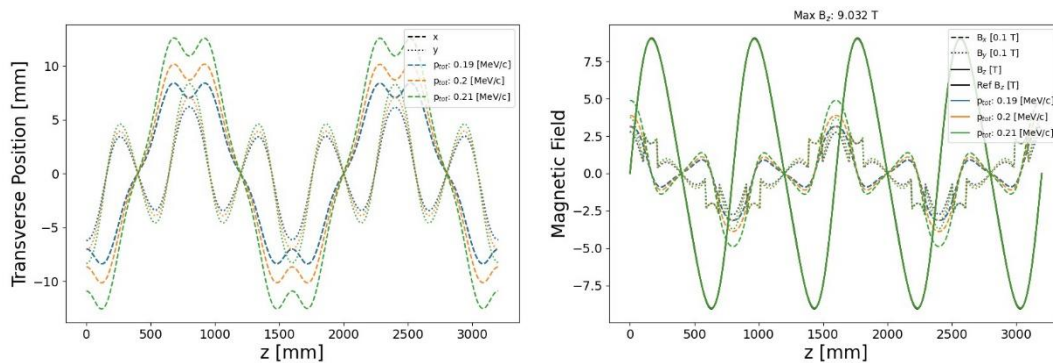

Fig. 6. Effect on transverse position induced by the dispersion and magnetic field various components along the cooling cell (z - direction).

2T dipoles of length 0.1 m were introduced with the dipole field flipping in adjacent cells. The closed orbit distortion that this creates is shown in Fig. 6 (left) and the resultant field along the closed orbit is shown in Fig.6 (right). The dipole field strength was ramped between 0 and 0.2 T to explore the impact on dynamic aperture, calculated in the same way as described above. Negligible reduction in DA was observed.

RF cavities were introduced to the lattice. Three RF cells were simulated in each 0.8 m period of the solenoid lattice. Each RF cell was separated from its neighbour by 188.6 mm long. Adjacent cells were simulated 180 degrees out of phase with respect to each other. This arrangement may enable a single power feed to the central cavity and inductive or capacitive coupling to bring power to the end cells, which is likely to be more practical than individual power feeds to each cell. The RF cavities were modelled with 30 MV/m and 0.704 GHz RF frequency, which is the expected achievable voltage that may be possible for this cooling system, depending on RF tests. A LiH wedge absorber was also introduced and the thickness adjusted so that the RF bucket could comfortably accommodate a beam of 1.3 eV ms (3.7 mm) longitudinal emittance, which was the target longitudinal emittance for this lattice. 20 mm was found to be a suitable wedge thickness on the closed orbit. Time-energy trajectories of some nominal particle tracks are shown in Fig.7, where the energy of the stop bands and contours at 1.3 and 3.9 eV ms RMS emittance are also shown.

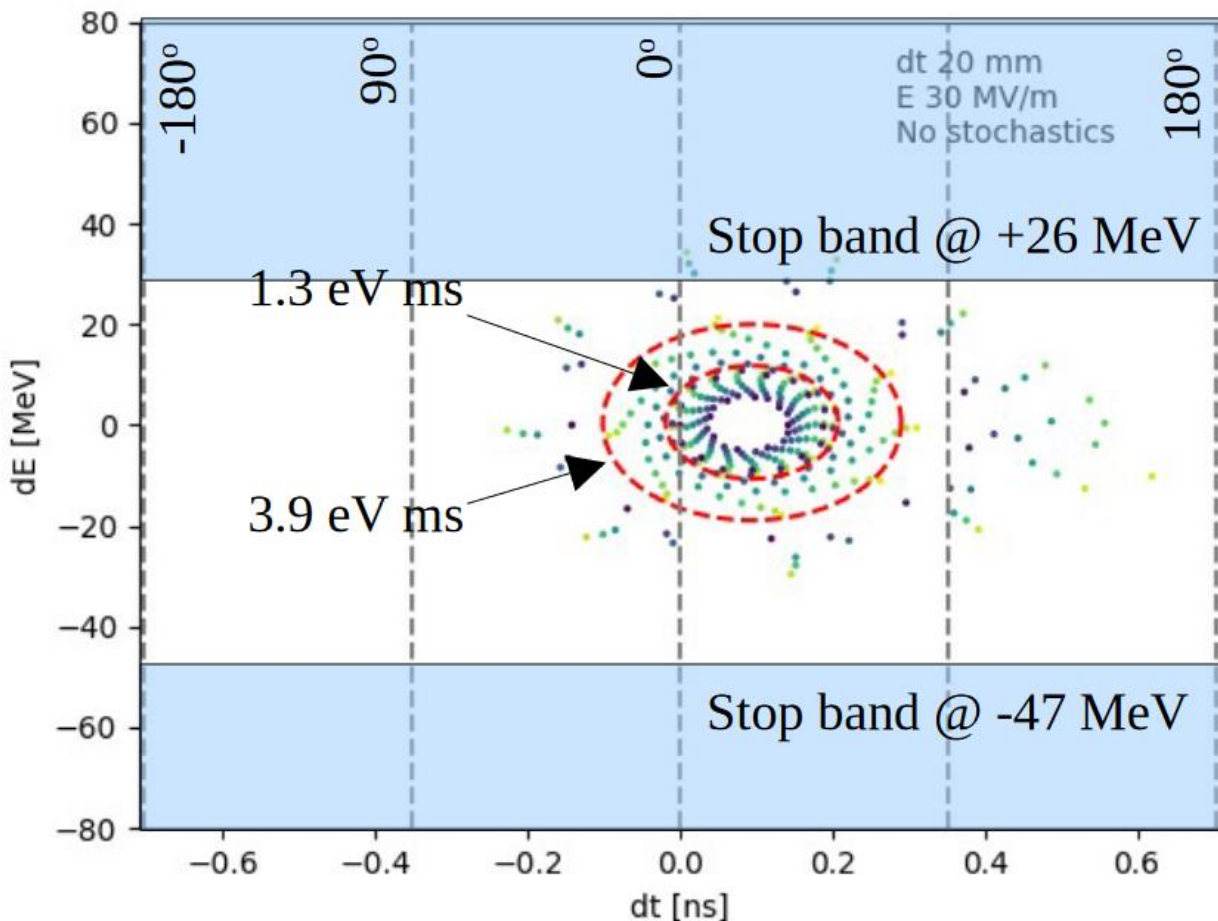

Fig.7. Energy of the stop bands and contours at 1.3 and 3.9 eV ms RMS emittance

Finally the cooling channel was simulated with a full beam. The initial beam was a multivariate gaussian. The performance of the cooling channel is shown in Fig. 8. An over long cooling channel was simulated so that the full range of emittances from injection to equilibrium could be observed. A significant mismatch was observed in longitudinal phase space despite a reasonable attempt at linear

matching, which corresponds to the loss of the tails of the gaussian beam. This was accompanied by beam loss. A beam preparation system will be needed for the cooling demonstrator and is under study. After the initial mismatch, performance is acceptable.

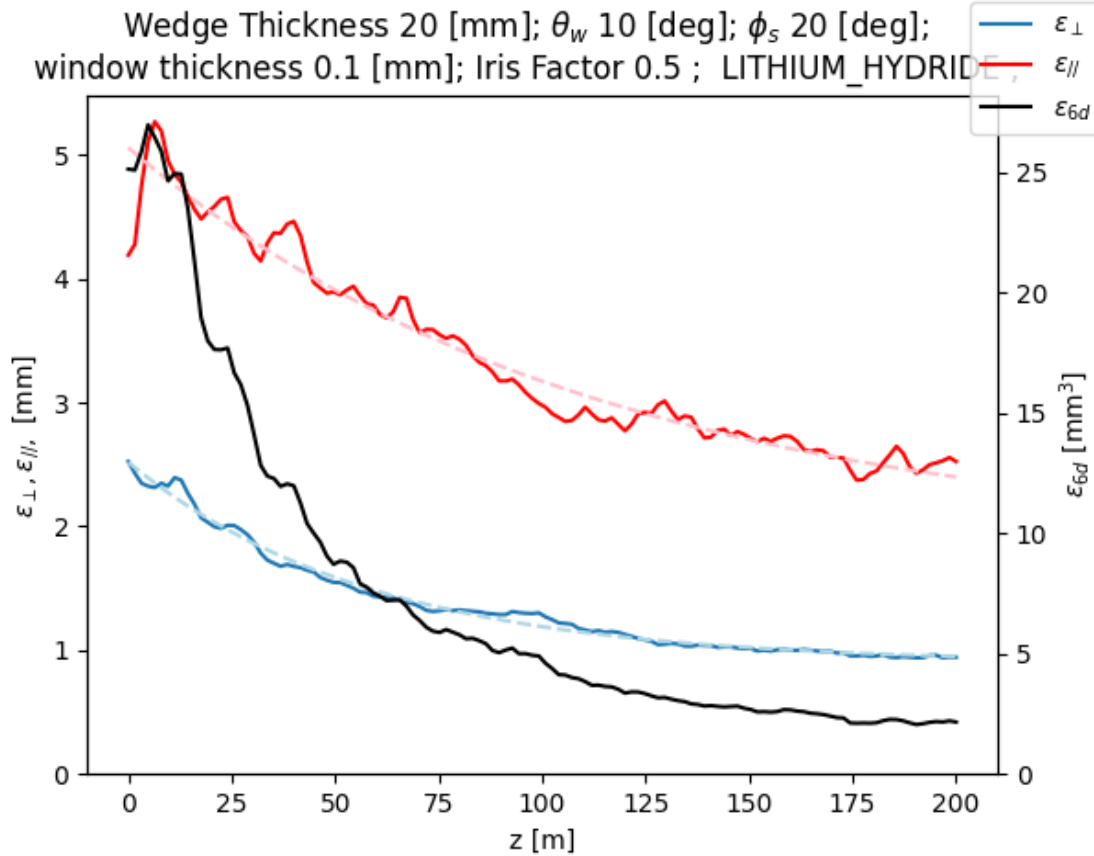

Fig. 8. Main performance indicator: emittance behavior along the cooling cell.

1

4. THE MAGNET SYSTEM OF THE RFMF TEST FACILITY AS GUIDELINE DESIGN FOR THE COOLING CELL

The IMCC collaboration considers the construction of a facility to test single cell RF cavities in high magnetic field as a primary objective of the R&D phase toward a muon collider. Among various options, INFN is proposing to design and build a facility called RFMFTF (Radio Frequency in Magnetic Field Test Facility). The facility consists of a split coil (or coil pair) capable of generating both uniform and gradient magnetic field in order to study the behaviour of various RF structures in magnetic field condition, similar to the one experienced in the cooling cells, see Fig 9. The size of the coil pair is such that will allow testing of room temperature cavities of frequency approximately higher than 1.3 GHz, in magnetic field up to 7 Tesla. In particular the INFN project is, in a first step, aimed at testing 3 GHz RF cavities: in this case the room inside the bore is not an issue and the service can come longitudinally, along the axis of the magnet or beam direction.

An additional goal of the RFMFTF is to be a first and significant prototype of the cooling cell magnet

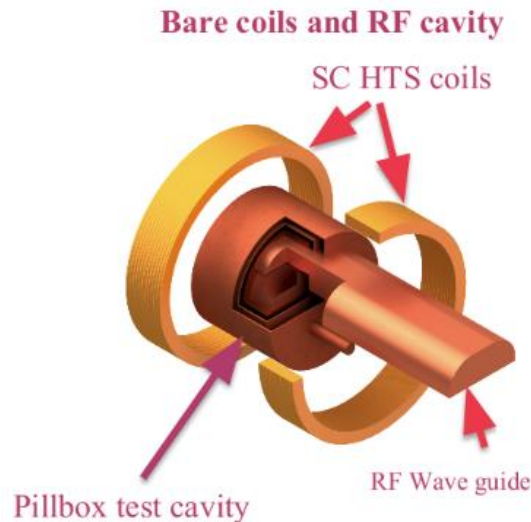

Fig. 9: Sketch of the RFMFTF as proposed by INFN. For a coil radius of 200 m the effective free bore for the RF system is about 300-320 mm

technology. Therefore, even if the field level would allow to use classical Nb-Ti, it will be designed and built in HTS for operation at 20 K. The cooling method is still to be decided. It might be cooled by means of a flow of cold He gas at 20 K, as is most likely for the cooling cell of the Muon Collider, or can be cooled without any cryogenic fluid, by means of cryocooler. In any case the coil will be cooled via solid conduction, i.e., it will be a cryogen-free coil.

Here in this chapter we make a short description of the RFMFTF magnet as a contribution to the preliminary design of the magnet of the cooling cell. The criteria of magnet design of the cooling cell will follow the ones of the RFMFTF.

4.1. COIL DESIGN

Each coil of the pair is composed of six flat pancakes wound with flat HTS tape, see Fig.10 where the structure of the coil is shown with the table of main parameters. Those parameters would allow 7 T field to be generated in a room temperature free bore of 300-320 mm.

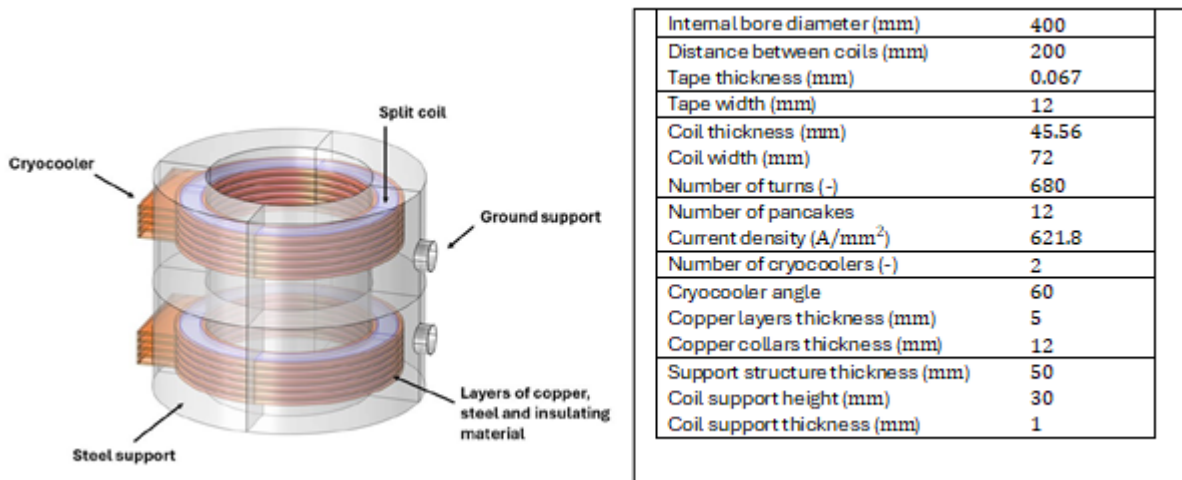

Fig. 10. Left: split coil structure. Right: main parameters list.

The coils are submitted to a large radial force and hoop stress, so they need a robust support of 316 LN austenitic steel, about 50 mm restraining the coils expansion, see Fig. 11. In the same figure it shows that the coils are kept in a unique cold mass that helps to support the strong forces between coils. Because the system is designed both for opposite and same current polarity in the coil (to create a gradient field – like in the cooling cells – or a uniform flat field inside the coils), we have opted for integrating the coils in a unique mechanical structure, abandoning the initial system where two separate coils were supported by tie-rods.

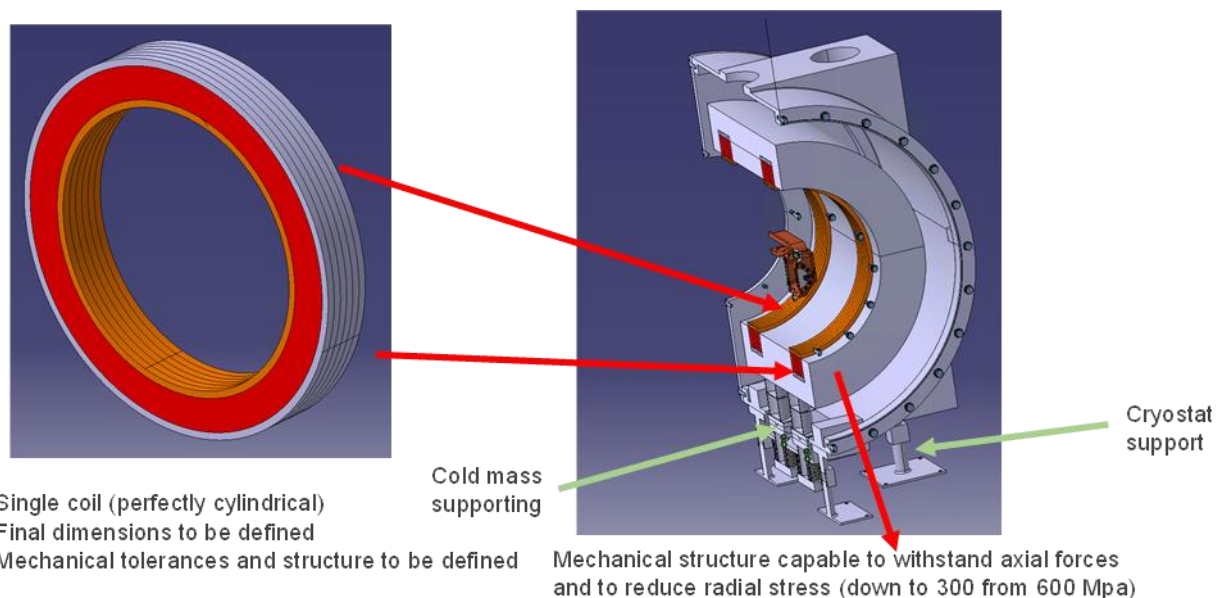

Fig. 11: RFMFTF structural design with single cold mechanical structure for force support

The drawback of the system is that it requires a single cryostat embracing both coils and making it difficult to have radial access. This is the only difference between the magnetic system of the RFMFTF and the one of the cooling cell that will have a room temperature vertical passage to allow

the installation of the RF power coupler and other possible RF auxiliary equipment. It is worth emphasizing that the most important parameter inferred from the RFMFTF design is that the distance that one must take from the inner edge of the coil and the outside of the vacuum vessel at room temperature is **40 mm** (strictly speaking 38 mm). This is the space required for vacuum insulation (the 300 K of the vacuum vessel, to the 60 K thermal shield and from this one to the 20 K coil) and for the thickness of the vacuum vessel wall and thermal shield. This dictates the minimum coil diameter, which is 80 mm larger than the minimal radius that must be kept for the RF system, as it is reported in 3.2.1 section, if the RF system goes inside the coil cryostat. In addition, since the actual cooling cell must have vertical room temperature bore between the two coils, as above mentioned, this 40 mm clearance between coil and room temperature equipment must apply to any warm-cold interface.

In Fig. 12 a view of the test facility with inside (in scale) a 3 GHz RF cell with the waveguide (without its support system) is shown.

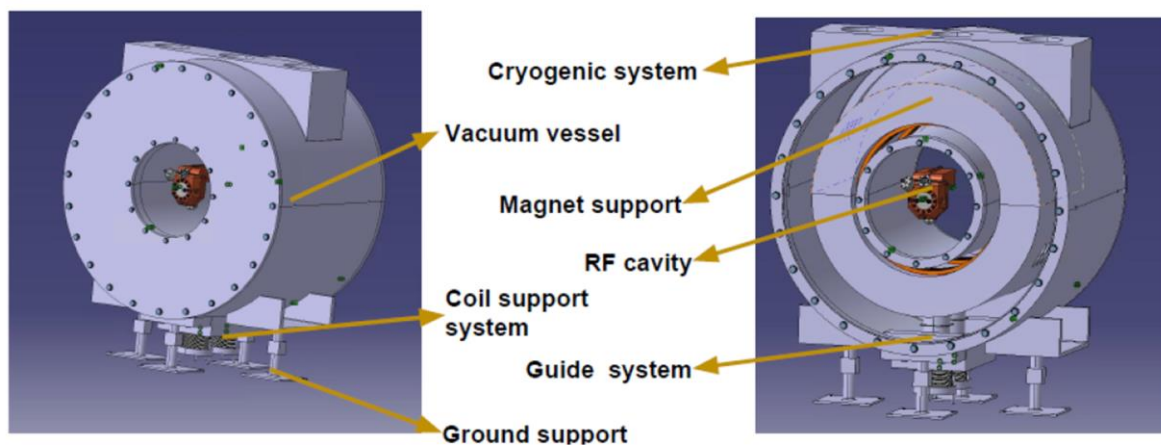

Fig. 12. Global view of the RFMFTF magnetic system with a 3 GHz Cavity inside (w/o support)

5. CONCLUSION

This report describes the technical choices towards a conceptual design of the cooling cell that has been selected to carry out the first integration exercise by WP8. This work will require constant iterations between engineering (WP8) and beam dynamics (WP4) and among the main actors (Magnet, RF and Absorber: WP7, WP6 and WP4). Once a baseline for the conceptual design is approved by every WP, the engineering design will be performed according to the timeline proposed by MuCol.

6. REFERENCES

- [1] Stratakis, D, Palmer, R. B., (2015) Rectilinear six-dimensional ionization cooling channel for a muon collider: A theoretical and numerical study, *Phys. Rev. ST Accel. Beams*, 18, 031003.
- [2] MuCol WP8 Cooling Cell Workshop (2024) CERN, January 18-19, 2024. Available at: <https://indico.cern.ch/event/1335151/>
- [3] 3rd I.FAST Workshop on AI/ML in Accelerators (2024) CERN, February 21-23, 2024. Available at: <https://indico.cern.ch/event/1325963/>
- [4] Roberts, T. G4beamline User's Guide, Muons Inc. Available at: <https://www.muonsinc.com/Website1/G4beamline>