

Optimization of Passive Vibration Damping of Space Structures

Emad Askar, Eldesoky Elsoaly, Mohamed Kamel, Hisham Kamel

Abstract—The objective of this article is to improve the passive vibration damping of solar array (SA) used in space structures, by the effective application of numerical optimization. A case study of a SA is used for demonstration. A finite element (FE) model was created and verified by experimental testing. Optimization was then conducted by implementing the FE model with the genetic algorithm, to find the optimal placement of aluminum circular patches, to suppress the first two bending mode shapes. The results were verified using experimental testing. Finally, a parametric study was conducted using the FE model where patch locations, material type, and shape were varied one at a time, and the results were compared with the optimal ones. The results clearly show that through the proper application of FE modeling and numerical optimization, passive vibration damping of space structures has been successfully achieved.

Keywords—Damping optimization, genetic algorithm optimization, passive vibration damping, solar array vibration damping.

I. INTRODUCTION

VIBRATION control of flexible structures is an important issue in many engineering applications, especially for the precise operation of aerospace systems such as satellite structures.

A. Effect of Vibration on Satellite Structures

Flexible structures have low stiffness and damping ratio. Therefore, any excitation can lead to increase of vibration amplitude and settling time. These can cause fatigue, disturbance and poor operation of the structures [1]. Vibration of mechanical structure at low frequencies is a challenging problem in light weight and flexible structure such as satellites SA structure [2]. SA structure is susceptible to several sources of vibrations during deployment and in orbit operations such as: Satellite maneuver, solar snap effect, and moving parts, as well as propulsion system. Such sources of vibrations cause instability of SA structure, due to the condition of resonance. Therefore, many types of vibration damping techniques were used in space structure applications.

B. Vibration Damping Techniques

Vibration characteristics of many structures are influenced by the mass, stiffness, and damping of the structure [3]. Both mass and stiffness influence the fundamental frequencies of the structure, while damping reduces the peak amplitude of the structure.

There are many methods that are used in vibration control

such as passive, active, and semi-active or hybrid vibration control. In a passive control system, the energy of vibration is dissipated by a damping element without any feedback capability, while in an active system; a force is applied by using actuating elements as piezoelectric actuator in an equal and opposite direction to the forces imposed by the external excitation. A hybrid method combines both approaches [4].

C. Passive Vibration Damping

Passive damping systems can be used in space structures due to their simplicity, capability of suppressing a wide range of mechanical vibrations, and no power consumption required. The physical effect of passive dampers is based on the dissipation of load induced energy. The reduction of the vibration level at a sensitive location of structure can be achieved by three approaches: at source, receiver, and along the vibration path [5].

Passive constrained layer damping (PCLD), using viscoelastic material (VEM) as the core layer, can be used as a reliable and robust means of damping method compared to more recent active constrained layer damping (ACL D) [6]. A large section of papers have been published in the past decades on the vibration damping analysis of PCLD treated beam and plate structures. The performance of PCLD treatments can be maximized by proper choice of materials and geometry, but it has disadvantage concerning to the operating temperature [7]-[9]. In this article, an alternative passive vibration damping using stiffened patches was proposed to comply with the satellite SA operating temperature.

D. Passive Vibration Damping Optimization

In vibration damping techniques, both weight and cost of the structure are considered, where the main designer target is to obtain maximum vibration damping and minimum weight and cost. To decrease the weight, the plate should be partially treated by damping patches or constrained layer patches, and the patches should be placed at the optimal locations to decrease the plate vibrations. Hence patch locations are a paramount influence. It has direct effect on both vibration control efficiency and cost [10].

Genetic algorithm was used to optimize patch locations for flexible structure. Many experimental results denoted that the best vibration damping is obtained when patches are bonded near the fixed end than placing it at near free end of a plate. The position of patches depends on the mode shapes; therefore we have to determine the most effective modes in the structure [11]-[13].

In order to optimizing the configuration of the added patch,

E.A. Askar is with the Egyptian Armed Forces, Egypt (phone: 002-01125633680, e-mail: emadaskar2@gmail.com).

we have to prepare pre-shaped patch and then try to optimally locate them on the proposed structure. However the shape of patch plays an important role in the vibration damping performance. Masoud Ansari concluded that the circular shape is considered the optimal shape of patch, it gives 10% more damping ratio compared with a square shape [10]. Hence circular patch will be used in our study.

E. Optimal Location of Damping Patches

Recently, there are many optimization techniques used with ANSYS Workbench, such as Multi-objective genetic algorithm (MOGA), screening, and adaptive multi-objective optimization methods were used to optimize the location, shape, and size of the patches.

In this article, MOGA optimization method is used to optimize the size, and the patch locations to minimize the amplitude of the plate vibration at the first two bending modes.

Since the energy dissipation is related to the strain rate, it is very important to perform a modal analysis on the structure before starting direct optimization, to determine the locations that have highest modal strain energy. The patch then located at those locations in order to increase the chance of finding the global minimum. This will also help in reduction of optimization time. For FE model, finer meshes will lead to accurate results however having more elements will increase the computational cost, hence we have to optimize between them. In our case the higher modal curvature for the first bending mode is close to the fixation end, therefore the optimization process started from the initial estimation of patch locations at the plate fixation end.

The optimization requires much iteration to converge, the convergence achieved at a condition of; 40 initial samples, 15 samples per iteration, and 15 iterations. Fig. 1 shows the Aluminum (AL) plate mesh with different patch locations: the plate without patches, root locations, middle locations, and optimal locations.

II. MODAL ANALYSIS AND EXPERIMENTAL VERIFICATION

A. Test Specimen's Properties

An aluminum rectangular plate was used and six damping patches are also assumed to be from different space used materials (aluminum (AL), epoxy graphite, and epoxy glass). The dimensions of the plate were chosen based on the actual dimensions of satellites SA structure.

Table I shows dimensions and properties of the test specimen and patches used in the FE model analysis and experimental set up.

TABLE I
 TEST SPECIMENS' TECHNICAL PROPERTIES

Specimen name	Material type	Dimensions (mm)	Young's modulus E (GPa)	Density ρ (kg/m ³)	Poisson's ratio ν
AL plate	AL 5056	500x200x1.2	70	2660	0.33
Damping patches	Epoxy graphite	ϕ 44x1.2	209	1540	0.27
	Epoxy glass		45	2000	0.3

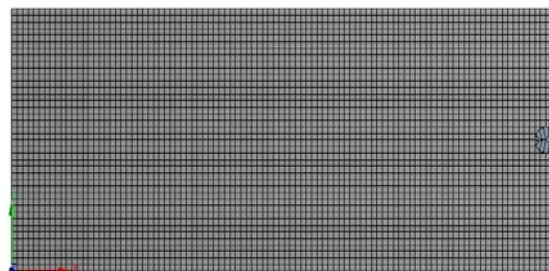

(a)

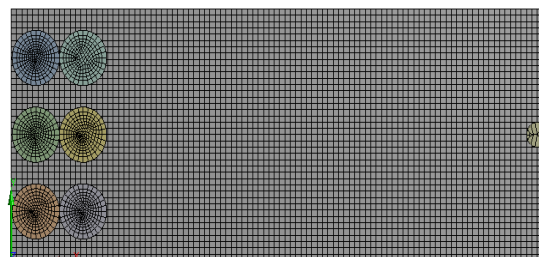

(b)

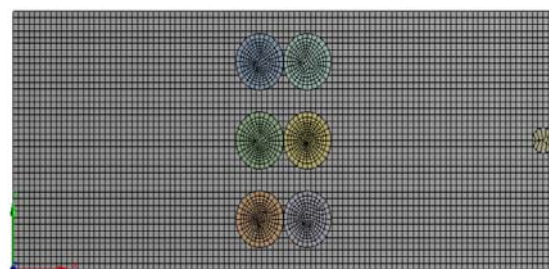

(c)

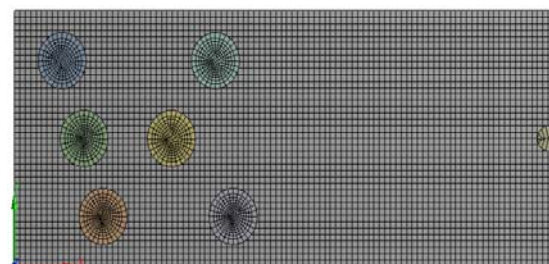

(d)

Fig. 1 AL plate mesh with different patch locations: (a) without patches, (b) root locations, (c) middle locations, (d) optimal locations

B. FE Modeling of the System

FE model of the plate and patch was done using ANSYS Workbench version R15.0. An isotropic AL rectangular plate of homogenous material is considered with dimensions (500 mmx200 mmx1.2 mm). Six isotropic circular patches with 44 mm diameter and 1.2 mm thickness were bonded with the base plate based on MOGA optimization method. Then the structure discretized into smaller elements of identical shapes and sizes.

Cantilever boundary conditions are applied to the FE model which contains 4036 elements and 28962 nodes. The element number is decided after a convergence study made for the

ANSYS model. Mode shapes and natural frequencies (NF) of the plate with/without patches are obtained by modal analysis tool, and a harmonic response tool was applied to study the plate frequency response function (FRF) for the first and second bending modes.

C. Experimental Setup

The direct goal of the experimental work is to check the validity of the numerical model. The experimental set up consists of: Commercially available 99% pure aluminum rectangular plate type (5056), with one end clamped in a fixed support and the other end is free. Fig. 2 shows a schematic view of the experimental setup.

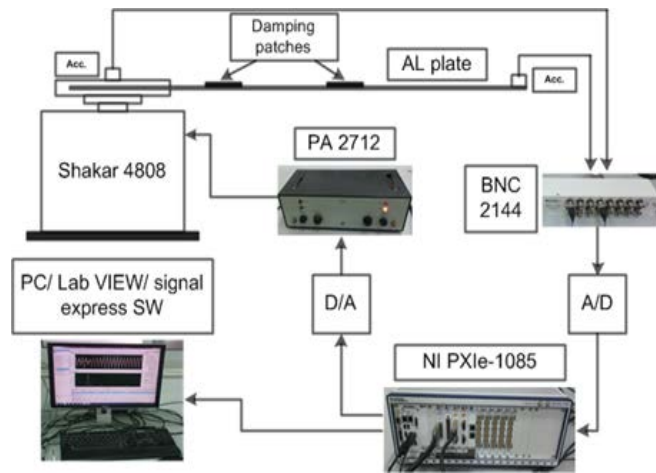

Fig. 2 A schematic view of experimental setup

The tested plate is attached to B&k (Bruel& Kjaer) shaker type 4808 which excites the tested plate by sine sweep signal 0-200 Hz. The shaker is driven by B&k PA (Power amplifier)

type 2712 which amplifies the sine sweep function coming from NI PXIe-6368& NI SCB-68A system through Lab VIEW program. The vibration amplitude depends mainly on the voltage applied to the shaker. Chasses of NI (National Instrument) type PXIe-1085 are used for data acquisition system. Two accelerometers type PCB PIEZOTRONICS are bonded on the host structure by a suitable adhesive, one in the proximity of the fixed end, and the other at the tip of the plate. The output signals are sent to NI adapter type BNC-2144 which is connected to analogue input NI PXIe-4499. Six patches are bonded on the base structure in optimal locations by high strength epoxy glue. A PC with Lab VIEW signal express 2015 SW is used to acquire and analysis the data. The most suitable technique used for characterizing the patch material properties in the frequency range from 1 Hz up to 1 KHz is the frequency response technique [4].

III. RESULTS AND DISCUSSION

A. FE Modeling Verification

To verify the FE model, the FE model results compared with the experimental ones.

Figs. 3 and 4 show the numerical and experimental FRF of the plate with/without patches at first and second bending modes respectively.

The comparison between the resonant frequencies of the numerical simulation and the experimental results are shown in Table II.

The results, given in Table II, show that the experimental and FE model results are in a good agreement, where maximum error within 12%.

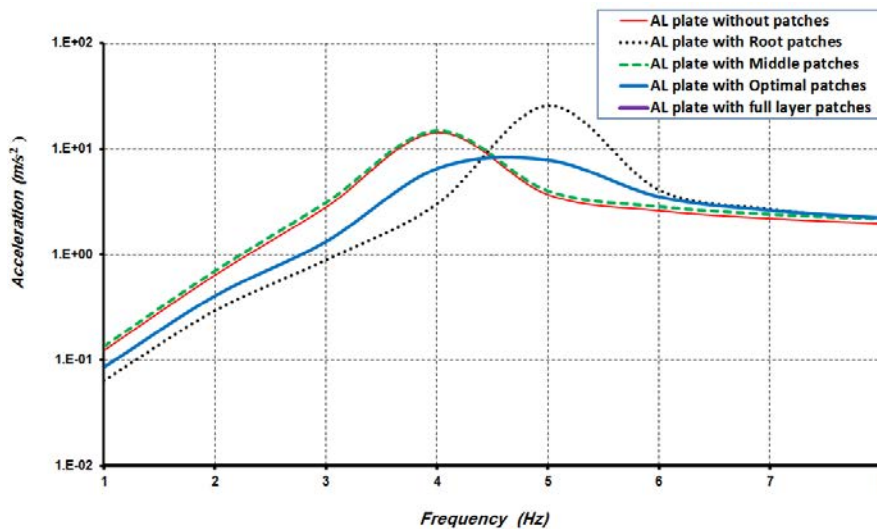

(a)

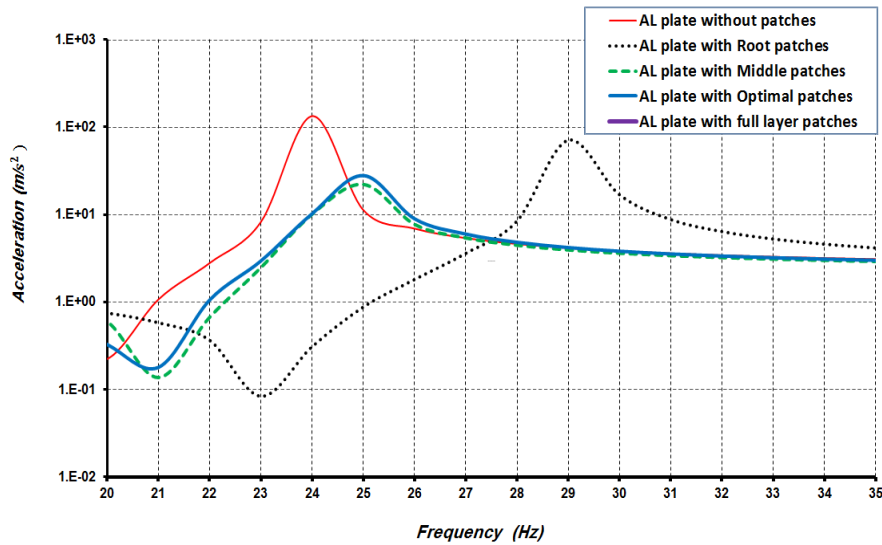

(b)

Fig. 3 Numerical FRF of the plate at different patch locations: (a) First bending mode, (b) Second bending mode

B. Parametric Study

A parametric study was conducted after optimization to compare between optimal patch locations and non-optimal ones (at root and at middle locations). The study was applied for first and second bending modes.

The results of a parametric study are described as:

- 1) The effect of patch locations at different maximum strain energy areas as shown in Fig. 1.

The plate amplitude FRF at different patch locations for first and second bending modes was shown in Fig. 5.

The results show that the optimum patch locations using MOGA optimization method satisfy higher damping ratio for first and second bending modes, compared with the root and middle locations.

- 2) The effect of patch materials was investigated using three types; AL, epoxy graphite, and epoxy glass as shown in Table I.

The plate amplitude FRF with different patch materials was shown in Fig. 6.

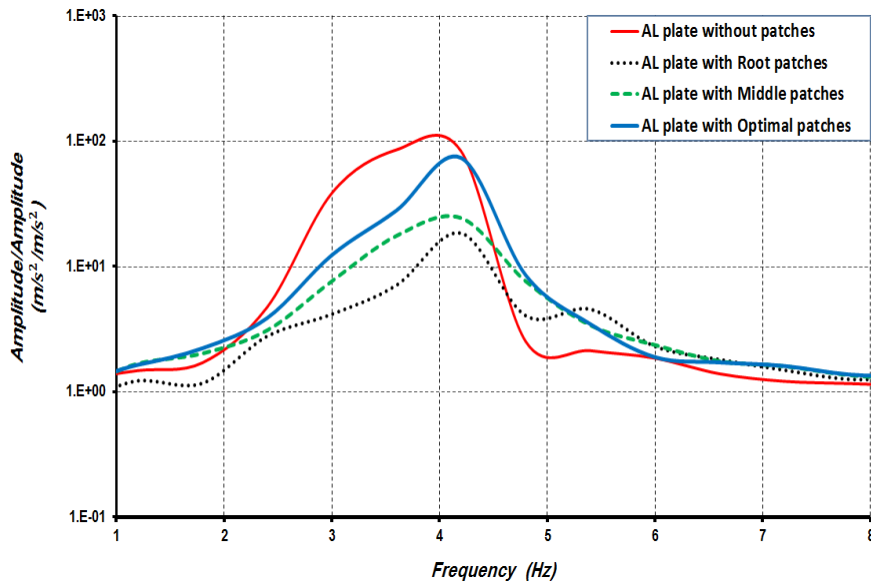

(a)

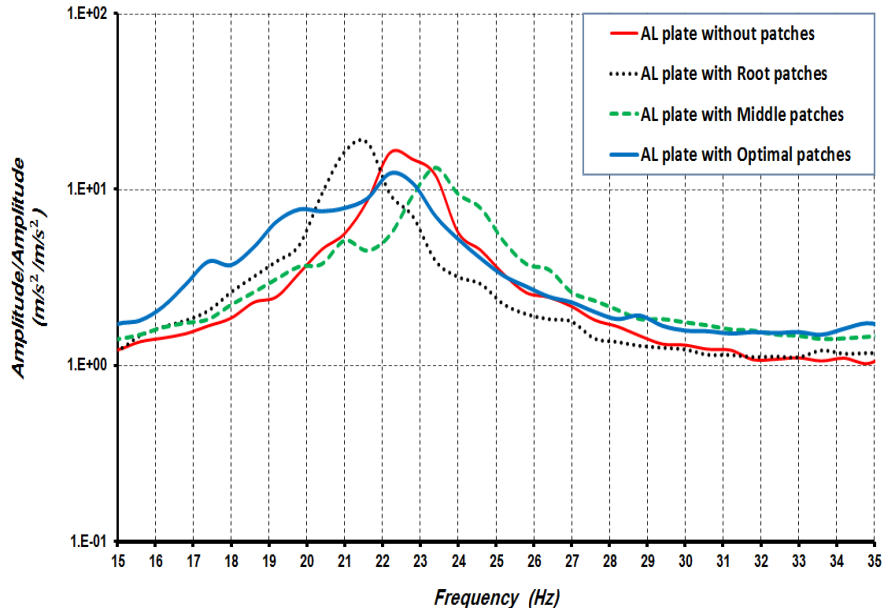

(b)

Fig. 4 Experimental FRF of the plate at different patch locations: (a) First bending mode, (b) Second bending mode

TABLE II
 RESONANT FREQUENCIES OF THE PLATE WITH/WITHOUT PATCHES AT DIFFERENT LOCATIONS (NUMERICALLY/EXPERIMENTALLY)

Mode	Resonant frequency of the plate (HZ)							
	Without patches		Root locations		Middle locations		Optimal locations	
	Num.	Exp.	Num.	Exp.	Num.	Exp.	Num.	Exp.
1	3.77	3.6	4.81	4.2	3.83	4.2	4.47	4.2
2	23.9	22.2	28.84	21.6	25.85	23.4	24.7	22.2

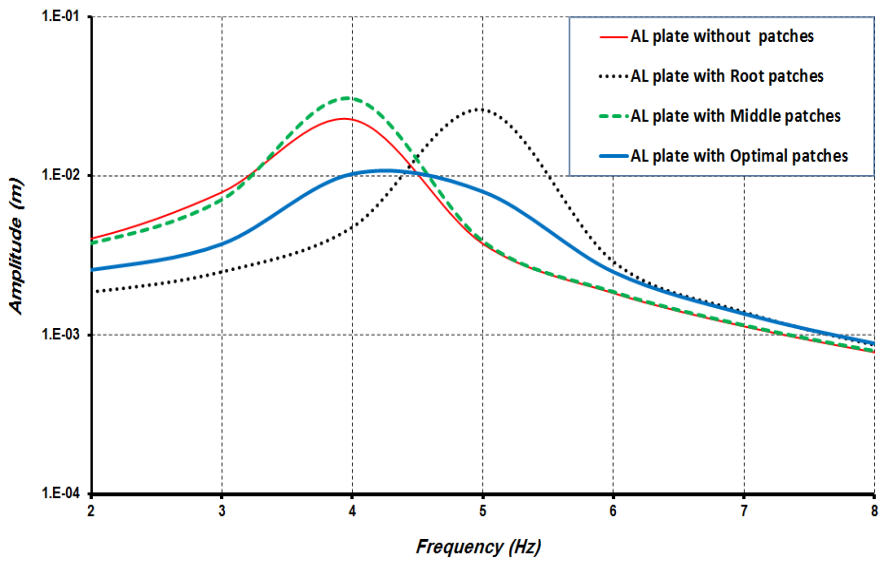

(a)

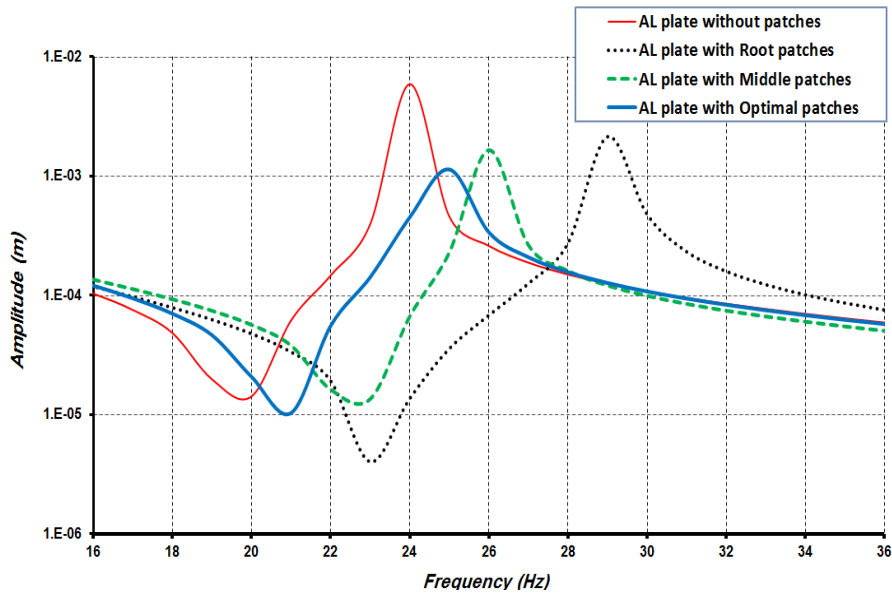

(b)

Fig. 5 The plate amplitude FRF at different patch locations: (a) First bending mode, (b) Second bending mode

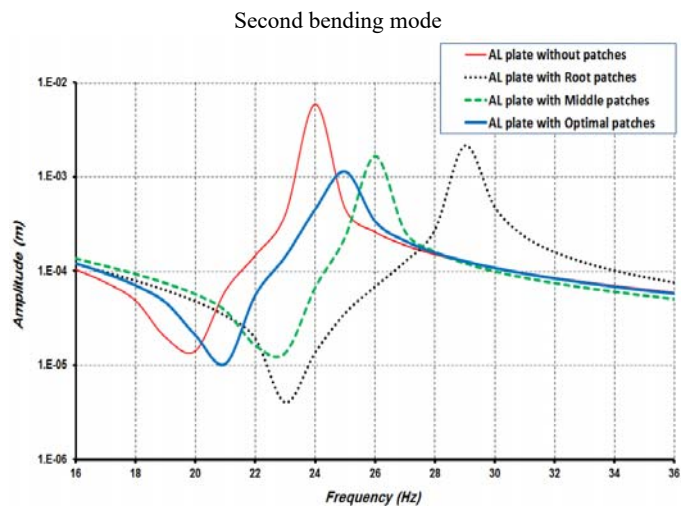
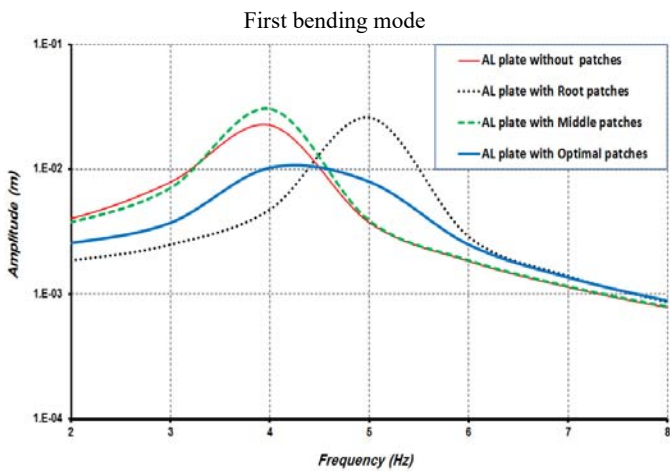

(a)

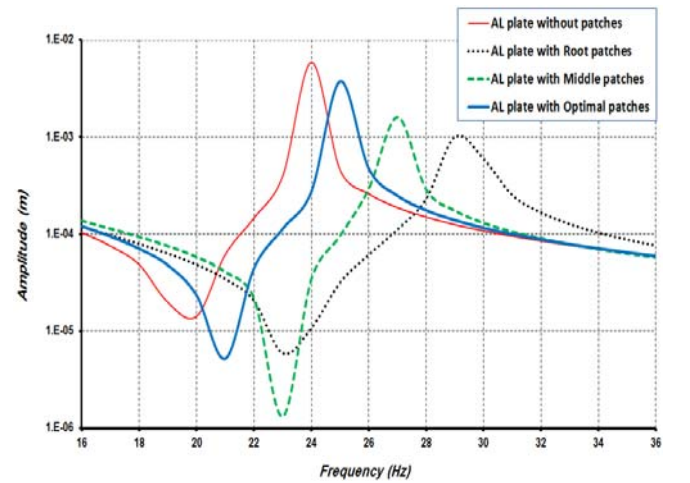
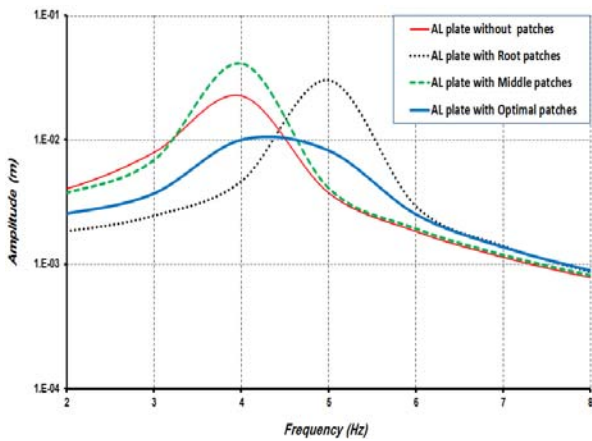

First bending mode

Second bending mode

(b)

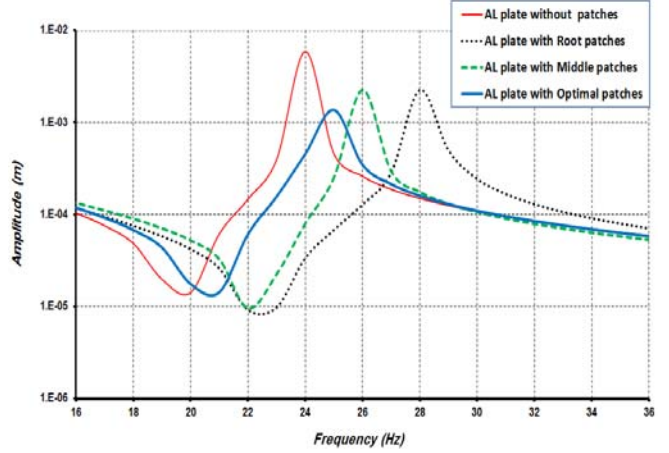
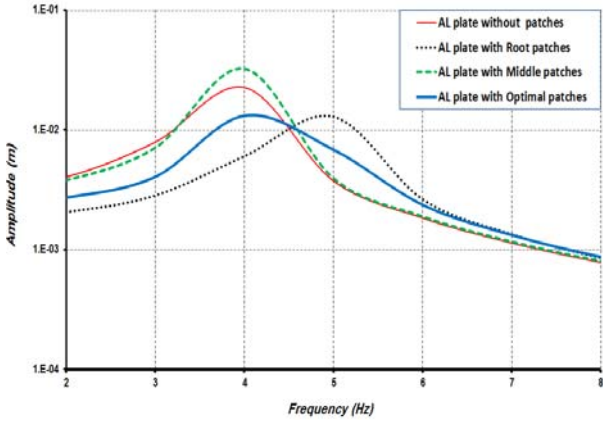

(c)

Fig. 6 The plate amplitude FRF at different patch materials: (a) AL patches, (b) Epoxy graphite patches, (c) Epoxy glass patches

First bending mode

Second bending mode

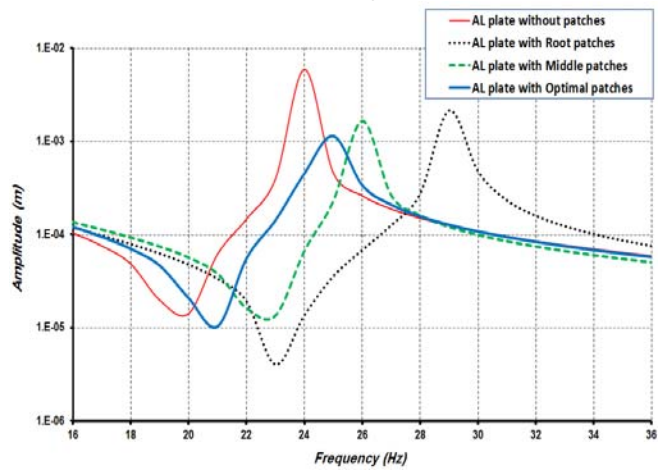
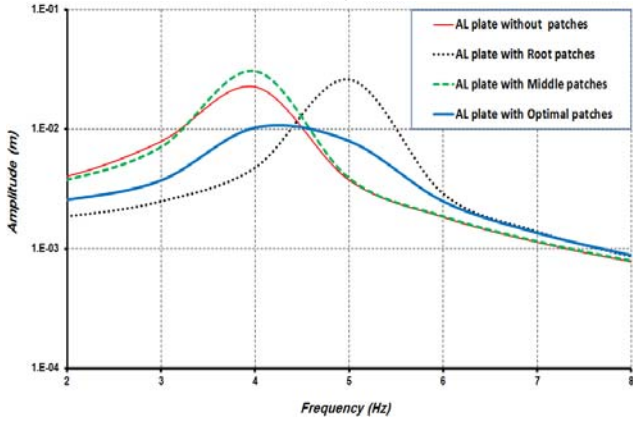

(a)

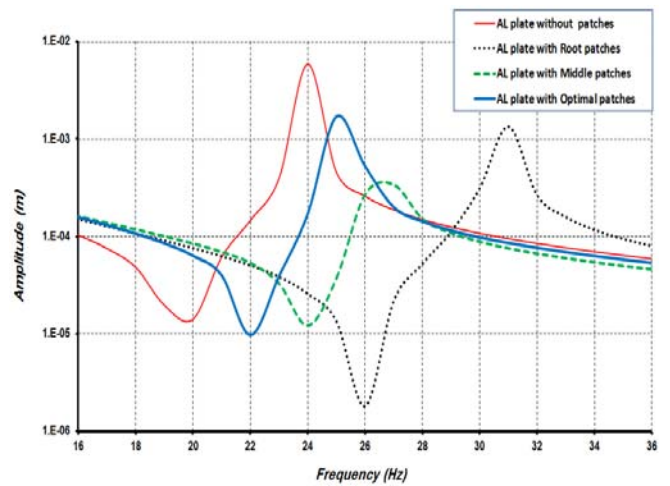
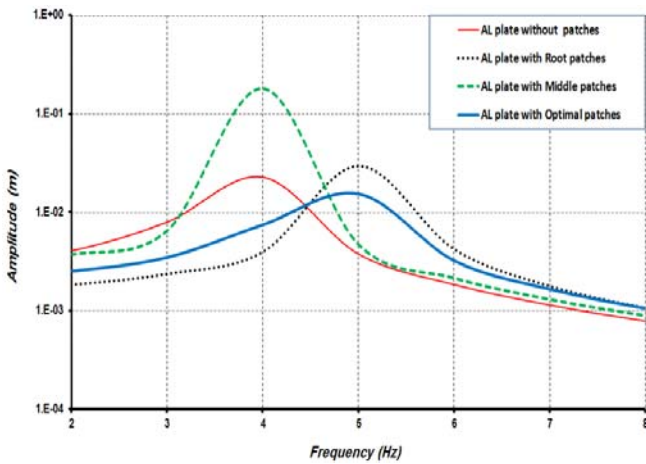

(b)

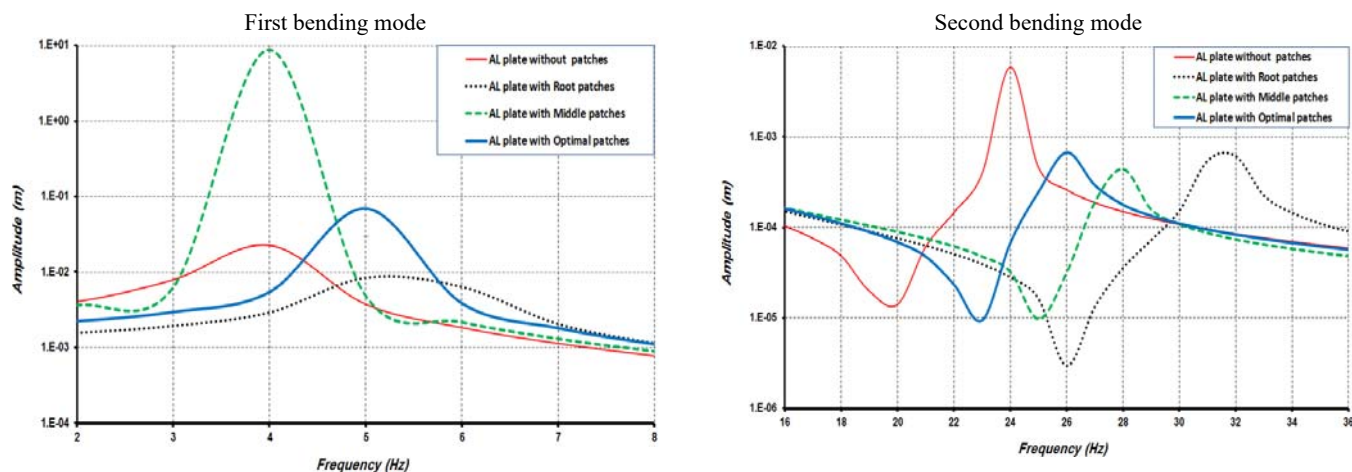

(c)

Fig. 7 The plate amplitude FRF at different patch shapes: (a) Circular patches, (b) square patches, (c) rectangular patches

The results show that there is significant plate damping when using different stiffened patch materials, and AL patches satisfy higher damping ratio for first and second bending modes, compared with epoxy graphite, and epoxy glass materials.

3) The effect of patch shapes was investigated using three types; circular, square, and rectangular shapes.

The plate amplitude FRF at different patch shapes was shown in Fig. 7. The results show that when using circular patches, there is a significant increase in damping ratio, and resonant frequency especially for optimal patch locations.

IV. CONCLUSIONS

It can be concluded from simulation and experimental results that aluminum circular patches properly located on a space structure are remarkably effective in attenuating vibration within a broad frequency range, especially for the first and second bending modes.

REFERENCES

- [1] S. Havaldar, R. Sharma¹, V. Raghupathy and M. Adiga "Evaluation of dynamic parameters of adhesively bonded steel and aluminum plates", ARPN Journal of Engineering and Applied Sciences, 2012.
- [2] V. Tatavolu and S. Panchumarthy, "Embedded computer based active vibration control system for vibration reduction of flexible structures" Journal of Computer Science, ISSN: 1549-3636, 2013.
- [3] K. Sasikumar "Experimental investigations of the effect of constraining layer parameters in vibration control of structures" International Journal of Advanced Research in Engineering and Applied Sciences, ISSN: 2278-6252, 2015.
- [4] H. Ji, J. Qiu and P. Xia "Semi-active Vibration Control Based on Switched Piezoelectric Transducers" Nanjing University of Aeronautics and Astronautics, China, 2010.
- [5] G. Aglietti¹, R. Langley, E. Rogers and S. Gabrie "Model Building and Verification for Active Control of Microvibrations with Probabilistic Assessment of the Effects of Uncertainties" J. Mechanical Engineering Science, 2004.
- [6] P. Hujare, A. Sahasrabudhe "Experimental investigations of damping performance of viscoelastic material using constraining layer damping treatment" Elsevier, International Conference on Advances in Manufacturing and Engineering AMME 2014.

- [7] K.S.K Sasikumar "Vibration control of Beam with Composite Constrained Layer Treatment" International Journal of Latest Trends in Engineering and Technology (IJLTET) 2015.
- [8] A. Zurich "Composite laminates with integrated vibration damping treatments", France, A thesis of Doctor of Philosophy, 2012.
- [9] P. Marcotte "A study of distributed active vibration absorbers (DAVA)", Blacksburg, Virginia, A thesis of Doctor of Philosophy, 2004.
- [10] M. Ansari "Optimal Vibration Control in Structures using Level set Technique", Waterloo, Ontario, Canada, A thesis of Doctor of Philosophy, 2013.
- [11] A.H. Daraji, J. M. Hale and R. Bicker "Active vibration control of a smart structure", School of Mechanical and Systems Engineering, Newcastle University, 2008.
- [12] S. Kumar, R. Srivastava, R. Srivastava "Active vibration control of smart piezo cantilever beam using PID controller" International Journal of Research in Engineering and Technology IJRET, 2014.
- [13] N. Shoushtari "Optimal Active Control of Flexible Structures Applying Piezoelectric Actuators" Waterloo, Ontario, Canada, A thesis of Doctor of Philosophy 2013.