

# Application of Voltage Stability Indices for Proper Placement of STATCOM under Load Increase Scenario

A. S. Telang, P. P. Bedekar

**Abstract**—In today's world, electrical energy has become an indispensable component of all aspects of modern human life. Reliability, security and stability are the key aspects of any power system. Failure to meet any of these three aspects results into a great impediment to modern life. Modern power systems are being subjected to heavily stressed conditions leading to voltage stability problems. If the voltage stability problems are not mitigated properly through proper voltage stability assessment methods, cascading events may occur which may lead to voltage collapse or blackout events. Modern FACTS devices like STATCOM are one of the measures to overcome the blackout problems. As these devices are very costly, they must be installed properly at suitable locations, mostly at weak bus. Line voltage stability indices such as FVSI, Lmn and LQP play important role for identification of a weak bus. This paper presents evaluation of these line stability indices for the assessment of reliable information about the closeness of the power system to voltage collapse. PSAT is a user-friendly MATLAB toolbox, of which CPF is an important feature which has been extensively used for the placement of STATCOM to assess the stability. Novelty of the present research work lies in that the active and reactive load has been changed simultaneously at all the load buses under consideration. MATLAB code has been developed for the same and tested successfully on various standard IEEE test systems. The results for standard IEEE14 bus test system, specifically, are presented in this paper.

**Keywords**—Voltage stability analysis, voltage collapse, PSAT, CPF, VSI, FVSI, Lmn, LQP.

## I. INTRODUCTION

**D**UE to ever increasing demand of power and inability to establish new transmission lines owing to their complexity, modern power systems have been recently operating close to their network stability limits. Operating power systems under such stressed conditions initiates the problem of voltage instability. This may result into complete blackout or voltage collapse. Such kinds of abnormal voltages and voltage collapse pose primary threat to power system stability, security and reliability. Thus, voltage stability has been identified as one of the major concerns in power system planning and operations.

According to Cutsem [1], voltage stability refers to the ability of a power system to maintain steady voltages at all buses in the system after being subjected to a disturbance from a given initial operating condition. It depends on the ability to

maintain/restore equilibrium between load demand and load supply from the power system. Also, voltage collapse is the process by which voltage instability leads to loss of voltage in a significant part of a power system [2], [3]. Hence, forecasting the voltage collapse is an essential part of power system planning and secure operation. Several voltage stability indices can be easily used for voltage collapse prediction. These indices give important information about the proximity of voltage instability in a power system and identification of the weakest bus, line and area in the power network. Usually their values change between 0 (no load) and 1 (voltage collapse). Voltage stability index based on minimum singular values for the power flow Jacobian matrix has been used as a static voltage stability index [4], [5]. Line voltage stability indices based on the concept of power flow through a single line have been proposed in [6]-[11]. Thus, these voltage stability indices identify the weakest possible areas in the power system networks. Furthermore, the enhancement of voltage stability of the power system can be obtained by adding shunt capacitors and/or FACTS controllers at the bus where voltage magnitude is low (weak bus). STATCOM is an important member of FACTS family. Owing to the high costs, its proper location is of great importance. The systematic approach for this has been presented in [12]-[14] respectively, where MATLAB user friendly power system analysis toolbox (PSAT) [15], [16] is extensively used for the purpose of analysis.

This paper presents a comparison of various line voltage stability indices. These indices provide reliable information on the proximity of a power system to voltage instability. The results are obtained from simulation on various standard test systems. However, the results for standard IEEE14 bus test system are presented in this paper. Usually the values of voltage stability indices change between 0 (no load) and 1 (voltage collapse). Once the weak bus is identified by these voltage stability indices, CPF feature of PSAT is used for determining the proper location of STATCOM in the system for enhancement of voltage stability. The special feature of this paper is that, simultaneous change in the active and reactive load at all the buses has been taken into consideration.

## II. VOLTAGE STABILITY AND VOLTAGE COLLAPSE

The voltage stability analysis is carried out by classifying it into dynamic and static approaches. The static voltage stability analysis methods depend mainly on the steady state model, specifically power flow model whereas, the dynamic analysis

A. S. Telang, research scholar, and P. P. Bedekar, Associate Professor, are with the Government college of Engineering, Amravati, India (e-mail: apama\_telang2002@yahoo.com, bedekar\_pp@rediffmail.com).

depends on nonlinear differential equation based model, e.g. tap changing transformers, generator dynamics etc. Static voltage stability can be best studied using V-Q and P-V curve analysis tools. V-Q analysis is very important for reactive reserve margin enhancement and P-V analysis is an efficient tool to determine real power transfer capability of transmission line.

For a very small duration of disturbance occurring in power system say for a few seconds or a minute, the voltages may experience large, progressive and pronounced falls leading to voltage instability. This instability is due to the behavior of load dynamics to restore power consumption beyond its capacity and thus results into voltage collapse/blackout. Several factors contributing to voltage collapse are-

- Increase in loading
- Reactive power limits of generators, synchronous condensers
- Action of tap changing transformers
- Dynamics of load recovery system
- Generator outages or line tripping

A number of countermeasures have been adopted to control emergency or blackout situations, a few of which are

1. Use of series compensation, fast acting automatic regulators, automatic controls for switching of capacitor banks, use of properly set and coordinated excitation control systems etc. to ensure full reactive power support during voltage instability.
2. Use of tap changing transformers.
3. Load shedding is one of the measures to mitigate voltage collapse.
4. Use of appropriate system protection schemes.

An accurate knowledge of how close an actual system's operating point is from the voltage stability limit is very important from the point of view of the power system operators. Hence, finding a voltage stability index has become an important tool for many a voltage stability studies.

### III. VOLTAGE STABILITY INDEX

The basic tools which calculate a power system's proximity to voltage collapse are known as Voltage Stability Indices (VSI). These indices are much useful for identification of a weak bus and critical lines in the system. VSI calculation has become an important task for many voltage stability studies. These indices are broadly classified into three groups viz., i) Index based on Jacobian matrix, ii) Line VSI and iii) Bus or nodal VSI. Out of these, line stability indices are easier to calculate and also effective in identifying the weak bus as well as the critical line in the power system.

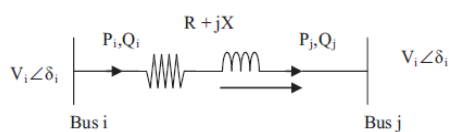

Fig. 1 Power line model

### IV. LINE VSI

VSI provide reliable information on the proximity of voltage instability in a power system. The basic mathematical formulae for various VSI using the power line model, given in Fig. 1, are presented in this section.

The line VSI can be expressed as-

#### A. Fast Voltage Stability Index (FVSI)

The FVSI is based on the concept of power flow through a single line [8], [9]. It has been formulated as:

$$FVSI_{ij} = \frac{4 * Z^2 * Q_j}{V_i^2 * X} \quad (1)$$

where Z - the line impedance; X - the line reactance;  $Q_j$  - the reactive power at the receiving end; and  $V_i$  - the sending end voltage.

The most critical line of the bus will have index value closest to 1 and the bus with the smallest maximum permissible load corresponds to the weakest bus.

#### B. Line Stability Index (Lmn)

In [8]-[10], the line stability index Lmn is given as:

$$L_{mn} = \frac{4 * X * Q_j}{[V_i * \sin(\theta - \delta)]^2} \quad (2)$$

where X - is the line reactance;  $Q_j$  .the reactive power at the receiving end;  $V_i$  .the sending end voltage;  $\theta$  - the line impedance angle, and  $\delta$  - the angle difference between the supply voltage and the receiving end voltage.

To maintain stable system, the value of Lmn must be less than 1.00.

#### C. Line Stability Factor (LQP)

The LQP is obtained using the same concept as in obtaining in line stability index [8]-[10]. It is expressed as:

$$LQP = 4 * \left[ \frac{X}{V_i^2} \right] * \left[ \frac{X}{V_i^2} * P_i^2 + Q_j \right] \quad (3)$$

where X - the line reactance;  $P_i$  -the real power at the sending end;  $V_i$  -the sending end voltage, and  $Q_j$  - the reactive power at the receiving end.

For system to be stable, LQP must be lower than 1.00.

### V. STATIC SYNCHRONOUS COMPENSATOR

The most comprehensive and versatile FACTS device is a static synchronous compensator (STATCOM) [12]. It is connected in shunt with the power system and is designed to control the voltage level in the bus where it is connected through the generation or consumption of reactive power. Fig. 2 shows a simple diagram of the STATCOM based on a voltage source converter. It consists of a shunt transformer, a VSC, a dc capacitor, a magnetic circuit and a controller. Here

the inherent STATCOM model in MATLAB PSAT toolbox is used.

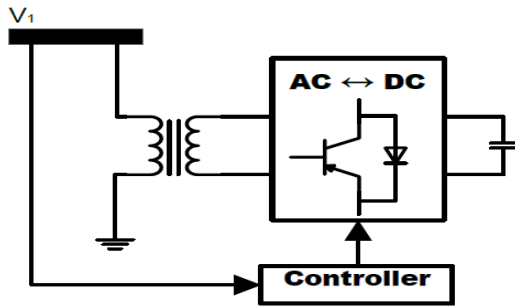

Fig. 2 Detailed Scheme of the STATCOM

## VI. RESULTS AND DISCUSSIONS

The three line stability indices have been computed for various standard IEEE test systems and the results of IEEE 14 bus test system consisting of 5 generators, 9 load buses and 20 interconnected branches, shown in Fig. 3, have been presented here.

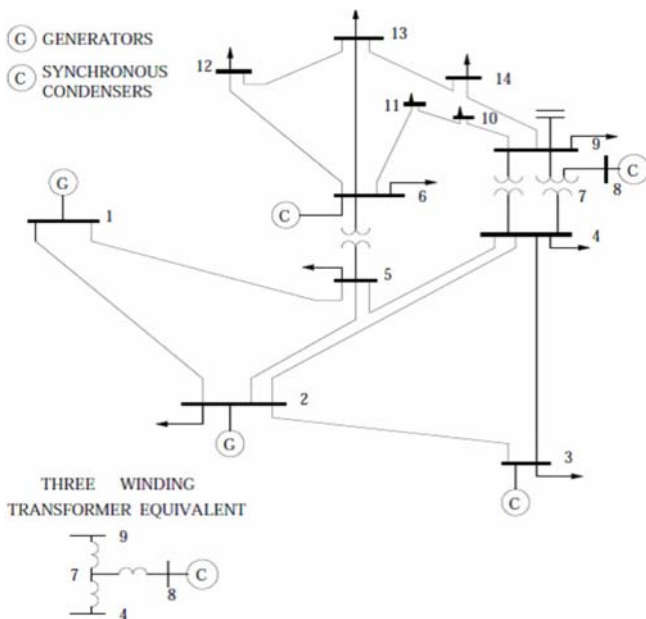

Fig. 3 Standard IEEE14 bus test system

The computation of these line indices has been done based on load flow analysis carried out using N-R load flow under MATLAB environment. MATLAB programme has been developed for various loading patterns, such as:

- Case 1: Active load change at individual load bus.
- Case 2: Reactive load change at individual load bus.
- Case 3: Active and Reactive load change at individual load bus.
- Case 4: All above three cases, for the load change simultaneously on all load buses.

To analyze line VSI for weak bus identification, firstly active load at individual load bus is changed. It is observed that line stability index LQP gives better results compared to

remaining indices FVSI and Lmn, whereas for the case 2 and 3, FVSI and Lmn are significant. Case 4, for which, all the three cases are tested for simultaneous load change, adds important observation in determination of weak bus. For this novel case, almost all line indices are near to the proximity of voltage collapse. The results are summarized in Table I for different loading pattern. To maintain the conciseness of the ongoing discussion, results of bus no.14 with the loading just prior to the loading level for which load flow program fails to converge, are shown. Also the lines which violate the indices values are considered critical lines in spite of not being connected to the bus under investigation. To understand the response of critical lines on concerned load bus, variation of Line indices such as FVSI, Lmn and LQP with reactive power load only for critical lines of bus 14 (line 16, connected between bus 9 and 14, and line 25, connected between bus 13 and 14) have been shown in Figs. 4, 5 and 6 respectively. It is obvious from those results that comparative study of line indices estimates the relative proximity to the point of voltage collapse. Also, it can be interpreted that the Line stability indices specially FVSI and Lmn are based on reactive power and hence not giving satisfactory results for real power loading case whereas line stability index, LQP is related to the real power flow and hence give better results for real power loading.

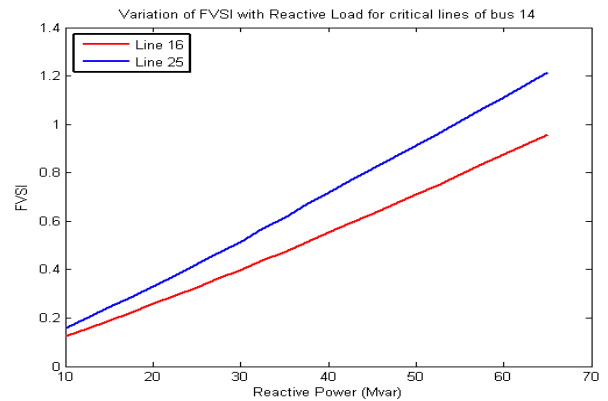

Fig. 4 Variation of FVSI with Reactive Load

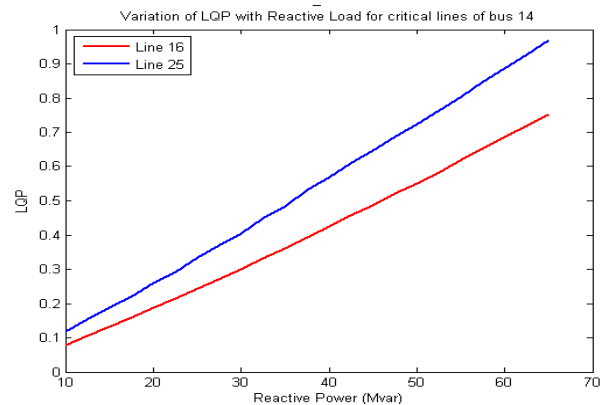

Fig. 5 Variation of LQP with Reactive Load

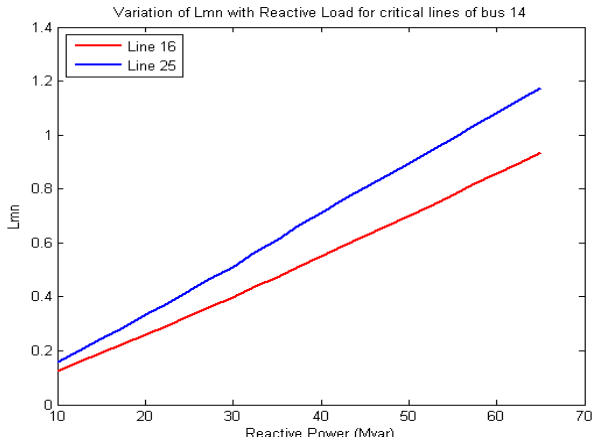

Fig. 6 Variation of Lmn with Reactive Load

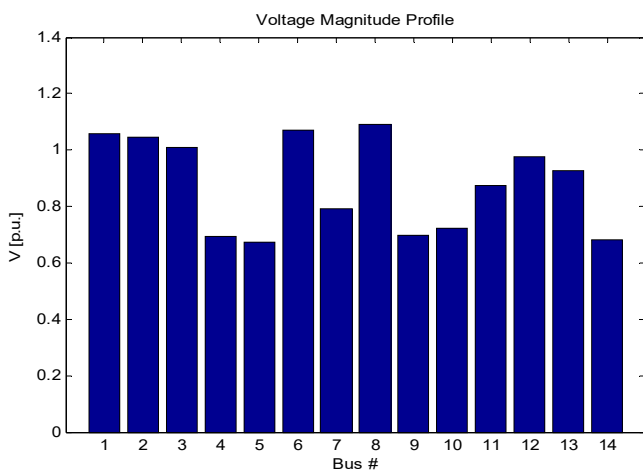

Fig. 7 Voltage magnitude profile

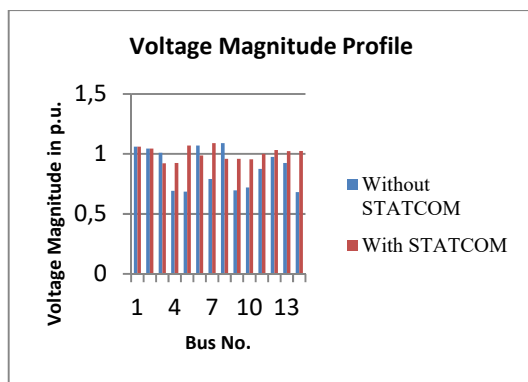

Fig. 8 Voltage magnitude profile with and without STATCOM

From Table I, it is found that bus 14 is the weakest bus where almost all line stability indices have threshold value close to/or greater than 1. Continuation power flow (CPF) feature of PSAT is used for verification of results obtained by line stability indices. It is also useful for the determination of proper placement of STATCOM in the power system. CPF is one of the static methods of voltage stability which consists of predictor and corrector steps and is accurate to carry out the simulations on standard IEEE test systems. Results have been

demonstrated in Fig. 7, which shows that bus no.14 is the weakest bus (minimum voltage level at bus 14, 0.68148 p.u.), which is the same as found by line stability indices.

Using inherent STATCOM model of PSAT, simulations were carried out on IEEE14 bus test system. It was observed that voltage stability has been improved (i.e. loadability margin is increased) with properly placed STATCOM i.e. STATCOM placed at bus no.14. This is shown in Figs. 8-10.

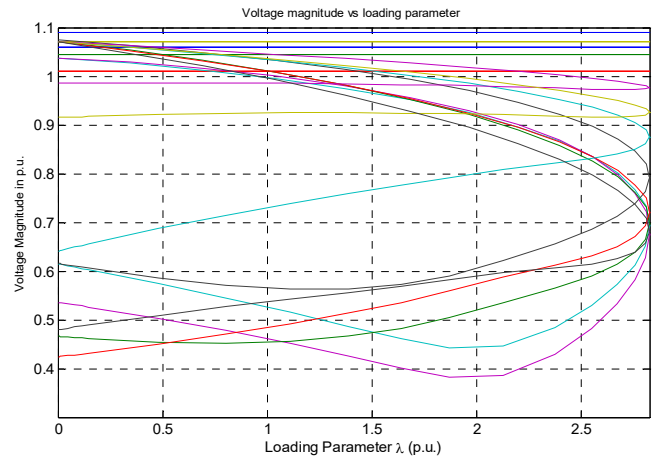

Fig. 9 Loadability margin without STATCOM

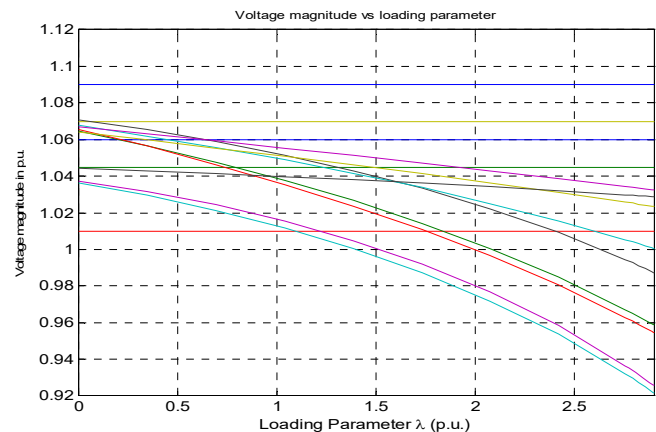

Fig. 10 Loadability margin with STATCOM

The encouraging results obtained from CPF feature of PSAT with STATCOM placed at bus 14, are presented in Table II.

## VII. CONCLUSIONS

Voltage stability assessment based on line VSI is very useful for the power system operators in order to maintain power system voltage stability. The line indices viz., FVSI, Lmn and LQP have been calculated for various standard IEEE test systems and results of IEEE 14 test system have been specifically presented in this paper. These line indices are used for determining the weak bus of power systems and also the critical line referred to a bus. Identification of critical lines and weak bus is important and plays a key role in the optimal placement of FACTS devices, like STATCOM, to enhance the

voltage stability. It has been demonstrated here that properly placed STATCOM improves the voltage stability of the entire system.

TABLE I  
RESULTS FOR VSI OF 14-BUS TEST SYSTEM  
A. LOAD CHANGE AT INDIVIDUAL LOAD BUS

Loading pattern at Bus14	Lines	FVSI	Lmn	LQP
Active load change (P=0.149 p.u to 1.937 p.u).	5-6	0.9629	1.0504	0.9648
	11-6	0.8881	0.8780	0.7234
	12-6	1.1202	1.0727	0.9112
Reactive load change (Q=0.05 p.u to 8.45 p.u)	9-14	1.0014	0.9737	0.7880
	13-14	1.2667	1.2229	1.0101
Both Active Reactive load change (P=1.788 p.u and Q=0.6 p.u)	5-6	1.0462	1.1232	1.0480
	11-6	0.9893	0.9814	0.8058
	12-6	1.2442	1.2036	1.0160

B. LOAD CHANGE SIMULTANEOUSLY ON ALL LOAD BUSES

Loading pattern	Lines	FVSI	Lmn	LQP
Active load change	4-2	1.4293	1.2893	1.8865
	5-6	1.3189	1.5296	1.3483
	11-6	1.1024	1.0560	0.9006
	12-6	1.3630	1.2826	1.1207
Reactive load change	4-9	1.3153	1.3247	1.0225
	14-9	0.9510	0.9357	0.7689
Both Active Reactive load change	4-9	1.0942	1.1606	1.3878
	5-6	1.0106	1.0859	1.0229
	11-6	0.9413	0.9199	0.7680
	12-6	1.1512	1.1057	0.9421

TABLE II  
VOLTAGE MAGNITUDE IN P.U. AND WEAK BUS

Bus No.	Vm without STATCOM in p.u.	Vm with STATCOM in p.u.	Max. loadability $\lambda(p.u.)$	
			Without STATCOM	With STATCOM
1	1.06	1.06		
2	1.045	1.045		
3	1.01	0.9217		
4	0.6928	0.9256		
5	0.68532	1.07		
6	1.07	0.98722		
7	0.79138	1.09	2.8286	2.9091
8	1.09	0.9587		
9	0.6974	0.9587		
10	0.7206	0.9545		
11	0.8751	1.0005		
12	0.9762	1.0324		
13	0.9259	1.0234		
14	0.6815	1.0285		

REFERENCES

[1] T. Van Cutsem and C. Vournas, "Voltage Stability of Electric Power Systems," Massachusetts, USA: Kluwer Academic Publishers, 1998.  
[2] P. Kundur, J. Paserba, V. Ajarapu, G. Andersson, A. Bose, C. Canizares, N. Hatziairgiou, D. Hill, A. Stankovic, C. Taylor, T. Van Cutsem and V. Vittal, "Definition and classification of power system stability IEEE/CIGRE joint task force on stability terms and definitions," Power Systems, IEEE Trans. vol. 19, pp. 1387 – 1401, 2004.  
[3] H. H. Goh, Q. S. Chua, S. W. Lee, B. C. Kok, K. C. Goh, K. T. K. Teo, "Comparative Study of Line Voltage Stability Indices for Voltage Collapse Forecasting in Power Transmission System," International

Journal of Electrical, Computer, Electronics and Communication Engineering, vol. 9, no. 2, pp. 132-137, 2015.  
[4] Hsiao-Dong Chiang, Ian Dobson, Robert J. Thomas, James S. Thorp and Lazhar Fekih-Ahmad, "On Voltage Collapse in Electric Power Systems," IEEE Trans. on Power Systems, vol. 5, no. 2, May1990.  
[5] P. A. Lof, T. Smed, G. Anderson and D. J. Hill, "Fast calculation of a voltage stability index," IEEE Trans. on Power Systems, vol. 7, no. 1, pp. 54-64, February 1992.  
[6] P.A. Lof, G. Anderson and D.J. Hill, "Voltage stability indices for stressed power systems," IEEE Trans. Power Syst.8, (1), pp. 326-335, February 1993.  
[7] C. A. Canizares, A. C. Z. de Souza and V. H. Quintana, "Comparison of performance indices for detection of proximity to voltage collapse," IEEE Trans. on Power Systems, vol. 11, no. 3, pp. 1441-1450, August 1996.  
[8] I. Musirin, T.K.A. Rahman, "Estimating Maximum Loadability for Weak Bus Identification Using FVSI," IEEE Power Engineering Review, pp. 50-52, November 2002.  
[9] I. Musirin, T.K.A. Rahman, "Novel Fast Voltage Stability Index (FVSI) for Voltage Stability Analysis in Power Transmission System," 2002 Student Conference on Research and Development Proceedings, Shah Alam, Malaysia, pp. 265-268, July 2002.  
[10] M. Moghavvemi, F.M. Omar, "Technique for Contingency Monitoring and Voltage Collapse Prediction," IEEE Proceeding on Generation, Transmission and Distribution, vol. 145, pp. 634-640, November 1998.  
[11] M.V. Suganyadevi, C.K. Babulal, "Estimating of Loadability Margin of a Power System by comparing Voltage Stability Indices," International Conference on Control, Automation, Communication and Energy Conservation, pp.1-4, June-2009.  
[12] A. Kazemi, V. Vahidinasab, A. Mosallanejad, "Study of STATCOM and UPFC Controllers for Voltage Stability Evaluated by Saddle-Node Bifurcation Analysis," First International Power and Energy Conference PECon-2006, pp.191-195, November 28-29, 2006.  
[13] Aniruddha Ray, Prof. Jayalakshmi. O. Chandle, "Voltage Stability Enhancement during Excess Load Increments through Optimal Location of UPFC Devices," IEEE International Conference on Technological Advancements in Power & Energy, pp. 443-448, 2015.

- [14] J. Lakkireddy, R. Rastgoufard, I. Leevongwat and P. Rastgoufard, "Steady State Voltage Stability Enhancement Using Shunt and Series FACTS Devices," IEEE-2015
- [15] Federico Milano, "An Open Source Power System Analysis Toolbox," IEEE Transaction on Power Systems, vol. 20, no. 3, pp.1199-1206, August 2005.
- [16] Milano F., Power System Analysis Toolbox Documentation for PSAT version 2.1.8., <http://thunderbox.uwaterloo.ca/~fmilano>, (2006).