

Obtaining Constants of Johnson-Cook Material Model Using a Combined Experimental, Numerical Simulation and Optimization Method

F. Rahimi Dehgolan, M. Behzadi, J. Fathi Sola

Abstract—In this article, the Johnson-Cook material model's constants for structural steel ST.37 have been determined by a method which integrates experimental tests, numerical simulation, and optimization. In the first step, a quasi-static test was carried out on a plain specimen. Next, the constants were calculated for it by minimizing the difference between the results acquired from the experiment and numerical simulation. Then, a quasi-static tension test was performed on three notched specimens with different notch radii. At last, in order to verify the results, they were used in numerical simulation of notched specimens and it was observed that experimental and simulation results are in good agreement. Changing the diameter size of the plain specimen in the necking area was set as the objective function in the optimization step. For final validation of the proposed method, diameter variation was considered as a parameter and its sensitivity to a change in any of the model constants was examined and the results were completely corroborating.

Keywords—Constants, Johnson-Cook material model, notched specimens, quasi-static test, sensitivity.

I. INTRODUCTION

THERE are numerous material models to estimate the stress-strain curve in plastic region. Most of these models have been obtained by experiments and each model gives different constants for various materials. To obtain these constants in earlier methods, experiments were designed in three groups to consider the effect of work hardening, strain rate and temperature. However, experiments are always expensive and time consuming and their results are not always reliable which can be due to the type of the testing machine, difficulty of performing the procedures under constant strain rate almost in all testing machines and the need for using sophisticated instrumentation, etc. [1]-[4]. Benallal and Berstad [5] used experimental data and optimization methods to calculate the model constants. Their experiments were done under three different strain rates and three different temperatures. In another study, Zhao and Lee [6] used a similar method to determine the work hardening behaviour of the material (isotropic or kinematic). In their work, specimens

were put under tension and pressure using three point bending test method. Recently, combined methods such as numerical simulation plus optimization, are used to obtain the constants of material models. For example, Sasso et al. [7] used Hopkinson pressure bar to carry out their experiments and then numerically simulated their process. They used specimens with three different lengths and considered the temperature variation due to plastic deformation to make the results more accurate. In another study, Majzoobi et al. [8] used a combined experimental, numerical, and optimization technique to determine the constants of Zerilli-Armstrong material model. In another research, Majzoobi and Rahimi Dehgolan [9] used the same method but this time to obtain the constants of Johnson-Cook damage model. They used the diameter decreasing as the objective function in optimization. In this study, static constants of Johnson-Cook material model for a plain specimen of structural steel, ST.37, have been obtained by using an experimental, numerical simulation and optimization method. In optimization process, easily measurable geometrical parameters were used to define the objective function. To validate the procedure, obtained material model constants were used to numerically simulate a simple tension test performed on three notched specimens with three different notch radii.

II. EFFECTIVE PARAMETERS ON MATERIAL BEHAVIOR

Stress-strain behaviour of materials in plastic region is generally affected by three parameters: strain, strain rate, and temperature. Plastic deformation is an irreversible process which means that the behaviour of a material under specified stress and strain is influenced by deformation history in addition to the three parameters mentioned before (1):

$$\sigma = f(\varepsilon, \dot{\varepsilon}, T, \text{Deformation history}) \quad (1)$$

Under low and fixed strain rates, metals show work hardening behaviour, meaning that strength of the material increases by increasing the strain value. This phenomenon can be formulated by (2):

$$\sigma = \sigma_0 + k\varepsilon^n \quad (2)$$

where σ_0 is the yield stress, k is the coefficient of work hardening, and n represents the work hardening's power. Metals usually show different behaviour under various strain

F. Rahimi Dehgolan was with the Turbotec-co, Tehran, Iran (corresponding author, phone: 98912-8351163; e-mail: f.rahimi.dehgolaan@gmail.com).

M. Behzadi is with Turbotec-co, Tehran, Iran (e-mail: mhn.behzadi@gmail.com).

J. Fathi Sola is with the Mechanical Engineering Department, University of Texas at Arlington, Arlington, TX 76019 USA (e-mail: jalal.fathisola@mavs.uta.edu).

rates. Effect of strain rate on stress is shown by (3). However, it is not valid for high strain rates.

$$\sigma \propto \ln \dot{\epsilon} \quad (3)$$

Most of the energy in a plastic deformation is transformed into heat. In dynamic deformations, not enough time is usually available for heat transfer between the specimen and environment which ends in increasing the temperature of the specimen. The temperature increment can be calculated by (4):

$$\Delta T = \frac{\int \sigma d\epsilon}{\rho C_p} \quad (4)$$

where ΔT is temperatures increase, ρ is density, and C_p is specific heat. Effect of temperature on stress is formulated as (5):

$$\sigma = \sigma_r \left[1 - \left(\frac{T - T_r}{T_{melt} - T_r} \right)^m \right] \quad (5)$$

where T_{melt} and T are melting and environment temperatures, T_r is reference temperature used to obtain σ_r , and m is an experimental parameter.

III. REVIEW OF SOME WELL-KNOWN MATERIAL MODELS

A. Power Law Model

This model which is defined by (6) only includes the effect of strain rate but the coefficients can be considered as a function of temperature.

$$\sigma = k \epsilon^n \dot{\epsilon}^m \quad (6)$$

B. Zerillie-Armstrong Model

Zerillie and Armstrong [10] presented equations to model

the behaviour of materials with FCC (Face Centered Cubic) and BCC (Body Centered Cubic) crystal structures. These equations are given in (7) and (8):

$$\sigma = C_1 + C_2 \exp(-C_3 T + C_4 \ln \dot{\epsilon}) + C_5 \epsilon^n \text{ for BCC} \quad (7)$$

$$\sigma = C_1 + C_2 \sqrt{\epsilon} \exp(-C_3 T + C_4 \ln \dot{\epsilon}) \text{ for FCC} \quad (8)$$

where C_1 is to consider the effect of residual stress, C_2 is used for curve fitting, C_3 and C_4 are the coefficients of thermal softening and strain rate, respectively. Also C_5 and n are to account the strain hardening behaviour of the BCC metals.

C. Johnson-Cook Model

Johnson and Cook [11] presented (9) to model the behaviour of material considering the influence of work hardening, strain rate and temperature.

$$\sigma = (A + B \epsilon^n) \left(1 + C \ln \frac{\dot{\epsilon}}{\dot{\epsilon}_0} \right) \left[1 - (T^*)^m \right] \quad (9)$$

where A and B are strain hardening coefficients, C is non-dimensional sensitivity coefficient of strain rate, m and n represent power of thermal softening and strain hardening respectively and T^* is defined by (10).

$$T^* = \left(\frac{T - T_r}{T_{melt} - T_r} \right) \quad (10)$$

IV. EXPERIMENTS

A. Experimental Procedure

In this study, quasi-static tension tests were done on one plain and three notched specimens by using an Instron tensile testing machine. Specimens were chosen according to ASTM standard (Fig. 1).

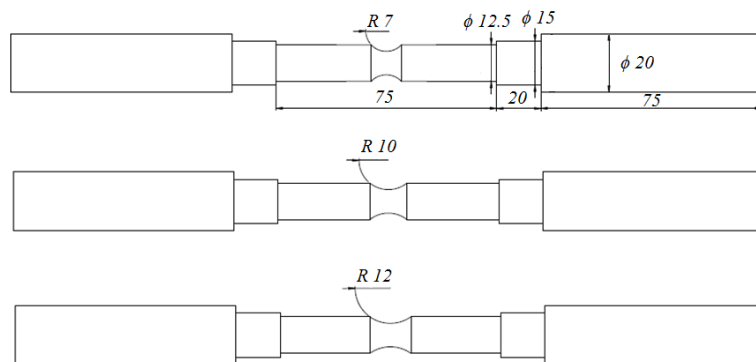

Fig. 1 Geometrical specification of notched specimens (in millimeter)

Tension test of plain specimens was carried out by using an extensometer of 50 millimeters long. Since for a plain specimen, the location where necking begins, depends on the location where structural faults are concentrated and cannot be determined before the experiment, the extensometer was set in

a position symmetric with respect to the center of specimen. However, in notched specimens, plastic deformation is concentrated at the location of the notch and displacement at two ends of specimen after fracture is much less than the plain specimen, therefore the tension tests of notched specimens

were done by using an extensometer of 25 millimeters long. Fig. 2 shows the extensometer set on the plain specimen during the tension test.



Fig. 2 Extensometer set on the plain specimen during the tension test

B. Experimental Result

Experimental result obtained from the notched specimens validates that increasing the notch radius increases time to fracture, which is due to strain rate reduction caused by a slight increase in the length of the specimen. Furthermore, it has been shown that increasing the notch radius decreases the force to fracture, which is due to the inverse proportionality of strain rate and notch radius. Table I includes experimental result after ultimate fracture.

TABLE I
 EXPERIMENTAL RESULT AFTER ULTIMATE FRACTURE

Type of specimen	Time to fracture (S)	Final displacement at two ends (mm)	Maximum force to fracture (N)	Diameter reduction at fracture location (mm)
Plain	121.8	10.15	94156.6	3.10
notched R=7	38.3	3.19	44981.2	0.87
Notched R=10	39.05	3.25	43110.1	1.32
Notched R=12	41.14	3.42	42690.0	1.44

V. DERIVING THE CONSTANTS

A. Defining an Objective Function

In this paper, a combined experimental, numerical simulation, and optimization method has been used to obtain the constants of Johnson-Cook material model. At first, a quasi-static tension test was carried out on a specimen by using an Instron tensile testing machine. In order to obtain the constants, the value of fracture strain which is needed can be calculated by accurately measuring the minimum fracture diameter to be used in (11):

$$\varepsilon_f = 2Ln \frac{d_0}{d_f} \quad (11)$$

where d_0 is the initial diameter, and d_f is the diameter measured after fracture. Necking diameter was chosen as the optimization parameter since it is the only parameter that the value of fracture strain depends on. Therefore, in order to determine the constants, an objective function was defined to minimize the difference between the experimental

measurements and simulation results obtained for necking diameter (12):

$$OBJ = d_{\text{experimental}} - d_{\text{numerical}} \quad (12)$$

For defining the objective function on the basis of material model constants used in simulation, it is approximated by a polynomial of second order as (13):

$$OBJ(x) = a_0 + \sum_{i=1}^n a_i x_i + \sum_{i=1, j=1}^n b_{ij} x_i x_j \quad (13)$$

where x_i is the design parameter (constant of material model), n is the number of design parameters and a_0 , a_i and b_{ij} are the coefficients of the objective function. The number of equations required to be solved in order to obtain these coefficients, equals to the number of polynomial coefficients. The equations usually come from numerical simulation with different values for material model constants. In this paper it is intended to obtain the first three material parameters of Johnson-Cook relation (A , B and n), shown as x_1 , x_2 and x_3 in the objective function. Expanding the polynomial for these parameters we have (14)

$$OBJ(x) = a_0 + a_1 x_1 + a_2 x_2 + a_3 x_3 + a_4 x_1^2 + a_5 x_2^2 + a_6 x_3^2 + a_7 x_1 x_2 + a_8 x_1 x_3 + a_9 x_2 x_3 \quad (14)$$

The above equation has 10 coefficients therefore 10 equations are required to calculate the coefficients. As mentioned before these equations come from numerical simulation with different values for material model constants. So experiments were simulated using finite element. Table II shows the results from simulation with 10 different sets of material model constants. By solving the equations, the objective function is rewritten as (15)

$$OBJ(x) = 90.828 + 2.698 e12 x_1 - 5.366 e12 x_2 - 7.245 x_3 + 0.0001 x_1^2 + 0.0013 x_2^2 - 116.15 x_3^2 + 6.58 e - 5 x_1 x_2 + 7.101 e12 x_1 x_3 + 1.420 e13 x_2 x_3 \quad (15)$$

B. Using Genetic Algorithm

In the next step, the objective function was optimized using GA (Genetic Algorithm). The GA is the most widely used optimization method to tackle engineering problems. The GA was popularized by Holland [12] and has emerged as a global search method to simulate the evolution in complex physical and biological systems. At each iteration, GA generates a population of points that approach the optimal solution by using stochastic and not deterministic operators. It starts by initializing a set of individuals that form the first population. Then, the first population is submitted to genetic operators, resulting in the evolution of populations through generations (iteration cycles). In each generation, the best individuals are chosen by evaluation according to the objective function. The individuals that are selected as better, have a higher possibility

of being included in the recombination procedure. Mutation, which periodically changes the parts of individuals, is the main operator to protect the algorithm from permanently losing genetic material through the evolution of generations. Crossover is used for the recombination of genetic exchange between individuals. Another operator is migration which is

the movement of individuals among sub-populations of existing individuals, with the best individuals from one sub-population replacing the worst individuals in another sub-population. GA proposes the best individual as the solution to the problem. A flowchart of a basic GA is shown in Fig. 3.

TABLE II
 REDUCED DIAMETER OBTAINED FROM SIMULATION WITH 10 DIFFERENT SETS OF CONSTANTS

(A,B,n)	Reduced diameter	Obj.	(A,B,n)	Reduced diameter	Obj.
390,200,0.38	3.130818333	0.033818	410,205,0.37	3.178673333	0.081673
390,210,0.38	2.958267143	-0.13873	410,205,0.38	3.2144525	0.117453
400,200,0.38	3.188548333	0.091548	410,205,0.39	3.204138333	0.13
400,200,0.385	3.18576	0.08876	410,200,0.38	3.27388	0.17688
405,200,0.38	3.259688333	0.11269	420,200,0.38	3.379681667	0.2

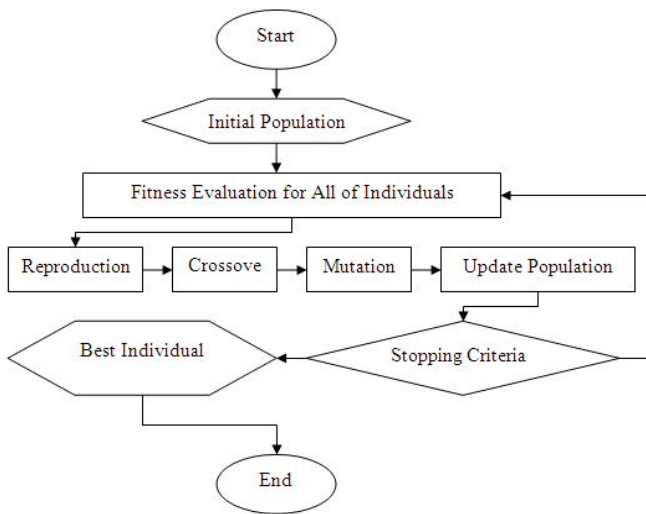

Fig. 3 Flowchart of a basic GA [12]

C. Results

Final values obtained for Johnson-Cook material models constants (A , B and n) are 380, 187.7, and 0.38, respectively. The result of plain experiments was used to drive constants. The calculated A , B , and n were used to simulate the experiments done for plain specimens in Ls-Dyna and the result for diameter reduction was completely reasonable. Fig. 4 shows the necking regions obtained after experiments and simulations for plain specimens. Finally, these constants were used to simulate the experiments done for the notched specimens. Fig. 5 shows the necking regions obtained after experiments and simulation for the notched specimens. Also, stress-strain curves from experiments and simulation have been compared in Figs. 6-8. Table III compares between the values obtained for diameter reduction from experimental process and simulation.

VI. SENSITIVITY ANALYSIS

In this study, variations of geometrical parameters resulted from utilizing different material model constants in simulation were used to derive the Johnson-Cook material model constants. In order to validate the method, sensitivity of diameter increment (Δd) toward variations of obtained

constants, A , B , and n was investigated and the results were illustrated in Figs. 9-11.

It can be seen that changing the value of each Johnson-Cook material model constants varies the value of Δd considerably. Therefore, it is acceptable to use diameter increment (Δd) as a parameter to obtain the constants. Fig. 12 shows percentage of variation in Δd parameter by exerting a 30% change in each of the three constants. It can be seen that Δd shows the maximum and minimum sensitivity toward A and n , respectively.

TABLE III
 COMPARES BETWEEN THE VALUES OBTAINED FOR DIAMETER REDUCTION FROM EXPERIMENTS AND SIMULATIONS

Type of specimen	reduction in diameter obtained from experiment(mm)	reduction in diameter obtained from simulation(mm)	Error %
R=7	0.87	0.90	3.4483
R=10	1.32	1.27	3.7879
R=12	1.44	1.41	2.0833

VII. CONCLUSION

In this study, the constants of Johnson-Cook material model for a plain specimen of structural steel ST.37 were obtained by using a combined experimental, numerical simulation, and optimization method. It was shown that these constants could be used to simulate the tension behaviour of notched specimen. Calculation process started with a quasi-static tension test done for a plain specimen. After simulating the test, a second degree polynomial error function was defined as the difference between experimental measurement and numerical simulation results of fracture diameter and optimized by using genetic algorithm. Then, simple tension tests were done on three notched specimens with different notch radii, and by using the constants obtained for plain specimen experiment, tension tests for notched specimens were numerically simulated. Results from experiments and numerical simulation were in good agreement. Finally, a sensitivity analysis was performed to confirm the method used in this paper which is validated by using diameter increment (Δd) as a parameter to obtain the constants, and it was shown that the diameter increment (Δd) is considerably sensitive to changing the A constant.

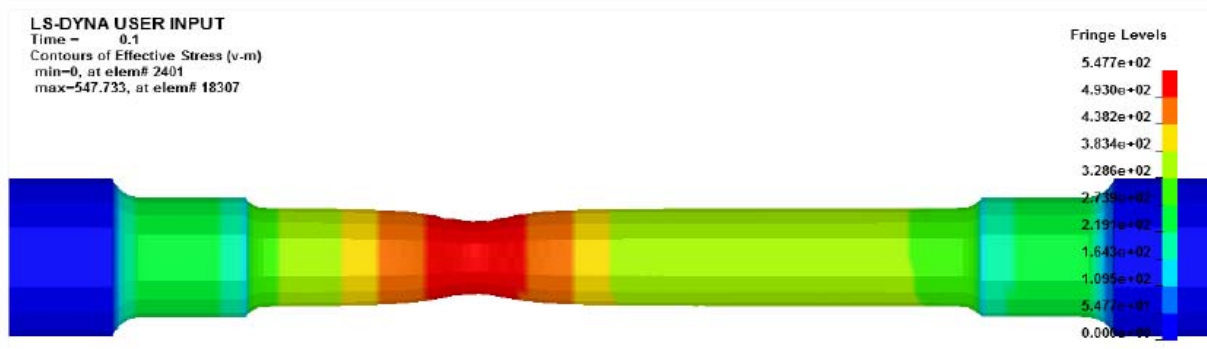
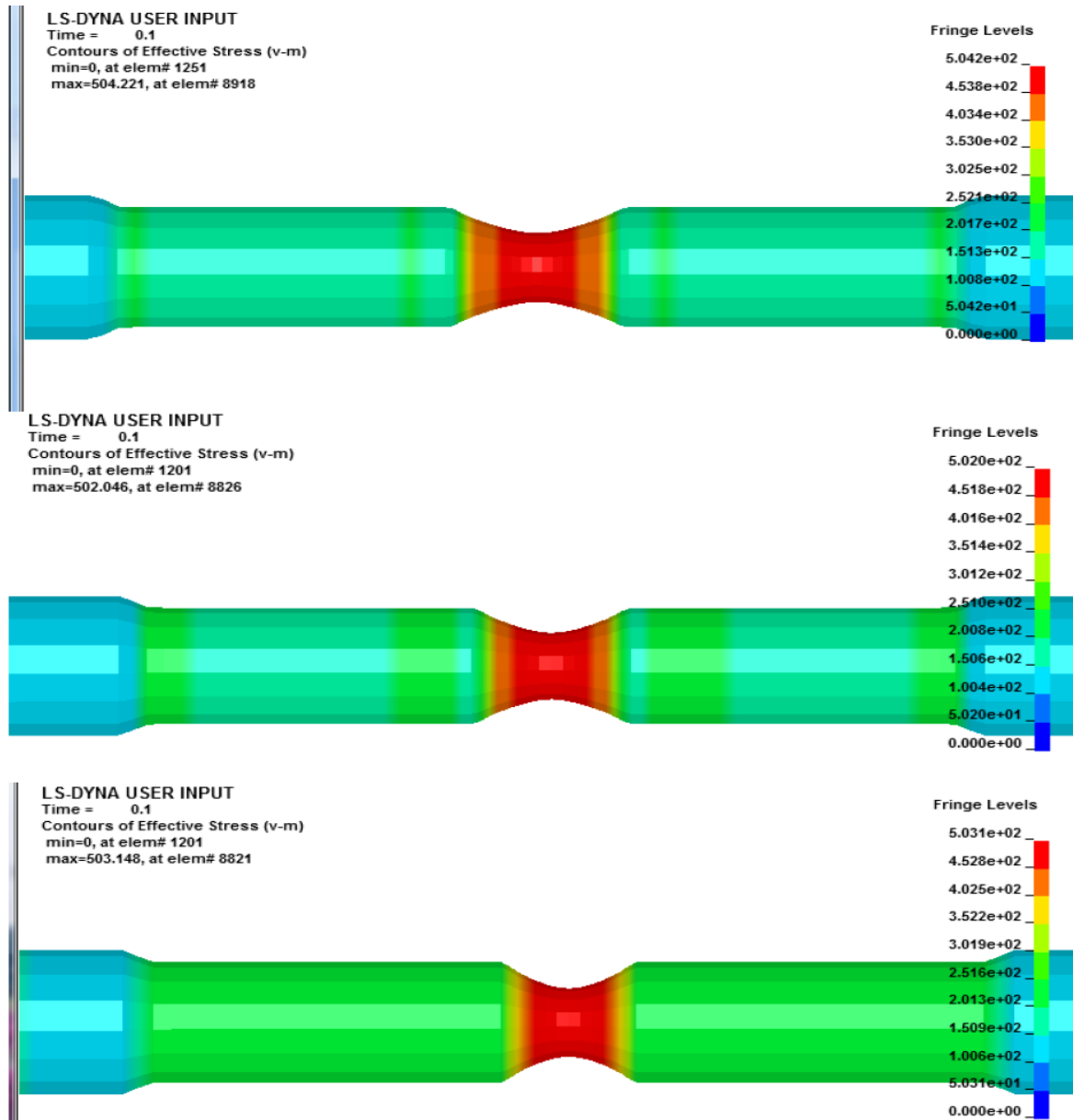

Fig. 4 Necking regions obtained after experiments and simulations for plain specimens



(a)



(b)

Fig. 5 Comparing the necking regions obtained after experiments and simulations for notched specimens

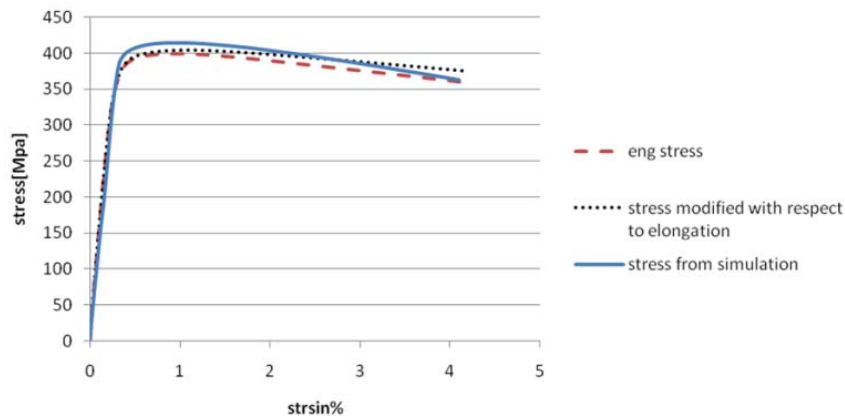

Fig. 6 Stress-strain curves obtained from experiments and simulations for notched specimen $r=7$ mm

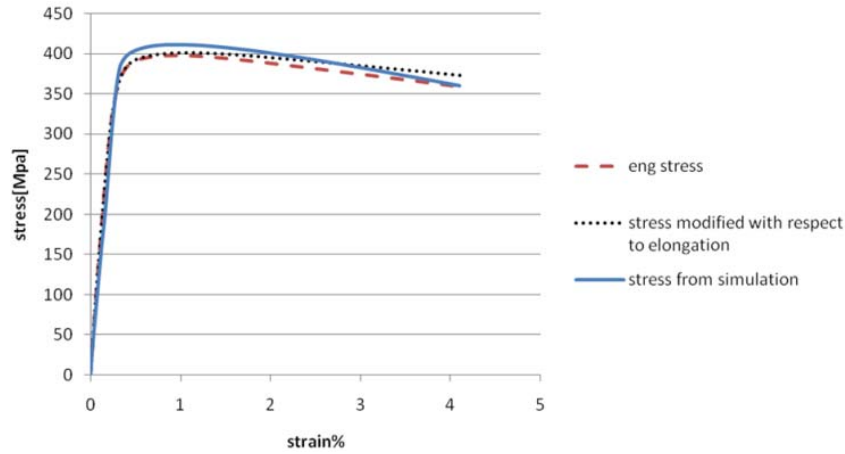

Fig. 7 Stress-strain curves obtained from experiments and simulations for notched specimen $r=10\text{mm}$

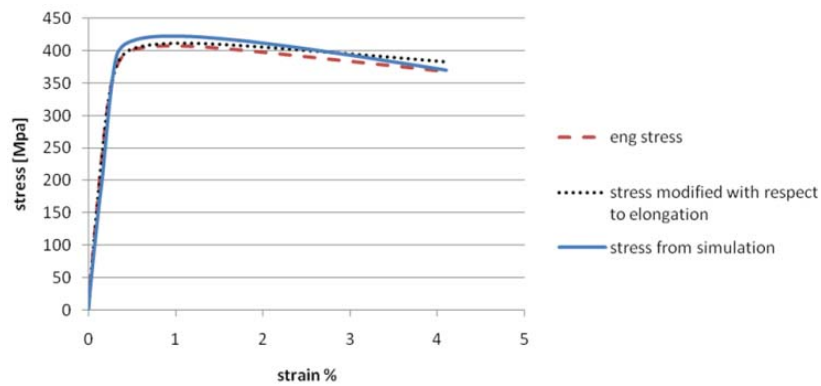

Fig. 8 Stress-strain curves obtained from experiments and simulations for notched specimen $r=12\text{mm}$

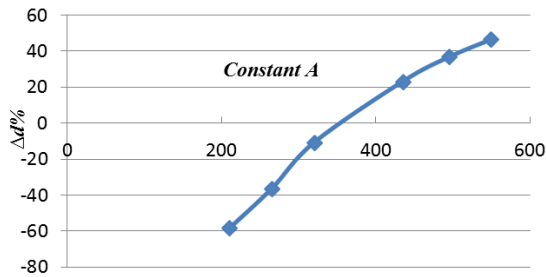

Fig. 9 Sensitivity of Δd (in percent) toward constant A

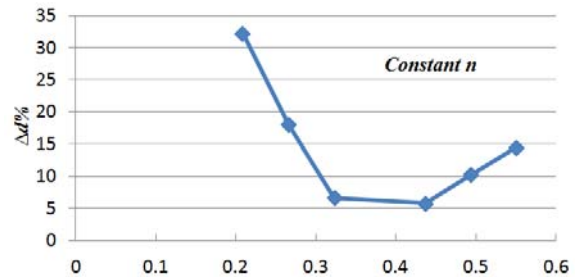

Fig. 11 Sensitivity of Δd (in percent) toward constant n

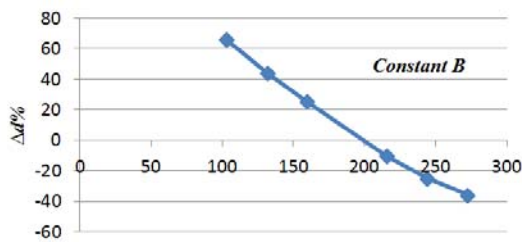

Fig. 10 Sensitivity of Δd (in percent) toward constant B

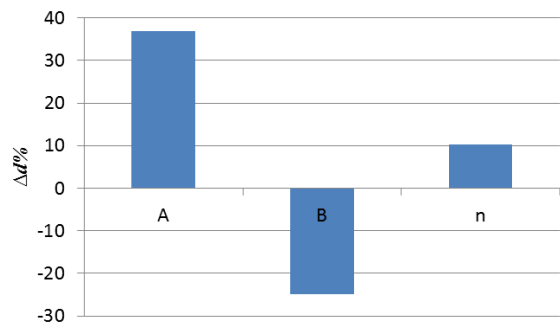

Fig. 12 Variation in Δd (in percent) parameter by exerting a 30 percent change in A, B, and n

REFERENCES

- [1] C. J. Maiden and S. J. Green, Compressive strain-rate tests on six selected materials at strain rates from 10^{-5} to 10^5 s^{-1} , *Journal of applied mechanics*, Vol. 33 1966 pp. 4961-4970.
- [2] U. S. Lindholm, A. Nagy, G. R. Johnson and J. M. Hoegfeldt, Large Strain, High Strain Rate Testing of Copper, *J. Eng. Mater. Technol* 102(4), 376-381 Oct. 1980.
- [3] F. E. Hauser, Techniques for measuring stress-strain relations at high strain rates, *Exp. Mech.*, 1966 pp. 395-402.
- [4] A. Nadia and M. J. Manjoine, High speed tension tests at elevated temperature-Part I and II, *Trans. ASME*, 1941 63, A77.
- [5] A. Benallal, T. Berstad, An experimental and numerical investigation of the behaviour of AA5083 aluminium alloy in presence of the Portevin-Le Chatelier effect, *International Journal of Plasticity* 24 2008 1916-1945.
- [6] K. M. Zhao, J.K. Lee, finite element analysis of the three-point sheet metals, *Journal of material processing technology*, 122 2002 6-11.
- [7] M. Sasso, G. Newaz, and D. Amodio, Material characterization at high strain rate by Hopkinson bar tests and finite element optimization, *Journal Materials Science and Engineering A* 487 2008 289-300.
- [8] G. H. Majzoobi, S. F. Z. Khosroshahi, H. B. Mohammadloo, Determination of the Constants of Zerilli-Armstrong Constitutive Relation Using Genetic Algorithm, *Advanced Materials Research*, Vols. 264-265, pp. 862-870, Jun. 2011.
- [9] G. H. Majzoobi, F. Rahimi Dehgolan, Determination of the constants of damage models, *Procedia Engineering* 10 2011 764-773.
- [10] F. J. Zerilli and R. W. Armstrong, Dislocation-mechanics-based constitutive relation for material dynamic calculation, *journal of applied physics*, Vol. 61. 1987 pp 1816-1825.
- [11] G. R. Johnson, W. H. Cook, Fracture characteristics of three metals subjected to various strains, strain rates, temperatures and pressure, *EngngFractMech*, Vol. 21(1) 1985 pp. 31-48.
- [12] J. H. Holland, *Adaptation in Natural and Artificial Systems*, University of Michigan Press, Ann Arbor, Michigan, USA 1975.