

The Improvement of Environmental Protection through Motor Vehicle Noise Abatement

Z. Jovanovic, Z. Masonicic, S. Dragutinovic, Z. Sakota

Abstract—In this paper, a methodology for noise reduction of motor vehicles in use is presented. The methodology relies on synergic model of noise generation as a function of time. The arbitrary number of motor vehicle noise sources act in concert yielding the generation of the overall noise level of motor vehicle thereafter. The number of noise sources participating in the overall noise level of motor vehicle is subjected to the constraint of the calculation of the acoustic potential of each noise source under consideration. It is the prerequisite condition for the calculation of the acoustic potential of the whole vehicle. The recast form of pertinent set of equations describing the synergic model is laid down and solved by dint of Gauss method. The bunch of results emerged and some of them i.e. those ensuing from model application to MDD FAP Priboj motor vehicle in use are particularly elucidated.

Keywords—Noise abatement, MV noise sources, noise source identification, muffler.

I. INTRODUCTION

THE overall external noise emission of motor vehicles having at least four wheels is subjected to stringent limits dictated by amendments of ECE Regulation No. 51 [1] in force. No problems are encountered in the case when these limits are complied with. On the contrary, in the case when these limits are exceeded, in lieu of the fact that, generally speaking, the measurement of noise emission pursuant to this regulation is quite simple, a lot of difficulties related to noise source identification and reduction are encountered due to non-stationary test procedure (acceleration) provided in the regulation above [2]. Namely, during acceleration test, engine noise is very close to its maximum value while the noise generated by some other sources, particularly in the case of commercial vehicles, is far away from it yielding variable, time dependent noise source participation in the overall motor vehicle noise emission thereafter. Such a situation requires the entirely new methodology for noise reduction of motor vehicle in use and this one is proposed in the text below.

II. EXPLANATION OF A PARTICULAR METHODOLOGY

Particular methodology for noise reduction of motor vehicle in use consists of:

A. The motor vehicle noise source identification on the basis of both experimental and numerical techniques.

Zoran Jovanovic, Zoran Masonicic, Sinisa Dragutinovic, and Zeljko Sakota are with the University of Belgrade, Institute of Nuclear Sciences "VINČA", Laboratory for IC Engines and Motor Vehicles, Belgrade, Serbia (e-mail: zoranj@vinca.rs, masonicicz@vinca.rs, sdragutinovic@gmail.com, sakota@vinca.rs).

- B. the calculation of acoustic efficiency of various aggregates and components representing dominant noise sources (for instance, engine noise is modulated by each muffler design).
- C. The calculation of acoustic potential for a particular motor vehicle noise source.
- D. The application of synergic model for external motor vehicle noise generation in order to calculate time-dependent distribution of overall noise on particular sources.
- E. Definition of the required motor vehicle noise (allowed limits for various categories of vehicles).
- F. The mutual interrelationship between numerical values of absolute noise source attenuation and qualitative interventions.
- G. The mutual interrelationship between numerical values of relative noise source attenuation and qualitative intervention.
- H. Calculation of all possible sets (combinations) of simultaneous interventions on noise sources with their effect onto overall external motor vehicle noise (increment = 1 dB).
- I. Calculation of all possible sets (combinations) of simultaneous interventions on noise sources yielding the required motor vehicle noise (limits) (increment = 1 dB).
- J. Calculation of acoustic potential of the whole vehicle (each noise source level reduced to the extent of its corresponding acoustic potential).
- K. On the basis of cost-benefit analysis the selection of optimal set (combination) of simultaneous interventions on noise sources yielding the achievement of the required external motor vehicle noise level mentioned in E.

The basis of a particular methodology is point D i.e. synergic model of motor vehicle noise generation depicted in Fig. 1.

Synergic model considers intake and exhaust system together with the engine therefore the time-dependent external noise of the basic vehicle configuration, obtained by dint of spectrum integration, encompasses noise emitted through engine surface, modulated noise of intake and exhaust system, cooling system noise and, in its simplest form, the noise of all other sources together (transmission, final differential gear, rolling noise etc.). In lieu of the fact that a lot of pertinent equipment is available in Institute VINCA numerical operation with spectra is considered indispensable due to hypothetical ordinate damping on particular frequencies yielding the calculation of various coefficients of attenuation. Time-dependent external noise of all other vehicle

configurations is calculated in the same way. The simplest synergic model, in mathematical form, is presented as:

$$H_u(f,t)M_s(t) + M_s(t) + H_i(f,t)M_i(t) + M_v(t) + M_o(t) = B_1(t) \quad (1)$$

$$H_u(f,t)M_u(t) + M_s(t) + M_i(t) + M_v(t) + M_o(t) = B_2(t) \quad (2)$$

$$M_u(t) + M_s(t) + H_i(f,t)M_v(t) + M_v(t) + M_o(t) = B_3(t) \quad (3)$$

or alternatively in the case without both intake and exhaust system (4).

$$M_u(t) + M_s(t) + M_i(t) + M_v(t) + M_o(t) = B_3(t) \quad (4)$$

$$H_u(f,t)M_u(t) + M_s(t) + H_i(f,t)M_i(t) + H_v M_v(t) + M_o(t) = B_4(t) \quad (5)$$

$$H_u(f,t)M_u(t) + M_s(t) + H_i(f,t)M_i(t) + M_v(t) + H_o(f,t)M_o(t) = B_5(t) \quad (6)$$

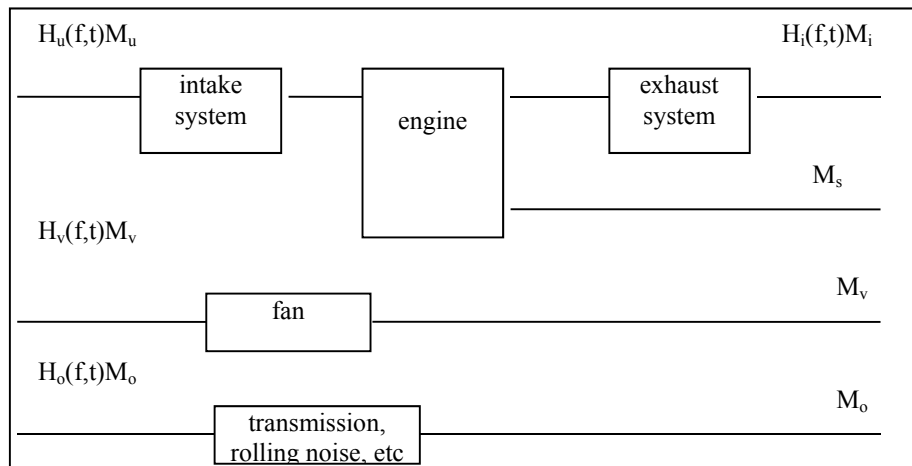

Fig. 1 Synergic model of motor vehicle noise generation

The mathematical form of expanded and more frequently used synergic model (designated as type 7 i.e. seven equations) is presented as:

$$H_u M_u + M_s + H_i M_i + M_T + M_D + M_V + M_P = B_1 \quad (7)$$

$$H_u M_u + M_s + M_i + M_T + M_D + M_V + M_P = B_2 \quad (8)$$

$$M_u + M_s + H_i M_i + M_T + M_D + M_V + M_P = B_3 \quad (9)$$

$$H_u M_u + M_s + H_i M_i + H_T M_T + M_D + M_V + M_P = B_4 \quad (10)$$

$$H_u M_u + M_s + H_i M_i + M_T + H_D M_D + M_V + M_P = B_5 \quad (11)$$

$$H_u M_u + M_s + H_i M_i + M_T + M_D + H_V M_V + M_P = B_6 \quad (12)$$

$$H_u M_u + H_S M_s + H_i M_i + M_T + M_D + H_V M_V + M_P = B_7 \quad (13)$$

i.e. in matrix form:

$$\begin{bmatrix} A_1 & 1 & A_3 & 1 & 1 & 1 & 1 \\ A_1 & 1 & 1 & 1 & 1 & 1 & 1 \\ 1 & 1 & A_3 & 1 & 1 & 1 & 1 \\ A_1 & 1 & A_3 & A_4 & 1 & 1 & 1 \\ A_1 & 1 & A_3 & 1 & A_5 & 1 & 1 \\ A_1 & 1 & A_3 & 1 & 1 & A_6 & 1 \\ 0 & 0 & 0 & A_4 & A_5 & 0 & 1 \end{bmatrix} \begin{bmatrix} X_1 \\ X_2 \\ X_3 \\ X_4 \\ X_5 \\ X_6 \\ X_7 \end{bmatrix} = \begin{bmatrix} Y_1 \\ Y_2 \\ Y_3 \\ Y_4 \\ Y_5 \\ Y_6 \\ Y_7 \end{bmatrix} \quad (14)$$

where; H , A – coefficient of attenuation (subscript denotes particular noise source, i.e. u - means intake system, i - exhaust system, V - fan, D - differential gear, T - transmission, P - rolling noise, S - engine surface) M – non-modulated noise related to particular system B – intensity or acoustic pressure corresponding to the external noise of a particular motor vehicle configuration obtained by spectrum integration (subscript denotes particular motor vehicle configuration ranging from 1 to 7).

The first equation corresponds to the physical situation of basic vehicle configuration.

The second and third equations correspond to the cases with no intake and exhaust system respectively.

The fourth and fifth equations include cases with hypothetical numerical ordinate damping of transmission and final differential gear.

The sixth equation corresponds to the physical situation with partial or full enclosure of fan, while the seventh equation corresponds to the situation when the engine is switched off.

Equations (1)-(6) and (7)-(13) can be solved provided that coefficient matrix is known (calculated). The system is solved by method of factorization [3] (Sun Ultra Sparc II computer, OS Solaris, WorkShop 6.0 Fortran Compiler, Los Alamos CGS Graphyics System). All coefficients of independent variables are less or equal to 1. In the case of no muffler the coefficient adjacent to M_i is equal to 1 since there is no modulation of engine noise. Coefficient ranges from 0 dB ($H_i = 1$) to full attenuation when $H_i M_i = 1$.

III. NUMERICAL RESULTS

New approach is successfully applied to a large number of trucks (FAP1318, FAP 1835, FAP2023 and FAP2629) and busses (A537, A637, A747, A547 and A559) manufactured by DOO FAP Priboj. Matrix of attenuation coefficients is determined either by homomorphic acoustic pressure signal processing such as in the case of intake/exhaust system [4], [5] or by hypothetical ordinate damping elsewhere. In the case of articulated low-floor city bus, designated as A559.4 (MAN D2066 LUH 12 engine, VOIGHT transmission, presented in Fig. 2), the prerequisite values necessary for the determination of coefficients H_u and H_i (these coefficients are obtained by dint of simple exponentiation with negative sign) are presented in Figs. 3 and 4.



Fig. 2 FAP A559.4 articulated low-floor city bus

The corresponding numerical values of minimal noise emissions of particular sources are presented below:

$$\begin{aligned}
 M_u &= 64,34 \text{ dB}, & M_S &= 70,13 \text{ dB}, & M_i &= 97,78 \text{ dB}, \\
 M_T &= 59,58 \text{ dB}, & M_D &= 67,15 \text{ dB}, & M_P &= 60,03 \text{ dB}, \\
 M_V &= 61,45 \text{ dB}
 \end{aligned}$$

The next step of the new approach is point G, i.e. the mutual interrelationship between numerical values of relative noise source attenuation and qualitative interventions. Namely, for the particular source such as intake system noise reduction of 0-1 dB means the optimization of its geometry, 1-2 dB means its redesign, while more than 2 dB means that it is out of its acoustic potential. On the contrary, in the case of exhaust system the noise reduction of 0-3 dB means the optimization of its geometry, 3-6 dB means serious redesign of geometrical components while more than 6 dB means the entirely new design of high performance mufflers.

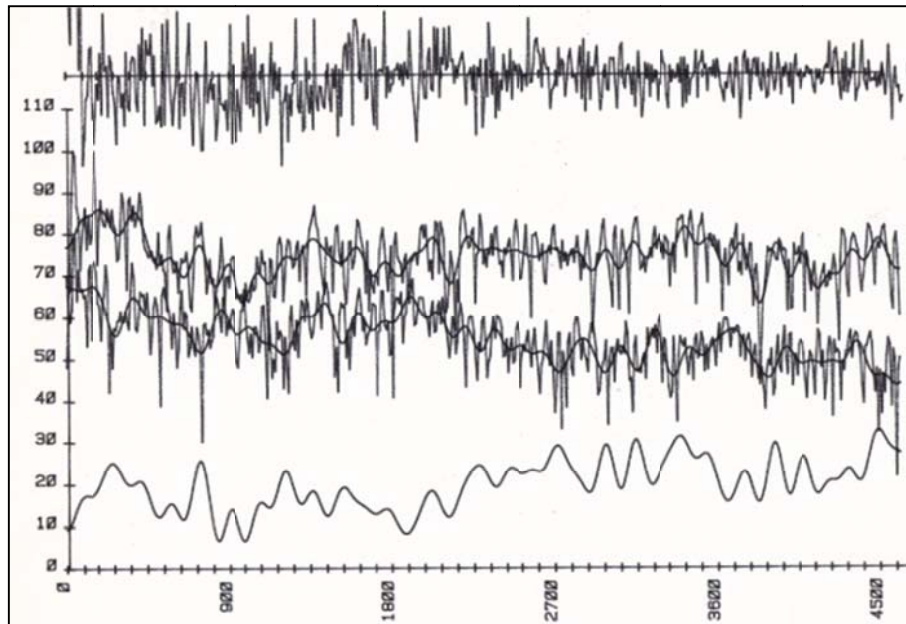

Fig. 3 The definition of coefficient H_i

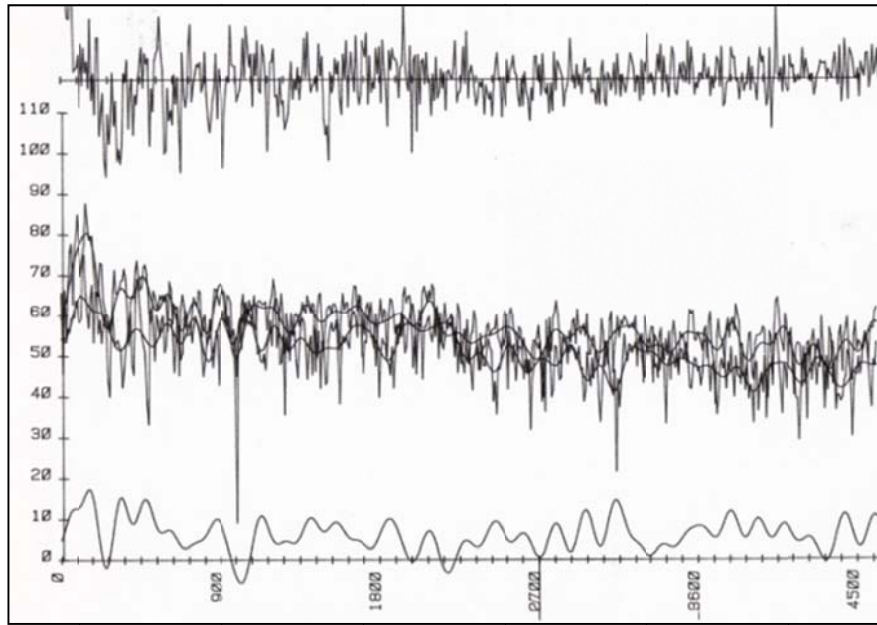

Fig. 4 The definition of coefficient H_u

In order to obtain all possible sets (combinations) of simultaneous interventions yielding the overall external motor vehicle noise within the limits prescribed by the relevant regulation, relative noise reduction with increment of 1 dB for each source, in comparison with the existing one, is varied and the final effect calculated. In this way a bunch of combination satisfying the prescribed limit emerged and the optimal set selected pursuant to cost-benefit criteria. It was calculated that exactly 847 combinations of noise sources reductions (solutions) are available for the achievement of required external motor vehicle noise level in accordance with ECE Regulation No.51.

In order to define the optimal solution various combinations were analyzed into more details. Namely, some solutions such as (2, 7, 3, 2, 2, 2) and (2, 3, 7, 2, 2, 2) are fairly attractive due to fact that they require noise reduction of only one noise source. Sooth to say, certain drawbacks are encountered as well primarily due to demands as regards the quantum of corresponding noise reduction.

In the first case it means the application of highly effective noise absorbent materials in engine compartment while in the second case it means the average increase of exhaust system insertion loss of either 3-3.5 dB (relative value) or 19-19.5 dB (total value). In order to alleviate the problem, the third solution designated as (2, 9, 5, 2, 2, 2) was selected as an optimal one. Namely, it requires the simultaneous activity encompassing engine structure noise reduction of approximately 4 dB and relative average increase of exhaust system insertion loss in the whole frequency range of approximately 2 dB. The engine structure noise reduction of 4 dB is achievable by dint of close proximity shields, enclosures (partial, total) and particular barriers depending on the noise source and the level of noise reduction. In each case fairly subtle analysis as regards noise source sub-identification based

on coherence function determination due to combustion is prerequisite. In the case of articulated bus FAP A559 it was verified that the application of commercially available „two-layer“ panel with linear attenuation [10] in engine compartment is sufficient for required noise reduction. In its essence „two-layer“ panel is acoustic foam composed of polyester, lead barrier and mylar or tedlar coating (Fig. 5).

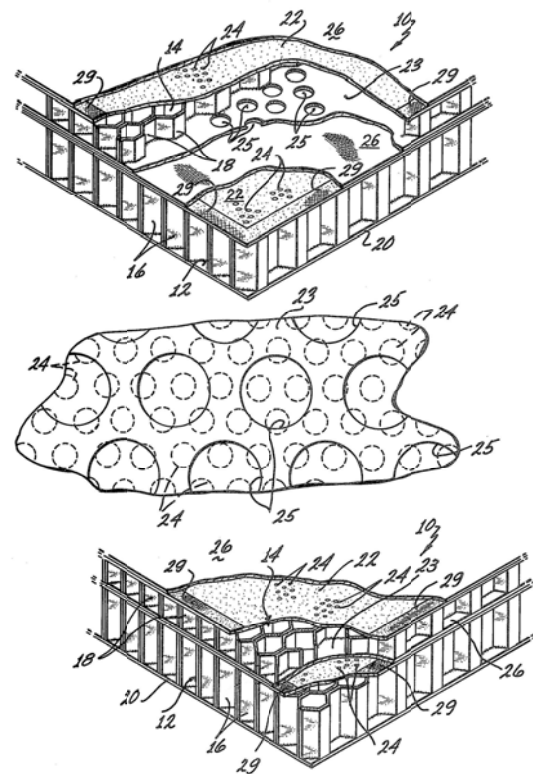

Fig. 5 Two-layer panel with linear attenuation

Obviously, two-layer panel structure is functioning on the Helmholtz resonator principle. The second requirement related to the increase of average total insertion loss from existing 17 to 19.5 dB is achieved through subtle redesign of acoustic elements on the basis of numerical calculations i.e. transfer matrix method [6]-[9]. Three different basic configurations of acoustic elements within the muffler laid down in Figs. 6-8 were considered.

Both geometry layout and dimensions were varied. After inordinately hard and numerous set of calculations it was found out that configuration of acoustic elements No.3 yields the average insertion loss in excess of 20 dB (Fig. 9). In this way the overall external noise level of articulated low-floor city bus FAP A559.4 is even lower than 80 dB(A).

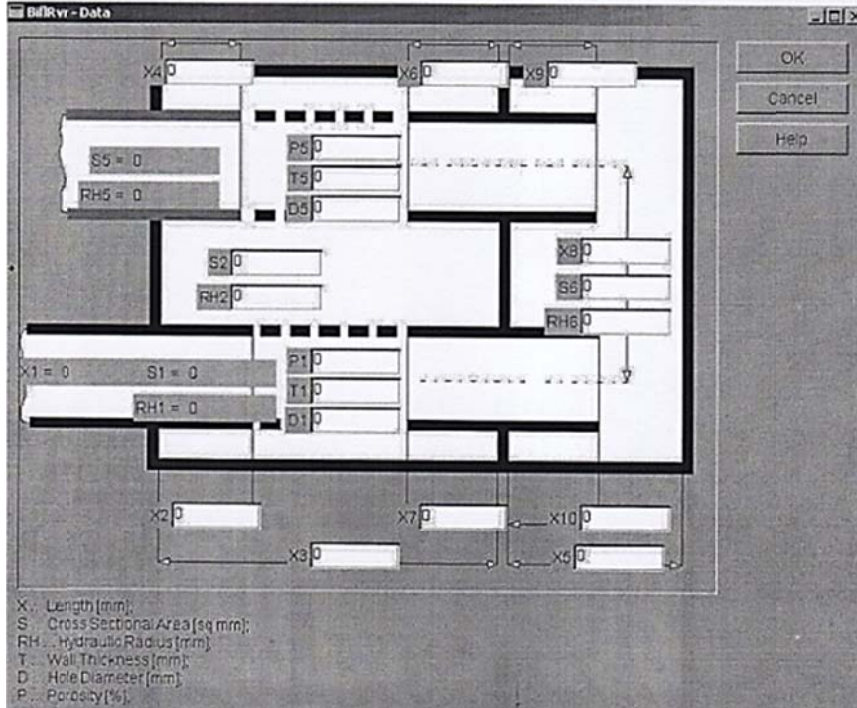

Fig. 6 Configuration of acoustic elements No.1

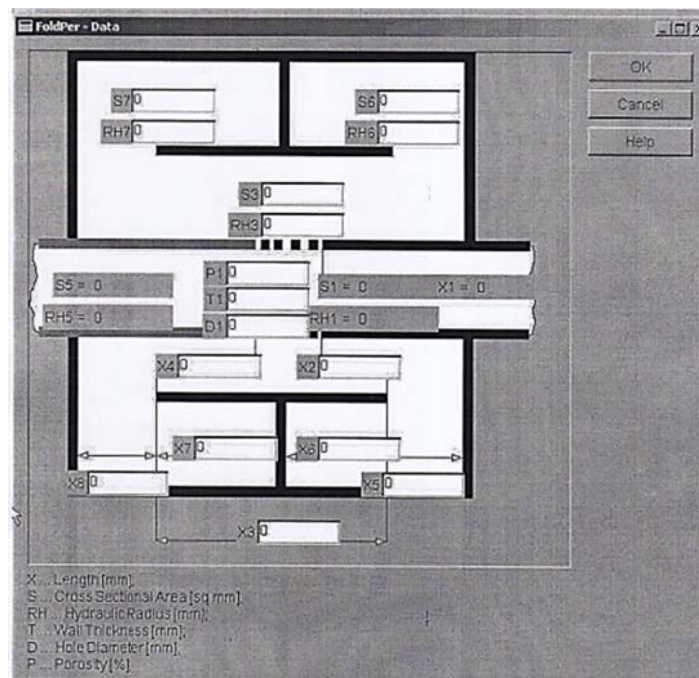

Fig. 7 Configuration of acoustic elements No.2

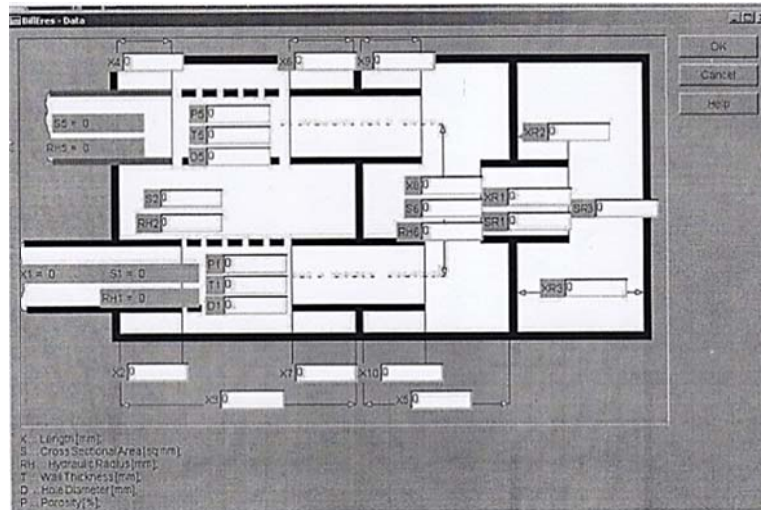

Fig. 8 Configuration of acoustic elements No.3

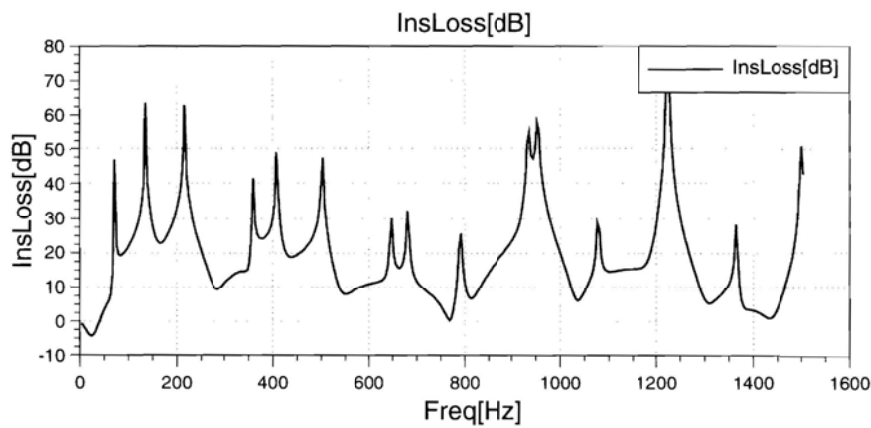

Fig. 9 Insertion loss corresponding to configuration of acoustic elements No.3

IV. CONCLUSIONS

The particular and fairly reliable methodology for the determination whether the overall external noise of any vehicle in use can be reduced to the required level and, if so, which set of qualitative and quantitative interventions on certain motor vehicle noise sources can be carried out in order to obtain the optimal set of small simultaneous interventions yielding the same effect as the radical and expensive one. The aforementioned method is successfully applied to articulated low floor city bus FAP A559.4.

REFERENCES

[1] "Uniform provisions concerning the approval of motor vehicles having at least four wheels with regard to their noise emissions", Regulation No.51, Proposal for amendments to the 03 series of amendments to Regulation No. 51, ECE/ TRANS/ WP29/ GRB/ 2015/ 3.
 [2] M. E. Brown, S. J. Walsh, J. L. Horner, R. Chuter, "Noise source characteristics in the ISO 362 vehicle pass-by noise test: Literature review", *Applied Acoustics*, 74 (2013), 1241-1265.
 [3] Z. Jovanović "The role of tensor calculus in multidimensional numerical modeling of combustion in reciprocating engines", Chapter IX, Hemisphere Publishing Corporation- New York, 1989, pp. 451-542, ISBN 0-89116-392-1.

[4] Z. Jovanović, Ž. Šakota, Z. Masoničić, S. Dragutinović, Z. Živanović "The motor vehicle exhaust and intake system characterization by dint of cepstrum analysis", XVI International Scientific-Technical Conference "TRANS&MOTOAUTO 09", September 17-19, 2009, Sea Resort Sunny Beach, Bulgaria, Proceedings, Volume I, ISSN 1313-5031, 11-14.
 [5] P.O.A.L. Davies, K.R. Holland "IC Engine Intake and Exhaust Noise Assessment", *Journal of Sound and Vibration* 223(3), (1999), 425-444.
 [6] AVL BOOST Version 2010.1, edition 03, part 4.17, Acoustic elements, 2010.
 [7] Min-Chie Chiu, Yung-Chun Chang "Shape optimization of multi-chamber cross-flow mufflers by SA optimization", *Journal of Sound and Vibration*, 312 (2008), 526-550.
 [8] Xiang Yu, Yuhui Tong, Yie Pan, Li Cheng "Sub-chamber optimization for silencer design", *Journal of Sound and Vibration*, 351 (2015), 57-67
 [9] Takashi Yasuda, Chaoqun Wu, Noritoshi Nakagawa, Kazuteru Nagamura "Studies on an automobile muffler with the acoustic characteristic of low-pass filter and Helmholtz resonator", *Applied Acoustics* 74 (2013) 49-57.
 [10] Z.Jovanovic, Z.Masonicic, Z.Sakota "Noise reduction of buses manufactured by FAP d.o.o.", Research project No.14039, Serbian Ministry of Education, Science and Technological Development, p.1-949, 2005-2008