

Design of Optimal Proportional Integral Derivative Attitude Controller for an Uncoupled Flexible Satellite Using Particle Swarm Optimization

Martha C. Orazulume, Jibril D. Jiya

Abstract—Flexible satellites are equipped with various appendages which vibrate under the influence of any excitation and make the attitude of the satellite to be unstable. Therefore, the system must be able to adjust to balance the effect of these appendages in order to point accurately and satisfactorily which is one of the most important problems in satellite design. Proportional Integral Derivative (PID) Controller is simple to design and computationally efficient to implement which is used to stabilize the effect of these flexible appendages. However, manual tuning of the PID is time consuming, waste energy and money. Particle Swarm Optimization (PSO) is used to tune the parameters of PID Controller. Simulation results obtained show that PSO tuned PID Controller is able to re-orient the spacecraft attitude as well as dampen the effect of mechanical resonance and yields better performance when compared with manually tuned PID Controller.

Keywords—Attitude control, flexible satellite, particle swarm optimization, PID controller.

I. INTRODUCTION

ATTITUDE of a satellite is the orientation the satellite occupies in space. It can be in form of attitude stabilization, that is the process of maintaining an existing orientation, or attitude maneuver control which is the process of controlling the reorientation of spacecraft from one attitude to another. With the advancement of technology in 1960s, satellites which were originally simple were made to have more appendages [1]. A typical spacecraft structure consists of the rigid body and flexible appendages which are large flexible solar panels, parabolic antennas built from light materials in order to reduce their weight.

The attitude control is problematic because these appendages induce structural vibration under the excitation of external forces. These structures offered new challenges in controlling flexible structures and vibrations. Furthermore, satellite receives interference from phenomena such as the earth's gravitation, air flow, magnetic fields, and the solar wind [2]. This makes it necessary to control attitude in order to maintain the satellite's stability. There are disturbance torques in space that perturb the spacecraft attitude. The major ones are aerodynamic torques caused by the rapid spacecraft

motion through the tenuous upper atmosphere, gravity gradient torque due to the small difference in gravitational attraction from one end of the spacecraft to the other, magnetic torque due to the interaction between spacecraft magnetic field and earth's magnetic field and solar radiation torque due to both the electromagnetic field and the electromagnetic radiation, radiating particles outwards from the sun. Other perturbing forces are seen as in [3], [4], whereas perturbing torques are treated extensively in [5]. These forces act on the flexible appendages making them to deviate from desired position.

The PID Controller is the simplest, easiest, and most used controller in industries. This is one reason that the PID has flourished in satellite control [6]. Its widespread is attributed to simple structure and robust performance over a wide range of operation condition, [7]. PID can be tuned by various methods, some of these are described in [8]-[11]. PID controllers may be tuned in a variety of ways, including hand-tuning, Ziegler – Nichols tuning, loop shaping, analytical methods, by optimization, pole placement, or auto tuning [12], [13] conducted numerous experiments and proposed rules for determining values of K_p , K_i , and K_d . They proposed more than one rules, among them are open loop and the close loop tuning rule [13]. The tuning of PID controller is done by trial and error method which is time consuming and can lead to waste of resources and inefficiency.

In this paper, Particle Swarm optimization algorithm is employed to tune the parameters of the PID controller to obtain PID parameters, which are used for Attitude control of a flexible Satellite with uncouple axes.

II. MODEL OF ATTITUDE OF FLEXIBLE SATELLITE WITH UNCOUPLED AXES

The equations according to [14] were used to build the simulink model of the satellite. The equations of attitude of a flexible satellite with uncoupled axes of areas:

$$\dot{\theta}(t) = 0.0064\tau \quad (1)$$

$$\ddot{\alpha}(t) = k_1\tau - \omega^2\alpha(t) \quad (2)$$

$$y(t) = \theta(t) + k_2\alpha(t) \quad (3)$$

where θ is the rotation due to the center body motion, α is the rotation due to flexible motion, ω is the un-damped natural frequency of the appendages, $y(t)$ is the total attitude of the

M. C. Orazulume is with the Department of Electrical and Electronics Engineering, University of Maiduguri, Maiduguri, Nigeria. (e-mail: chikomarthaa@yahoo.com).

J. D. Jiya is with the Department of Electrical and Electronics Engineering, Abubakar Tafawa Balewa University, Bauchi, Nigeria. (corresponding author, phone: +2347032153 315, e-mail: jibjiya27@gmail.com.).

satellite which a function flexible and rigid motion. τ is the control torque, K_1 amplifies the effect of torque on the flexure, K_2 indicates the contribution of the flexural vibration to the total attitude deviation.

III. PID CONTROLLER BASED PSO ATTITUDE CONTROL OF FLEXIBLE SATELLITE

The structure of the PID based PSO Attitude Control of Flexible Satellite System is shown in Fig. 1.

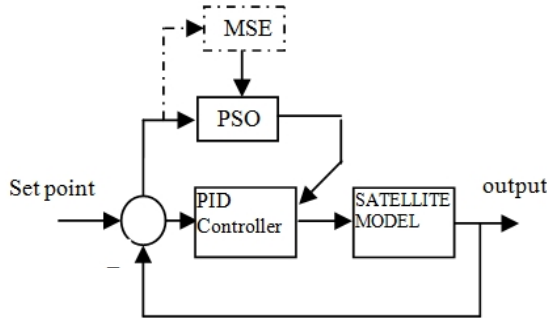

Fig. 1 Structure of PID based PSO Control System

A. PID Controller

The weighted sum of these three actions is used to adjust the process via a controller.

$$U = K_p e + K_i \int e dt + K_D \frac{de}{dt} \quad (4)$$

where U is the control signal, K_p is the proportional gain, K_i is the integral gain, K_D is the derivative gain.

B. Particle Swarm Optimization

Particle swarm optimization (PSO) is a population based stochastic optimization technique developed by Dr. Eberhart and Dr. Kennedy in 1995, inspired by social behavior of bird flocking or fish schooling [15]. It resembles the scenario of bird flocking or fish schooling whereby assuming there is a food in the field or search space. Not all the birds know where the food is but they know how far the food is by following the bird nearest to the food. Each bird flies through the space keeping track of its best position.

Let i^{th} particle represented in the d -dimensional space as:

$$x_i = (x_{i,1} \ x_{i,2} \ \dots \ x_{i,d}) \quad (5)$$

The best previous position of the i^{th} particle is recorded and represented as:

$$P_{best_i} = (P_{best_{i,1}} \ P_{best_{i,2}} \ \dots \ P_{best_{i,d}}) \quad (6)$$

The velocity for the i^{th} particle represented as:

$$v_i = (v_{i,1} \ v_{i,2} \ \dots \ v_{i,d}) \quad (7)$$

The position of the particle is changed by adding a velocity, $V_i(t)$, to the current position, i.e.

$$x_{i,m}^{t+1} = x_{i,m}^t + v_{i,m}^{t+1} \quad (8)$$

$$v_{i,m}^{t+1} = w \cdot v_{i,m}^t + c_1 \cdot \text{rand}() \cdot (p_{best_{i,m}} - x_{i,m}^t) + c_2 \cdot \text{rand}() \cdot (g_{best_m} - x_{i,m}^t) \quad (9)$$

$$i = 1 \ 2 \ \dots \ n$$

$$m = 1 \ 2 \ \dots \ d$$

where n is the number of the particle in the group, d is the dimension, t is the pointer of the iterations (generations), w is the inertia weight factor [16], c_1 and c_2 are positive acceleration constants used to scale the contribution of the cognitive and social components respectively, $\text{rand}()$ are random values in the range $[0, 1]$, $v_{i,m}^t$ is velocity of particle i at iteration t , p_{best} is the best previous position of the i^{th} particle, g_{best} is the best particle among all the particles in the population. $x_{i,d}^t$ is the current position of the particle i at iterations.

C. Performance Indices

The objective function is the measure of the performance of the controlled system. There are different types of performance indices which are Integral of Square Error (ISE), Mean Square Error (MSE), Integral of Time times Absolute value of Error (ITAE), Integral of Absolute value of Error (IAE) and Integral Time times Square of Errors (ITSE). In this study, the MSE given in (10) was employed.

$$J = \frac{1}{n} \sum_{t=1}^n (e(t))^2 \quad (10)$$

Mean Square Error reflects all variation and deviation from the target value.

IV. SIMULATION RESULTS AND DISCUSSION

A. Specification

The controller was required to regulate the attitude of the satellite from an initial angle of 60° (1.072 rad) to 0° . $\alpha(0) = 0$ was used throughout.

For nominal case, the specifications according to [14] were used where $k_1 = 0.076$, $k_2 = 0.076$ and $\omega^2 = 4.509$ (rad/s²) and the maximum available torque $\tau_{max} = 10\text{Nm}$.

Simulations were also carried out for some process mismatch situations which might arise in modern satellite. These situations are as:

1. Reduced natural frequency $\omega^2 = 1.7$ (rad/s)²
2. $k_1 = 0.76$ and other parameters as in nominal case
3. $\omega^2 = 1.7$ (rad/s)² and $k_2 = 0.114$
4. $\omega^2 = 1.7$ (rad/s²), $k_1 = 0.114$ and $k_2 = 0.2$

B. Parameters of PSO Algorithm

The parameter values of PSO Algorithm used in the simulation are shown in Table I.

C. PID Tuning Using PSO Algorithm

The parameters of PID controller are obtained from the simulation of the performance index given in (10) using PSO algorithm. The optimal parameters of PID controller obtained are shown in Table II and the graph of performance index with number of iteration is shown in Fig. 2.

TABLE I
 PSO ALGORITHM INITIALIZATION PARAMETERS

Swarm parameter	Value
Number of iterations	100
Number of particles	100
Inertia weight	0.729
Cognitive acceleration C_1	1.55
Social acceleration C_2	1.55

TABLE II
 VALUES OF P, I AND D PARAMETERS FROM MSE PERFORMANCE INDEX

PID Parameter	Nominal case	MSE
P	41.0468	-41.2234
I	3.7302	-3.9324
D	112.464	-112.4628

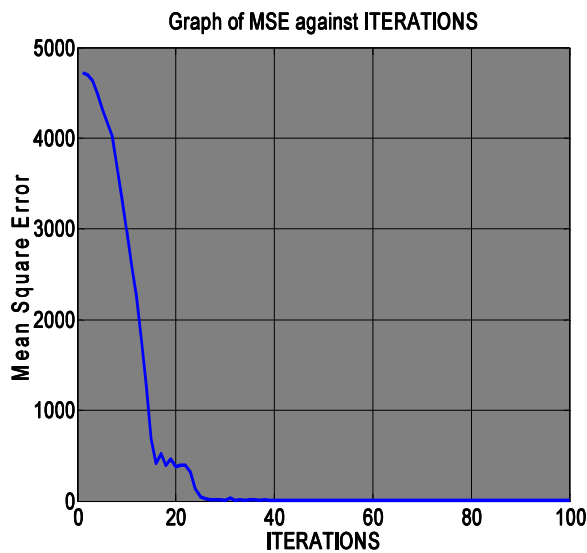
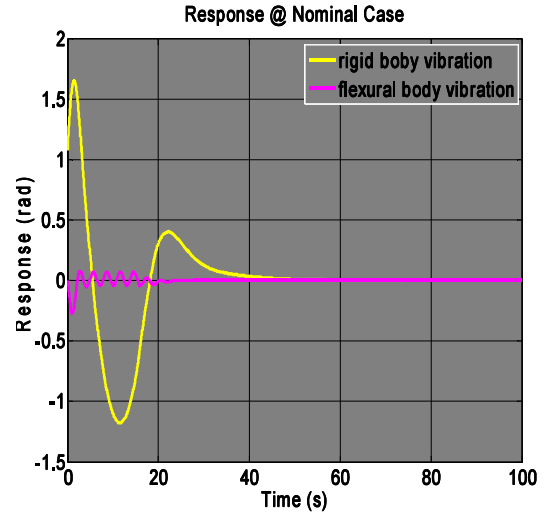

Fig. 2 MSE against iteration

The PID controller was tuned with MSE performance index and the values of its parameters were: $P = -41.2234$, $I = 3.9324$ and $D = -112.4628$.

D. Simulation Results

Considering nominal case, where $k_1 = 0.076$, $k_2 = 0.076$ and $\omega^2 = 4.509 \text{ (rad/s}^2\text{)}$ and the maximum available torque $\tau_{\max} = 10\text{Nm}$. The graphs obtained are shown in Figs. 3 (a) and (b).



(a)

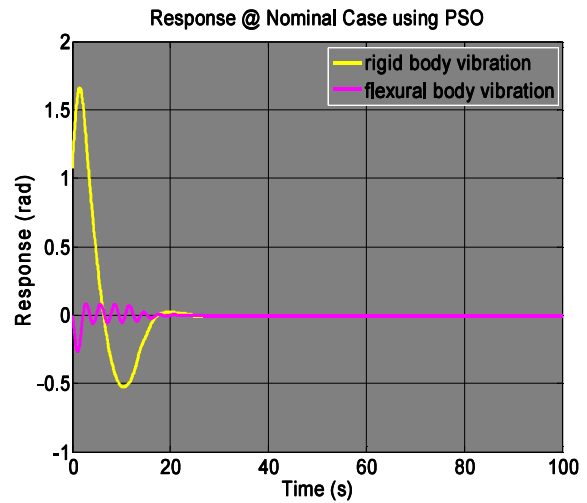

(b)

Fig. 3 (a) Response of the Flexible and Rigid Body @ Nominal Case using PID, (b) Response of the Flexible and Rigid Body @ Nominal Case using PID based PSO

Next, consider reduced natural frequency, simulations were also carried out for some process mismatch situations which might arise in modern satellite. The situations are as follows:

1. Reduced natural frequency $\omega^2=1.7 \text{ (rad/s}^2\text{)}$, the graphs obtained are shown in Figs. 4 (a) and (b).
2. At $K_1=0.76$ and other parameters as in the nominal case, the results of the simulations are shown in Figs. 5 (a) and (b).
3. At $\omega^2=1.7 \text{ (rad/s}^2\text{)}$ and $k_2=0.114$ with other parameters unchanged, the results of the simulations obtained are shown in Figs. 6 (a) and (b).
4. At $\omega^2=1.7 \text{ (rad/s}^2\text{)}$, $K_1=0.114$ and $k_2=0.2$, the results of the simulations obtained are shown in Figs. 7 (a) and (b).

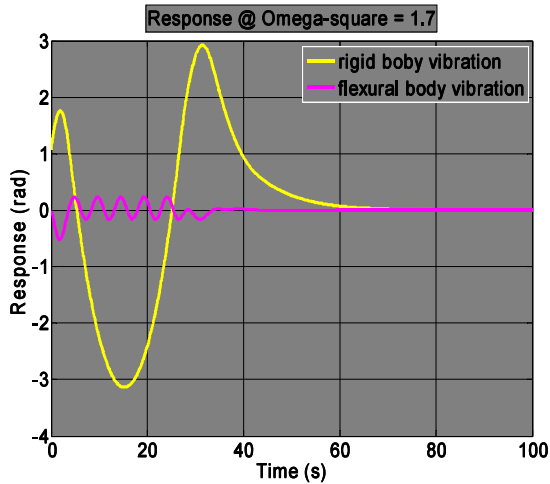

(a)

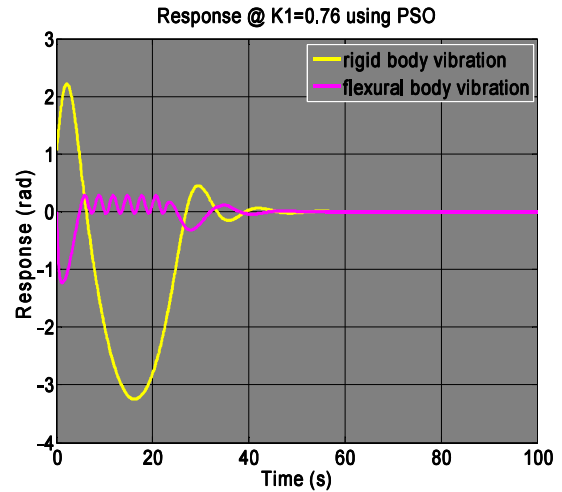
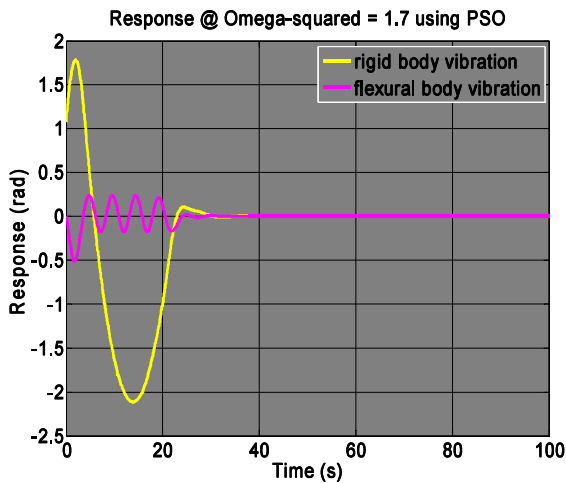
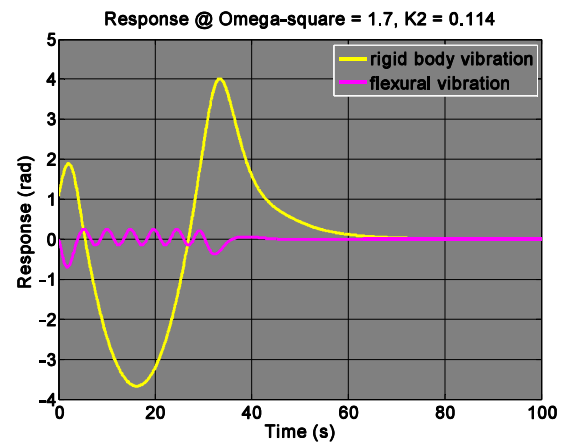

Fig. 5 (a) Response of the Flexible and Rigid Body @ $K_1 = 0.76$ using PID, (b) Response of the Flexible and Rigid Body @ $K_1 = 0.76$ using PID based PSO



(b)



(a)

Fig. 4 (a) Response of the Flexible and Rigid Body @ $\omega^2=1.7$ using PID, (b) Response of the Flexible and Rigid Body @ $\omega^2=1.7$ using PID based PSO

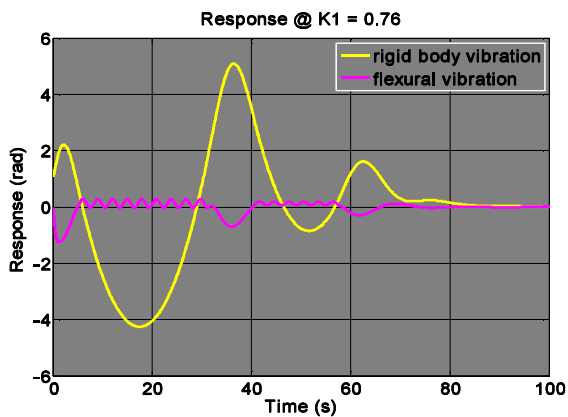

(a)

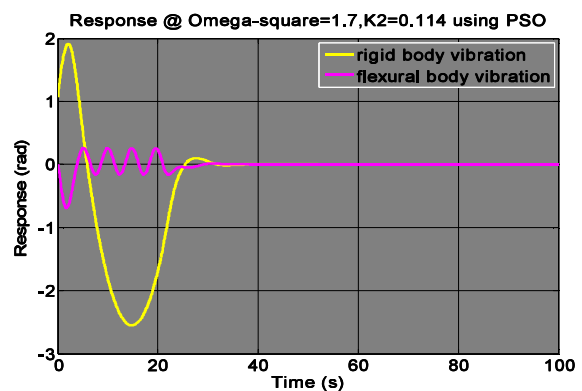

(b)

Fig. 6 (a) Response of the Flexible and Rigid Body @ $\omega^2=1.7$ (rad/s^2) and $k_2=0.114$ using PID (b) Response of the Flexible and Rigid Body @ $\omega^2=1.7$ (rad/s^2) and $k_2=0.114$ using PID based PSO

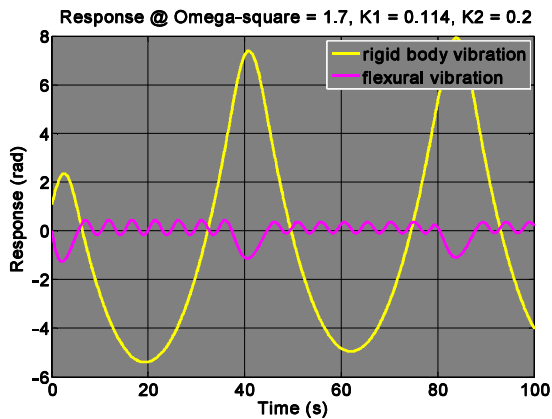

(a)

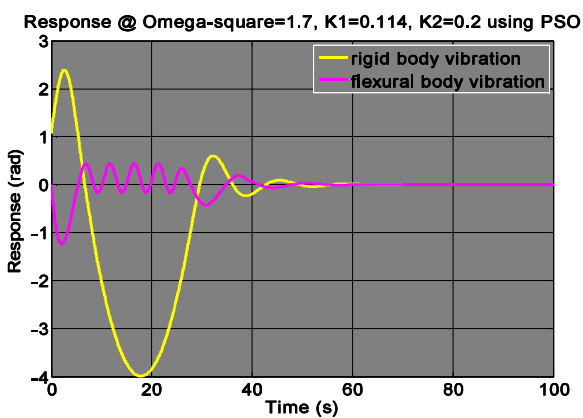

Fig. 7 (a) Response of the Flexible and Rigid Body @ $\omega^2=1.7$ (rad/s^2), $K_1=0.114$ and $k_2=0.2$ using PID, (b) Response of the Flexible and Rigid Body @ $\omega^2=1.7$ (rad/s^2), $K_1=0.114$ and $k_2=0.2$ using PID based PSO

V. DISCUSSION

A. Nominal Case

In nominal case, it can be seen that the response of the flexible and rigid bodies as shown in Fig. 3 (a), stabilized at 20s and 40s respectively using PID while in Fig. 3 (b), both responses stabilize at 20s using PID based PSO.

B. Reduced Natural Frequency

It can be seen that the response of the flexible and rigid bodies as shown in Fig. 4 (a) stabilized at 32s and 60s respectively using PID, while Fig. 4 (b) shows that both responses stabilized at 30s using PID based PSO. When the natural frequency is reduced that is when $\omega^2 = 1.7$ (rad/sec^2) or when the flexible attachments were made thinner or longer, there is a more mass transfer resulting in high value of the total attitude. The contribution of the flexural appendages to the total attitude was insignificant.

1. It can be seen from Figs. 5 (a) and (b) that the response of the flexible and rigid bodies stabilized at 70s and 80s using PID and both stabilized at 45s using PID based PSO respectively. At $k_1 = 0.76$ that is when the appendages

were made thinner and the satellite is required to respond faster to the attitude control command.

- It can be seen from Fig. 6 (a) that the response of the flexible and rigid bodies stabilized at 35s and 60s respectively using PID, but both stabilize at 30s using PSO as shown in Fig. 6 (b). When $\omega^2 = 1.7$ (rad/sec^2), $k_2 = 0.114$, it can be seen from Figs. 6 (a) and (b) that there is increase in the contribution of the appendages vibration to the final attitude. This is also the same as increasing the length of the appendage or reducing its thickness.
- It can be seen from Fig. 7 (a) that both the flexible and rigid bodies are in continuous vibration when PID is used but both stabilized at 50s when PID based PSO is used as shown in Fig. 7 (b). When $\omega^2 = 1.7$ (rad/sec^2), $k_1 = 0.114$, and $k_2 = 0.2$, it can be seen that the rigid body contributes significantly to the final attitude more than the flexural appendages.

VI. CONCLUSION

When the simulation is done with PSO parameters, the total attitude of the satellite reduced drastically as the simulation time increases. When the natural frequency is reduced that is when $\omega^2 = 1.7$ (rad/sec^2) or when the flexible attachments are made smaller, there is a more mass transfer resulting in high value of the total attitude. The contribution of the flexural appendages to the total attitude was insignificant. At $k_1 = 0.76$ that is when the appendages were thinner, the satellite is required to respond faster to the attitude control command. When $\omega^2 = 1.7$ (rad/sec^2), $k_2 = 0.114$, there is increase in the contribution of the appendages vibration to the final attitude. When $\omega^2 = 1.7$ (rad/sec^2), $k_1 = 0.114$, and $k_2 = 0.2$, flexural appendages have less significant effect on the total attitude. Finally, it can be seen that although the PID controller performed well in controlling the attitude of the satellite except when $\omega^2 = 1.7$ (rad/sec^2), $k_1 = 0.114$, and $k_2 = 0.2$, tuning its parameters with PSO performed better.

REFERENCES

- K. J. Walchko, "Robust Nonlinear Attitude Control with Disturbance compensation", 2003.
- C. D Brown, "Elements of Spacecraft Design", AIAA Education Series, 2002.
- O. Montenbruck and E. Gill, "Satellite Orbits: Models, Methods and Applications", Springer-Verlag, 2000.
- D. A. Vallado, "Fundamentals of Astrodynamics and Applications", Microcosm and press and Kluwer Academic publishers, 2001.
- P. C. Hughes, "Spacecraft Attitude Dynamics", John Wiley & Sons, Inc, 1986.
- K. J. Astrom and T. Hagglund, "PID controllers. Theory design and tuning, NC: Instrument Society of America, Research Triangle Park", 1995.
- Z. L. Gaing, "A Particle Swarm Optimization Approach for Optimum Design of PID Controller in AVR System", IEEE Transaction on Energy conversion, vol. 19, no. 2, p. 284.
- Z. Shafei and A. T. Shenton, "Tuning PIDtype controllers for stable and unstable systems with time delay", Automatica, Vol. 30, p. 1609-1615, 1994.
- Z. Shafei and A. T. Shenton, A.T, "Frequency domain Design of PID Controllers for Stable and Unstable Systems with Time Delay", Automatica, vol 33, p. 2223-2232, 1997.

- [10] J. Ackerman, D. Kaesbauer, "Stable polyhedra in parameter space", *Automatica*, vol. 39, p. 937-943, 2003.
- [11] J. Ackerman and D. Kaesbauer, and R. Muench, "Robust gamma-stability analysis in a plant parameter space", *Automatica*, vol. 27, 75-85, 1991.
- [12] L. C. Smith, "Fundamentals of control theory, *Chemical Engineering*", vol. 86, no. 22, p. 11 39, 1979.
- [13] J. G. Ziegler and N. B. Nichols, "Optimum settings for Automatic Controllers", *Trans. ASME*, Vol. 64, P. 759-768, 1942.
- [14] E. E. Omizegba, M. I. Onogu and O. U. O Okereke, "Fuzzy Attitude Control of Flexible Satellite with Uncoupled Axes" *Nigerian Journal of Rresearch and Development*, Vol. 3, No. 3, 2004.
- [15] J. Kennedy and R. C. Eberhart, "Particle Swarm Optimization", *Conference Proc. IEEE International Conference on Neural Networks* (Perth, Australia), IEEE Services Center, Piscataway, NJ, pp IV:1942-1948, 1995.
- [16] Y. Shi and R. C. Eberhart, "A Modified Particle Swarm Optimizer", *Conference Proceedings, IEEE Congress on Evolutionary Computation*, p. 69-73, 1998.