

Field Experience with Sweep Frequency Response Analysis for Power Transformer Diagnosis

Ambuj Kumar, Sunil Kumar Singh, Shrikant Singh

Abstract—Sweep frequency response analysis has been turning out a powerful tool for investigation of mechanical as well as electrical integration of transformers. In this paper various aspect of practical application of SFRA has been studied. Open circuit and short circuit measurement were done on different phases of high voltage and low voltage winding. A case study was presented for the transformer of rating 31.5 MVA for various frequency ranges. A clear picture was presented for sub- frequency ranges for HV as well as LV winding. The main motive of work is to investigate high voltage short circuit response. The theoretical concept about SFRA responses is validated with expert system software results.

Keywords—Frequency deviation, OCT & SCT, SFRA, Transformer winding.

I. INTRODUCTION

POWER transforms are crucial equipment in the power sector to ensure the reliable power transformation. Though power transformer is most costly equipment in power system network, we should provide a rigorous periodic monitoring and diagnostic programs to secure the transformer from failure risk throughout its life. Many types of failure occur within the transformer in which mechanical failure is considered to be more dangerous as it leads to complete damage of winding and then we have no other choice rather than to replace the faulty one with new unit. Transportation and many in-service events such as short circuit faults and lightning may results into severe electromagnetic force leads to mechanical damage of transformer. The electromagnetic forces are mainly of two types axial and radial forces and hence deformation also may belong to axial deformation or radial deformation [2]-[4]. In the last few year sweep frequency response analysis emerge as a meaningful tool in investigation of transformer mechanical integrity. SFRA, a low voltage Nonintrusive test measure the transfer functions of individual Winding and thus indicates the distortion or any type of movement within the transformer winding and core. SFRA application to transformer fall into two categories:

- Factory application:(as a quality program)
- Field application:(as a condition monitoring aspect)

Ambuj Kumar is with the Electrical Engineering Department, National Institute of Technology Hamirpur, India (Mob +91-9882515147; e-mail: ambujk940@gmail.com).

Sunil Kumar Singh is with the Electrical Engineering Department, National Institute of Technology Hamirpur, India (Mob +91-9882517363; e-mail: sunilsingh668@gmail.com).

Shrikant Singh is with the Electrical Engineering Department, National Institute of Technology Hamirpur, India (Mob +91-9882517425; e-mail: shrikant04ee48@gmail.com).

Factory applications of sweep frequency response analysis lead to quality assurance program. Whereas field application of SFRA lead to relocation and commissioning validation & in-services events monitoring and diagnosis program [8], [9].

Here in this paper we deal with field experience of sweep frequency response analysis. The interpretation of response obtained with SFRA is very complicate and needs much experience with the measurement techniques as well as references database as it contains lot of resonance in different frequency range. Different standard manual such as IEC (60076-18 ED.1), IEEE (C57.149-2012), CIGRE (BROCHER NO.342) and china electricity standard (DT/L911-2004) had mentioned various techniques of interpretation but no one leads to clear picture over number of aspect within the responses. Certain procedures are there in each standard for interpretation which is listed below:

- Time based comparison:(base line comparison)
- Type based comparison:(reference based comparison)
- Design based comparison:(phase to phase comparison)

When base line references are available, we compare each phase individually with base line and this gives accurate information about transformer integration. If base line references are not available, next comparison is to be done with sister unit. If references are also not available then phase to phase comparison for each unit is to be done. Phase to phase comparison is little more tedious as it involves manufacturing aspect. Different manufacturer of transformer have own SFRA factory response so transformers from different makeup body may varies in responses for specified range of frequencies for different phases hence interpretation of SFRA responses for transformer from different manufacturer may prove to be a little bit tedious and sometime leads to wrong information. Design of transformer also affect the responses as core type leads to radial deformation more than axial deformation whereas shell type leads to axial deformation more than radial one [1], [5]. To deal with design based comparison one must have a vast field experiences with different manufacturer base line references and also should have sound knowledge of design consideration.

II. FIELD MEASUREMENT ASPECTS

Practical application of sweep frequency response analysis deals with different types of measurement techniques related with respected terminal connections [6], [7]. But here we deals with only open circuit measurement and short circuit measurement over high voltage and low voltage winding.

A. Open Circuit Measurement

In open circuit measurement, the low voltage signal is applied to one end of winding and response is taken from another end while all other windings are floating. Open circuit measurement accounts for core magnetization effect as well as winding design aspect. For open circuit measurement, we should ensure about residual magnetism and short circuit current aspect parameter. Open circuit test is shown in Fig. 1.

B. Short Circuit Measurement

Short circuit measurements allow direct comparison between three phases of winding. The motive of this test is to isolate the core effect from measurement. High impedance path belongs to core will disappears. This test is very similar to leakage reactance test. In general test is performed on high voltage side with low voltage shorted (neutral not included).

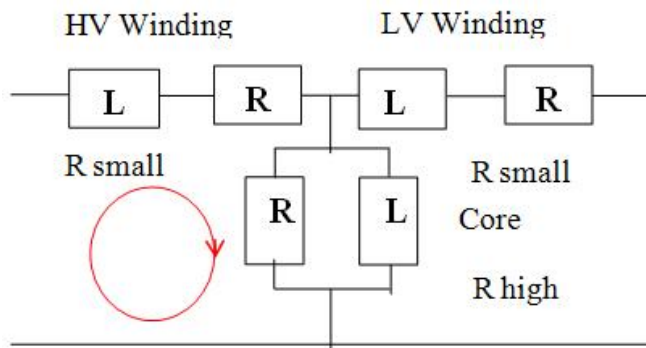

Fig. 1 Open circuit model

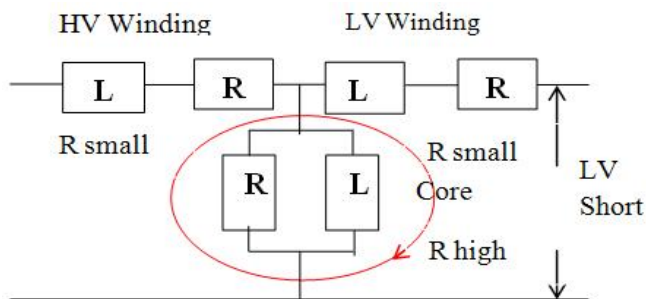

Fig. 2 Short circuit model

III. CASE STUDY (RESULT AND INTERPRETATION)

SFRA test had been done on a 3 phase transformer at Bathri, Himachal Pradesh, India. The specification of transformer is shown in Table I.

Open circuit and short circuit test is performed on high voltage and low voltage winding respectively and response is shown below. The main consideration is on short circuit measurements and phase to phase comparison techniques are

used for interpretation purpose. The different test done at power sub-station is listed in Table II.

TABLE I
TRANSFORMER HISTORY

Phase	Manufacturer	MVA rating	HV/LV rating (KV)	Sub-station
3	Kanohar	31.5	109.3/437.4	HP, INDIA

TABLE II
DIFFERENT TESTS PERFORMED AT TRANSFORMER

Name	Red	Blue	Tap Changer	Tertiary Winding	Other Winding
H3-H0	H3	H0	1	closed	open
H1-H0_2014-12-18_11-06-04	H1	H0	1	closed	open
X3-X0_2014-12-18_12-04-23	x3	x0	1	closed	open
X2-X0_2014-12-18_12-00-07	x2	x0	1	closed	open
X1-X0_2014-12-18_11-56-40	x1	x0	1	closed	open
H3-H0_2014-12-18_11-44-58	H3	H0	1	closed	closed
H2-H0_2014-12-18_11-40-51	H2	H0	1	closed	closed
H1-H0_2014-12-18_11-32-03	H1	H0	1	closed	closed

Low voltage signal is injected to one end of high voltage winding and response is taken from other end while all other windings are floating. The assessment is done with the help of DT/L 911-2004 as calculated with omicron software [1], [3].

TABLE III
EXPERT SYSTEM RESULT

RLF	RMF	RHF	E	DL/T911-2004	NCEPRI
0.7	0.39	0.1	5.49	Obvious Deformation	Slight Deformation

In high voltage response there is clear indication of bulk winding movement through mid-way frequency range. Double resonance was appeared for outer phase of high voltage winding as these outer phases see two paths for flux travel whereas center phase see only one path for flux travel. At low frequency the effect of winding inductance is negligible and the impedance is mainly due to core effect. Hence magnetization effect should be considered at the time of measurement as well as the investigation time. The resonance appeared around 2 KHz in low frequency range is parallel resonance of R, L, and C complex network. Resonance shifting in frequency range indicates winding movements and here a clear indication of resonance shift appeared in high frequency region as specified in Fig. 3. The expert system also supports the deviation aspect [9].

Now low voltage signal is applied to one end of low voltage and response is taken from other one while all other winding is floating (low voltage open circuit response).

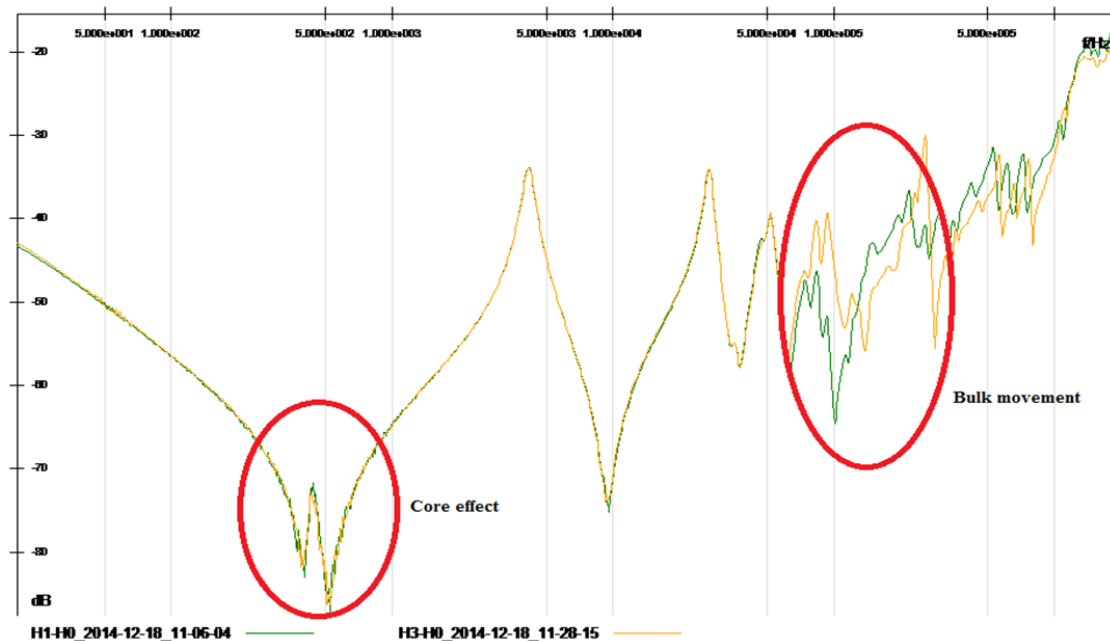

Fig. 3 High voltage open circuit response

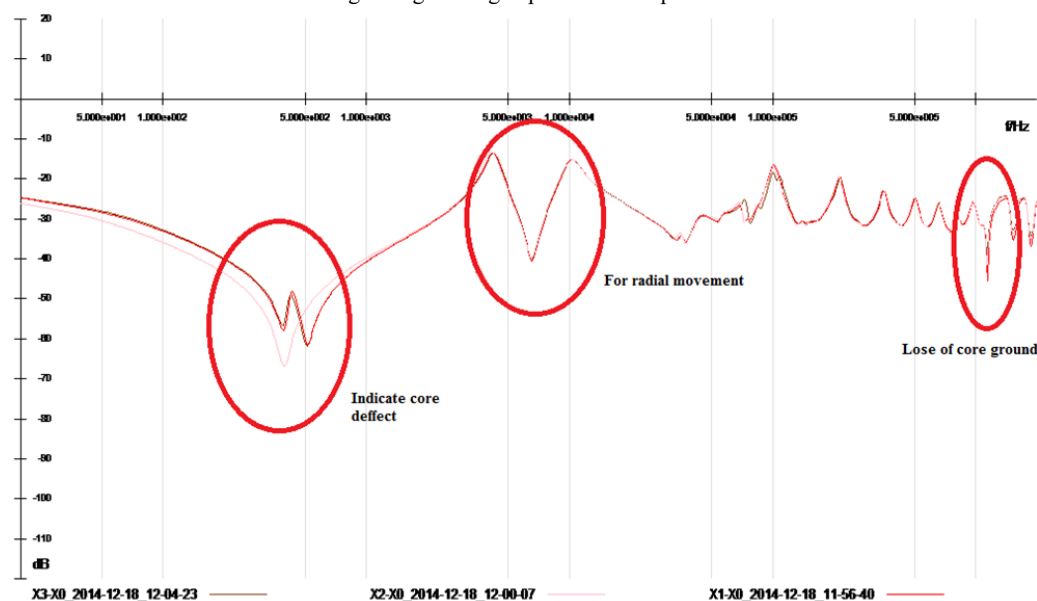

Fig. 4 Low voltage open circuit response

With the low voltage response no significant variation is seen in specified ranges. So we may consider the low voltage winding as a healthy one. But there is little bit deviation seen in lower frequency range because of design aspect and core magnetization effect. We should demagnetize the core before test with demagnetization techniques.

Now the most essential technique, short circuit measurement for phase to phase comparison was done on high voltage winding with low voltage winding shorted (without neutral). The response for different phase and their assessment is shown below. The different frequency range is shown separately for clear view of short circuit effect and also for clear indication of winding distortion and movement [6], [7].

All the phases' comparison had shown for all the measurable frequency ranges.

Fig. 6 represents that it is clearly seen that the Center phase H2 deviates from other two phases H1 and H3 of high voltage winding whereas H1 & H3 overlap each other in low frequency ranges. Here with above explanation we can't say about faulty phases whether H2 is faulty one or H1 and H3 both are faulty so further investigation is needed. Now different phase is compared with one another and assessment was also done with help of china standard to get clear picture of faulty winding. Comparison between H1-H3, H1-H2 and H2-H3 had been done and assessment is also provided with omicron software.

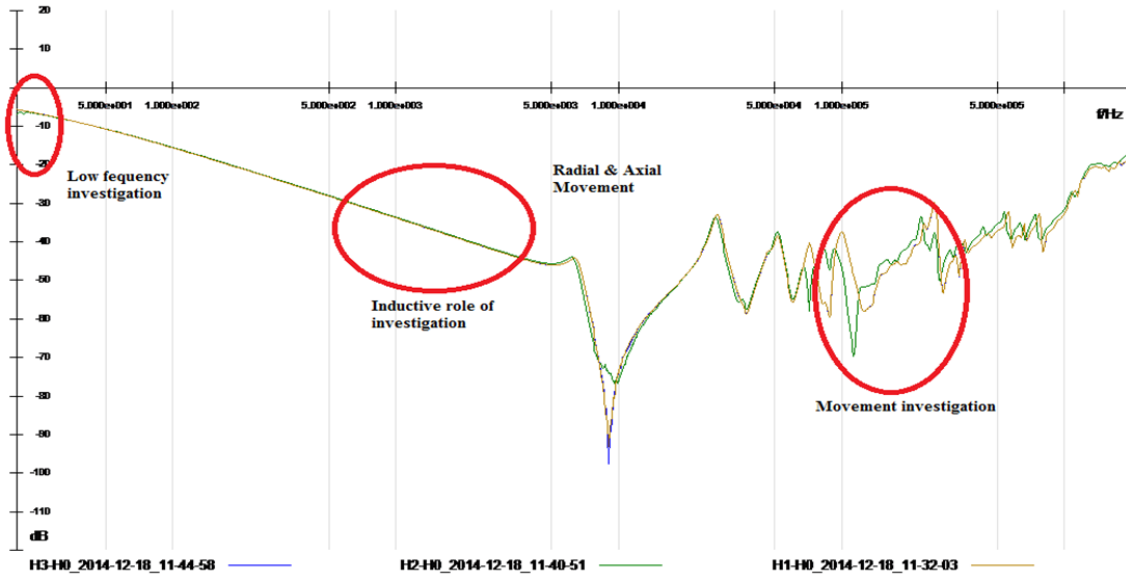

Fig. 5 Short circuit response of high voltage winding

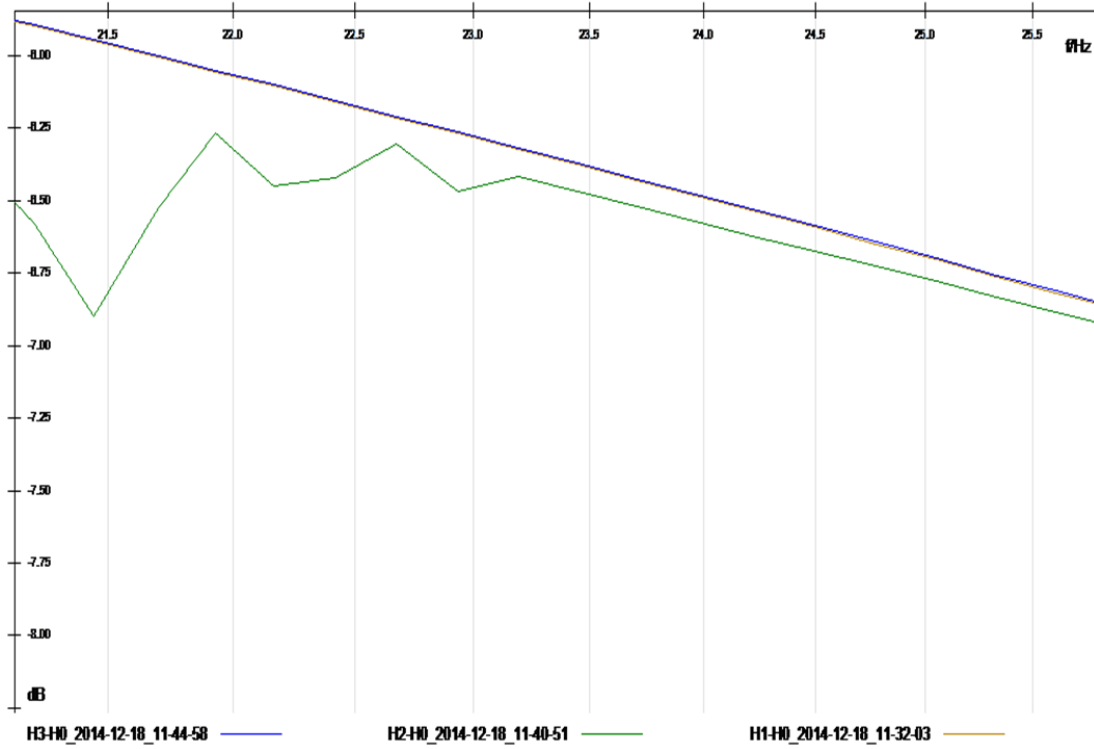

Fig. 6 Low frequency variation between different phases

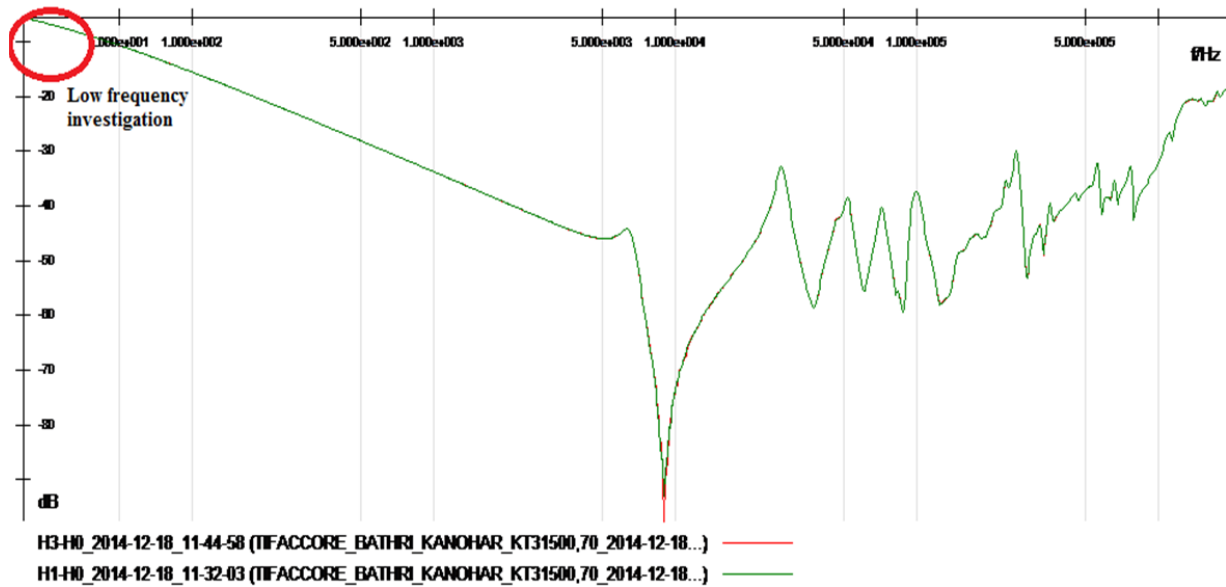

Fig. 7 Comparison of two phases for HV winding

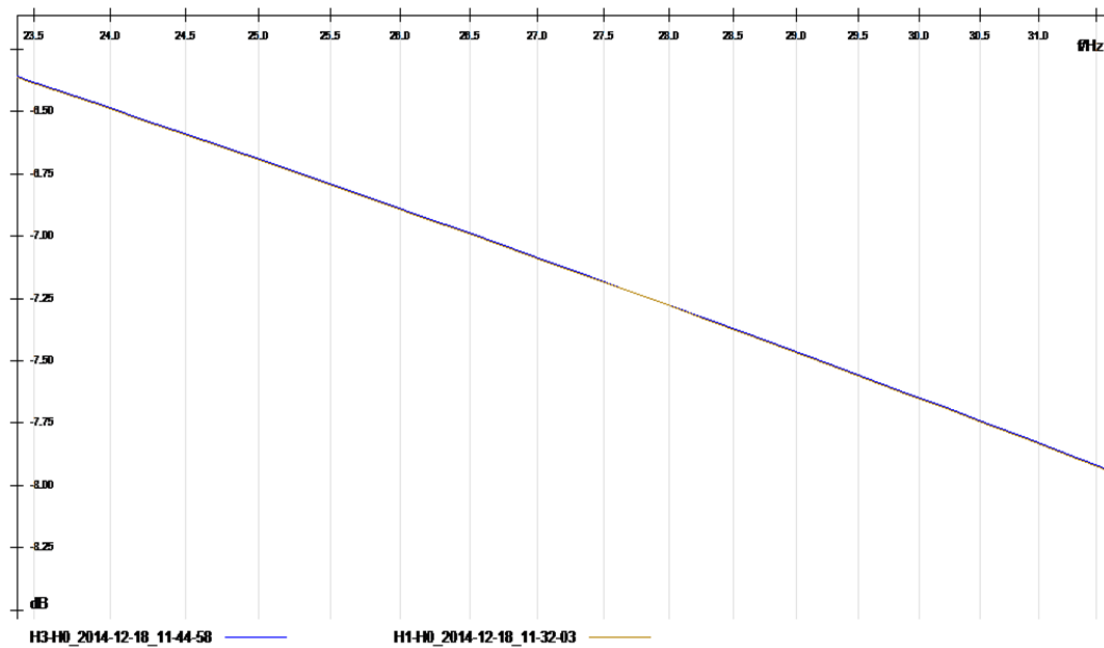

Fig. 8 Low frequency range variation for H3 & H1 phases

TABLE IV
 EXPERT SYSTEM RESULT

RLF	RMF	RHF	E	DL/T911-2004	NCEPRI
3.07	4.55	5.08	0.05	Normal Winding	Normal Winding

TABLE V
 EXPERT SYSTEM RESULT

RLF	RMF	RHF	E	DL/T911-2004	NCEPRI
0.64	0.51	0.32	5.07	Obvious Deformation	Slight Deformation

Fig. 8 represents that there is no any variation seen for phases H3 and H1 in low frequency range up to 30 Hz and expert system result also support the above explanation. With the theoretical approach interpretation had shown for type based comparison.

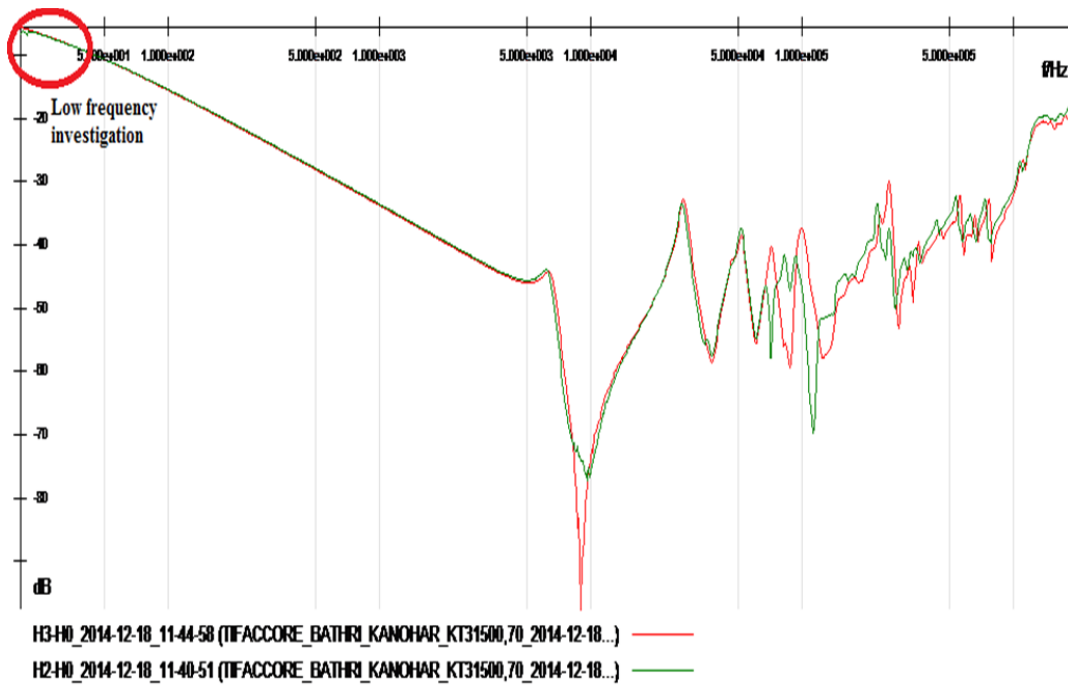

Fig. 9 Comparisons of H3 and H2 of high voltage winding

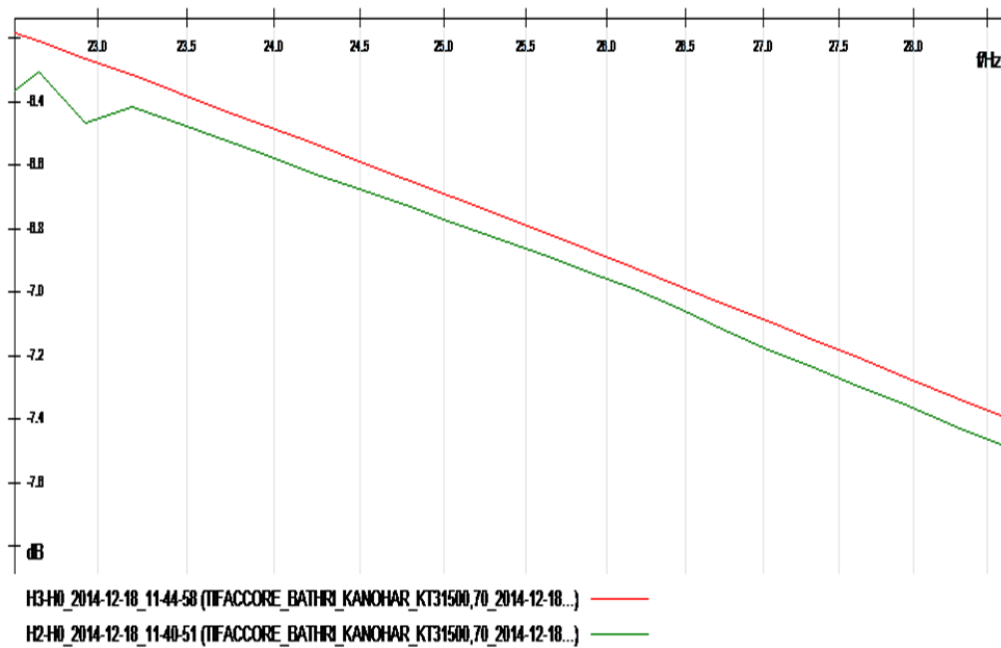

Fig. 10 Low frequency variation for H3 & H2 phase

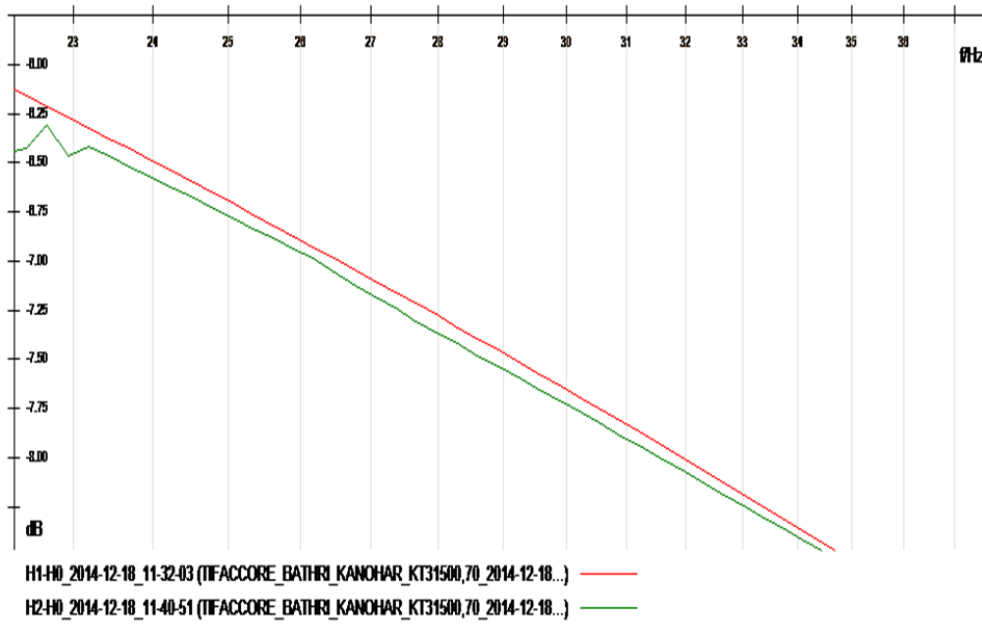

Fig. 11 Low frequency variation for H1 & H2 phases

With the comparison of three phase (H1, H2&H3) of high voltage winding shown that the phases H1 and H2 is healthy one while Center phase H2 has some distortion. The expert system results also supported the above conclusion about faulty phase. Now this result should be verified further from DC resistance test & excitation test. Now the next investigation is for inductive roll off region of high voltage

winding under short circuit measurements. The range of frequency for inductive roll off region is around 500 Hz to 2 KHz. The inductive roll off region investigation gives clearer picture about movement. With vast experience of database result taken from large number of transformer, it is concluded that the deviation should be less than 0.1 or 0.2 dB from past study.

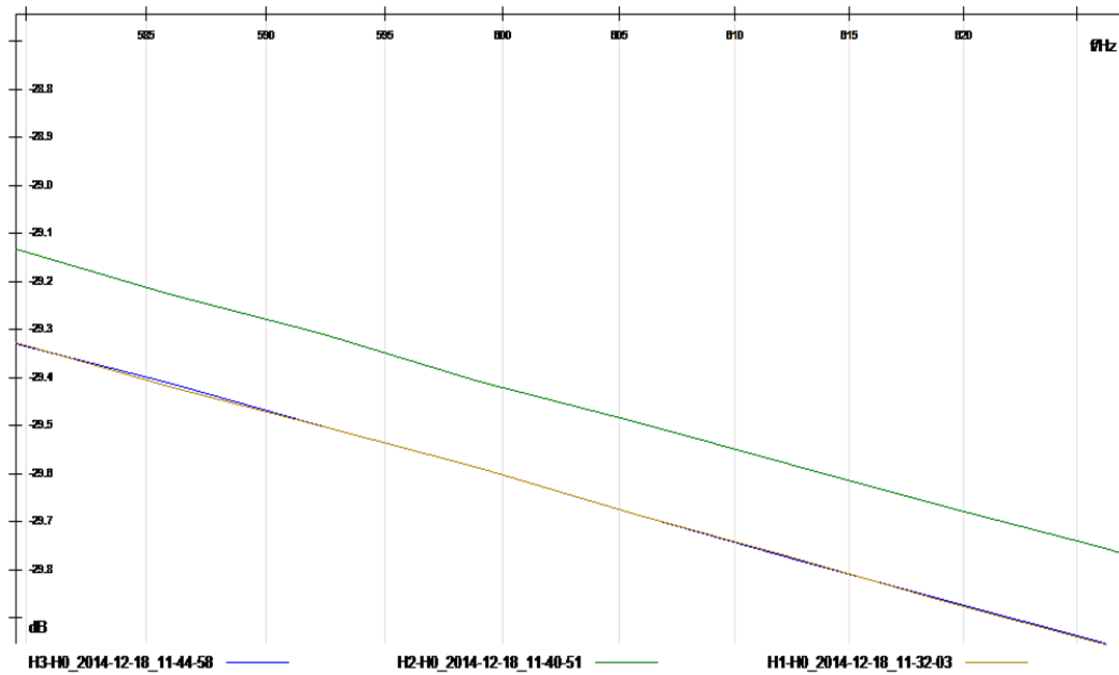

Fig. 12 Inductive roll off region for HV short circuit measurement

In Fig. 12, there is a significant variation for centre phase H2 of high voltage winding under short circuit measurement. The variation for centre phase is more than 0.2 db which indicates distortion and little movement in centre phase H2 of high voltage winding.

IV. CONCLUSION

In this paper, the theoretical and practical field experience with sweep frequency response analysis for diagnosis of transformer is presented. Open circuit and short circuits measurements with SFRA had been done on both high voltage and low voltage winding. More emphasis was given on low and inductive roll off frequency range investigations on high voltage winding under short circuit measurements. The above study clearly indicates about distortion and bulk winding movement in centre phase H2 of high voltage winding.

The practical work had been validated with the china electricity standard DL/T 911-2004 with the help of omicron software for SFRA. The result obtained from expert system support the investigation done for different frequency ranges of high voltage and low voltage winding.

ACKNOWLEDGMENT

The authors are grateful to technical member of technology information forecasting assessment council (TIFAC-CORE), NIT HAMIRPUR for frequent transformer diagnosis instruments using facility and provide data base for experimental studies.

REFERENCES

- [1] Omicron FRAnalyzer User Manual, "Sweep frequency response analyzer for power transformer winding diagnosis", Omicron electronics.2009.
- [2] Nadim Mohamed. Ee Publishers. Electromagnetic forces in transformers under short circuit conditions. Retrieved date March, 20, 2013, From http://eepublishers.co.za/images/upload/Energize_2011_07_TT_02_Electromagnetic.pdf.
- [3] The Electric Power Industry Standard of People's Republic of China, "Frequency Response Analysis on Winding Deformation of Power Transformers", China, 2005.
- [4] J.R. Secue and E. Mombello, "Sweep frequency response Analysis (SFRA) for the assessment of winding displacements and deformation in power transformers", Electric Power Research 78, 2008.
- [5] CIGRE 2009, Kreatege Kruger, ViljeenDierks, "FRA sensitivity for fault detection", 2008.
- [6] IEEE PC 57.149 Guide for the Application and Interpretation of Frequency Response Analysis for Oil Immersed Transformer; March 2013.
- [7] CIGRE WG A2.26 (342), "Mechanical condition assessment of transformer windings using Frequency Response Analysis", 2008.
- [8] WG report on "Transportation issues Guidel, IEEE (PC57.150) technical committee." "Transformer Diagnostic Testing by Frequency Response Analysis"
- [9] Dick, E. P. and Erven, C. C, IEEE Trans PAS-97, No. 6, pp 2144-2153, 1978.



Ambuj Kumar graduated in Electrical & Electronics Engineering. He is currently pursuing Master degree in condition monitoring control and Protection of electrical apparatus from NIT Hamirpur, India. His current research area is transformer engineering and practices.



Sunil Kumar Singh graduated in Electrical & Electronics Engineering from Hindustan College of science & technology, Uttar Pradesh, India in 2012. His current research interest includes condition assessment and diagnosis of insulation in power transformer. He is currently pursuing M.Tech in condition Monitoring Control and Protection of Electrical Apparatus from NIT Hamirpur, India.



Shrikant Singh graduated in Electrical Engineering from MJP Rohilkhand University Bareilly, UP, India in 2008. He is presently pursuing M.tech degree in NIT Hamirpur in Condition Monitoring Control & Protection of Electrical Apparatus. His area of interest is Residual Life Assessment of Power Transformer.