

Electrostatic and Dielectric Measurements for Hair Building Fibers from DC to Microwave Frequencies

K. Y. You, Y. L. Then

Abstract—In recent years, the hair building fiber has become popular, in other words, it is an effective method which helps people who suffer hair loss or sparse hair since the hair building fiber is capable to create a natural look of simulated hair rapidly. In the markets, there are a lot of hair fiber brands that have been designed to formulate an intense bond with hair strands and make the hair appear more voluminous instantly. However, those products have their own set of properties. Thus, in this report, some measurement techniques are proposed to identify those products. Up to five different brands of hair fiber are tested. The electrostatic and dielectric properties of the hair fibers are macroscopically tested using design DC and high frequency microwave techniques. Besides, the hair fibers are microscopically analysis by magnifying the structures of the fiber using scanning electron microscope (SEM). From the SEM photos, the comparison of the uniformly shaped and broken rate of the hair fibers in the different bulk samples can be observed respectively.

Keywords—Hair fiber, electrostatic, dielectric properties, broken rate, microwave techniques.

I. INTRODUCTION

HAIR loss has become a common issue for the public nowadays, which is influenced by age, disease, and a wide variety of other factors. Recently, the interest in hair building fiber has increased because it is able to conceal hair loss within 30 seconds by spreading the fiber on the hair. The fiber will be tied to every existing individual strand of hair based on the electrostatic principles which can result more voluminous hair [1], [8]. In the markets, there are a lot of hair fiber brands that have been designed to formulate an intense bond with hair strands. However, those products have their own set of properties. Thus, in this work, some measurement techniques are proposed to identify those hair fibers. Up to five different brands of hair fiber are tested, namely BioTHIK, SMH, Nanogen, Toppik and XFussion. The hair fibers are microscopically analysis by magnifying the structures of the fiber using scanning electron microscope (SEM). From the SEM photos, the comparison of the uniformly shaped and broken rate of the hair fibers in the different bulk samples can be observed respectively. Besides, the electrostatic and dielectric properties of the hair fibers are macroscopically tested using design DC and high frequency microwave techniques. In this work, the dielectric properties of the hair fiber has been measured in the microwave frequency range, since the microwave signal often circulate around our daily

life, such as the signal generated from mobile phone and WiFi internet server. The measurement methods and results analysis will be described in Sections III, IV and V, respectively.

II. ELECTROSTATIC AND DIELECTRIC PROPERTIES OF HAIR FIBER

Basically, the performance of the hair fiber is measured based on its charge density which allow the fiber to be attached to the real human hair [1]. In fact, the total amount of charge in the fiber is often changing depends on the fiber conditions and the environmental conditions [4]. As a matter of fact, the amount of charge on the fiber can be increased by shaking the fiber in the container before the fiber is used. Friction between the fiber and the inner wall of the container will generate an additional frictional charge on the fiber.

In this study, all fiber samples are measured without performing any shaking, so that the measurement results will be more consistent and precise. The charges on the hair fiber at DC stage is determined based on the measured voltage, V (in unit Volt) and measured capacitance, C (in unit Farad) of the hair fiber. The relationship between the accumulated charge, Q , voltage, V and capacitance, C is given as:

$$Q = V \times C \quad (1)$$

The capacitance, C in (1) is the parameter to measure the ability of the hair bulk fiber to store an electrical charge. The value of the capacitance, C , which is higher indicates that more charges can be stored in the bulk fiber.

According to electrostatic theory, the capacitance, C is directly proportional to the dielectric properties of the fiber. Thus, indirectly, the performance of the fiber can also be referred to the dielectric properties of the bulk fiber. The dielectric properties are quantitatively represented by the value of relative permittivity, ϵ_r , which is written as:

$$\epsilon_r = \epsilon_r' - j\epsilon_r'' \quad (2)$$

where the real part, ϵ_r' is the dielectric constant and imaginary part, ϵ_r'' is the dielectric loss factor. The dielectric constant, ϵ_r' influences the electric field distribution and the phase of waves traveling through the fiber. In contrast, the loss factor, ϵ_r'' influences the energy absorption or attenuation of the fiber. From the loss factor, ϵ_r'' , the conductivity, σ of the five types of the hair fibers can be relatively compared, since the loss factor at low frequencies, f ($f < 2$ GHz) is mainly contributed by the conductivity of the hair fiber. The relationship between the conductivity, σ (in unit S/m) and the loss factor, ϵ_r'' is given as:

K. Y. You and Y. L. Then are with the Communication Engineering Department, Faculty of Electrical Engineering, Universiti Teknologi Malaysia, 81310 UTM Skudai, Malaysia (e-mail: kyyou@fke.utm.my, andythenyl@yahoo.com).

$$\sigma = 2\pi f \epsilon_0 \epsilon_r'' \quad (\text{for } f < 2 \text{ GHz}) \quad (3)$$

where ϵ_0 ($\approx 8.854187817 \times 10^{-12}$ F/m) is the permittivity of free space. The conductivity, σ of the fiber can contribute to the perpendicular fiber binding effect. This means that every individual rod fiber can conduct opposite charge between both ends of the rod. One end of the rod fiber can bind to the human hair whilst other end will be repelled from the human hair and produce the perpendicular arrangement [1].

The magnified images ($\times 1000$) reveal that the fiber structure of BioTHIK is very similar to SMH and both fiber rods have uniform shape. On the other hand, the fiber structure of Nanogen is similar to Xfusion. In addition, the Nanogen fiber rod is quite similar to the structure of the actual human hair.

III. SCANNING ELECTRON MICROSCOPE ANALYSIS

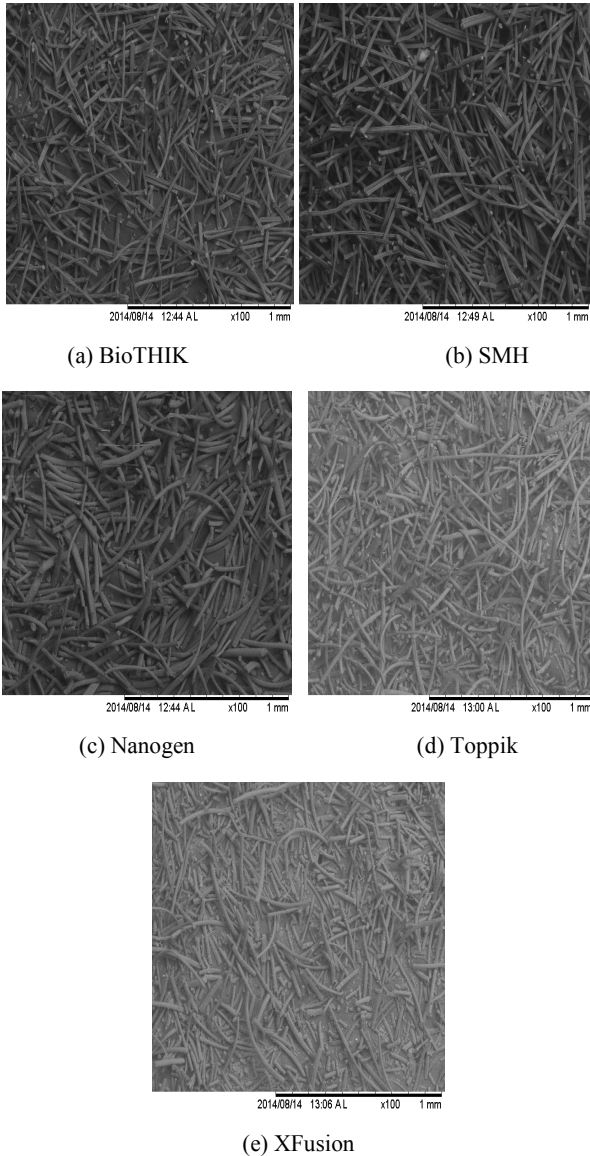
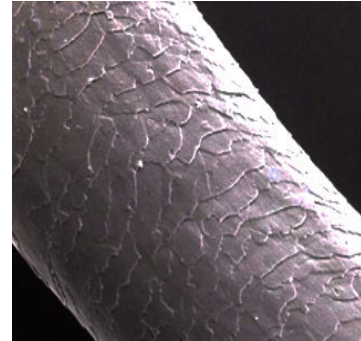

Fig. 1 SEM images of the distribution of hair fiber with 100-fold magnification

The structure of the five fibers is magnified up to $\times 100$ and $\times 1000$, respectively, using Hitachi TM 3000 Tabletop Scanning Electron Microscope (SEM) as shown in Figs. 1 and 2, respectively. Fig. 1 shows that the fiber distribution of the SMH is more compact compared to other fiber. Among the five types of fibers, XFusion shows the highest broken rates.



(a) Normal human hair structure [2]

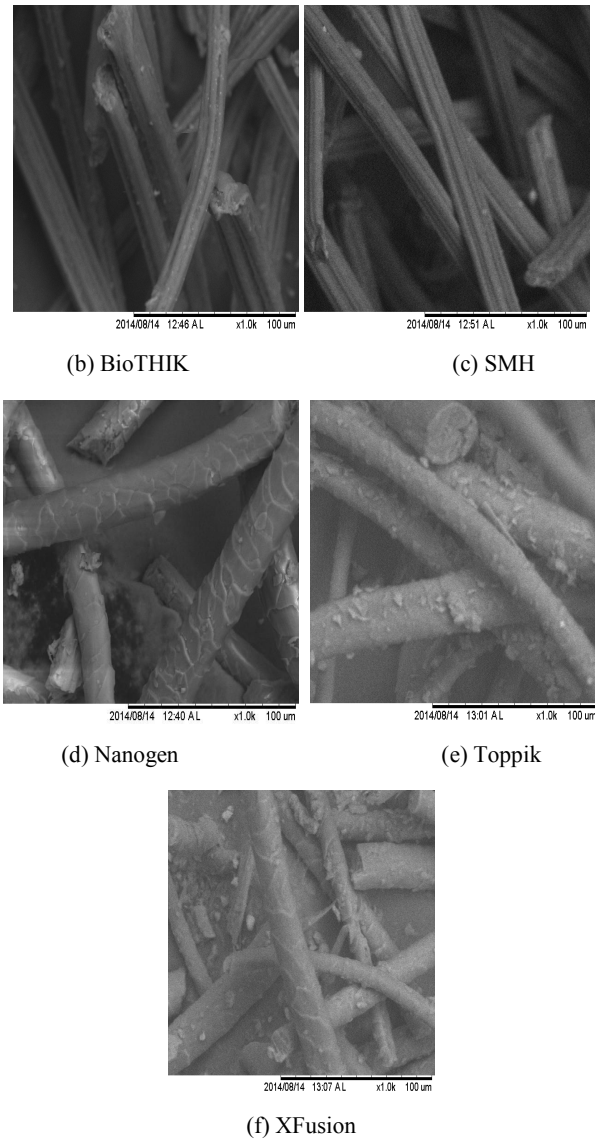

Fig. 2 Comparison between the human hair [2] and the simulated hair fiber structures

IV. DC ELECTROSTATIC MEASUREMENTS

In this work, the charge, Q on the hair fiber is measured using designed capacitance sensor as shown in Fig. 3.

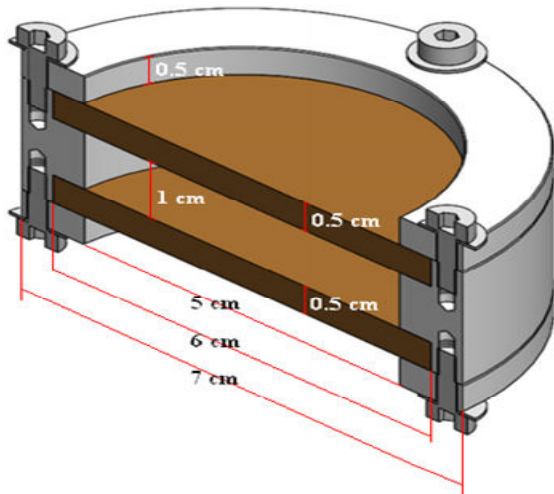

Fig. 3 Cross-sectional view of the capacitance sensor with labeled dimensions

The sensor consists of two circular metallic plates (Brass) with 3 cm of radius, two plate clampers (Nylon) and one sample holder cover (Nylon) as shown in Fig. 4. Up to 19.64 cm³ of fiber sample is required to be fully filled into the sample holder with 1 cm height (at the center of the gap between the two metallic plates). The sensor which filled with fiber sample, is connected to Fluke 289 multi-meter via test probe and test lead as shown in Fig. 5.

The DC voltage difference, V (mV) and capacitance, C (nF) between the two metallic plates with filled fiber samples are respectively measured. The measurements are recorded in 15 minutes period and the average values are recorded as listed in Table I. From the measured V and C , the accumulated charge, Q (pC) on the surface of the metallic plate can be calculated using (1). In addition, the DC relative dielectric constant, ϵ_r of the fiber can be interpreted as:

$$\epsilon_r = \frac{C_{sample}}{C_{empty}} \quad (4)$$

where the C_{empty} and C_{sample} are the empty-filled and fiber sample-filled measured capacitance, respectively. From the measurement results, the BioTHIK hair fiber shows the ability to store the charge is much higher compared to other fibers at DC stage.

TABLE I
 MEASURED V , C , Q AND ϵ_r AT DC STAGE

Brand	V (± 0.01 mV)	C (± 0.001 nF)	V (mV) (typ)	C (nF) (typ)	$Q = V \times C$ (pC)	ϵ_r
Empty	0.03-0.05	0.043 - 0.048	0.04	0.046	0.0018	1
BioTHIK	40 - 70	200 - 400	55	300	16500	6522
SMH	45 - 65	45 - 65	55	55	3025	1196
Nanogen	0.2 - 1	0.23 - 0.24	0.6	0.235	0.14	5.1
XFusion	0.1-0.3	0.148-0.173	0.2	0.16	0.032	3.5
Toppik	0.06-0.2	0.135-0.145	0.13	0.14	0.018	3.04

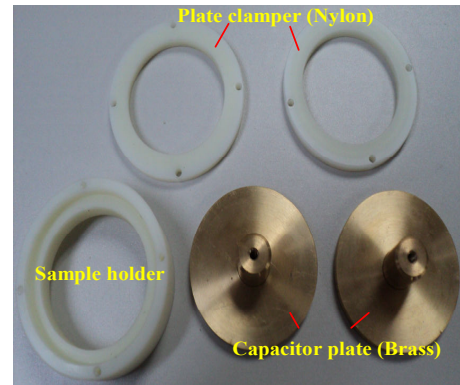

(a)

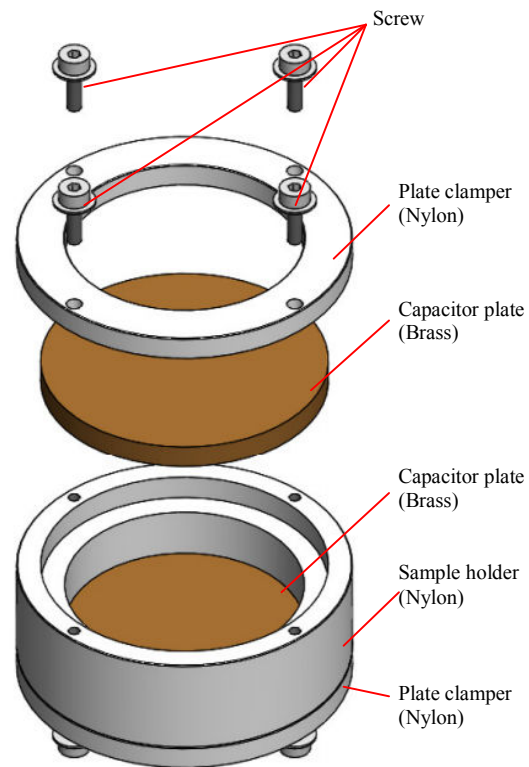

(b)

Fig. 4 (a) Sensor components (b) Sensor fabrication

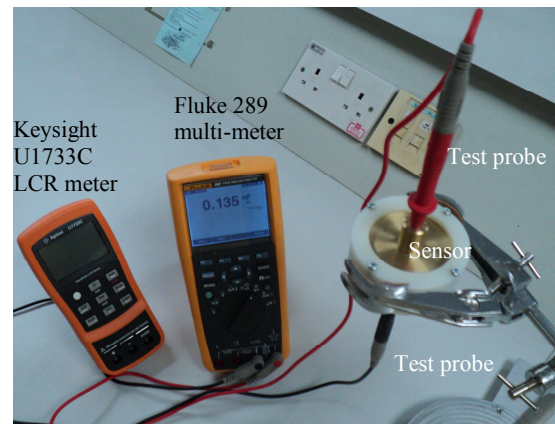

(a)

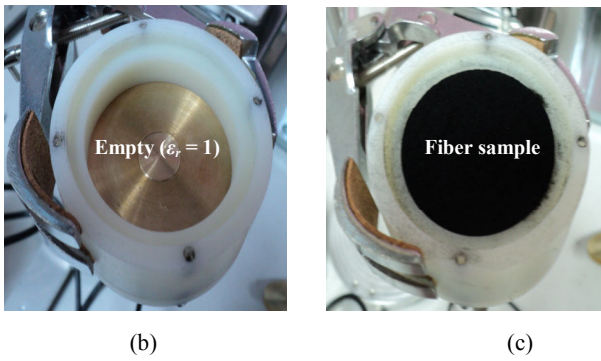

Fig. 5 (a) Sensor without sample (b) Sensor filled with fiber sample (c) Experimental set-up

V. LOSS FREQUENCY CAPACITANCE AND DIELECTRIC MEASUREMENTS

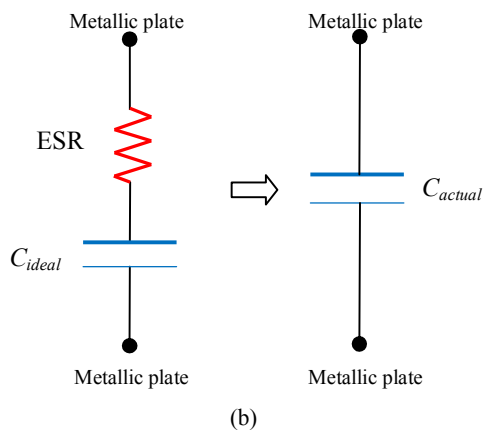
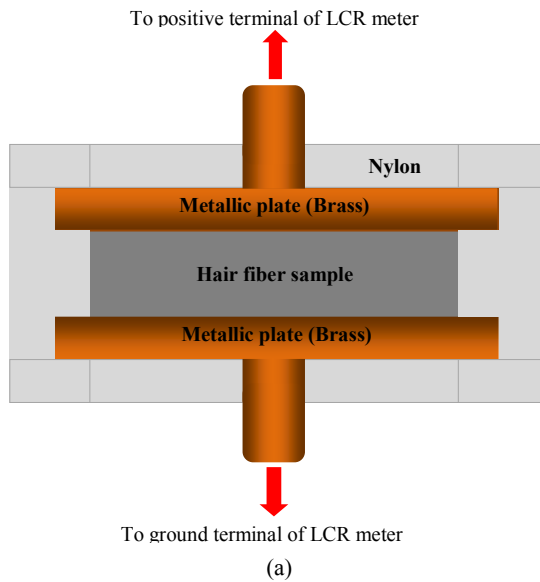

Fig. 6 (a) Cross-sectional view of capacitor sensor (b) The series combination for the measured ideal capacitance, C_{ideal} and the measured series resistance, ESR is equivalent to the actual capacitance, C_{actual} of the hair fibers

In this measurement, the Fluke 289 multi-meter which connected to the sensor, is replaced by Keysight (formerly

Agilent) U1733C handheld LCR meter. The capacitance measurement is referred to as an ideal capacitance, C_{ideal} in series with a resistance so-called equivalent series resistance (ESR) as shown in Fig. 6 (b). However, the given output measurement is in term of C_{ideal} , ESR and phase angle, θ_c as tabulated in Table II. The relationship between the C_{ideal} , ESR and θ_c are described in Fig. 6.

The series combination of ESR and C_{ideal} can be written in term of impedance, Z as [6]:

$$Z = ESR - j \frac{1}{\omega C_{ideal}} \quad (5)$$

On the other hand, the actual impedance, Z of the hair fiber sample is represented as:

$$Z = -j \frac{1}{\omega C_{actual}} \quad (6)$$

In fact, the value of C_{actual} in (6) is a complex number as:

$$C_{actual} = C'_{actual} - jC''_{actual} \quad (7)$$

The vector diagram for (5) and (6) is shown in Fig. 7.

TABLE II
 RAW MEASUREMENT DATA FOR HAIR FIBER USING U1733C LCR METER

f (Hz)	Empty			BioTHIK		
	C_{ideal} (pF)	θ_c (°)	ESR (MΩ)	C_{ideal} (pF)	θ_c (°)	ESR (MΩ)
100	22	-82.0	9.94	22000	-9.3	0.44
1k	22	-86.5	0.43	1858	-13.4	0.36
10k	20.3	-86.9	0.041	110.7	-44.4	0.15
100k	19	-89.9	0.0014	40.5	-70.4	0.014
SMH						
100	9590	-9.2	1.02	31.5	-70	18.4
1k	450	-25.2	0.75	26	-83.5	0.70
10k	65	-57	0.16	25	-86.5	0.039
100k	31.8	-72	0.016	23.5	-89.0	0.0012
Toppik						
100	27.5	-81	9.2	28	-78	12.1
1k	26	-86	0.43	26	-85.5	0.48
10k	24.6	-87	0.034	24	-87	0.035
100k	23	-89.3	0.0021	22.5	-89.4	0.00074

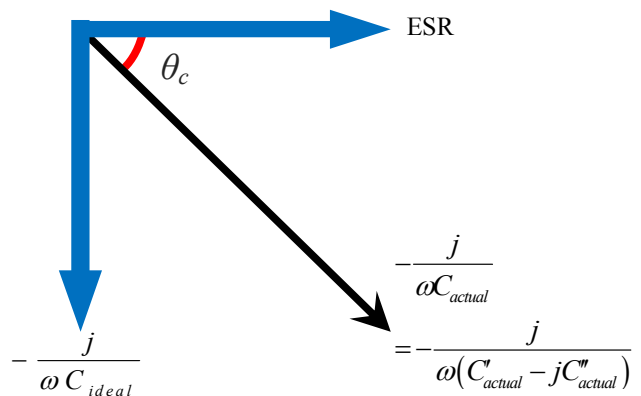

Fig. 7 Vector diagram of the impedance, Z

Applying (7) in (6), yields,

$$Z = -j \frac{1}{\omega(C'_{actual} - jC''_{actual})} \quad (8)$$

$$= \frac{C''_{actual}}{\omega\{(C'_{actual})^2 + (C''_{actual})^2\}} - \frac{jC'_{actual}}{\omega\{(C'_{actual})^2 + (C''_{actual})^2\}}$$

Through the comparison of (5) and (8), the ESR and C_{ideal} can be written as:

$$ESR = \frac{C''_{actual}}{\omega\{(C'_{actual})^2 + (C''_{actual})^2\}} \quad (9)$$

and

$$C_{ideal} = \frac{(C'_{actual})^2 + (C''_{actual})^2}{C'_{actual}} \quad (10)$$

Finally, the C'_{actual} and C''_{actual} can be obtained by solving (9) and (10) simultaneously with aid of data in Table II, as shown in Fig. 8. The C'_{actual} and C''_{actual} can be interpreted in relative permittivity, ϵ_r , as:

$$\epsilon_r = \frac{C'_{actual(sample)} - jC''_{actual(sample)}}{C'_{actual(empty)} - jC''_{actual(empty)}} \quad (11)$$

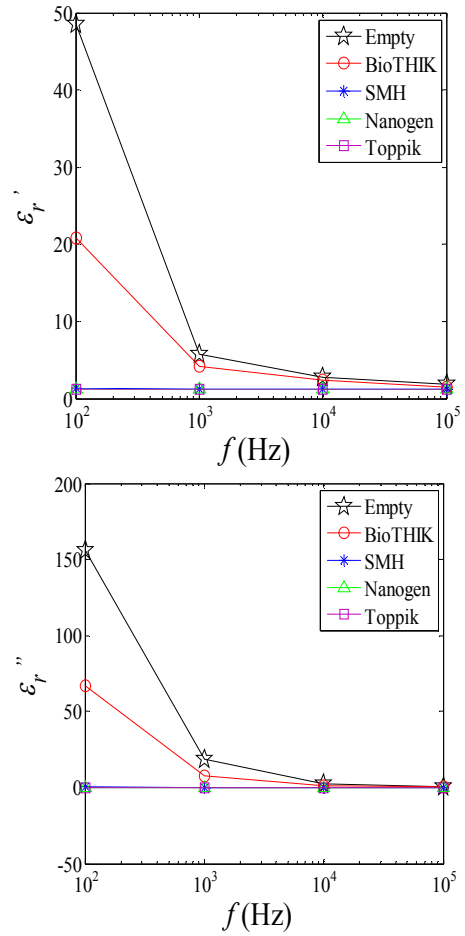
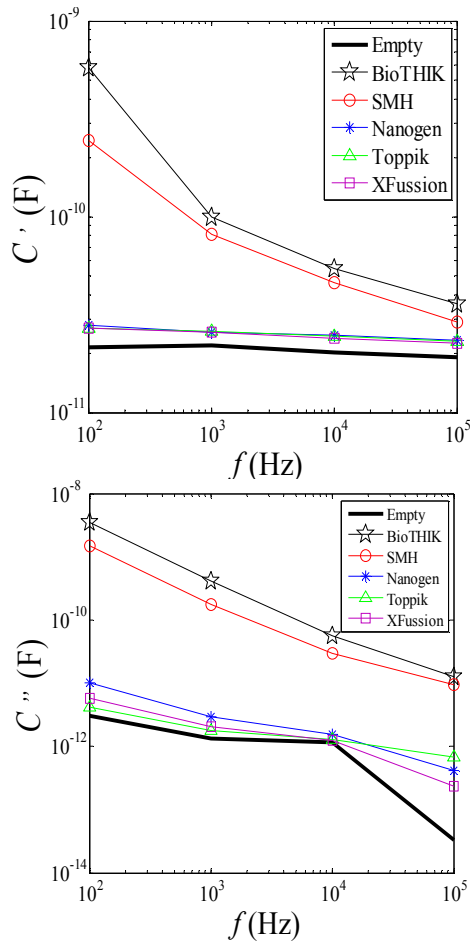

Fig. 8 Results of C' , C'' , ϵ_r' and ϵ_r'' versus operating frequency, f

VI. MICROWAVE FREQUENCY DIELECTRIC MEASUREMENTS

The relative permittivity, ϵ_r , of the hair fiber sample which filled in a 5 cm length of coaxial waveguide are obtained by measuring the reflection coefficient, S_{11} , and the transmission coefficient, S_{21} [5], [7], [9]. The structure, material and dimension of the coaxial waveguide used in the measurements is shown in Fig. 9.



(a)

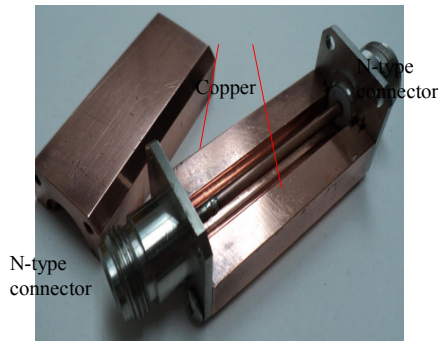

(b)

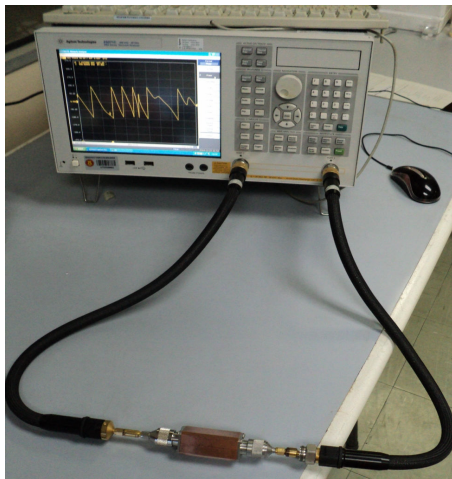

(c)

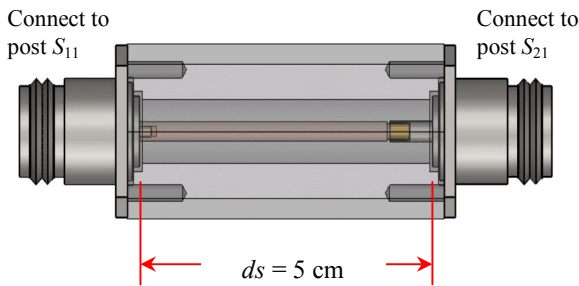

(d)

Fig. 9 (a) Components of coaxial waveguide (b) Fully-filled hair fiber sample in coaxial line (c) Experimental setup (d) Dimension of coaxial waveguide

The linear magnitude, $|S_{11}|$, $|S_{21}|$, and the phase shift, ϕ_{21} , for air and the hair fiber samples are measured with an Agilent E5071C vector network analyzer (VNA) from 0.5 GHz to 5 GHz. In Fig. 10, the $|S_{11}^{Sample}|$ and $|S_{21}^{Sample}|$ are the measured linear magnitudes of the reflection coefficient and the transmission coefficient for the sample, respectively. On the other hand, the ϕ_{21}^{Air} (in radians) and ϕ_{21}^{Sample} are the transmission phase shift of air and hair fiber sample, respectively.

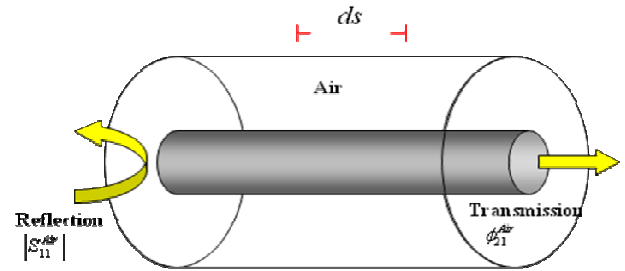

(a) Step 1: Measure the ϕ_{21}^{Air} of the air-filled coaxial line

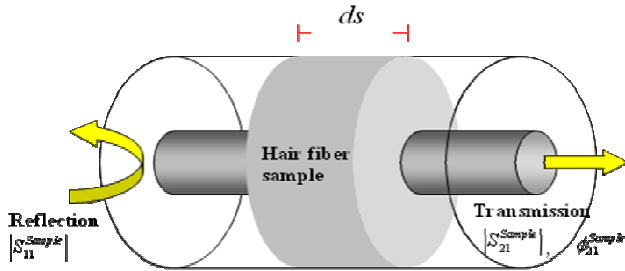

(b) Step 2: Measure the $|S_{11}^{Sample}|$, $|S_{21}^{Sample}|$ and ϕ_{21}^{Sample} of the fiber-filled coaxial line

Fig. 10 The measurement steps of hair fiber

Once the values of measured $|S_{11}^{Sample}|$, $|S_{21}^{Sample}|$, ϕ_{21}^{Air} and ϕ_{21}^{Sample} are obtained, the dielectric constant, ϵ_r' , and the loss factor, ϵ_r'' , of the fiber sample can be determined as:

$$\epsilon_r' = \frac{1}{k_o^2} \left\{ \left(\frac{\phi_{21}^{Air} - \phi_{21}^{Sample} + k_o d_s}{d_s} \right)^2 - \alpha_s^2 \right\} \quad (12)$$

$$\epsilon_r'' = \frac{2\alpha_s}{k_o^2} \left(\frac{\phi_{21}^{Air} - \phi_{21}^{Sample} + k_o d_s}{d_s} \right) \quad (13)$$

The attenuation, α_s due to the fiber sample is calculated as:

$$\alpha_s \approx -\frac{1.15129254}{d_s} \log_{10} \left(|S_{11}^{Sample}|^2 + |S_{21}^{Sample}|^2 \right) \quad (14)$$

where k_o is the propagation constant of the air-filled coaxial waveguide. The calculated ϵ_r' and ϵ_r'' for the five kinds of hair fibers are shown in Fig. 11.

VII. DIELECTRIC MEASUREMENTS USING KEYSIGHT 85070D DIELECTRIC PROBE

The Agilent 85070D dielectric probe [3] is used to measure the dielectric properties of hair fiber from 300 MHz and 5 GHz at room temperature (25 ± 1)°C, as shown in Fig. 12. The measurement results for the five types of hair fibers are shown in Fig. 13, in which the results are in good agreement with the calculated ϵ_r' and ϵ_r'' in Fig. 11.

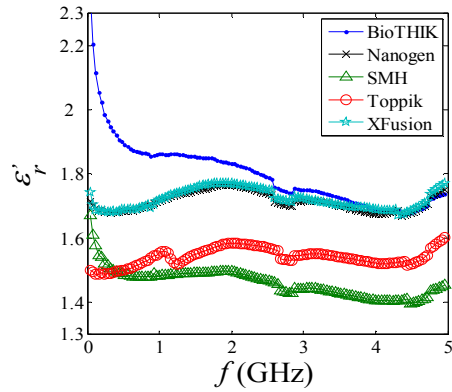

(a)

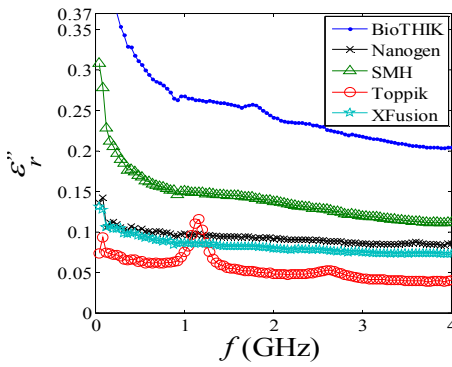

(b)

Fig. 11 The calculated (a) ϵ_r' and (b) ϵ_r'' of the five types of hair fibers



(a)



(b)

Fig. 12 (a) Keysight 85070D dielectric probe (b) Hair fiber dielectric measurement using 85070D dielectric probe

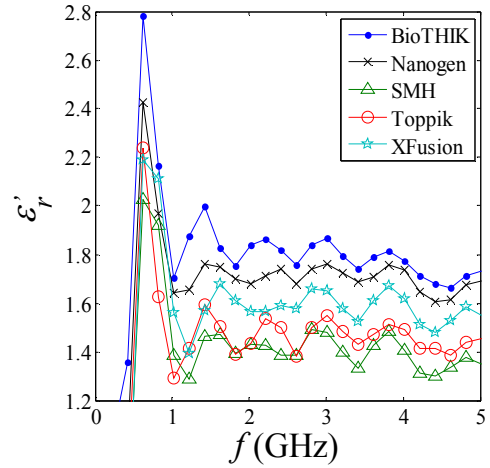

(a)

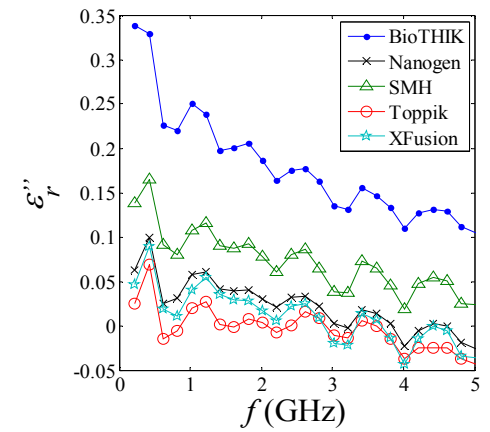

(b)

Fig. 13 The measured (a) ϵ_r' and (b) ϵ_r'' of the five types of hair fibers using 85070D dielectric probe

VIII. CONCLUSION

From the measurement results, this study provides some conclusions:

1. BioTHIK hair fiber has a higher ability to store charge compared with other fiber brands from DC to microwave frequency environment.
2. BioTHIK hair fiber has the highest conductivity, σ value which will cause the fiber bundle appears to be perpendicular to the existing hair, in which the hair will look thicker with a small volume of the fiber powder.
3. Nanogen and XFusion hair fibers have a surface structure which is very similar to the surface structure of the actual human hair.
4. Density fiber distribution in the SMH bulk fiber is the highest compared to other hair fiber brands.
5. All hair fiber shows a low fracture rate of the rod fiber in their bulk sample, except XFusion.

REFERENCES

- [1] Graham L. Hearn. *Electrostatic properties of hair building fibres*. Retrieved 2010, from <http://www.naturallycurly.com/curlreading/curl>

products/curlychemist-the-cuticle-is-the-first-line-of-defense-for-our-hair/

- [2] Tonya Mckay. *The cuticle is the first line of defense for our hair*. Retrieved May 28, 2009, from [http://www.naturallycurly.com/curl_products/curlychemist-the-cuticle-is-the-first-line-of-defense-for-our-hair/](http://www.naturallycurly.com/curlreading/curl_products/curlychemist-the-cuticle-is-the-first-line-of-defense-for-our-hair/)
- [3] Agilent Technologies, Agilent 85070D Dielectric Probe Kit: Product Overview, Agilent Technologies Inc, U.S., 2010.
- [4] A. C. Lunn, and R. E. Evans, "The electrostatic properties of human hair," *J. Soc. Cosmet. Chem.*, vol. 28, pp. 549–569, September 1976.
- [5] A. M. Nicolson, and G. F. Ross, "Measurement of the intrinsic properties of materials by time-domain technique," *IEEE Trans. Instrum. Meas.*, vol. 19, no. 4, pp. 377–382, November 1970.
- [6] D. Stepins, G. Asmanis, and A. Asmanis, "Measuring capacitor parameters using vector network analyzers," *Electronics*, vol. 18, no. 1, pp. 29–38, June 2014.
- [7] C. J. Zhao, Q. X. Jiang, and S. H. Jing, "Calibration-independent and position-insensitive transmission/reflection method for permittivity measurement with one sample in coaxial line," *IEEE Transactions on Electromagnetic Compatibility*, vol. 53, no. 3, pp 684–689, August 2011.
- [8] C. L. Ziering, "Toppik enhances patient experience," *Hair Transplant Forum International*, vol. 13, no. 1, pp. 257, January 2003.
- [9] H. Zhou, G. Z. Lu, Y. F. Li, S. Wang, and Y. Wang, "An improved method of determining permittivity and permeability by *S* parameters," in *PIERS Proceedings, Beijing, China*, March 23-27, 2009, pp. 768–773.

Kok Yeow You (M'09) was born in 1977. He obtained his B.Sc. Physics (Honours) degree in Universiti Kebangsaan Malaysia (UKM) in 2001. He pursued his M.Sc. in Microwave at the Faculty of Science in 2003 and his Ph.D. in Wave Propagation at the Institute for Mathematical Research in 2006 in Universiti Putra Malaysia (UPM), Serdang, Selangor, Malaysia. Recently, he is a senior lecturer at Communication Engineering Department, Faculty of Electrical Engineering, Universiti Teknologi Malaysia (UTM), Skudai, Johor, Malaysia. His main personnel research interest is in the theory, simulation, and instrumentation of electromagnetic wave propagation at microwave frequencies focusing on the development of microwave sensors for agricultural and biomedical applications. Dr. You is a member of IEEE (2009 to recent), IEEE Microwave Theory and Techniques Society and IEICE (2011 to recent).

Yi Lung Then (S'13) was born in Kuching, Malaysia in 1988. He received the B.Eng degree (Hons.) in electrical engineering from Universiti Teknologi Malaysia (UTM), Skudai, Malaysia, in 2012, where he is currently pursuing the Ph.D. degree in electrical engineering in UTM.