

Permanent Magnet Synchronous Generator – Unsymmetrical Point Operation

P. Pistelok

Abstract—The article presents the concept of an electromagnetic circuit generator with permanent magnets mounted on the surface rotor core designed for single phase work. Computation field-circuit model was shown. The spectrum of time course of voltages in the idle work was presented. The cross section with graphically presentation of magnetic induction in particular parts of electromagnetic circuits was presented. Distribution of magnetic induction at the rated load point for each phase was shown. The time course of voltages and currents for each phases for rated power were displayed. An analysis of laboratory results and measurement of load characteristics of the generator was discussed. The work deals with three electromagnetic circuits of generators with permanent magnet where output voltage characteristics versus rated power were expressed.

Keywords—Permanent magnet generator, permanent magnets, vibration, course of torque, single phase work, asymmetrical three phase work.

I. INTRODUCTION

IN the present day, Industries of a rare earth magnets production is growing. Their use has grown considerably. One of the examples of using permanent magnets is synchronous electric machines. Depending on the application, these machines are designed and manufactured as motors or generators. The generators with permanent magnets, in comparison to the other machines, are characterized by the highest efficiency and highest power density per unit size [1]-[3]. These machines are widely used for specific operating conditions [4]-[10]. One of that kind applications, it may be three-phase synchronous generator intended for single phase work which was described in this article. The paper presents a computational model, the simulation results and the results of laboratory tests.

II. DESIGN SPECIFICATIONS

Three-phase generator was designed to single-phase work and each phase of this machine has different nominal values of phase voltages what was presented in Fig. 1. Phase vectors were shown in proportion to their values and they represent correct and adequate layout of rotating vectors in this generator. Value of rated phase voltage for each phase are the following $U_U = 400$ V, $U_V = 320$ V, $U_W = 240$ V. Each voltage value was specified based on the very specific working conditions of this machine. The idea of this unique system was presented in Fig. 2.

P. Pistelok work in the Institute of Electrical Drives and Machines KOMEL, Katowice, 40-203 Poland (phone: +4832 258 20 41 ext. 35; fax: +4832 259 99 48; e-mail: p.pistelok@komel.katowice.pl).

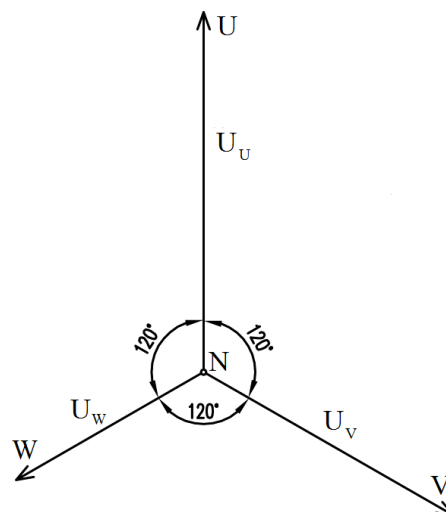

Fig. 1 Vector chart of phase voltages for permanent magnet generator in special design

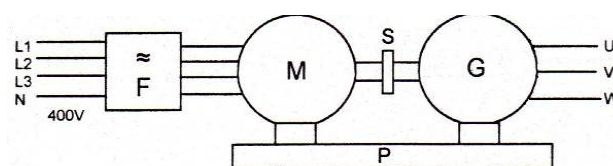

Fig. 2 Schematic representation of work ideas of permanent magnet generator in special design

Described generator is work as the electromechanical transducer for test transformer. Values of phase voltage were chosen due to the optimal work of the test transformer system. Generator G is powered by an asynchronous motor M. Electric motor M is powered and controlled by inverter F. Both machines are coupled together by coupling S and the whole system was placed on a common foundation P. The inverter is powered by 400 V three-phase line which allows to a smooth start-up, adjustment the frequency and voltage of asynchronous motor. The range of work frequency of inverter allows for generator work with frequency up to 150 Hz. Generator which work in that kind special conditions is the machine which need to be calculated with using finite element method. Computational model was worked out by using Maxwell 2D environment. The different load states of generator were calculated by using module of external circuits which allowed for changing connection configuration of generator (Fig. 3). In calculations, to simulate appropriate load state of each phase, the electric diagram presented in Fig. 3 was used with changing load resistance.

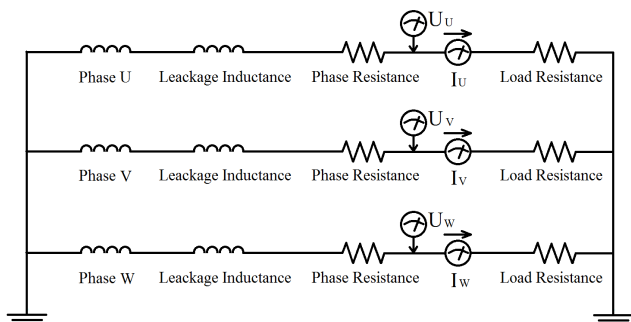

Fig. 3 Connection configuration of winding generator used in calculations

Generator which works in those kind special conditions is the machine which needs to be calculated with using finite element method. Computational model was worked out by using Maxwell 2D environment. The different load states of generator were calculated by using module of external circuits which allowed for changing connection configuration of generator (Fig. 3). In calculations, to simulate appropriate load state of each phase, the electric diagram presented in Fig. 3 was used with changing load resistance.

III. RESULTS – IDLE RUN

In Fig. 4 was shown magnetic flux distribution in the core of the machine. The presented flux lines prove that calculations and computational model were correctly worked out.

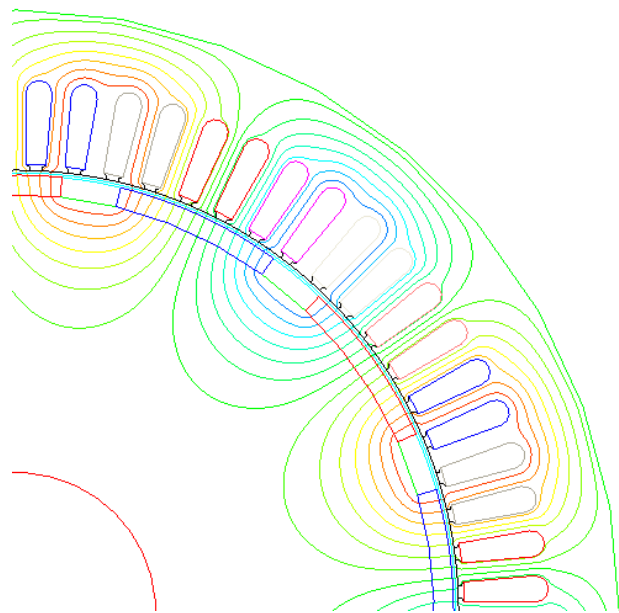

Fig. 4 The magnetic flux lines in core of permanent magnet generator in special design

In Fig. 5 the spatial distribution of magnetic flux for each phase was presented. As per requirements the flux of each phase has different value what gives different values of phase voltage for each phase.

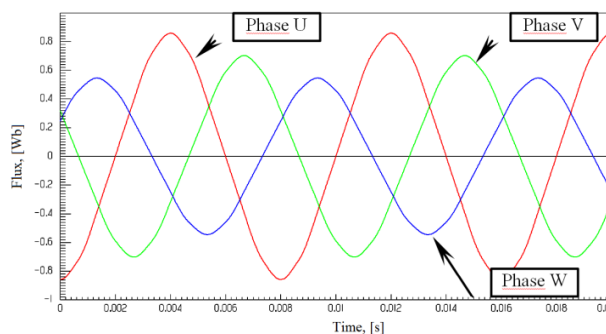

Fig. 5 Spatial distribution of magnetic flux for each phase of generator in special design

As shown in Figs. 5 and 6, the instantaneous values of the magnetic flux and phase voltages are different depending on selected phase what prove that the winding of generator was properly designed. In this project, the coefficients of Total Harmonic Distortion (THD) of induced voltages was calculated and presented. In the Figs. 7 and 8 spectrum waveforms at no load voltage of the generator were presented.

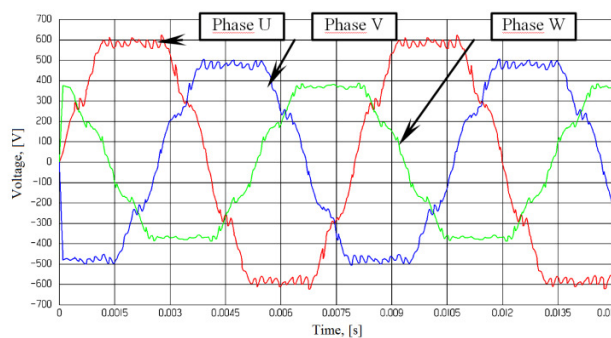

Fig. 6 Waveforms of the phase voltages in generator in special design

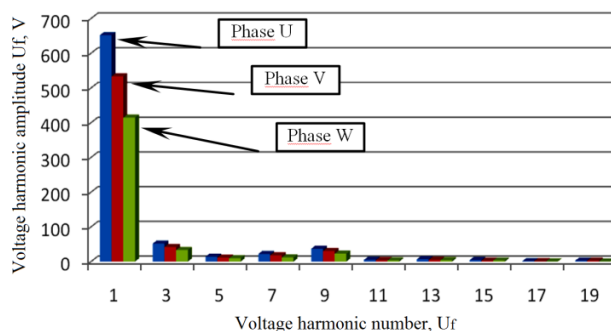

Fig. 7 Spectrum of phase voltage waveforms for each phase of generator in special design

In the spectrum of phase voltage waveforms (Fig. 7) it can be seen that the amplitude of the first harmonic is 651 V, and the amplitude of each harmonic does not exceed the level of 51 V, which is 7.8% with respect to the first harmonic of phase voltage. The low content of higher harmonics in the spatial distribution of flux density reduces the magnetic losses in iron core of generator, which has a positive effect on the efficiency of the machine.

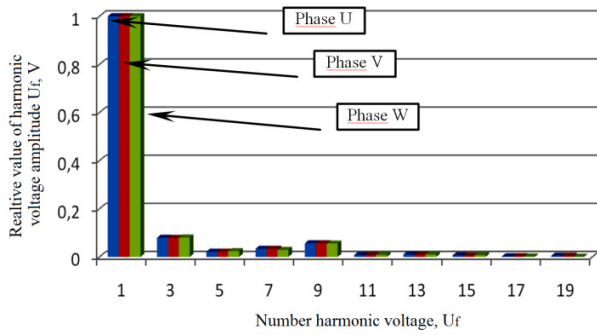

Fig. 8 Spectrum of phase voltage waveforms in relative units for each phase of generator in special design

As shown in Fig. 8, the number of harmonic in spectrum of phase voltage waveforms is the same for each presented phases. This fact tells that the operating conditions of each phase of generator are the same. Calculated coefficients of Total Harmonic Distortion of each phase are presented in Table I.

IV. RESULTS – LOAD STATE

Load state of generator was calculated with using external circuit module (Fig. 3) in Maxwell. To simulate different load state of generator, the value of load resistance for each phase was changed. Calculated waveforms of phase voltages and phase currents in load state of generator were shown in Figs. 9–14.

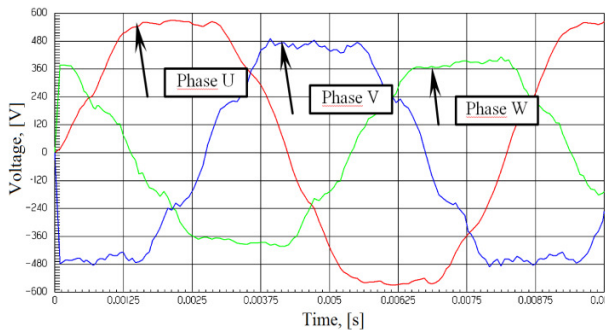

Fig. 9 Calculated waveforms of the phase voltages in load state of phase U

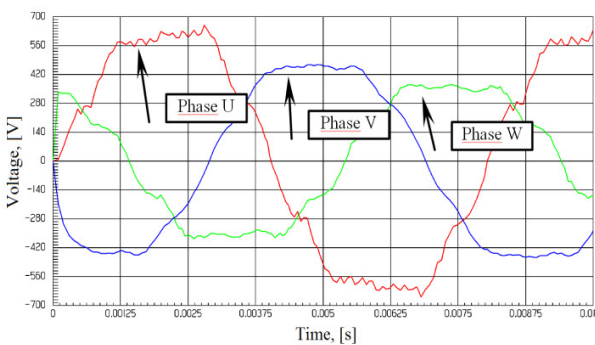

Fig. 10 Calculated waveforms of the phase voltages in load state of phase V

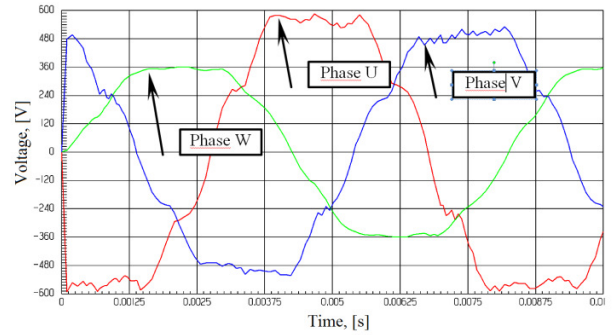

Fig. 11 Calculated waveforms of the phase voltages in load state of phase W

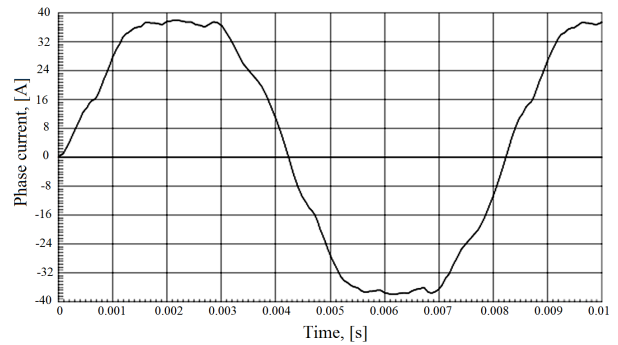

Fig. 12 Calculated waveforms of the phase current in load state of phase U

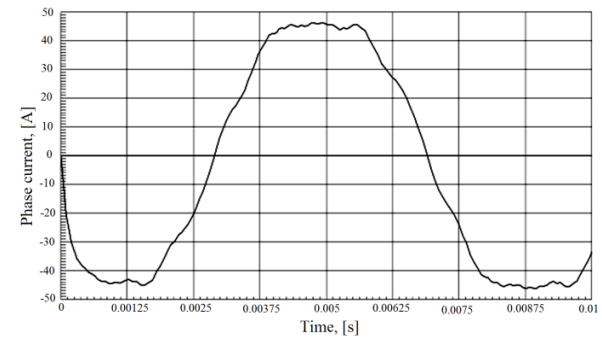

Fig. 13 Calculated waveforms of the phase current in load state of phase V

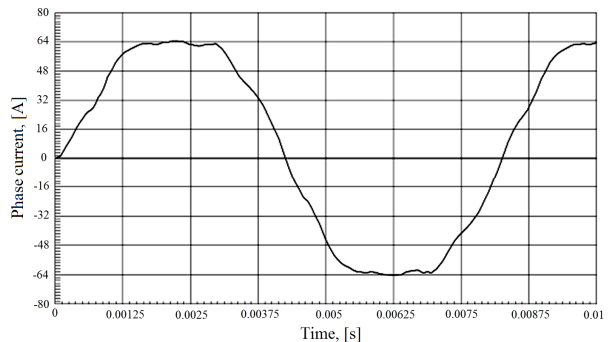

Fig. 14 Calculated waveforms of the phase current in load state of phase W

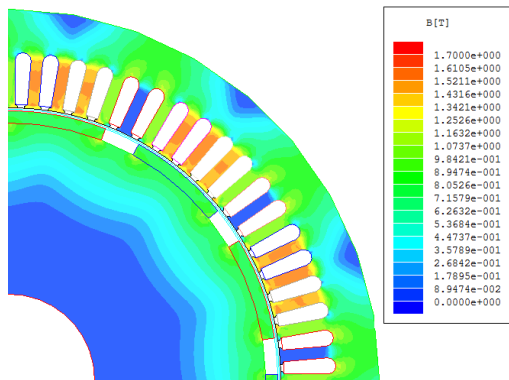

Fig. 15 Calculated distribution of magnetic induction in cross section of generator – load state of phase U

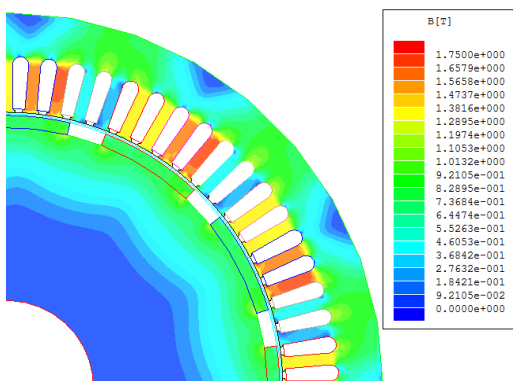

Fig. 16 Calculated distribution of magnetic induction in cross section of generator – load state of phase V

In Figs. 15-17 a graphical visualization of the distribution of magnetic flux density in cross-section was shown. The results of calculations for state load of each phase were presented. The value of magnetic induction in presented charts (Figs. 15-17) does not exceed value 1.7 T. That fact proved that whole electromagnetic circuit of generator was optimal designed. Due to the single-phase load operation of generator, the vibrations can be produced by asymmetric load of generator. The time course of electromagnetic torque is presented in Figs. 18-20 for each phase.

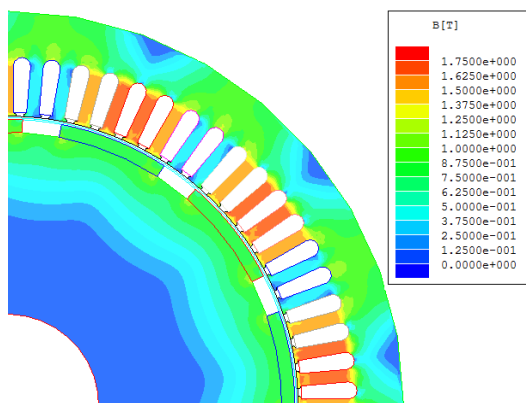

Fig. 17 Calculated distribution of magnetic induction in cross section of generator – load state of phase W

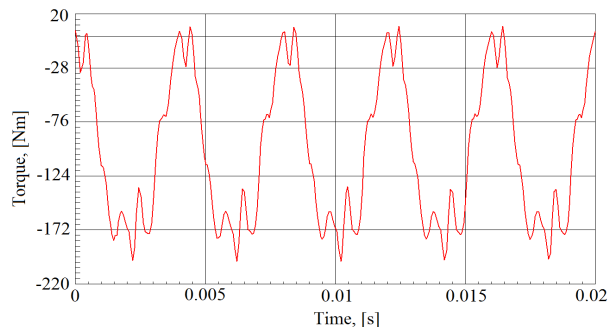

Fig. 18 Calculated waveform of electromagnetic torque – load state of phase U

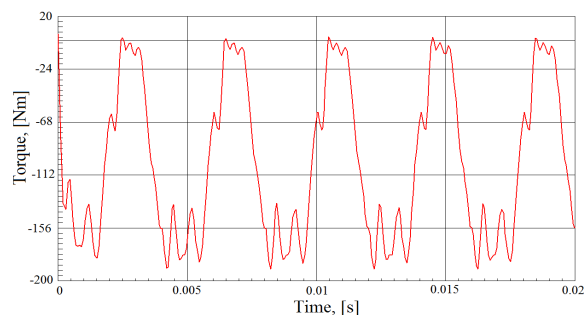

Fig. 19 Calculated waveform of electromagnetic torque – load state of phase V

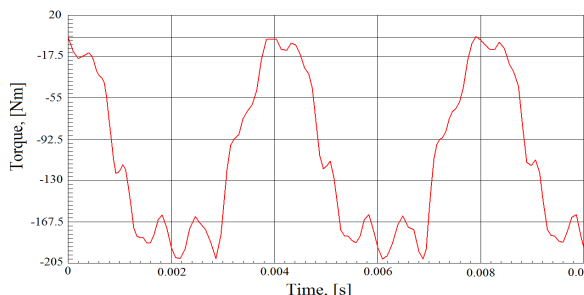

Fig. 20 Calculated waveform of electromagnetic torque – load state of phase W

As seen in Figs. 18-20, torque fluctuations appear in the machine in the range of 0 to about -200 Nm. In the time interval where the value of torque is close to zero the machine is not currently loaded (no load phase V and W) which results in a sudden increase in torque in the airgap of machine to the nominal value. Such a change in the value of torque is the cause of the vibration in the machine.

V. RESULTS – LABORATORY TESTS

The differences between calculated results and laboratory tests were presented in Table I. The generator was tested at a reduced speed (due to technical reasons), which was 1000 rpm. Designed speed of the generator is 1250 rpm. Rated power for each phase of the generator was calculate at 10 kW. To compare the results of the laboratory tests (Table I) with calculated values, parameters of generator were calculated for the lower speed and summarized in Table I.

TABLE I

PARAMETERS OF GENERATOR IN SPECIAL DESIGN FOR 1000 RPM

Parameter	Unit	Calculate	Laboratory tests
Phase U			
U_{fbj}	V	370,1	364,3
R_{20}	m Ω	209,4	213,5
$\cos \varphi$	-	1,0	0,83
U_f	V	320	339,3
I_f	A	25,0	24,5
$P_{elekt.}$	kW	8,0	7,0
THD_U	%	10,6	9,17
Phase V			
U_{fbj}	V	302,7	298,1
R_{20}	m Ω	133,3	137,0
$\cos \varphi$	-	1,0	0,83
U_f	V	256,0	274,1
I_f	A	31,2	30,5
$P_{elekt.}$	kW	8,0	7,0
THD_U	%	10,6	9,17
Phase W			
U_{fbj}	V	234,4	231,9
R_{20}	m Ω	84,8	88,6
$\cos \varphi$	-	1,0	0,83
U_f	V	192,0	206,5
I_f	A	41,7	42,5
$P_{elekt.}$	kW	8,0	7,3
THD_U	%	10,5	9,14

where: U_{fbj} – no-load operations phase induced voltage, R_{20} – phase resistance at 20° C, $\cos \varphi$ – power factor, U_f – rated phase voltage, I_f – rated phase current, $P_{elekt.}$ – rated power of generator, THD_U – total harmonic distortion of phase voltage. Test stand of generator was expressed in Fig. 21.

Due to the differences in the values of power factor (for laboratory tests and calculations) the power delivered by the generator is less than the calculated power. After adjusting for this difference, it can be stated that the generator reached the planned level of rated power. Fig. 22 presents the characteristics of the phase voltage as a function of power load on each phase of the generator.



Fig. 21 Test stand of generator in special design in electrical machines laboratory of KOMEL

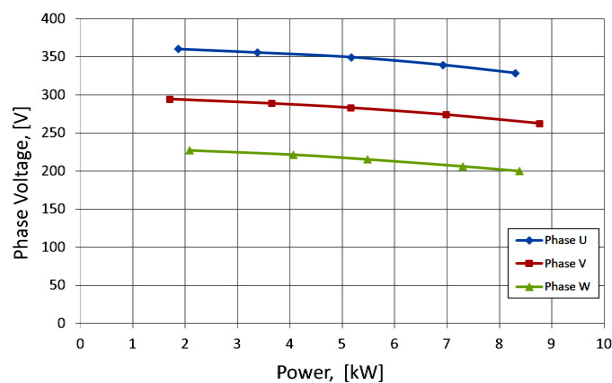

Fig. 22 Measured characteristics of phase voltages vs. power load of each phase of generator for 1000 rpm

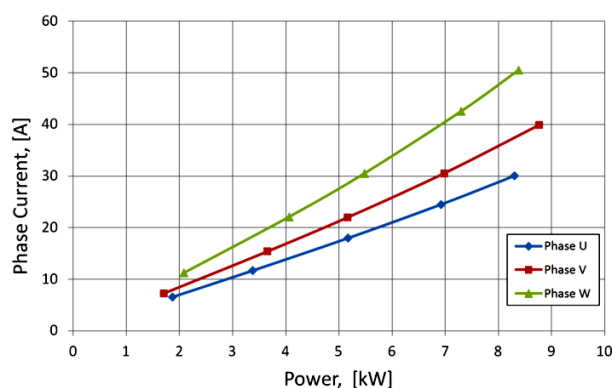

Fig. 23 Measured characteristics of phase currents vs. power load of each phase of generator for 1000 rpm

VI. SUMMARY AND CONCLUSIONS

The goal of this paper is to present three phase permanent magnet synchronous generator designed to single phase operation. Each phase of generator has different value of phase voltage, which allows to power supply single phase receivers with different rated voltage. The generator in special design can produce 10 kW from each phase with $\cos \varphi=1$. Presented in the article transient waveforms of magnetic flux and phase voltages (Figs. 5, 6) in the idle run of machine, provide a proper design of the generator windings in which each phase has a different phase voltage. The expressed waveforms of voltages and currents (Figs. 9-14) in load state of generator prove that the parameters of generator was properly calculated what was confirmed by laboratory tests (Figs. 22 and 23). Distribution of magnetic induction in particular parts of machine iron core is optimal what was confirmed by charts expressed in Figs. 15-17. The differences between results of laboratory tests and calculations are mainly due to:

- Characteristic of steel magnetization,
- Parameters of permanent magnets declared by manufacturer which has influence on fundamental induced voltage,
- Adopted temperature permanent magnets in calculations which has influence on characteristic induced voltage vs.

power load,

Despite achieving parameters of generator, as shown by laboratory tests, has a relatively high coefficient of total harmonic distortion, which reaches a value of 9%. Deformation of waveforms induced voltage of the generator was presented in Figs. 6, 9, 10 and 11. Designed and manufactured generator in special design is a single-phase power source with three different values of phase voltage. Waveforms of load torque in a single-phase load state of the generator are practically the same frequency of torque pulsations which varies in the range of 0 to about -200 Nm.

Depending on what the needs will be, the appropriate rated frequency of generator operation can be chosen, which is a good solution for power systems intended to examinations of voltage and current transformers. That kind of research stands can be used to analyze the electromagnetic phenomena occurring in the permanent magnet generator at universities of technology.

APPENDIX

Scientific work financed by state funds for science in 2013-2015, as a project No. 413/L-4/2012 named "Vibroacoustic diagnostic method of traction permanent magnets motors and generators based on the own signals" realized in Institute of Electrical Drives and Machines "KOMEL".

REFERENCES

- [1] Glinka T.: „Maszyny elektryczne wzbudzone magnesami trwałymi” Wydawnictwo Politechniki Śląskiej, Gliwice 2002.
- [2] Bernatt J.: „Obwody elektryczne i magnetyczne maszyn elektrycznych wzbudzonych magnesami trwałymi” Wydawnictwo KOMEL, Katowice 2010.
- [3] Pistelok P., Czaja T.: „Elektromechaniczna przetwornica częstotliwości” Zeszyty Problemowe Maszyny Elektryczne nr 2/2014 (102), Wydawnictwo KOMEL, Katowice 2014.
- [4] Rossa R., Król E.: „Modern electric machines with permanent magnet”. Przegląd Elektrotechniczny nr 12/2008.
- [5] Kisielewski P., Antal L.: „Praca turbogeneratora podczas zwarcia dwufazowego” Przegląd Elektrotechniczny nr 2b/2013.
- [6] Maljković Z., Žarko D., Stipetić S.: „Unsymmetrical load of a three-phase synchronous generator”. Przegląd Elektrotechniczny nr 2b/2013.
- [7] Radwański W., Będkowski B., Białas A., Rossa R.: „Koncepcja napędu elektrycznego „e-kit” dla miejskich samochodów osobowych” Zeszyty Problemowe Maszyny Elektryczne nr 4/2012 (97), Wydawnictwo KOMEL, Katowice 2012.
- [8] Glinka T., Wolnik T., Król E.: „Silnik tarczowy typu torus s-ns obliczenia obwodu elektromagnetycznego” Zeszyty Problemowe Maszyny Elektryczne nr 91/2011, Wydawnictwo KOMEL, Katowice 2011.
- [9] Dukalski P., Białas A., Radwański W., Będkowski B., Fręchowicz A.: „Koncepcja napędu z silnikiem BLDC o przelączalanej liczbie zwojów w napędzie samochodu elektrycznego”. Przegląd Elektrotechniczny 10.2013.
- [10] Hargreaves P.A., Mecrow B.C., Hall R.: „Open circuit voltage distortion in silent pole synchronous generators with damper windings” Power Electronics, Machines and Drives (PEMD 2010), 5th IET International Conference on, vol., no., pp.1-6, 19-21 April 2010.



P. Pistelok, M.Sc. was born in Świętochłowice in Poland in January 12th 1983. Graduated from the Silesian University of Technology in Gliwice in 2008 at the Faculty of Electrical Engineering, cathedral Electrical Machines, Electrical Engineering with a specialization in the direction of Electric Machines and Control Systems.

Since 2008 he has been working at the Institute of Electrical Machines and Drives, KOMEL in Katowice, as a research and technology specialist. He deals with the design of electrical machines and drives, including permanent magnet machines. He is co-author of publications as below:

J. Bernatt, P. Pistelok, E. Król, „Investigations on Efficiency Improvements of Electrical Propulsion System for a Light Airplane ” International Aegean Conference on Electric Machines and Power Electronics & Electromotion, IEEE Xplore, ACEMP 2011. P.Pistelok, R.Rossa “Highly efficient small hydropower stations”. Rynek Eenergii no 2(111), Kazimierz Dolny, Poland 2014.