

Robot Control by ERPs of Brain Waves

K. T. Sun, Y. H. Tai, H. W. Yang, H. T. Lin

Abstract—This paper presented the technique of robot control by event-related potentials (ERPs) of brain waves. Based on the proposed technique, severe physical disabilities can free browse outside world. A specific component of ERPs, N2P3, was found and used to control the movement of robot and the view of camera on the designed brain-computer interface (BCI). Users only required watching the stimuli of attended button on the BCI, the evoked potentials of brain waves of the target button, N2P3, had the greatest amplitude among all control buttons. An experimental scene had been constructed that the robot required walking to a specific position and move the view of camera to see the instruction of the mission, and then completed the task. Twelve volunteers participated in this experiment, and experimental results showed that the correct rate of BCI control achieved 80% and the average of execution time was 353 seconds for completing the mission. Four main contributions included in this research: (1) find an efficient component of ERPs, N2P3, for BCI control, (2) embed robot's viewpoint image into user interface for robot control, (3) design an experimental scene and conduct the experiment, and (4) evaluate the performance of the proposed system for assessing the practicability.

Keywords—Brain-computer interface (BCI), event-related potentials (ERPs), robot control, severe physical disabilities.

I. INTRODUCTION

In spite of the advances in technology has developed a variety of aids to help the limb disabilities in daily life. But mostly aids are still many restrictions on the operation, physical disabilities almost use body movements to trigger in order to complete the operation. However, severe physical disabilities unable to control the aids by body movements, thus helping these disabilities can independently go outdoors and enjoy the outside world, it is an unattainable fantasy. In this paper, we proposed a brain-computer interface (BCI) to control a robot by brain waves. In this way, severe physical disabilities can browse the outside world through the robot.

The electroencephalograph (EEG) is the most famous brain potential instrument, and this technology includes high temporal resolution, portability, and non-intrusive capture and so on. The non-invasive method for signal acquisition is an important goal of human brain development [1]. The weak signal of brain waves detected on the scalp by EEG, and the EEG signals are amplified and recorded for analysis. In 1965, Sutton first proposed event-related potentials (event-related potentials, referred to as ERPs) study provides a more objective

and simple and feasible approach [2]. Over the last decade, this technique has become quite popular and widely used technique in the observation of brain activity, has also been widely used in the various cognitive neuroscience [3]. The basic procedure of experiment design for event-related potentials is that the brain waves of a subject are recorded and accumulated through a serial of stimuli (for example: text, pictures, etc.) flashed on the computer screen and repeated on several times. After collecting the same stimulation, the reaction of brain can be more accurate presentation through averaging process. The components of ERPs, based on a specific stimulus, can be represented by P or N, following by a number, where P means the positive potential, N is the negative potential, and the number means the latency after stimulus [4]. For example, N200 means a negative potential of brain waves evoked about 200 milliseconds after stimulus. The P300 component of ERPs is characterized by one of the most common methods of BCI [5]–[8].

The basic idea of BCI is to interpret the brain signals into machine code or command, as a bridge links the human minds and the computer controls [9]. The BCI is used to control the operation of computer through the interpretation of the specific features of the brain waves such that people can communicate with outside world without voice or body movements. In this way, severe physical disabilities can operate the aids by BCI to communicate with others [10], [11]. The P300 spelling matrix BCI first proposed by Farwell and Donchin [12] is considered one of the classic BCI systems. It relies on the elicitation of the P300 through an oddball or rare paradigm of randomly intensified icon rows and columns [13], [14]. Another technique often used to BCI was N200-speller [15]. The neurophysiological characteristics of the N200-speller were compared with the classical P300-speller. The two paradigms elicit components with distinct spatio-temporal patterns. Experimental results revealed that the N200-speller achieved a comparable target detection accuracy with that of the P300-speller [16].

Fig. 1 shows the basic operation flow of BCI:

- (1) Signal capture: capture the brain signals from the electrode on scalp.
- (2) Digitization: amplify and digitize the brain signals.
- (3) Signal processing: extract and classify the features of brain signals, and generate a final result.
- (4) Issue a command: convert the classified results into a command for controlling the external facilities.

In recent years, technology has made significant advances in robotics. By using the brain computer interface to control the robot had been evaluated [17]. Many related researches to control equipments by brain waves had also developed [18]–[20]. However, the browse-based robot controlled by brain waves had not been developed. In this paper, we

K. T. Sun is a professor with the Department of Information and Learning Technology, National University of Tainan, Taiwan (phone: 886-6-2133111 Ext 773; e-mail: ktsun@mail.nutn.edu.tw).

Y. H. Tai is a graduate student with the Department of Information and Learning Technology, National University of Tainan, Taiwan (e-mail: sandrakeita05@hotmail.com).

H. W. Yang and H. T. Lin are both graduate students with the Department of Information and Learning Technology, National University of Tainan, Taiwan.

presented the technique of robot control by BCI. A specific component of ERPs, N2P3, was found and used to control the movement of robot and the view of camera on the designed BCI. Section II introduces the proposed method for robot control and the designed brain-computer interfaces. The experiment and results are described in Section III. Finally, we make a brief conclusion for this research and future applications of the proposed robot system.

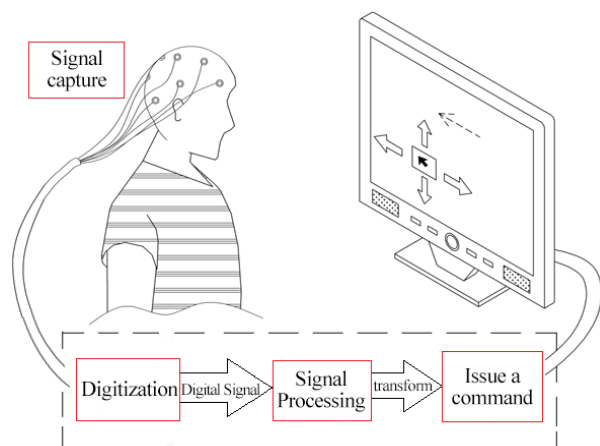

Fig. 1 Basic operation flow of BCI

II. METHODS

A. Robot Development System

Lego robot “Mindstorms NXT” is used as an example to develop a prototype of the brain control robot system. The characteristics of Mindstorms NXT are stated as follows.

- (1) Support multiple programming language developing environments: Mindstorms NXT can be freely assembled and be programmable by a variety of programming languages such as visual C++, visual C# and Borland C++, etc. In addition, it also supports the special development programming languages such as LabVIEW and NXT-G.
- (2) Support the Bluetooth wireless transmission: it can be operated on a computer through the Bluetooth wireless remote control.
- (3) Support the wireless video camera: a video camera can be mounted on robot and displayed the image on the computer screen by the 2.4GHz wireless transmission WS-VIDEO-USB receiver.

In this research, the view of the camera of robot is embedded in the BCI of the developed system, and the control system of robot and BCI were coded by Borland C++. Fig. 2 shows the assembled robot with the camera and Bluetooth system on the head.

B. Robot Control System

Based on our previous research results [21], [22], the brain signal located at the electrode O1 (visual cortex area) is used to control the robot by the generated visual evoked potentials.



Fig. 2 The assembled robot of the proposed system

Considering the accuracy, efficiency and user-friendly operation, we designed two operating interfaces: robot movement control and the camera control. A total of seven control buttons divided in these two interfaces (see Table I). Each button on the interface is alternately displayed a color bar moved from left to right as a stimulus. The user needs only to concentrate on the button of his/her choice with the intention in mind. The command of the button is triggered through the BCI’s analysis based on the captured brain waves. The duration of a stimulus is 0.16 seconds, and they are repeated 4 times with interval 0.4 seconds blank. There are about 2.2 seconds for generating a control command by the evoked potentials N2P3. The largest N2P3 (the difference in potentials between N200 and P300) among all stimuli of buttons is selected to induce the desired action of the button. Fig. 3 shows the user operating environment for robot control.









Fig. 3 User operating environment for robot control by brain waves

Figs. 4 and 5 show the operation interfaces for the movement of robot and the camera lens.

Fig. 6 shows the control flow of the proposed robot system. Initially, the robot is idle and starts to move after receiving a command from the user triggered by the brain waves. Three options can be selected: Go forward, Turn left and Turn right. These three options can be executed repeated until go to the state “Stop”. When the robot goes to “Stop” state, it will change to the camera control state after 2 seconds blank. Similarly, the control of camera lens is similar to the control of robot movement. When the robot reached to “Change to robot movement control” state, the system goes to the “Robot control” state again.

TABLE I
 THE CONTROL BUTTONS WITH THE CORRESPONDING COMMANDS

| Control buttons | Commands |
|---|--|
|  | Go forward |
|  | Turn right |
|  | Turn left |
| STOP | Stop movement & change to camera control interface |
|  | Rotate camera lens |
|  | Stop rotating camera lens |
|  | Change to robot control interface |

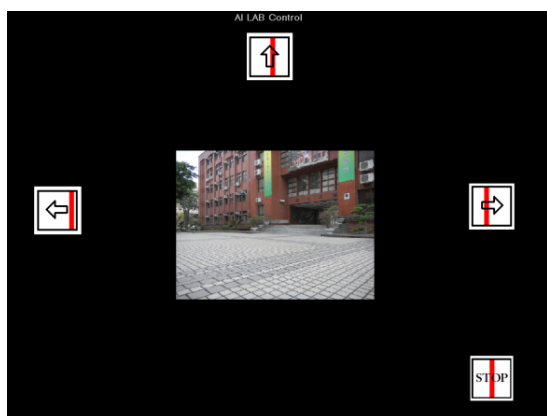

Fig. 4 The robot movement control interface

III. EXPERIMENTS

A. Participants

Our experiment had passed the review of institutional review board (IRB) and participants had signed the consent before experiment. Twelve healthy individuals between the ages of 21 and 29 ($M=22.6$, $SD\pm 1.62$), no brain disease, relevant medical history or drug abuse, and had normal or corrected-to-normal vision, voluntarily participated in the experiment.

B. EEG Recording

According to the results of our previous research [21], [22], the electrode O1 was the best position to capture the brain waves in the proposed system.

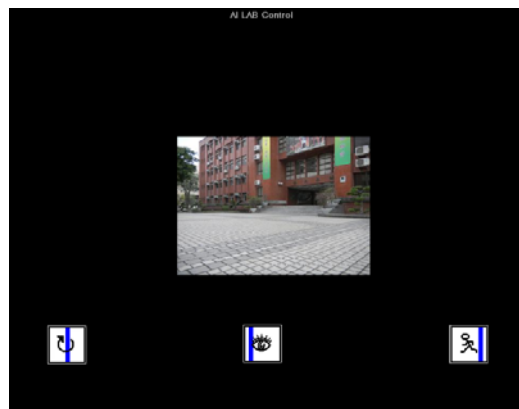

Fig. 5 The camera lens control interface

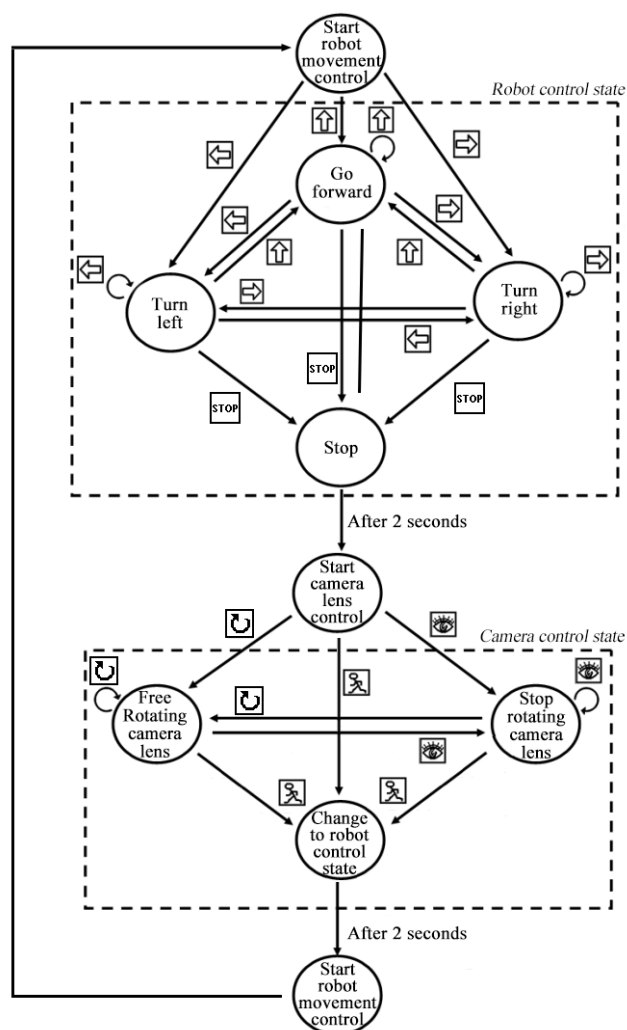

Fig. 6 The control flow of designed robot system

The brain waves captured from O1 by using EEG device: ISO-1032CE and CONTROL-1132 which were produced by Braintronics B.V. The sample rate is 1024Hz/channel with band-pass filtered 0.5–50 Hz. The BCI system and robot control system were coded by Borland C++. Based on a spelling matrix experiment, we found the component N2P3 had

the most significant level. Table II showing differences in amplitude between target and non-target from t-test results reveals that the amplitudes of not only N200 and P300, but also of N2P3, are significant in both columns ($p < 10^{-16}$) and rows ($p < 10^{-8}$).

TABLE II

THE DIFFERENCE BETWEEN TARGETED AND NON-TARGETED COLUMNS AND ROWS AT N200, P300 AND THE RANGE BETWEEN THE TWO, N2P3 FOR A 4 X 3 MATRIX. THE DIFFERENCE IN N2P3 IS MORE SIGNIFICANT THAN EITHER N200 OR P300 ALONE

| | | | Mean | SD | t | sig. |
|--------|------|--------------|--------|-------|--------|----------------|
| Column | N200 | Targeted | -2.745 | 2.263 | -4.169 | $<10^{-4***}$ |
| | | Non-Targeted | -0.784 | 2.220 | | |
| | P300 | Targeted | 4.700 | 2.565 | 5.958 | $<10^{-7***}$ |
| | | Non-Targeted | 1.576 | 2.462 | | |
| | N2P3 | Targeted | 7.257 | 3.155 | 9.784 | $<10^{-16***}$ |
| | | Non-Targeted | 2.289 | 2.109 | | |
| Row | N200 | Targeted | -2.215 | 1.699 | -3.349 | 0.0005** |
| | | Non-Targeted | -0.727 | 2.115 | | |
| | P300 | Targeted | 3.836 | 2.824 | 3.611 | 0.0002** |
| | | Non-Targeted | 1.772 | 2.413 | | |
| | N2P3 | Targeted | 6.061 | 3.349 | 5.857 | $<10^{-8***}$ |
| | | Non-Targeted | 2.811 | 2.352 | | |

* $p < .01$ ** $p < .001$ *** $p < .0001$

C. Procedure of Experiment

After reading the instructions of the experiment, the participant signed the consent and prepared to start the experiment. Then the electrode O1 was pasted and did a simple test to make sure that captured brain waves were normal. After confirmation, we asked the participant to practice the brain control by focus on one of the buttons to move the robot and the view of camera. After 5 minutes practice, we assigned a mission to the participant to complete a task in a designed scene to evaluate the performance of overall system.

Initially, a poker card is fixed on the chest of the robot, and cannot be seen by the participant. The participant wants to control the robot to move in the scene and to find out the pattern of the card at the destination (a mirror placed at destination). The designed scene contains two roads, and connected to a "T" type (see Fig. 7). There is a sign at the junction of these two roads that uses to indicate the destination direction. When the robot moves to the destination, a mirror is placed there. Then, the participant can see the pattern of the card in front of the robot by mirror (see Fig. 8). If the participant cannot finish the task within 15 minutes, then the mission failed.

After the experiment, participants were requested to fill in a questionnaire, including the burden of concentration, ease of operation, the degree of satisfaction about the system operating procedure, interface and completing the mission.

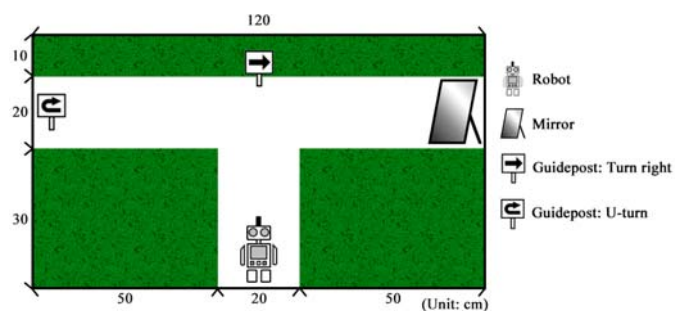

Fig. 7 The designed scene of experiment



Fig. 8 The image of mirror showed the pattern of card at the destination

D. Experiment Results

All participants finished the mission within 15 minutes. Experimental results showed that the accuracy of brain control achieved above 82% during practice phase, and the averaged accuracy about 80% during test phase for completing the mission. The accuracy of each participant is shown in Table III.

The questionnaire uses 5-point Likert scale, ranking from "1 = strongly disagree" to "5 = strongly agree". Three types of questions included: "do you feel the burden of concentration is suitable?", "do you feel the operation is easy?", and "do you feel the satisfaction is great?" Results of questionnaire showed that most participants felt very well in the brain control robot experiment (see Table IV), and the averaged scores of these three-type questions are 4.2–4.8.

IV. CONCLUSIONS

In this research, we designed a brain control robot system which can control the movement of robot and the view of camera by brain waves. By retrieving the component N2P3 of ERPs, the user can efficiently control the operation of equipment by brain waves. An experiment scene was designed to evaluate the performance of the proposed system by the accuracy of issued commands and execution time of completing the mission. Twelve volunteers participated in this experiment, and experimental results showed that the correct rate of BCI control achieved 80% and the average of execution time was 353.3 seconds for completing the mission. Most participants felt well after experiment, and had high scores (4.2–4.8) among three types of questions included: "do you feel the burden of concentration is suitable?", "do you feel the

operation is easy?", and "do you feel the satisfaction is great?" This research had achieved four contributions: (1) find an efficient component of ERPs, N2P3, for BCI control, (2) embed robot's viewpoint image into user interface for robot control, (3) design an experimental scene and conduct the experiment for brain control robot system, and (4) evaluate the performance of the proposed system for assessing the practicability. The proposed system would be also applied to the healthcare system or smart home control system for reducing the need for human resources. The proposed technique has a wide range of applications that would promote a higher quality life of independent living for severe physical disabilities.

TABLE III
EXPERIMENTAL RESULTS OF ROBOT CONTROL AMONG 12 PARTICIPANTS

| Subject ID | No. of correct commands | No. of issued commands | Accuracy (%) | Completion time (seconds) |
|------------|-------------------------|------------------------|--------------|---------------------------|
| S1 | 12 | 15 | 80 | 194 |
| S2 | 14 | 18 | 78 | 250 |
| S3 | 40 | 54 | 74 | 750 |
| S4 | 28 | 31 | 90 | 414 |
| S5 | 16 | 24 | 68 | 343 |
| S6 | 10 | 14 | 71 | 190 |
| S7 | 9 | 9 | 100 | 134 |
| S8 | 33 | 47 | 70 | 672 |
| S9 | 41 | 60 | 68 | 853 |
| S10 | 15 | 19 | 79 | 256 |
| S11 | 12 | 14 | 86 | 192 |
| S12 | 15 | 17 | 88 | 144 |
| Mean | 20.42 | 26.33 | 80.08 | 353.33 |
| SD | 11.77 | 16.67 | 9.22 | 236.54 |

TABLE IV
QUESTIONNAIRE'S RESULTS AMONG 12 PARTICIPANTS

| Subject ID | Burden of concentration | Ease of operation | The degree of satisfaction |
|------------|-------------------------|-------------------|----------------------------|
| S1 | 4 | 5 | 5 |
| S2 | 4 | 5 | 5 |
| S3 | 4 | 4 | 4 |
| S4 | 4 | 5 | 5 |
| S5 | 4 | 5 | 5 |
| S6 | 4 | 5 | 5 |
| S7 | 5 | 5 | 5 |
| S8 | 4 | 4 | 4 |
| S9 | 4 | 4 | 3 |
| S10 | 4 | 5 | 5 |
| S11 | 5 | 5 | 5 |
| S12 | 5 | 5 | 5 |
| Mean | 4.25 | 4.75 | 4.67 |
| SD | 0.45 | 0.45 | 0.65 |

ACKNOWLEDGMENT

This work was partially supported by the National Science Foundation of Taiwan (Project ID: 102-2815-C-024-023-S).

REFERENCES

[1] K. Saravanan and H. Mahalakshmi, "Brain-computer control of wheelchair concluded mobile robot," *International Journal of Advanced Research in Robotics and Development*, vol. 1, no. 1, pp. 1–5, 2013.

[2] S. Sutton, M. Braren, J. Zubin, and E. R. John, "Evoked-potential correlates of stimulus uncertainty," *Science*, vol. 150, no. 3700, pp. 1187–1188, 1965.

[3] M. Kutas and S. A. Hillyard, "Reading senseless sentences: Brain potentials reflect semantic incongruity," *Science*, vol. 207, no.4427, pp. 203–205, 1980.

[4] E. Donchin, K. M. Spencer, and R. Wijesinghe, "The Mental Prosthesis: Assessing the Speed of a P300-Based Brain-Computer Interface," *IEEE Transactions on Rehabilitation Engineering*, vol. 8, no. 2, pp. 174–179, 2000.

[5] Y. H. Liu, H. P. Huang, T. H. Huang, Z. H. Kang, and J. T. Teng, "Controlling a Rehabilitation Robot with Brain-Machine Interface: An approach based on Independent Component Analysis and Multiple Kernel Learning," *International Journal of Automation and Smart Technology*, vol. 3, no. 1, pp. 67–75, 2013.

[6] Y. Su, J. Dai, X. Liu, Q. Xu, Y. Zhuang, W. Chen, and X. Zheng, "EEG channel evaluation and selection by rough set in P300 BCI," *Journal of Computational Information Systems*, vol. 6, no. 6, pp. 1727–1735, 2010.

[7] D. V. Renterghem, B. Wyns, and D. Devlaminck, "Shared control between P300 BCI and robotic arm," *International Journal of Bioelectromagnetism*, vol. 13, no. 1, pp. 2–4, 2011.

[8] I. H. Hasan, A. R. Ramli, S. A. Ahmad, and R. Osman, "P300-Based EEG Signal Interpretation System for Robot Navigation Control," *World Applied Sciences Journal*, vol. 26, no. 5, pp. 566–572, 2013.

[9] W. Chen, J. Zhang, Y. Li, Y. Qi, Y. Su, B. Wu, S. Zhang, J. Dai, and X. Zheng, "A P300 based online brain-computer interface system for virtual hand control," *Journal of Zhejiang University SCIENCE C*, vol. 11, no. 8, pp. 587–597, 2010.

[10] N. Birbaumer, "Breaking the silence: Brain-computer interfaces (BCI) for communication and motor control," *Psychophysiology*, vol. 43, no. 6, pp. 517–532, 2006.

[11] B. Hong, F. Guo, T. Liu, X. Gao, and S. Gao, "N200-speller using motion-onset visual response," *Clinical Neurophysiology*, vol. 120, no. 9, pp. 1658–1666, 2009.

[12] L. A. Farwell, and E. Donchin, "Talking off the top of your head: toward a mental prosthesis utilizing event-related brain potentials," *Electroencephalogr Clin. Neurophysiol.*, vol. 70, no. 6, pp. 510–23, 1988.

[13] J. N. Mak, D. J. McFarland, T. M. Vaughan, L. M. McCane, P. Z. Tsui, D. J. Zeitlin, E. W. Sellers, and J. R. Wolpaw, "EEG correlates of P300-based brain-computer interface (BCI) performance in people with amyotrophic lateral sclerosis," *J. Neural Eng.*, vol. 9, no. 2:026014, 2012.

[14] R. Fazel-Rezai, B. Z. Allison, C. Guger, E. W. Sellers, S. C. Kleih, and A. Kübler, "P300 brain computer interface: current challenges and emerging trends," *Front. Neuroeng.*, vol. 5, doi: 10.3389/fneng.2012.00014, July 2012.

[15] D. Zhang, H. Song, H. Xu, W. Wu, S. Gao, and B. Hong, "An N200 speller integrating the spatial profile for the detection of the non-control state," *Journal of Neural Engineering*, vol. 9, No. 2, doi:10.1088/1741-2560/9/2/026016, 2012.

[16] B. Hong, F. Guo, T. Liu, X. Gao, S. Gao, "N200-speller using motion-onset visual response," *Clin. Neurophysiol.*, vol. 120, pp. 1658–66, Sep 2009.

[17] L. Tonin, E. Menegatti, M. Cavinato, C. D'Avanzo, M. Pirini, A. Merico, L. Piron, K. Priftis, S. Silvoni, C. Volpato, and F. Piccione, "Evaluation of a robot as embodied interface for brain computer interface systems," *International Journal of Bioelectromagnetism*, vol. 11, no.2, pp. 97–104, 2009.

[18] P. Belluomo, M. Bucolo, L. Fortuna, and M. Frasca, "Robot Control through Brain-Computer Interface for Pattern Generation," *Complex Systems*, vol. 20, no. 3, pp. 243–251, 2012.

[19] T. Carlson and J. del R Millan, "Brain-controlled wheelchairs: a robotic architecture," *IEEE Robotics and Automation Magazine*, vol. 20, no. 1, pp. 65–73, 2013.

[20] R. Singla and B. A. Haseena, "BCI-based wheelchair control using steady state visual evoked potentials and support vector machines," *International Journal of Soft Computing and Engineering*, vol. 3, no. 3, pp. 46–52, 2013.

[21] K. T. Sun, T. W. Huang, and M. C. Chen, "Design of Chinese spelling system based on ERPs," in *Proc. 11th IEEE International Conference on Bioinformatics and Bioengineering*, Taichung, Taiwan, 2011, pp. 310–313.

[22] K. T. Sun, T. W. Huang, M. C. Chen, and Y. C. Li, "Design of Chinese spelling system," in *Proc. 2nd Annual International Conference on Advanced Topics in Artificial Intelligence*, Fort Canning, Singapore, 2011, pp.26–31.