

A New Design of Permanent Magnets Reluctance Generator

Andi Pawawoi, Syafii

Abstract—Instantaneous electromagnetic torque of simple reluctance generator can be positive at a time and negative at other time. It is utilized to design a permanent magnet reluctance generator specifically. Generator is designed by combining two simple reluctance generators, consists of two rotors mounted on the same shaft, two output-windings and a field source of the permanent magnet. By this design, the electromagnetic torque on both rotor will be eliminated each other, so the input torque generator can be smaller. Rotor is expected only to regulate the flux flow to both output windings alternately, until the magnetic energy is converted into electrical energy, such as occurs in the transformer energy conversion. The prototype trials have been made to test this design. The test result show that the new design of permanent magnets reluctance generator able to convert energy from permanent magnets into electrical energy, this is proven by the existence 167% power output compared to the shaft input power.

Keywords—Energy, Magnet permanent, Reluctance generator.

I. INTRODUCTION

ONE source of new and renewable energy has recently discovered is a permanent magnet. Permanent magnet is long known and used in various fields of electrical engineering, for example, dynamos, motors, speakers, etc. However, its use as an energy source, newly discovered, and these energy conversion devices currently no commercially produced.

Previous studies, associated with the permanent magnet, showed that the permanent magnet can be used as an energy source. The energy conversions from permanent magnets have been done [1], which made Parendev Permanent Magnet Motor (PPMM). Accordance with its name, this engine produces mechanical rotation energy derived from permanent magnet energy of motor that build it. Several other researchers also have made a permanent magnet motor with a different design from the motor Varendev.

Research to get a permanent magnet machine energy conversion into electricity is very promising and gives great hope. A study aimed to get a permanent magnet machine energy conversion into electrical energy has been studied in [2] as pioneered research. In that study successfully designed a New Model Reluctance Generator (NMRG) with excess capable of converting energy from a constant magnetic field into electric energy. NMRG output energy is not reflected by the input shaft, but from given constant input fields. In the

conducted experiments, when NMRG loaded at different load levels, the input power was constant, and the power was same as the generator in no-load conditions. However, the changes according to the load change are the power input field excitation. It shows that there has been a conversion of energy from the generator field source into electrical energy [2].

The next problem to be studied is to develop design NMRG, by changing the source field from the coil electric DC current into permanent magnet. This NMRG development targets, is obtained an engine design that is able to convert energy from permanent magnet into the electrical energy.

II. BASIC THEORY

A. Simple Reluctance Generator

Reluctance generator is a generator that utilizes the air gap reluctance changes due to rotation of the rotor to generate voltage. At this generator, both field winding and armature fixed and operations depend on the period of the air gap changes. The generator is allowed to be operated at high speed to generate a voltage, typically used as a wind turbine or micro gas turbine generator.

Fig. 1 shows the operating principle of a simple reluctance generator. Two permanent magnets are placed on the stator core, serves as a major source of field. A salient pole rotor is made of silicon steel. Stator windings are placed on poles. When the rotor rotated, the reluctance changes will occur in the core of the stator flux changes along with changes in the position of the rotor. Because the flux changes are summarized by the stator winding on the winding voltage will be induced [3], [4].

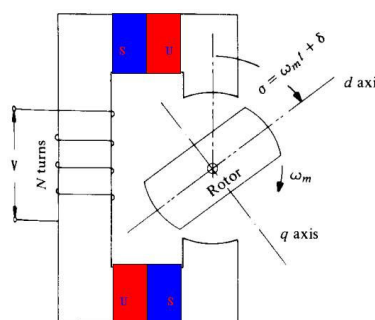

Fig. 1 Simple reluctance generator

By considering simple reluctance motors as shown in Fig.1, which is a function of the assumed magnetic rotor position angle by (1) and the graph illustrated in Fig. 2.

Andi Pawawoi is with the Electrical Engineering Department, Andalas University, Padang, Indonesia (e-mail: andi_wawo@ft.unand.ac.id).

Syafii is with the Electrical Engineering Department, Andalas University, Padang, Indonesia (e-mail: Syafii@ft.unand.ac.id)

$$R = \frac{1}{2}(R_d + R_q) - \frac{1}{2}(R_q - R_d) \cos 2\sigma \quad (1)$$

Emf induced is generated in the windings if the resistance is negligible:

$$e = v \approx \sqrt{2} V \cos \omega t = N \frac{d\phi}{dt} \quad (2)$$

wherein:

$$\phi = \phi_M \sin \omega t \quad (3)$$

and

$$\phi_M = \frac{V}{4.44 f N} = \frac{\sqrt{2}V}{2\pi f N} = \frac{\sqrt{2}V}{\omega N} \quad (4)$$

Electromagnetic torque simple of reluctance generator expressed by (5) and the graph illustrated in Fig. 2 [4], [6], [7].

$$T_{em} = -\frac{1}{2} \phi^2 \frac{dR}{d\sigma} \quad (5)$$

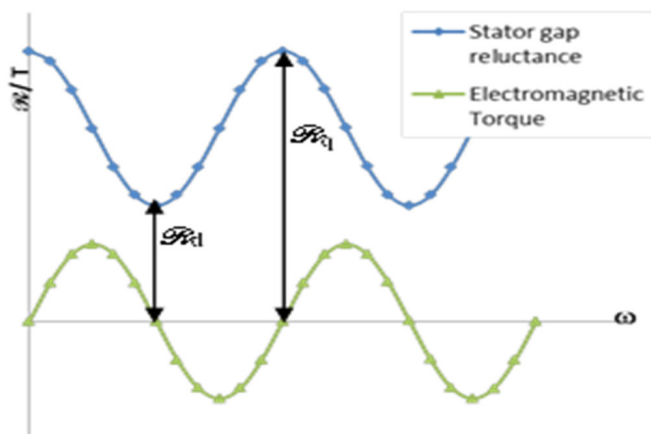

Fig. 2 The relationship between reflectance and torque vs. rotor position

B. Permanent Magnet

Permanent magnet is a material that able to generate its own magnetic field without energy supply, in contrast to the winding can generate magnetic fields only if there is electrical energy supplied (voltage and current). The magnetic field is a form of energy. The magnetic field of the permanent magnet has the same character with the magnetic field generated from electrical current-carrying winding [5].

The ability of permanent magnet moving mass of a body of evidence ferromagnetic hat proves permanent magnets have the real energy. Energy in permanent magnets has not been widely used. On conventional generators / motors, permanent magnet is used as an imaginary energy source only.

Permanent magnets are generally made of a mixture metal and or non-metal created by buffed with another magnet in the same direction, induced magnet, or magnetic material is placed in a solenoid (a long tubular coil of wire with very tightly turned) and electrified by direct current (DC).

Currently there are several types of permanent magnets include: n Neodymium magnets, samarium-cobalt magnets, ceramic magnets, plastic magnets, alnico magnets, ferrite

magnets, etc.

The permanent magnet shape can be adjusted as needed. The form a permanent magnet available is: U magnet, horseshoe magnet, rod magnet, circles magnet, etc.

The magnetic properties of permanent magnets can be eliminated by means of, among other things: burned, slam-slam, pounded, or placed on the solenoid magnet and electrified by alternating current.

III. METHOD

A. Design of Permanent Magnet Reluctance Generator

1. Design of Rotor

Rotor of the generator, designed according to Fig. 3. It consists of 2 pieces and both are connected by a shaft with a different angle of 180° as shown in Fig. 4. By this way the electromagnetic torque of the two rotors are able to reduce. The rotor which made of silicon steel laminations is arranged radials intended to reduce eddy current losses in the rotor.

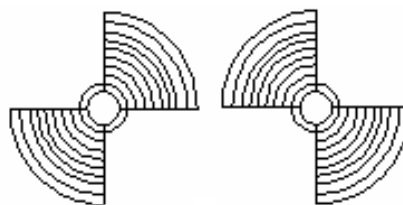

Fig. 3 Design of rotor

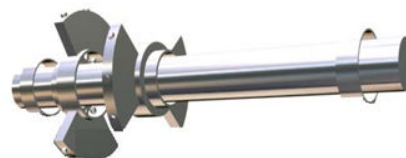

Fig. 4 Composite rotor

By rotor designed above, the electromagnetic torque of each rotor is a different phase of 180°, so that the total sum of both rotor electromagnetic torques's will be zero.

2. Design of Stator

The generator stator consists of 3 main parts: stator core, permanent magnet and armature windings. Fig. 5 shows a sketch of stator design. Stator core made of laminated silicon steel U-shaped, with each core leg right and left mounted armature windings which are the output voltage V_{out1} and V_{out2} are generated with different angle 180°.

In the middle of arrangement plate, mounted permanent magnet is served as a major source of field so that in the stator formed 2 stator gaps i.e. left and right gap, as shown in Fig. 5. At this gap will be mounted rotor.

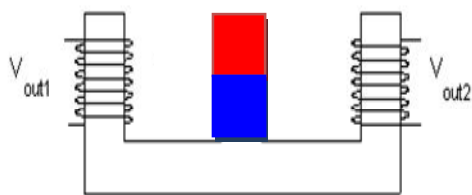

Fig. 5 Stator design

3. Design of Combined Stator and Rotor

Rotor that has been made is placed in the contained gap at the stator. In this generator design, the magnitude of the air gap must be considered because effecting on the flux flow result (Fig. 6). The air gap between the rotor and stator kept minimum to achieve small reluctance, while between the shaft and the stator should not be too close so that the flux does not pass through the shaft.

If the rotor is rotated past the stator gap, when the rotor is right on the stator gap (Fig. 6), the flux from the permanent magnet will flow through the rotor and into the stator core. Line with the movement of the rotor through the stator gap, the magnetic flux passing through the stator winding core will change from the minimum value before the rotor into the stator gap until it reaches the maximum value when the stator gap is closed by the rotor, and this value will be returned to its minimum value when the rotor exit of stator gap. This condition occurs alternately on both core winding.

Magnetic flux changes as described above occur because of changes in Reluctance stator gap. The resulting flux from the permanent magnet will tend to flow on the section that has a low Reluctance values. Minimum Reluctance value of stator gap will occur when the rotor is directly on the gap, at the time of flux flow will reach its maximum value. The maximum reluctance occurs when the rotor outside the stator gap, at the time the flux reaches its minimum value. Graphically it can be represented as shown in Fig. 7.

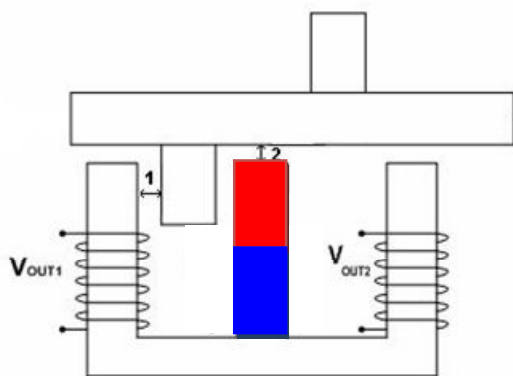

Description:

- 1 = air gap between stator-rotor
- 2 = air gap between the stator-shaft

Fig. 6 Model of permanent magnet reluctance generator

According to (5), the electromagnetic torque on both rotors can be described as shown in Fig. 7. From the picture shown

that if both torque summed the result is equal to zero. This means that if the two rotors mounted on the same shaft then there would be no electromagnetic torque on the rotor shaft.

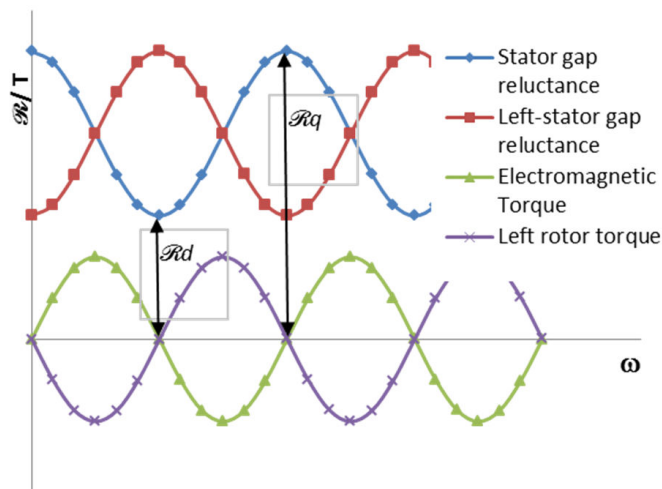

Fig. 7 Reluctance and electromagnetic torque in a permanent magnet reluctance generator new design

B. Generator Voltage

Due to the change in flux in the core of the armature windings are placed where it will be raised the voltage on the armature windings. To determine the maximum total flux windings, necessary to determine the broad surface of the rotor and stator assembly are effective through the magnetic flux. The maximum effective area occurs when the rotor is right on the stator gap; in this condition the magnitude of the magnetic flux reaches its maximum. The equation used to calculate the area, is the equation of a circle sector wide. For more details can be seen in the Fig. 8 below.

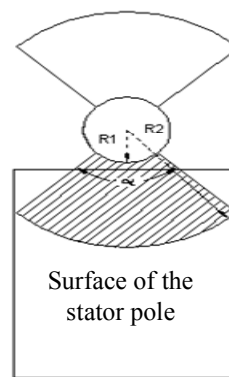

Fig. 8 The effective area crossed magnetic flux

Effective area is approximated by the equation:

$$A = \frac{\pi}{360^\circ} (r^2) \alpha^0 \quad (6)$$

where: A = Effective surface area (m²)

$\pi = 3.14$

$r = R_2 - R_1$ (m)

α = Angle (degrees)

Effective areas are used to calculate the reluctance between the stator and the rotor with the following equations:

$$\mathcal{R} = \frac{l}{\mu A} \quad (7)$$

$$\mu = \mu_r \mu_0 \quad (8)$$

where: \mathcal{R} = Reluctance (A. turn/Weber)

l = Path length (m)

A = Surface area (m²)

μ = Permeability (H/m)

μ_r = Material permeability

μ_0 = Vacuum permeability

The values that have been obtained are used to calculate the magnitude of the magnetic flux and flux density according to the following equation:

$$\phi = \frac{\mathcal{F}}{\mathcal{R}} \quad (9)$$

$$B = \frac{\phi}{A} \quad (10)$$

where: ϕ = Magnetic flux (Weber)

\mathcal{F} = Mmf (A. Turn)

B = Flux density (Weber/m²)

The voltage generated can be calculated using the following equation:

$$e = -N \frac{\partial \phi}{\partial t} \quad (11)$$

where:

$$\phi = BA \quad (12)$$

So that:

$$e = -N \frac{BdA}{dt} = -N \frac{Brd\theta}{dt} \quad (13)$$

where:

$$\frac{d\theta}{dt} = \omega ; \text{ kecepatan sudut}$$

So that:

$$e = -N \cdot B \cdot r \cdot \omega \quad (14)$$

C. Dimensional Trial Prototype

To test the above generator design, the trial generator is created with the rotor and stator dimensions as shown in Figs. 9 and 10 below.

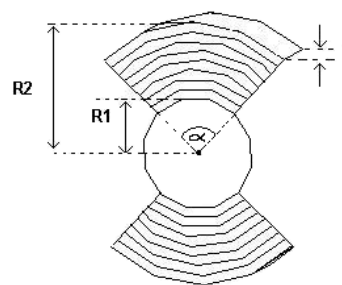

Fig. 9 Specifications rotor
 $R_1 = 3 \text{ cm}$, $R_2 = 5.7 \text{ cm}$, $L = 2.4 \text{ cm}$, $\alpha = 90^\circ$

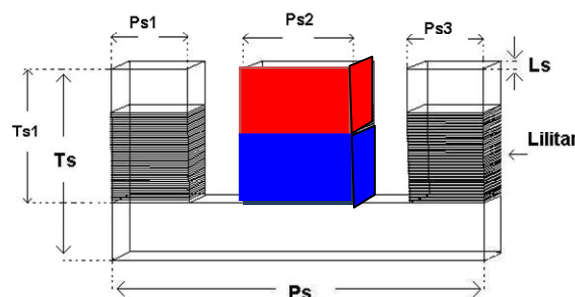

Fig. 10 Specifications stator
 $P_s = 15.2 \text{ cm}$, $T_s = 10.1 \text{ cm}$, $L_s = 6.3 \text{ cm}$, $P_{s1} = P_{s3} = 2.5 \text{ cm}$, $P_{s2} = 5 \text{ cm}$, $T_{s1} = 7.6 \text{ cm}$, Number of winding = 530 turn, Size of copper = 0.5 mm

D. Permanent Magnet

Permanent magnets are used in this design are grade N35 neodymium magnets with length 22mm, width 13mm and thickness of 2.5mm, a total of 90 pieces arranged to form a 3x3 matrix as high as 15 pieces. The magnetic field generated from the permanent magnet in the air can be seen in Fig. 11 below:

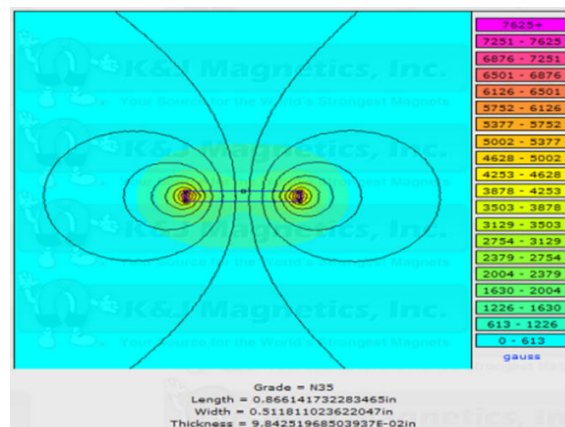

Fig. 11 Magnetic flux of neodymium magnet N35

E. Simulation of Magnetic Flux

The proposed design, ideally desired all magnetic flux from the permanent magnet applied to the right and left leg of stator core, alternately. The leakage flux is undesired, such as the flux that flows into the left side core when all flux is directed

by rotor to the right side core. To minimize the flux leakage magnetic flux mapping needs to be done so that the design could be made more perfect.

The simulation of magnetic field mapping and flux density at each component is done using Visimag 3:18. The results are shown in Figs. 12 and 13 below.

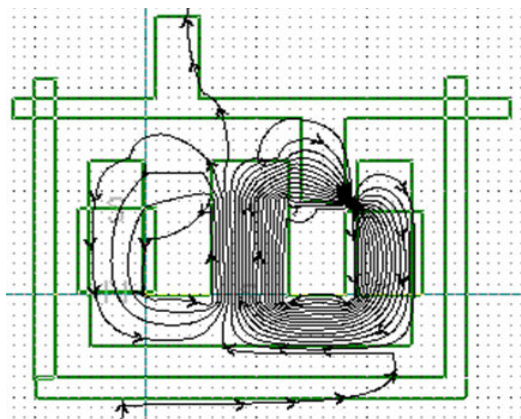

Fig. 12 The mapping of magnetic flux

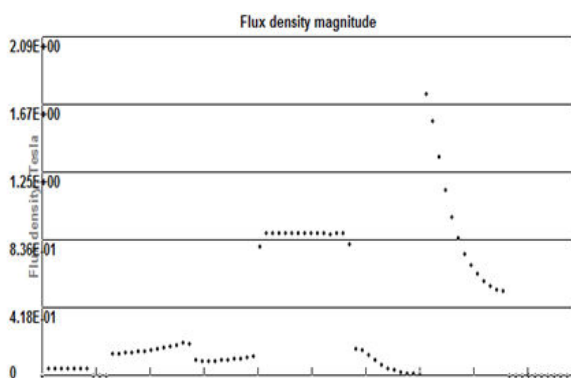

Fig. 13 Flux density field at each component

F. Testing Plan

Shunt DC motor is used in testing of this generator as a motor drive. There are two types of tests performed, namely;

1. No-load test, intended to look at the characteristics of the voltage as a function of rotational speed of the generator.
2. Load testing, intended to get the effect of the load curve of the generator output voltage. Input-output power measurements were also performed on this test.

G. Calculation Method of Input-Output Power

The power flow scheme of these experiments is shown in Fig. 18. The generator shaft input power with no load (P_{inG0}) can be determined by calculating the difference between the motor input power after coupled with generator (P_{inM-G0}) and the motor input power before coupled to a generator (P_{inM0}) reduced by Cu losses due to the motor load, or equations can be written as below:

$$P_{inG0} = P_{inM-G0} - (P_{inM0} + I_a^2 R_a) \quad (15)$$

where: P_{inG0} = No load generator shaft input power (W)

- P_{inM0} = No load motor input power (W)
- P_{inM-G0} = Motor input power after coupled with generator at no load (145 W)
- I_a = Motor armature current (A)
- R_a = Motor armature resistance (13 Ohm)

Generator shaft input power under loaded can be defined by equation below:

$$P_{inGx} = P_{inMx} - (P_{inG0} + (I_{ax})^2 R_a) \quad (16)$$

- where: P_{inGx} = Generator shaft input power of x loaded (W)
- P_{inMx} = Motor input power at x loaded (W)
- P_{inG0} = Generator input power at no load
- I_{AX} = Motor armature current at loaded (A)
- R_a = Armature resistance (13 Ohm)

Power is converted into electrical energy by generator can be determined as equation below:

$$P_{ConGx} = P_{outGx} - (I_{gx})^2 R_g \quad (17)$$

- where: P_{ConGx} = Converted power by generator (W)
- P_{outGx} = Output power of generator on x loaded (W)
- I_{gx} = Generator armature current at x loaded (A)
- R_g = Generator armature resistance (37 Ohm)

Conversion efficiency (η_C) of generator to shaft input power can be calculated by comparing the output power with the shaft input power on the generator, is calculated by equation below:

$$\eta_C = \frac{P_{ConGx}}{P_{inGx}} \quad (18)$$

IV. RESULTS AND DISCUSSION

A. The Design Results

The generators that has been made shown in Fig. 14 below:

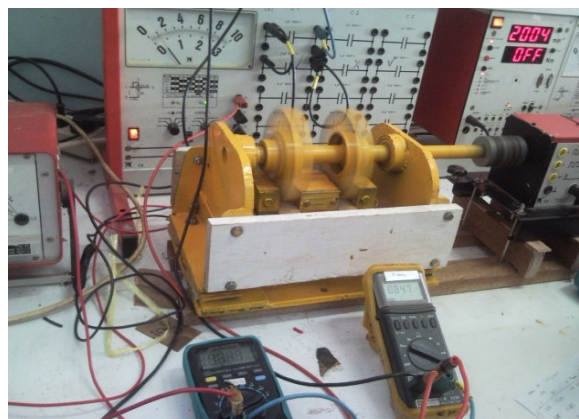

Fig. 14 Permanent magnet reluctance generator prototype new designs trials

B. Generator Testing

1. Generator Testing at No Load

Before testing the generator with no load, the motor power is measured first at the conditions before and after coupled to the generator. The results are shown in Table I below:

TABLE I
POWER MOTOR AT NO LOAD

Condition	I (Amp)	P (Watt)
Before coupled with a generator	0.47	91
After coupled with a generator	0.71	145

No-load voltage measurement is done by vary of generator rotation. The data obtained show that, the increased of generator rotation speed make voltage generated also increased. Complete test results on graph are shown in Fig. 15 below.

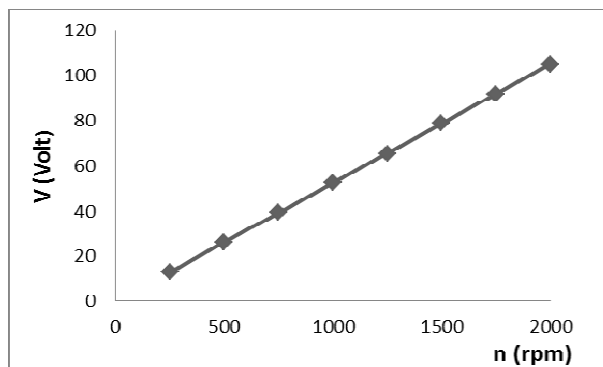

Fig. 15 Characteristics of the output voltage to the rotation speed

2. Generator Testing Under Load

Testing under load carried by the generator operates a constant speed 2000 rpm, and given a variable load resistance. The test result data are shown in Table II below:

TABLE II
LOAD TEST RESULTS

No	Motor			Generator			Load R (Ohm)
	I (Amp.)	V (Volt)	P (Watt)	I (Amp.)	V (Volt)	P _{out} (W)	
1	0.703	205	150	0.12	105.8	11	868
2	0.712	205	149	0.14	105.0	14	683
3	0.722	205	151	0.19	104.8	19	483
4	0.731	205	154	0.27	104.4	28	303.6
5	0.738	205	154	0.48	104.2	49	148.7
6	0.73	206	154	0.69	103.5	56	89.9
7	0.713	206	140	0.80	95.0	59	57.3
8	0.707	205	149	0.85	83.0	58	42.1
9	0.7	205	147	0.90	75.0	53	33.3
10	0.697	206	147	0.94	67.0	49	31.8

TABLE III
POWER INPUT - OUTPUT GENERATOR

No.	Motor			Generator						
	I (Amp.)	V (Volt)	P (Watt)	I (Amp.)	V (Volt)	P _{out} (W)	P _{ConGx} (W)	P _{inGx} (W)	Efficiency (%)	
1	0.703	205	150	0.12	105.8	11	11.53	52.58	22	
2	0.712	205	149	0.14	105.0	14	14.73	51.41	29	
3	0.722	205	151	0.19	104.8	19	20.34	53.22	38	
4	0.731	205	154	0.27	104.4	28	30.70	56.05	55	
5	0.738	205	154	0.48	104.2	49	57.52	55.92	103	
6	0.73	206	154	0.69	103.5	56	73.62	56.07	131	
7	0.713	206	140	0.80	95.0	59	82.68	52.39	158	
8	0.707	205	149	0.85	83.0	58	84.73	51.50	165	
9	0.7	205	147	0.90	75.0	53	82.97	49.63	167	
10	0.697	206	147	0.94	67.0	49	81.69	49.68	164	

The effects of loaded to output voltage graphics are shown in Fig. 16. The output voltage at the load condition is decreased with increasing given load.

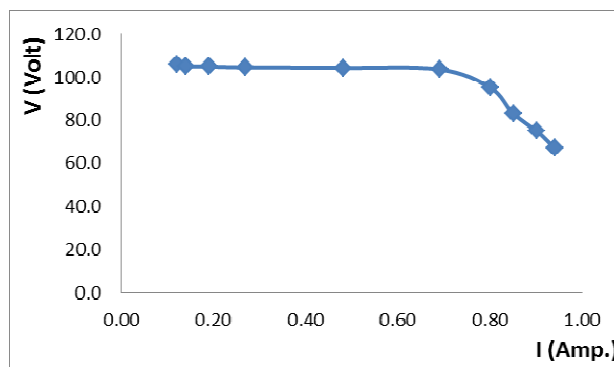

Fig. 16 Characteristics output voltage on load conditions

3. Input Output Power Analysis

Motor input power, before being connected to the generator (no load motor) on the nominal rotation 2000 rpm, measured:

$$P_{inM0} = 91 \text{ Watt}$$

After the coupled to a permanent magnet generator with no load and operated at nominal rotation (2000 rpm), the motor power input is measured by:

$$P_{inM-G0} = 145 \text{ Watt.}$$

Shaft input power generator with no load (P_{inG0}) or no load loses is obtained by the use of (15);

$$P_{inG0} = P_{inM-G0} - (P_{inM0} + I_a^2 R_a)$$

$$P_{inG0} = 145 - 91 - [(0.71)^2 \times 13] = 47.45 \text{ Watt}$$

Generator shaft input power under loaded (P_{inGx}) is calculated by (16) and converted power generator (P_{ConGx}) is calculated by (17). According the data in Table II, can be calculated P_{inGx} , P_{ConG} and conversion efficiency of generator, the results are shown in Table III below:

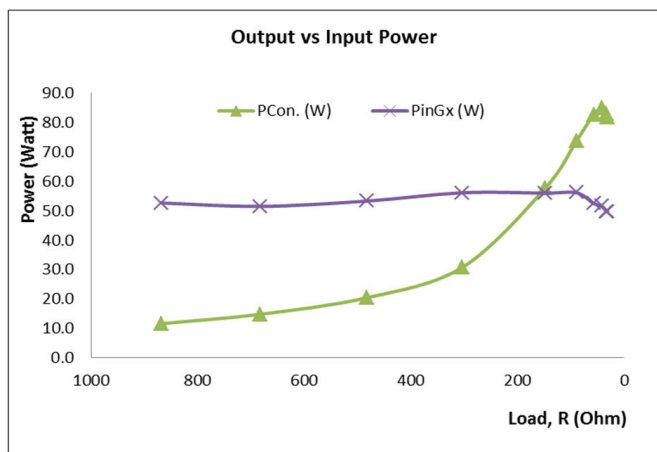

Fig. 17 Graphic shaft input power and output power of the generator

In Fig. 17, it is seen that the generator shaft power input is relatively constant at various load levels. This result is caused by using two rotors with intersecting rotors mounted. When the generator is operated, the electromagnetic torque of the two rotors will always be opposite (destructively) at any time. The impact of the rotor design is the generator shaft power input will tend to be constant despite increased load.

The comparison between power output and the power input of generator shaft, as shown in the input-output curve in Fig. 17 and Table III, there has been a condition where the generator output power is greater than the power input shaft up to 167%.

With the application of the law of conservation of energy in the generator, it can be assured that the energy source of the generator is not entirely derived from the input shaft. If we note the reluctance generator working principle of this new model, the velocity of the rotor actually serves only to divert the direction of magnetic flux flow from the permanent magnet to the right and left foot of the stator core, alternately. Diversion of flux flow direction leads to changes in the magnetic flux in the core of both the stator armature windings so that induced voltage.

By considering the process of transformer energy conversion, electrical energy is initially converted into energy in the form of a magnetic field on the primary side, and then the magnetic field energy is converted back into electrical energy on the secondary side. Energy conversion systems with a magnetic field media are possible only if the magnetic field changes with time. On the transformer, the electrical source changes with time so that the magnetic field generated also changes with time. Magnetic field changes with time are passed to the secondary coil, and the secondary coil magnetic field energy is converted back into electrical energy [4]-[7].

On the permanent magnet reluctance generator of this new model, a constant magnetic field of the permanent magnet is converted into a magnetic field that varies with time by the rotation of the rotor. The magnetic field flows to the right and left foot of the stator core, alternately. The output coil is placed on the right and left leg of the stator, feeling the time-varying fields, so that in the coil, the magnetic field energy is converted into electrical

energy.

When the permanent magnet reluctance generator new model is loaded, it will generate a magnetic field of the output coil. The magnetic field will oppose the magnetic field of the permanent magnet, so that if the continuous load plus the magnetic field in the core is reduced, consequently the converted energy will also be reduced, with its own generator output will drop. This is consistent with the experimental results as shown in the input-output curve in Fig. 17.

Scheme on the power flow when it reaches 167% conversion efficiency is shown in Fig. 18 below. On the scheme, it shows that 83 W of power that is converted into electrical energy, 80.9 W (98%) comes from the permanent magnet.

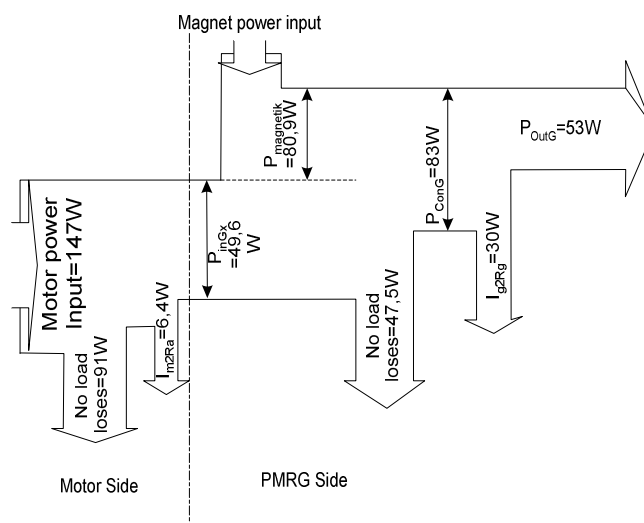

Fig. 18 Power flow scheme

V. CONCLUSION

1. Permanent magnet reluctance generator new model has been developed. The reluctance generator was able to convert energy from permanent magnets into electrical energy.
2. The permanent magnet reluctance generator new models were able to produce power 167%, compared to the shaft input power.
3. The permanent magnet reluctance generator new models only serve as a regulator of the flow of magnetic flux from the source in the form of permanent magnetic field to one to two feet alternately stator core.

ACKNOWLEDGMENT

The author gratefully acknowledges the assistance rendered by the Faculty of Engineering, Andalas University for partially funding this research in DIPA FT Unand 2013 (Contract No.034/PL/SPK/PNP/FT Unand/2013).

REFERENCES

- [1] V. Roschin and S. Godin, *New Energy Technologies*, Faraday Lab Ltd, Russia, 2005

- [2] Pawawoi, A. 2010. Generator reluctance model baru, Polirekayasa Vol. 6 No. 1. Padang.
- [3] Tsukerman, D. Rabinovici, R. New Power Factor and Current Harmonic Mitigation for AC Variable Reluctance Generator with DC Excitation. Israel. Department of Electrical and Computer Engineering. University of The Negev.
- [4] Ichinokura, O., Ono, T., Takahashi, A., Nakamura, K., and Watanabe, T. 2006. Three Phase Reluctance Generator with Permanent Magnet Buried in Stator Core. Japan. Universities Tohoku.
- [5] Peter Campbell, "Permanent Magnet Materials and Their Application", New York: Cambridge University Press, 1994
- [6] Matsch.L, W. Electromagnetic and Electromechanical Machines. Third Ed. John Wiley & Son. Inc. 1987.
- [7] I, J, Nagrath. 1989. Electric Machines. Tata McGraw Hill. New Delhi.