

Power System Stability Improvement by Simultaneous Tuning of PSS and SVC based Damping Controllers Employing Differential Evolution Algorithm

Sangram Keshori Mohapatra, Sidhartha Panda, Prasant Kumar Satpathy

Abstract—Power-system stability improvement by simultaneous tuning of power system stabilizer (PSS) and a Static Var Compensator (SVC) based damping controller is thoroughly investigated in this paper. Both local and remote signals with associated time delays are considered in the present study. The design problem of the proposed controller is formulated as an optimization problem, and differential evolution (DE) algorithm is employed to search for the optimal controller parameters. The performances of the proposed controllers are evaluated under different disturbances for both single-machine infinite bus power system and multi-machine power system. The performance of the proposed controllers with variations in the signal transmission delays has also been investigated. The proposed stabilizers are tested on a weakly connected power system subjected to different disturbances. Nonlinear simulation results are presented to show the effectiveness and robustness of the proposed control schemes over a wide range of loading conditions and disturbances. Further, the proposed design approach is found to be robust and improves stability effectively even under small disturbance conditions.

Keywords—Differential Evolution Algorithm, Power System Stability, Power System Stabilizer, Static Var Compensator.

I. INTRODUCTION

LOW frequency oscillations are observed when large power systems are interconnected by relatively weak tie lines. These oscillations may sustain and grow to cause system separation if no adequate damping is available [1]. Power System Stabilizers [PSS] are now routinely used in the industry to damp out power system oscillations [2]–[4]. However, during some operating conditions, this device may not produce adequate damping, and other effective alternatives are needed in addition to PSS. With the advent of Flexible AC Transmission System (FACTS) technology, shunt FACTS devices play an important role in controlling the reactive power flow in the power network and hence the system voltage fluctuations and stability [5]–[7]. Static Var

Compensator (SVC) is member of FACTS family that is connected in shunt with the system [8]–[9]. Even though the primary purpose of SVC is to support bus voltage by injecting (or absorbing) reactive power; it is also capable of improving the power system stability [10]. When a SVC is present in a power system to support the bus voltage, a supplementary damping controller could be designed to modulate the SVC bus voltage in order to improve damping of system oscillations [11]–[12]. The interaction among PSS and SVC-based controller may enhance or degrade the damping of certain modes of rotor's oscillating.

II. SYSTEM MODEL

A. Single-Machine Infinite-Bus Power System with SVC

To design and optimize the SVC-based damping controller, a single-machine infinite-bus system with SVC, shown in Fig. 1, is considered at the first instance. The system comprises a synchronous generator connected to an infinite-bus through a step-up transformer and a SVC followed by a double circuit transmission line. The generator is equipped with hydraulic turbine & governor (HTG) and excitation system. The HTG represents a nonlinear hydraulic turbine model, a PID governor system, and a servomotor. The excitation system consists of a voltage regulator and DC exciter, without the exciter's saturation function [13]. In Fig. 1, T/F represents the transformer; V_T and V_B are the generator terminal and infinite-bus voltages respectively. All the relevant parameters are given in Appendix. SVC is basically a shunt connected Static Var Generator whose output is adjusted to exchange capacitive or inductive current so as to maintain or control specific power system variables.

B. Overview of SVC and Its Control System

SVC is basically a shunt connected Static Var Generator whose output is adjusted to exchange capacitive or inductive current so as to maintain or control specific power system variables. Fig. 2 shows the single-line diagram of a SVC and a simplified block diagram of its control system. The control system consists of [13]:

- A measurement system measuring the positive-sequence voltage to be controlled.
- A voltage regulator that uses the voltage error (difference between the measured voltage V_m and the reference

S. K. Mohapatra is working as Asst. Professor in the Department of Electrical Engineering, C. V. Raman College of Engineering, Bhubaneswar, Odisha, India (e-mail: sangram_muna@rediffmail.com).

S. Panda is working as Professor in the Department of Electrical & Electronics Engineering, VSSUT, Burla, Odisha, India (e-mail: panda_sidhartha@rediffmail.com).

P. K. Satpathy is working as Professor in the Department of Electrical Engineering, CET, Bhubaneswar, Odisha, India (e-mail: satpathy.pks@gmail.com).

voltage (V_{ref}) to determine the SVC susceptance needed to keep the system voltage constant.

- A distribution unit that determines the Thyristor Switched Capacitors (TSC) and eventually Thyristor Switched Reactors (TSR) that must be switched in and out, and computes the firing angle α of TCRs.

A synchronizing system using a phase-locked loop (PLL) synchronized on the secondary voltages and a pulse generator that send appropriate pulses to the thyristors.

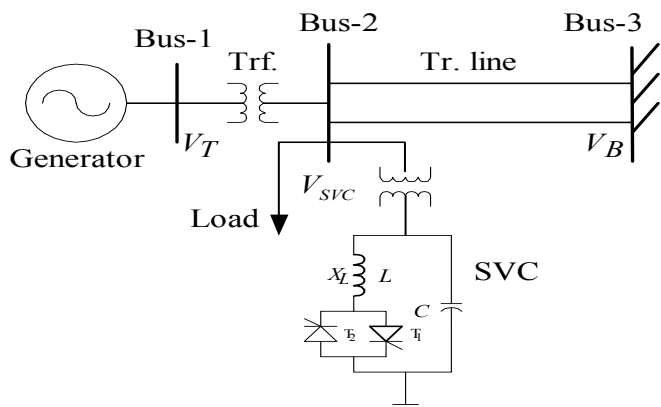

Fig. 1 Single-machine infinite-bus power system with SVC

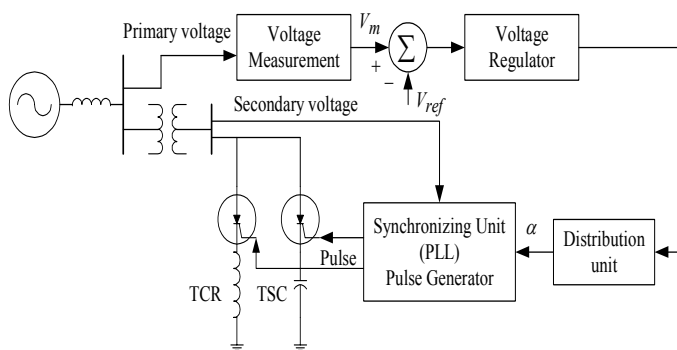

Fig. 2 Single-line diagram of a Static Var Compensator and its control system

III. THE PROPOSED APPROACH

A. Structure of PSS and SVC-Based Damping Controller

The commonly used lead-lag structure shown in Fig. 3 is chosen in this study as a SVC-based damping controller. Fig. 4 shows the structure of the power system stabilizer used in the present study. The structure of SVC controller consists of a delay block, a gain block with gain K_S , a signal washout block and two-stage phase compensation block. The time delay introduced due to delay block depends on the type of input signal. For local input signals only the sensor time constants is considered and for remote signals both sensor time constant and the signal transmission delays are included. The signal washout block serves as a high-pass filter, with the time constant T_W , high enough to allow signals associated with oscillations in input signal to pass unchanged. From the viewpoint of the washout function, the value of is not critical

and may be in the range of 1 to 20 seconds [1]. The phase compensation blocks (time constants T_{1S} , T_{2S} and T_{3S} , T_{4S}) provide the appropriate phase-lead characteristics to compensate for the phase lag between input and the output signals. In Fig. 3, V_{ref} represents the reference voltage as desired by the steady operation of the system. The steady state loop acts quite slowly in practice and hence, in the present study V_{ref} is assumed to be constant during the disturbance period. The desired value of reference voltage is obtained according to the change in the SVC reference ΔV_{SVC} which is added to V_{ref} to get the desired voltage reference V_{SVC_ref} . The structure of power system stabilizer consists of a gain block with gain K_{PS} , a signal Washout Block and two stage phase-compensation blocks which function is same as SVC-based damping controller. The phase compensation blocks (time constants T_{1P} , T_{2P} and T_{3P} , T_{4P}) provide the appropriate phase-lead characteristics to compensate for the phase lag between input and the output signals.

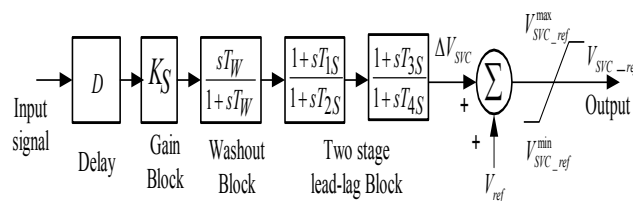

Fig. 3 Structure of proposed SVC-based damping controller

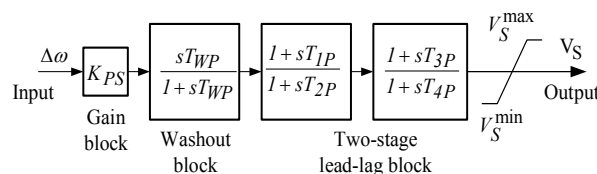

Fig. 4 Structure of the power system stabilizer

B. Problem Formulation

In the lead-lag structured controllers, the washout time constants are usually pre-specified [1]. A washout time constant $T_W = T_{WP} = 10s$ is used in the present study. The controller gain K_S and K_{PS} and the time constants T_{1S} , T_{2S} , T_{3S} , T_{4S} and T_{1P} , T_{2P} , T_{3P} and T_{4P} are to be determined. It is worth mentioning that the proposed controllers are designed to minimize the power system oscillations after a large disturbance so as to improve the power system stability.

In the present study, an integral time absolute error of the speed deviations is taken as the objective function J expressed as:

$$J = \int_{t=0}^{t=t_{sim}} |\Delta\omega| \cdot t \cdot dt \quad (1)$$

where, $\Delta\omega$ is the speed deviation in and t_{sim} is the time range of the simulation.

For objective function calculation, the time-domain simulation of the power system model is carried out for the

simulation period. It is aimed to minimize this objective function in order to improve the system response in terms of the settling time and overshoots. The problem constraints are the SVC controller parameter bounds. Therefore, the design problem can be formulated as the following optimization problem.

Subject to Minimize J (2)

$$\begin{aligned}
 &K_S^{\min} \leq K_S \leq K_S^{\max}; \quad T_{1S}^{\min} \leq T_{1S} \leq T_{1S}^{\max}; \\
 &T_{2S}^{\min} \leq T_{2S} \leq T_{2S}^{\max}; \quad T_{3S}^{\min} \leq T_{3S} \leq T_{3S}^{\max}; \\
 &T_{4S}^{\min} \leq T_{4S} \leq T_{4S}^{\max}; \quad K_{PS}^{\min} \leq K_{PS} \leq K_{PS}^{\max}; \\
 &T_{1P}^{\min} \leq T_{1P} \leq T_{1P}^{\max}; \quad T_{2P}^{\min} \leq T_{2P} \leq T_{2P}^{\max}; \\
 &T_{3P}^{\min} \leq T_{3P} \leq T_{3P}^{\max}; \quad T_{4P}^{\min} \leq T_{4P} \leq T_{4P}^{\max}
 \end{aligned} \quad (3)$$

where K^{\min} and K^{\max} are the lower and upper bounds of the controllers (SVC and PSS) and T^{\min} and T^{\max} are the lower and upper bounds of the time constants of the controllers.

IV. OVERVIEW OF DIFFERENTIAL EVOLUTION

Differential Evolution (DE) algorithm is a stochastic, population-based optimization algorithm recently introduced [14]. DE works with two populations; old generation and new generation of the same population. The size of the population is adjusted by the parameter N_p . The population consists of real valued vectors with dimension D that equals the number of design parameters/control variables. The population is randomly initialized within the initial parameter bounds. The optimization process is conducted by means of three main operations: mutation, crossover and selection. In each generation, individuals of the current population become target vectors. For each target vector, the mutation operation produces a mutant vector, by adding the weighted difference between two randomly chosen vectors to a third vector. The crossover operation generates a new vector, called trial vector, by mixing the parameters of the mutant vector with those of the target vector. If the trial vector obtains a better fitness value than the target vector, then the trial vector replaces the target vector in the next generation. The evolutionary operators are described below [15]–[17].

A. Initialization

For each parameter j with lower bound X_j^L and upper bound X_j^U , initial parameter values are usually randomly selected uniformly in the interval $[X_j^L, X_j^U]$.

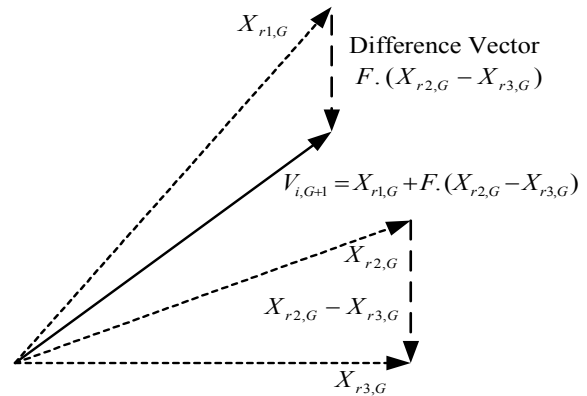

Fig. 5 Vector addition and subtraction in DE to generate a new candidate solution

B. Mutation

For a given parameter vector $X_{i,G}$, three vectors ($X_{r1,G}$, $X_{r2,G}$, $X_{r3,G}$) are randomly selected such that the indices i , $r1$, $r2$ and $r3$ are distinct. A donor vector $V_{i,G+1}$ is created by adding the weighted difference between the two vectors to the third vector as:

$$V_{i,G+1} = X_{r1,G} + F \cdot (X_{r2,G} - X_{r3,G}) \quad (4)$$

where F is a constant from (0, 2)

C. Crossover

Three parents are selected for crossover and the child is a perturbation of one of them. The trial vector $U_{i,G+1}$ is developed from the elements of the target vector (Y) and the elements of the donor vector ($X_{i,G}$). Elements of the donor vector enter the trial vector with probability CR as:

$$U_{j,i,G+1} = \begin{cases} V_{j,i,G+1} & \text{if } rand_{j,i} \leq CR \text{ or } j = I_{rand} \\ X_{j,i,G+1} & \text{if } rand_{j,i} > CR \text{ or } j \neq I_{rand} \end{cases} \quad (5)$$

With $rand_{j,i} \sim U(0,1)$, I_{rand} is a random integer from $(1,2,\dots,D)$ where D is the solution's dimension i.e number of control variables. I_{rand} ensures that $V_{i,G+1} \neq X_{i,G}$.

D. Selection

The target vector $X_{i,G}$ is compared with the trial vector $V_{i,G+1}$ and the one with the better fitness value is admitted to the next generation. The selection operation in DE can be represented by the following equation:

$$X_{i,G+1} = \begin{cases} U_{i,G+1} & \text{if } f(U_{i,G+1}) < f(X_{i,G}) \\ X_{i,G} & \text{otherwise.} \end{cases} \quad (6)$$

where $i \in [1, N_p]$.

Fig. 5 shows the vector addition and subtraction necessary to generate a new candidate solution. The flow chart of proposed DE algorithm to optimally tune the controller parameters is shown in Fig. 6.

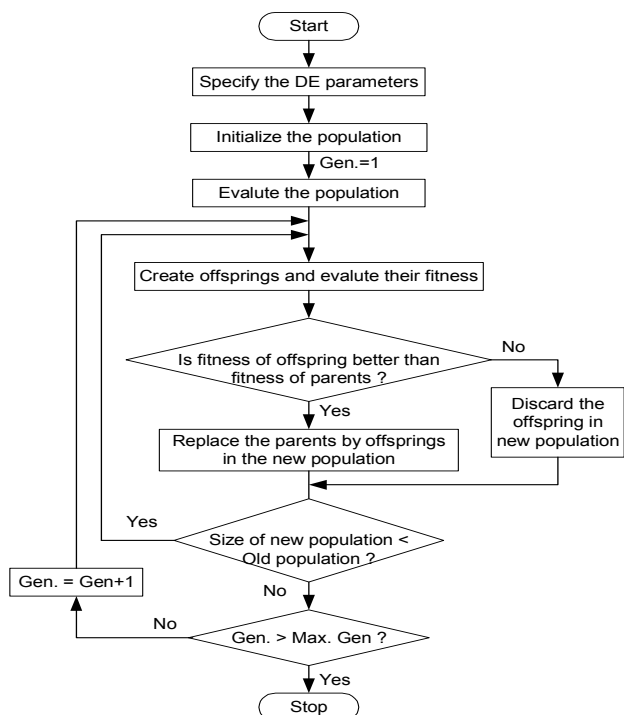

Fig. 6 Flow chart of proposed DE optimization approach

V. RESULTS AND DISCUSSIONS

The behavior underlying the performance of a synchronous machine with the excitation system, mechanical control system, and installed FACTS controller etc., is represented by a set of non-linear differential equations. Thus the complete mathematical description of a power system becomes difficult to solve. To simplify the computational burden, linearized models are used which gives satisfactory results under small disturbance conditions. However, linear models cannot properly capture complex dynamics of the system, especially during major disturbances. This presents difficulties for tuning the FACTS controllers in that, the controllers tuned to provide desired performance at small disturbance condition do not guarantee acceptable performance in the event of major disturbances. The complete non-linear model of the power system with FACTS can be developed in MATLAB/SIMULINK using the inbuilt non-linear power system components or by developing the non-linear models of some power system components. The SimPowerSystems (SPS) toolbox is used for all simulations and SVC-based damping controller design [13]. SPS is a MATLAB-based modern design tool that allows scientists and engineers to rapidly and easily build models to simulate power systems using Simulink environment. In order to optimally tune the parameters of the SVC-based damping controller, as well as to assess its performance, the model of example power system

shown in Fig. 2 is developed using SPS blockset. (Please refer to Appendix for relevant parameters).

A .Application of DE

The model of the system under study has been developed using SimPowerSystem Toolbox in MATLAB/SIMULINK environment. For objective function calculation; the developed model is simulated in a separate program (by .m file using initial population/controller parameters) considering a severe disturbance. From the SIMULINK model the objective function value is evaluated and moved to workspace. The process is repeated for each individual in the population. For objective function calculation, a 3-phase short-circuit fault in one of the parallel transmission lines is considered. Using the objective function values, the population is modified by DE for the next generation. For the purpose of optimization of (3), DE is employed. Using each set of controllers' parameters, the time-domain simulation is performed and the fitness value is determined. The objective function is evaluated for each individual by simulating the example power system, considering a severe disturbance. For objective function calculation, a 3-phase short-circuit fault in one of the parallel transmission lines is considered.

Implementation of DE requires the determination of six fundamental issues: DE step size function, crossover probability, the number of population, initialization, termination and evaluation function. Generally DE step size (F) varies in the interval (0, 2). A good initial guess to F is in the interval (0.5, 1). Crossover probability (CR) constants are generally chosen from the interval (0.5, 1). If the parameter is co-related, then high value of CR work better, the reverse is true for no correlation [15]–[17]. In the present study, a population size of $N_p=20$, generation number $G=200$, step size $F=0.8$ and crossover probability of $CR=0.8$ have been used. Optimization is terminated by the prespecified number of generations for DE. One more important factor that affects the optimal solution more or less is the range for unknowns. For the very first execution of the program, a wider solution space can be given and after getting the solution one can shorten the solution space nearer to the values obtained in the previous iteration. The flow chart of the DE algorithm employed in the present study is given in Fig. 6. Simulations were conducted on a Pentium 4, 3 GHz, 504 MB RAM computer, in the MATLAB 7.8.0 environment. The optimization was repeated 20 times and the best final solution among the 20 runs is chosen as proposed controller parameters. The best final solutions obtained in the 20 runs are given in Table I for two cases i.e. Case-1: ΔP_L -based SVC (Local signal) coordinated with $\Delta\omega$ -based PSS and Case-2: $\Delta\omega$ -based SVC (Remote signal with delay) coordinated with $\Delta\omega$ -based PSS.

TABLE I
CONTROLLER PARAMETERS FOR SMIB POWER SYSTEM

| Signal/parameters | K_S/K_{PS} | T_{1S}/T_{1P} | T_{2S}/T_{2P} | T_{3S}/T_{3P} | T_{4S}/T_{4P} |
|---------------------------|--------------|-----------------|-----------------|-----------------|-----------------|
| $\Delta\omega$ -based SVC | 12.3941 | 1.2264 | 2.1326 | 2.1849 | 0.6765 |
| $\Delta\omega$ -based PSS | 10.4239 | 1.4129 | 1.6011 | 1.0432 | 0.5157 |
| ΔP_L based SVC | 47.1573 | 1.3579 | 0.1502 | 1.6454 | 2.2242 |
| $\Delta\omega$ -based PSS | 5.4825 | 1.0950 | 0.7013 | 2.4631 | 1.5223 |

TABLE II
LOADING CONDITIONS CONSIDERED

| Loading conditions | P_e in per unit (pu) | δ_0 in Degree |
|--------------------|------------------------|----------------------|
| Nominal | 0.85 | 51.51 ⁰ |
| Light | 0.5 | 29.33 ⁰ |
| Heavy | 1 | 60.73 ⁰ |

B Simulation Results

During normal operating condition there is complete balance between input mechanical power and output electrical power and this is true for all operating points. During disturbance, the balance is disturbed and the difference power enters into/drawn from the rotor. Hence the rotor speed deviation and subsequently all other parameters (power, current, voltage etc.) change. As the input to the SVC controller is the speed deviation/electrical power, the SVC reference voltage is suitable modulated and the power balanced is maintained at the earliest time period irrespective of the operating point. So, with the change in operating point also the SVC controller parameters remain fixed. To assess the effectiveness and robustness of the proposed controller, three different operating conditions as given in Table II are considered. The following cases are considered:

1. Case-A: Nominal Loading, 3-Phase Fault Cleared by Line Outage

The behavior of the proposed controller is verified at nominal loading condition under severe disturbance condition. A 5 cycle, 3-phase fault is applied at the middle of one transmission line connecting bus 2 and bus 3, at $t = 1.0$ s. the fault is removed by opening the faulty line and the lines are reclosed after 5 cycles. The system response under this severe disturbance is shown in Figs. 7-9 where, the response without control (no control) is shown with dotted line with legend 'No Control'; the response with proposed DE optimized ΔP_L -based SVC (local signal) and $\Delta\omega$ -based PSS is shown with dashed line with legend 'Local signal' and the response with proposed DE optimized $\Delta\omega$ -based SVC (Remote signal with delay) and $\Delta\omega$ -based PSS is shown with solid line with legend 'Remote signal'. It can be seen from Figs. 7-9 that without control the system is highly oscillatory under the above contingency. It is also clear from Figs. 7-9 that the response with $\Delta\omega$ -based SVC (Remote signal with delay) coordinated with $\Delta\omega$ -based PSS is better than ΔP_L -based SVC (Local signal) coordinated with $\Delta\omega$ -based PSS. The variation of reference voltage of SVC and the stabilizing signal of PSS for the above contingency is shown in Figs. 10-

11. It is clear from Figs. 10, 11 that the stabilizing signals of both the damping controllers are appropriately modified to damp the low frequency oscillations.

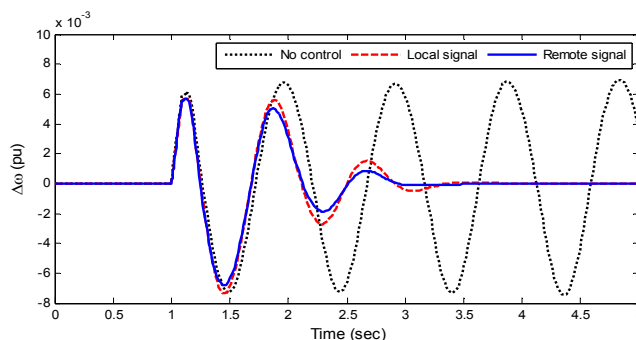

Fig. 7 Speed deviation response for Case-A

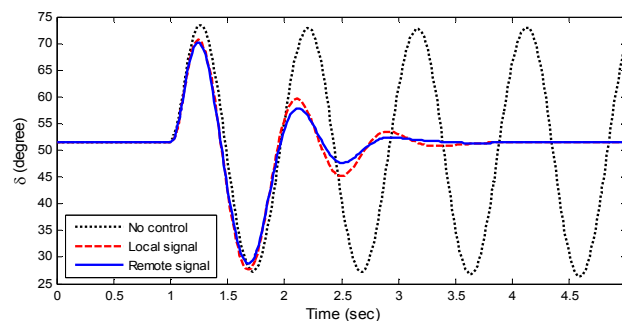

Fig. 8 Rotor angle response for Case-A

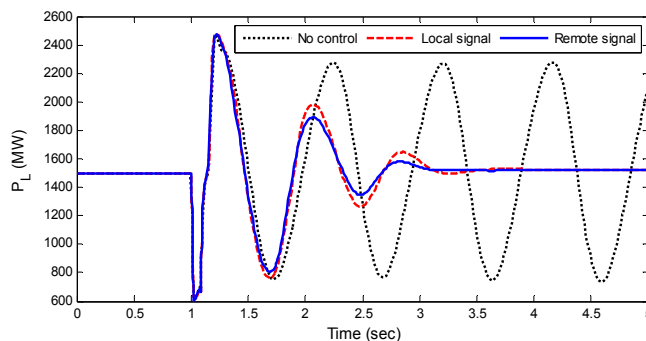

Fig. 9 Tie-line power flow response for Case-A

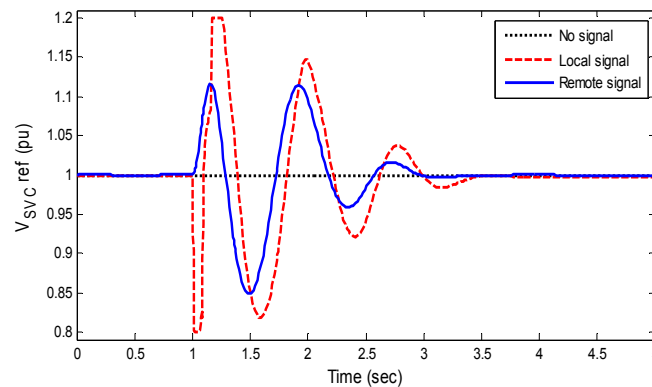

Fig. 10 Variation of SVC reference voltage for Case-A

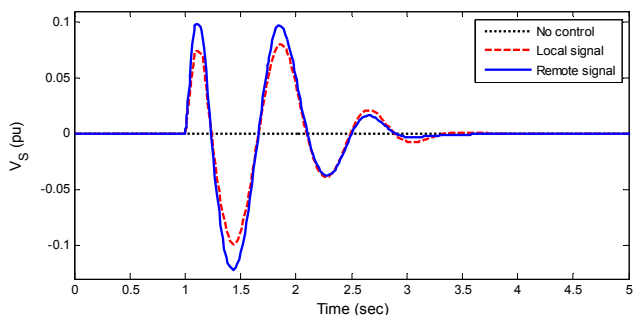

Fig. 11 Variation of stabilizing signal of PSS for Case-A

2. Case-B: Light Loading, Self Clearing 3-Phase Fault

To test the robustness of the controller to the operating condition and type of disturbance, the generator loading is changed to light loading condition as given in Table II. A 5 cycle self clearing 3-phase fault is assumed near bus 3 at $t=1.0$ s. The system Response under this contingency is shown in Figs. 12-13 which clearly depict the robustness of the proposed controllers for changes in operating condition and fault location. It can be seen From Figs. 12-13 that with the decrease in loading condition, the performance of ΔP_L -based SVC (Local signal) coordinated with $\Delta\omega$ -based PSS is almost similar to that of $\Delta\omega$ -based SVC (Remote signal with delay) coordinated with $\Delta\omega$ -based PSS controllers.

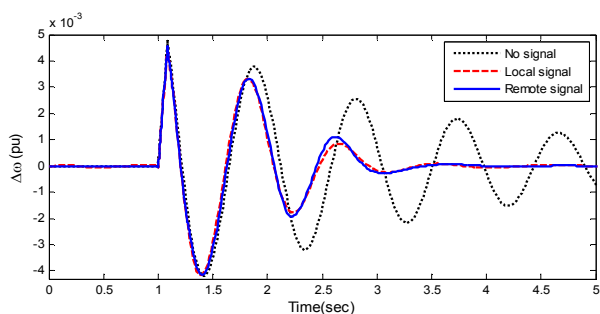

Fig. 12 Speed deviation response for Case-B

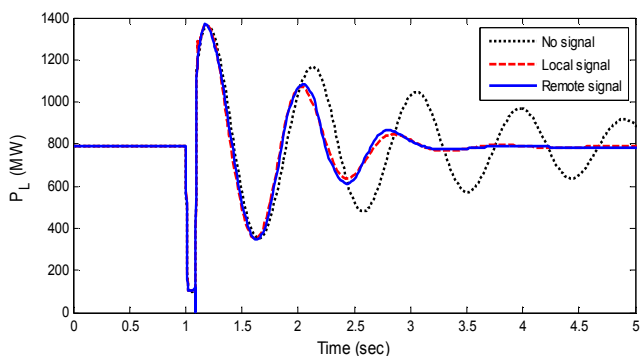

Fig. 13 Tie line power flow response for Case-B

3. Case-C: Heavy Loading, Small Disturbance

The robustness of the proposed controller is also verified at heavy loading condition under small disturbance by disconnecting the load near bus 1 at $t=1.0$ s for 100 ms with

generator loading being changed to heavy loading condition. The system response under this contingency is shown in Figs. 14-15. It is clear from Figs. 14-15 that the system is unstable without control. Stability is maintained and power system oscillations are quickly damped with both the proposed approach and the responses are almost similar with both signals.

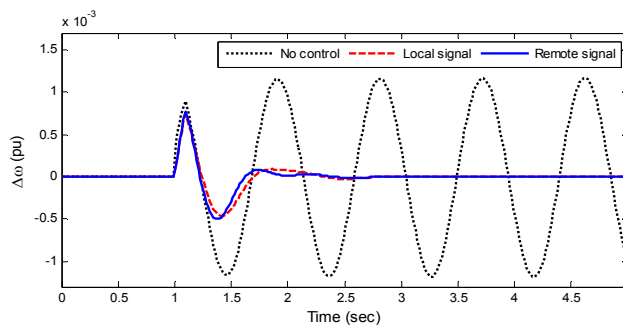

Fig. 14 Speed deviation response for Case-C

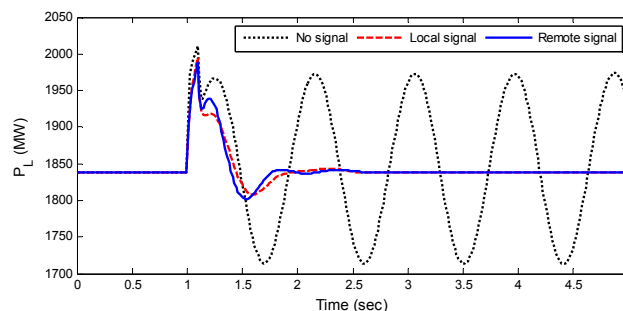

Fig. 15 Tie line power flow response for Case-C

4. Case-D: Effect Of Signal Transmission Delay

To study the effect of variation in signal transmission delay on the performance of controller, the transmission delay is varied and the response is shown in Fig. 16. In this case, nominal loading condition and $\Delta\omega$ -based SVC coordinated with $\Delta\omega$ -based PSS controllers are considered. A 5 cycle, 3-phase, self clearing fault is assumed at the middle of one transmission line for the analysis purpose. It is evident from Fig. 16 that the performances of the proposed controllers are hardly affected by the signal transmission delays.

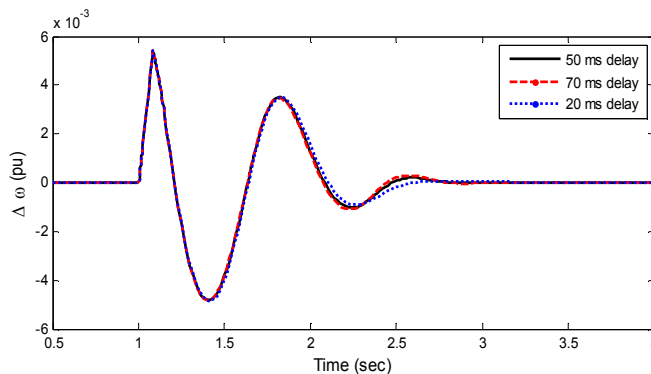

Fig. 16 Speed deviation response for Case-D

C . Extension to Multi-Machine Power System with SVC

The proposed approach of coordinately designing PSS and SVC based damping controllers is further extended to a multi-machine power system shown in Fig. 17. It is similar to the power system used in references [17]–[20]. The system consists of three generators divided in to two subsystems and are connected via an intertie. Following a disturbance, the two subsystems swing against each other resulting in instability. To improve the stability a SVC is assumed on the mid-point of the tie line. The relevant data for the system are given in Appendix. For remote input signal speed deviation of generator G1 and G2 is chosen as the control input of SVC based damping controller and for local signal real power flow at the nearest bus (bus5) is selected.

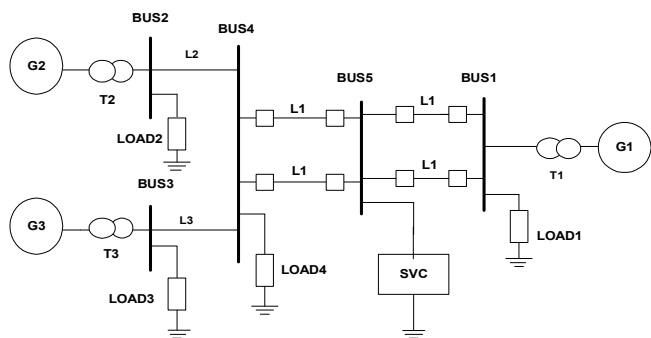

Fig. 17 Three machine power system with SVC

The objective functions J is defined as:

$$J = \int_{t=0}^{t=t_{sim}} (\sum |\Delta\omega_L| + \sum |\Delta\omega_I|) \cdot t \cdot dt \quad (7)$$

where $\Delta\omega_I$ and $\Delta\omega_L$ are the speed deviations of inter-area and local modes of oscillations respectively and t_{sim} is the time range of the simulation. The same approach as explained for SMIB case is followed to optimize the SVC-based damping controller parameters for three-machine case (i.e. for remote signal a delay of 50 ms has been considered and for local signal the delay is neglected). The best among the 20 runs for both the input signals are shown in Table III.

TABLE III
CONTROLLER PARAMETERS FOR MULTI MACHINE POWER SYSTEM

| Signal/ parameters | K_S/K_{PS} | T_{1S}/T_{1P} | T_{2S}/T_{2P} | T_{3S}/T_{3P} | T_{4S}/T_{4P} |
|-----------------------------|--------------|-----------------|-----------------|-----------------|-----------------|
| $\Delta\omega$ -based SVC | 63.8947 | 2.2330 | 0.1527 | 0.4403 | 1.0414 |
| $\Delta\omega$ -based PSS-1 | 36.9899 | 2.2325 | 0.0656 | 0.3448 | 1.0608 |
| $\Delta\omega$ -based PSS-2 | 38.2286 | 1.3116 | 1.8864 | 0.4253 | 1.6821 |
| $\Delta\omega$ -based PSS-3 | 30.9330 | 0.0181 | 1.8508 | 2.4793 | 0.3213 |
| ΔP_L based SVC | 24.8960 | 0.9667 | 1.0792 | 2.0774 | 2.0618 |
| $\Delta\omega$ -based PSS-1 | 22.6505 | 0.9520 | 2.3147 | 1.8524 | 1.8443 |
| $\Delta\omega$ -based PSS-2 | 47.3459 | 1.2757 | 1.9799 | 1.1310 | 2.1231 |
| $\Delta\omega$ -based PSS-3 | 19.5222 | 1.8462 | 2.4411 | 1.3087 | 1.0754 |

A self clearing 3-phase fault is applied near bus 1 at $t = 1$ s. The fault is cleared after 5 cycles and the original system is

restored after the fault clearance. Figs. 18-20 show the system response for both the control inputs. It is clear from Figs. 18-20 that inter-area modes of oscillations are highly oscillatory in the absence of control and the proposed controllers significantly improves the power system stability by damping these oscillations. However, remote signal seems to be a better choice compared to the local signal as the power system oscillations are quickly damped out with local signal.

To show the robustness of the proposed approach, another disturbance is considered. The transmission line between bus 5 and bus 1 is tripped at $t=1.0$ sec and reclosed after 5 cycles. The system response is shown in Figs. 21-22 from which it is clear that remote signal with delay is a better choice than local signal. For completeness, the load at bus 1 is disconnected for 100 ms and the system response is shown in Figs. 23-24. It is clear from these Figs. that the proposed controllers are robust and damps power system oscillations even under small disturbance conditions. Further, the performance with remote speed deviation signal is better than that with local signal.

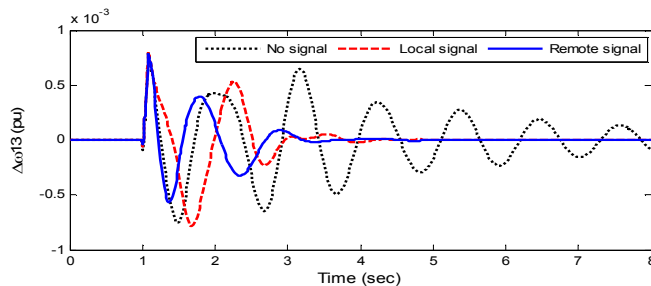

Fig. 18 Inter-area mode of oscillation for self clearing three phase fault disturbance

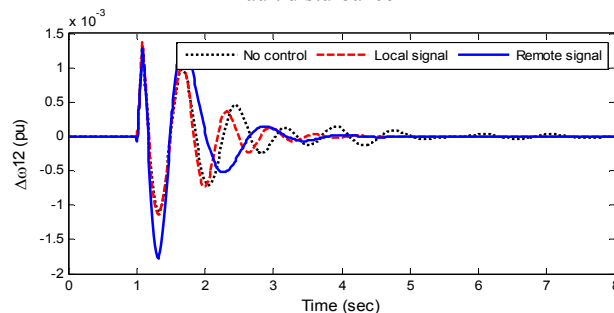

Fig. 19 Local mode of oscillation for self clearing three phase fault disturbance

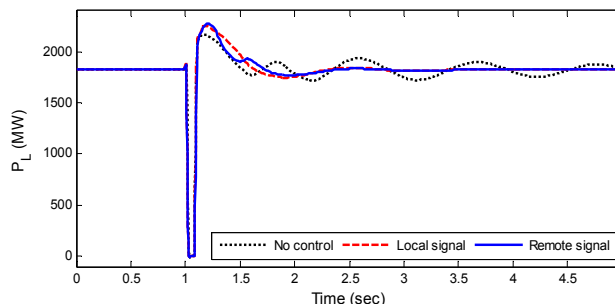

Fig. 20 Tie line power flow for self clearing three phase fault disturbance

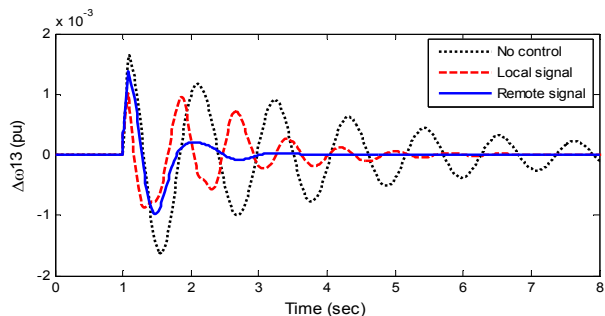

Fig. 21 Inter-area mode of oscillation for line outage disturbance

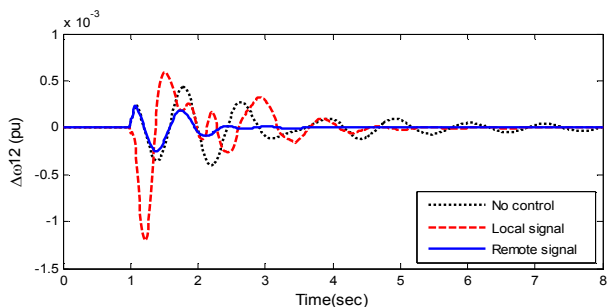

Fig. 22 Local mode of oscillation for line outage disturbance

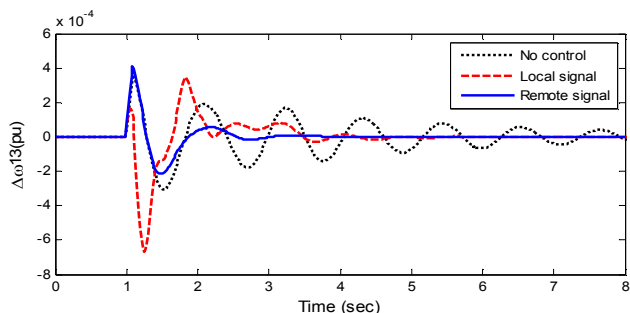

Fig. 23 Inter-area mode of oscillation for small disturbance

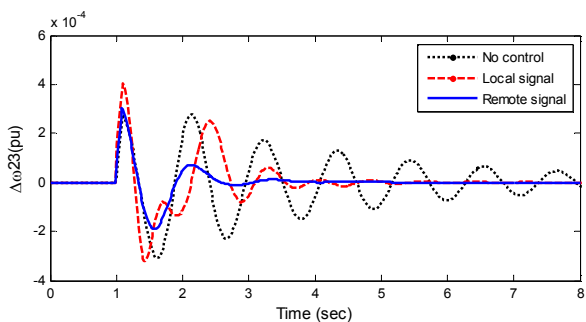

Fig. 24 Local mode of oscillation for small disturbance

VI. CONCLUSION

In this study, power system stability improvement by coordinated design of power system stabilizer (PSS) and a static synchronous var compensator (SVC)-based damping controller is thoroughly investigated. Both local and remote signals are employed for the SVC based controller. Potential time delays due to sensor time constant and signal

transmission delays for remote signals are considered in the design process. The design problem is formulated as an optimization problem, and differential evolution (DE) is employed to search for the optimal controller parameters. The performance of the proposed controller is evaluated under different disturbances for both single-machine infinite bus power system and multi-machine power system using both local and remote signals. It is also observed that from power system stability improvement point of view remote signal is a better choice than the local signal. Additionally, it is observed that the performance of the designed SVC-based controller with remote signal is almost not affected by the variations in the signal transmission delays.

APPENDIX

System data: All data are in pu unless specified otherwise. The variables are as defined in [13].

A. Single-Machine Infinite-Bus Power System

1. Generator

$S_B = 2100$ MVA, $H = 3.7$ s, $V_B = 13.8$ kV, $f = 60$ Hz, $R_S = 2.8544 \times 10^{-3}$, $X_d = 1.305$, $X'_d = 0.296$, $X''_d = 0.252$, $X_q = 0.474$, $X'_q = 0.243$, $X''_q = 0.18$, $T_d = 1.01$ s, $T'_d = 0.053$ s, $T_{q0} = 0.1$ s.

2. Load at Bus2

250MW

3. Transformer

2100 MVA, 13.8/500 kV, 60 Hz, $R_1 = R_2 = 0.002$, $L_1 = 0$, $L_2 = 0.12$, D_l/Y_g connection, $R_m = 500$, $L_m = 500$

4. Transmission Line

3-Ph, 60 Hz, Length = 300 km each, $R_l = 0.02546 \Omega/\text{km}$, $R_0 = 0.3864 \Omega/\text{km}$, $L_l = 0.9337 \times 10^{-3}$ H/km, $L_0 = 4.1264 \times 10^{-3}$ H/km, $C_l = 12.74 \times 10^{-9}$ F/km, $C_0 = 7.751 \times 10^{-9}$ F/km

5. Hydraulic Turbine and Governor

$K_a = 3.33$, $T_a = 0.07$, $G_{min} = 0.01$, $G_{max} = 0.97518$, $V_{gmin} = -0.1$ pu/s, $V_{gmax} = 0.1$ pu/s, $R_p = 0.05$, $K_p = 1.163$, $K_i = 0.105$, $K_d = 0$, $T_d = 0.01$ s, $\beta = 0$, $T_w = 2.67$ s

6. Excitation system

$T_{LP} = 0.02$ s, $K_a = 200$, $T_a = 0.001$ s, $K_e = 1$, $T_e = 0$, $T_b = 0$, $T_c = 0$, $K_f = 0.001$, $T_f = 0.1$ s, $E_{fmin} = 0$, $E_{fmax} = 7$, $K_p = 0$

7. Static Var Compensator

500KV, ± 100 MVAR, Droop=0.03

B. Multi-Machine Power System

1. Generators

$S_{B1} = 4200$ MVA, $S_{B2} = S_{B3} = 2100$ MVA, $V_B = 13.8$ kV, $f = 60$ Hz, $X_d = 1.305$, $X'_d = 0.296$, $X''_d = 0.252$, $X_q = 0.474$, $X'_q = 0.243$, $X''_q = 0.18$, $T_d = 1.01$ s, $T'_d = 0.053$ s, $T''_{q0} = 0.1$ s, $R_S = 2.8544 \times 10^{-3}$, $H = 3.7$ s, $p = 32$

2. Transformers

$S_{B1} = 4200$ MVA, $S_{B2} = S_{B3} = 2100$ MVA, D_1/Y_g , $V_1 = 13.8$ kV, $V_2 = 500$ kV, $R_1 = R_2 = 0.002$, $L_1 = 0$, $L_2 = 0.12$, $R_m = 500$, $L_m = 500$

3. Transmission Lines

3-Ph, $R_1 = 0.02546$ Ω / km, $R_0 = 0.3864$ Ω / km, $L_1 = 0.9337 \times 10^{-3}$ H/km, $L_0 = 4.1264 \times 10^{-3}$ H/ km, $C_1 = 12.74 \times 10^{-9}$ F/ km, $C_0 = 7.751 \times 10^{-9}$ F/ km, $L_1 = 175$ km, $L_2 = 50$ km, $L_3 = 100$ km

4. Loads

Load 1=7500 MW+1500 MVAR, Load 2=Load 3=25 MW, Load 4=250 M

[20] S. Mishra, et al., "Genetically optimized neuro-fuzzy IPFC for damping modal oscillations of power system," *IEEE Trans. Power Syst.*, vol.17, pp. 1140–1147, 2002.

Sangram Keshori Mohapatra received M.Tech Degree from KIIT, University, Orissa, Bhubaneswar, India in 2008. Presently he is working as an Assistant Professor in the Department of Electrical Engineering, C.V.Raman College of Engineering, Bhubaneswar, Odisha, India. He worked in various reputed organizations for 12 years. His research interest is in the area of Power System Stability, FACTS and Optimization techniques.

Dr. Sidhartha Panda is working as a Professor at VSSUT, Burla (erstwhile UCE, Burla). He received Ph.D. degree from IIT, Roorkee and M.E. degree from UCE, Burla in Electrical Engineering. Earlier he worked in various reputed organizations for 18 years. He has published about 65 papers in various International Journals. His areas of research include MATLAB/SIMULINK, Flexible AC Transmission Systems (FACTS), Modeling of Machines, Power Systems and FACTS, Controller Design, Power System Stability, Genetic Algorithm, Particle Swarm Optimization, Differential Evolution, Multi-objective Optimization, Economic Operation of Power System, Fuzzy Logic, Model Order Reduction, Distributed Generation and Wind Energy

Dr.P. K. Satpathy, obtained his Ph.D. Degree from IIT, Kharagpur in 2003 and M.Tech Degree from IIT, Delhi in 1996 (in the area of Electrical Engineering with specialization in Electric Power Systems). Being a graduate in Electrical Engineering from University College of Engineering, Burla (1989), he joined academics in the year 1990 and has acquired more than 20 years of experience in the field of Academics and Research pertaining to Electrical Engineering. Presently he is positioned as Professor and Head in the Department of Electrical Engineering, College of Engineering and Technology, Bhubaneswar, a premier constituent college of BPUT, Orissa. He has several international publications to his credit. Besides an author of two text books, he is a Member/Fellow/Reviewer of various organizations of National and International repute (Elsevier, IE-India, ISTE, Inpowerg, Interscience).

REFERENCES

- [1] P. Kundur, *Power System Stability and Control*. New York: McGraw-Hill, 1994.
- [2] S. Panda, N. P. Padhy, "Robust power system stabilizer design using particle swarm optimization technique," *Int. J. Elect. Syst. Sc. & Engg.* vol.1, pp.1–8, 2008.
- [3] S. Panda, C. Ardil, "Robust coordinated design of multiple power system stabilizers using particle swarm optimization technique," *Int. J. Elect. Syst. Sc. & Engg.*, vol.1, pp. 41–48, 2008.
- [4] S. Panda, C. Ardil, "Real-coded genetic algorithm for robust power system stabilizer design," *Int. J. Elect. Comp. & Syst. Engg.* vol.2, 2008, pp.6–14.
- [5] N. G. Hingorani, L. Gyugyi, *Understanding FACTS: Concepts and Technology of Flexible AC Transmission Systems*, IEEE Press, New York, 2000.
- [6] Y. H Song, T. A. Johns, *Flexible AC Transmission Systems*, IEE, London, 2000.
- [7] R. M Mathur, R. K. Verma, "Thyristor-based FACTS Controllers for Electrical Transmission Systems," *IEEE Press, Piscataway*, 2002.
- [8] L. Gyugyi, "Reactive power generation and control by thyristor circuits," *IEEE Trans. Industrial Applications*, vol-1, pp.521–532, 1979.
- [9] L. Gyugyi, "Power electronics in electric utilities: static var compensators," *IEE Proceedings*, vol.76, pp.483–494, 1988.
- [10] T. Hiyama, W. Hubbi, T. H. Ortmeyer, "Fuzzy logic control scheme with variable gain for static Var compensator to enhance power system stability," *IEEE Trans. Power Syst.*, vol.14, pp.186–191, 1999.
- [11] X. Y. Bian, C. Y. Chunga, K.W. Wang, C.T. Tse, "Choice of SVC location/signal and its controller design by probabilistic method," *Elect. Power Syst. Res.* vol.71, pp. 35–40, 2004.
- [12] Y. Chang, Z. Xu, "A novel SVC supplementary controller based on wide area signals," *Elect. Power Syst. Res.* vol.77, pp.1569–1574, 2008.
- [13] SimPowerSystems4.3User'sGuide. Available from: <http://www.mathworks.com>
- [14] R. Storn, K. Price, "Differential evolution—a simple and efficient adaptive scheme for Global Optimization over continuous spaces," *J. Global Optim.* vol.11, pp.341–359, 1995.
- [15] S. Panda, "Multi-objective evolutionary algorithm for SSSC-based controller design," *Elect. Power Syst. Res.* vol.79, pp. 937–944, 2009.
- [16] S. Panda, "Differential evolutionary algorithm for TCSC-based controller design," *Simulation Modelling Pract. Theory* vol.17, pp.1618–1634.
- [17] S. Panda, "Robust coordinated design of multiple and multi-type damping controller using differential evolution algorithm," *Int. J. Elect. Power & Energy Syst.*, vol.33, pp.1018–1030, 2011.
- [18] S. Panda, "Differential evolution algorithm for SSSC-based damping controller design considering time delay," *J. Franklin Institute*, vol.348, no.8, pp.1903–1926, 2011.
- [19] M. Noroozian, et al., "Robust near-optimal control of power system oscillation with fuzzy logic," *IEEE Trans. Power Deliv.*, vol.11, pp.393–400, 1996.