

Experimental Study on Adsorption Capacity of Activated Carbon Pairs with Different Refrigerants

Ahmed N. Shmroukh, Ahmed Hamza H. Ali, Ali K. Abel-Rahman

Abstract—This study is experimentally targeting to develop effective in heat and mass transfer processes for the adsorbate to obtain applicable adsorption capacity data. This is done by using fin and tube heat exchanger core and the adsorbate is adhesive over its surface and located as the core of the adsorber. The pairs are activated carbon powder/R-134a, activated carbon powder/R-407c, activated carbon powder/R-507A, activated carbon granules/R-507A, activated carbon granules/R-407c and activated carbon granules/R-134a, at different adsorption temperatures of 25, 30, 35 and 50°C. The following results are obtained: at adsorption temperature of 25 °C the maximum adsorption capacity is found to be 0.8352kg/kg for activated carbon powder with R-134a and the minimum adsorption capacity found to be 0.1583kg/kg for activated carbon granules with R-407c. While, at adsorption temperature of 50°C the maximum adsorption capacity is found to be 0.3207kg/kg for activated carbon powder with R-134a and the minimum adsorption capacity found to be 0.0609kg/kg for activated carbon granules with R-407c. Therefore, the activated carbon powder/R-134a pair is highly recommended to be used as adsorption refrigeration working pair because of its higher maximum adsorption capacity than the other tested pairs, to produce a compact, efficient and reliable for long life performance adsorption refrigeration system.

Keywords—Adsorption, Adsorbent/Adsorbate Pairs, Adsorption Capacity, Refrigeration.

I. INTRODUCTION

RECENTLY there is more interest in development of adsorption refrigeration technology. The main arguments in favor are that sorption systems are quiet, long lasting, cheap to maintain and environmentally benign [1]. The adsorption refrigeration working pair is a vital and important component in the adsorption refrigeration system, therefore developments in the adsorption pairs lead to the improvement of the adsorption refrigeration systems performance. Therefore one step toward developing an energy efficient and environmental friendly air conditioning and refrigeration systems, is to utilize the adsorption refrigeration technology. Moreover is to use an effective refrigerant with the solid adsorbent, which has lower impact on the environment with higher adsorption capacity than the available pairs. The adsorption cooling and refrigeration systems have the advantages of being free of moving parts, efficiently driven by low-temperature waste heat or renewable energy sources and do not require any synthetic lubricants [2]. Askalany et al. [3] presented a review

Ahmed N. Shmroukh is a PhD student (ahmed.shmroukh@ejust.edu.eg), Ahmed Hamza H. Ali, is a professor (ahmed.hamza@ejust.edu.eg) of Refrigeration and Air Conditioning and chairperson of the Department of Energy Resources Engineering and Ali K. Abel-Rahman is a professor. All authors affiliated to Egypt- Japan University of Science and Technology E-JUST, New Borg Elarab, Alexandria 21934, Egypt.

on adsorption cooling systems with adsorbent pairs of activated carbon with ammonia, methanol, ethanol, hydrogen, nitrogen and diethyl ether pitch based activated carbon (Maxsorb III) with R134a, R507A and n-butane and activated carbon /CO₂ respectively. Their review showed that the highest adsorption capacity for activated carbon/hydrogen pair was 0.055g/g at 30°C and 6 bar, for activated carbon fibers /nitrogen pair was 0.75g/g at -4°C, for activated carbon /diethyl ether pair was 0.00139g/g at 50°C and 0.1 bar, for activated carbon /R134a pair was 2g/g at 30°C and 8 bar, for activated carbon /R507a pair was 1.3g/g at 20°C, for activated carbon /n-butane pair was 0.8g/g at 35°C and 2.3 bar and for activated carbon /CO₂ pair was 0.084g/g at 30°C and 1 bar respectively. They also concluded that the maximum COP of the cooling systems was 0.8 for activated carbon/ethanol pair and the performances of the potential adsorption cooling systems using carbon are still not satisfied. From their work it can be noted that the refrigerants R134a and R507a have high global warming potential (GWP), also n-butane, hydrogen, methanol, ethanol and diethyl ether are highly flammable gases and ammonia is a highly toxic refrigerant. Solmus et al. [4] have successfully provided a numerical investigation of coupled heat and mass transfer inside the adsorbent bed of a silica gel/water adsorption cooling unit, using the local volume averaging method. They developed a transient one-dimensional local thermal non-equilibrium model, which accounts for both internal and external mass transfer resistances. Askalany et al. [5] have carried out an experimental study on adsorption-desorption characteristics of granular activated carbon/R134a pair. Throughout their experiments the temperature of the pairs was about 25°C. The experimental results of [5] showed that increasing the temperature of the adsorbent leads to a decrease on the maximum adsorption capacity until reaches to 0.53kg_{R134a}/kg_{carbon} at 60°C for a period of 450s. The maximum adsorption capacity was found to be 1.68kg_{R134a}/kg_{carbon} at 25°C after 1000 s. Also they concluded that the granular activated carbon and R134a could be used as adsorption pair in an adsorption cooling system. Shmroukh et al. [6] presented compared and summarized the state-of-the-art in the application of the adsorption refrigeration working pairs in both classical and modern adsorption pairs. They reported that the maximum adsorption capacity for the classical working pairs was 0.259kg/kg for activated carbon/methanol and that for the modern working pairs was 2kg/kg for maxsorb III/R-134a. Also, they concluded that, the performances of the adsorption working pairs of adsorption cooling systems are still need further investigations as well as developing

adsorption pairs having higher sorption capacity with low or no impact on environmental, to build compact, efficient, reliable and long life performance adsorption chillier. Moreover, future researches need to be focused on designing the adsorption system that provide efficient heating and cooling for the adsorbent materials through distributing the adsorbent material over heat exchanger surface, to allow good heat and mass transfer between the adsorbent and the refrigerant.

Throughout the literature clearly found that all studies on adsorption capacity experiments were done on packed bed adsorbers, producing dead zones inside the adsorber without enough and efficient heat and mass transfer process. As the experiments with packed bed adsorbate produce inapplicable results such as very high values of adsorption pairs capacity which deviate from the real adsorption refrigeration systems. Therefore, this study is focus on developing more effective in heat and mass transfer processes for the adsorbate to obtain applicable adsorption capacity data. This will be carried out by using fin and tube heat exchanger core and the adsorbate is adhesive over its surface and located as the core of the adsorber. The main aims from the present experimental study are to estimate experimentally the maximum adsorption capacity for six different adsorption refrigeration working pairs. The pairs are activated carbon powder/R-134a, activated carbon powder/R-407c, activated carbon powder/R-507A, activated carbon granules/R-507A, activated carbon granules/R-407c and activated carbon granules/R-134a, at different adsorption temperatures of 25, 30, 35 and 50 °C. This will be carried out by using fin and tube adsorber heat transfer core to increase the heat and mass transfer process between the refrigerant and the adsorbent.

II. EXPERIMENTAL SETUP, MEASUREMENTS, PROCEDURES, DATA REDUCTION AND ERROR ANALYSIS

A. Experimental Setup

A detailed schematic diagram of the test facility with the adsorber (adsorbent tank) heat transfer core is presented in Fig. 1. The test facility mainly consists of adsorber, refrigerant tank, water tank, vacuum pump and piping system.

The adsorber outer frame is a 2mm thickness galvanized steel tank with dimensions of 7*5*23 cm. It is insulated by a 2.5cm thickness glass wool and foam insulators, and it's contain the adsorbent heat and mass transfer core that shown in Fig. 2. The adsorbent heat and mass transfer core is a rectangular aluminum fin and tube heat exchanger with a coppertube and the adsorbent material is adhesive over the heat exchanger outer surface.

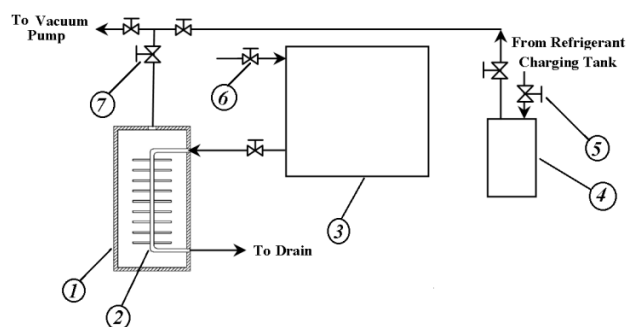
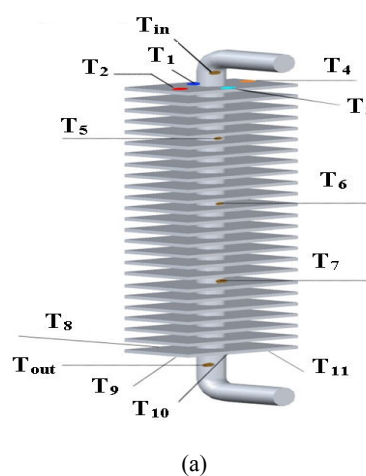

Fig. 1 Schematic diagram of the experimental set up of this study, 1) Adsorber, 2) Heat exchanger core, 3) Cooling and heating Water tank, 4) Refrigerant container, 5) Refrigerant charging valve, 6) Water flow control valves, 7) Refrigerant charge/discharge control valves



(b)



(c)



(d)

Fig. 2 Heat exchanger core assembly (a) temperature measuring points, (b) Photograph before adhesive the adsorbent, (c) Photograph after adhesive the activated carbon powder and (d) Photograph after adhesive the granular activated carbon

The refrigerant container is a 2mm thickness galvanized steel tank with 10*10*20cm in dimension, the refrigerant charging valve is welded to its top. The tank is insulated by a 2.5cm thickness glass wool insulator. The Charged refrigerant is from DuPont company refrigerant (canned in Egypt by Risk Brothers company), the refrigerant properties extracted from tables downloaded from the official website of DuPont company.

The water tank is a 2mm thickness galvanized steel tank with 30*30*30cm in dimension with its cover. It is equipped by a water heater and a thermostat. Cooling and heating water is stored in this tank, to initiate the adsorption and desorption processes. The tank is insulated by a 2.5cm thickness glass wool insulator. The flowing water temperature is adjusted by a thermostat ranging from 0°C to 200°C, with uncertainty of \pm (0.625% of full scale), it is connected by a contactor to connect and separate the heating coil of 1 kW which fixed at the bottom of the water tank at the required temperature. All the system main components and pipes are insulated by glass wool and insulation foam.

The adsorber is vacuumed by a vacuum pump that is a single-phase RV3 type. This vacuum pump used for vacuuming the system before each adsorption experiment, preventing air presence in the system, to assure that the whole gas in the system is the refrigerant only.

B. Measurements

In this section a brief description of the instruments used for measurement of temperature, flow rate and pressure are given. All temperatures have been measured by using type T thermocouple (copper, constantan). The voltage output was introduced to a data acquisition device (NEC, DC6100 model) having a maximum of 60 channels, which by turn is connected to a computer for controlling and recording the measured temperature data of measuring points at the same time. Two sizes of thermocouple wires were used; the first size is a 0.1 mm in diameter, which has the junction in contact with the component which temperature is to be measured. The second type is an extension thermocouple wire (Type T) of diameter 0.32mm used to connect the 0.1mm wire diameter thermocouple some distance away from the component to keep the splicing junction from being heated using the method used by [7] which might results in secondary effects that change the temperature reading to the data acquisition device.

All thermocouple junctions had uncertainty of \pm (0.05% of reading +0.5°C), these thermocouple junctions made by removing the insulation layer by using fine sanding sheet then twisting the wire ends, then the junctions were connected the needed measuring points by a very thin adhesive epoxy layer.

The refrigerant pressure was measured by a pressure gauge fixed on the top of the adsorber. The range of this gauge was from -1 to 15 bar absolute, with uncertainty of \pm 0.25 bar or \pm (0.833% of full scale).

The mass of the refrigerant entering the adsorbent tank is measured by an electronic balance of 10kg maximum reading and 0.1g sensitivity, with uncertainty of \pm 0.1g or \pm (0.001% of full scale).

The volume flow rate of the water exiting from water tank to the adsorbent tank is adjusted to be (0.33l/min or 1l/3min), it is measured by laboratory graded glass bottle (500 ml with 5 ml minimum scale), with uncertainty of \pm 5ml or \pm (1% of full scale) and stop watch.

C. Experimental Procedures

For all experiments, the following procedure was followed:

1. All the 16 points thermocouples (Type T) are connected by plugs and connectors to the same type leading wires to the data logger.
2. The whole system is evacuated (charging tank, adsorbent tank and piping system) by a vacuum pump to the minimum possible vacuum pressure (25-30 kPa). The adsorber weight is recorded after this step.
3. The target refrigerant for the experiment is charged to the refrigerant container by the charging valve at the top of the container, this container is weighted during charging process until charging 100 g refrigerant.
4. The charging valve is then closed tightly to prevent refrigerant leakage.
5. The adsorbent tank pressure is measured the pressure gauge
6. Mass of the refrigerant entered the adsorbent tank is measured by the electronic balance.
7. The flow rate of water exiting from water tank to the adsorbent tank is measured by laboratory graded glass bottle.
8. The water tank is filled to a fixed level then its valves are closed and heating process take place to the required temperature. After that, the inlet valve to water tank and exit valve to adsorbent tank is opened to the specific water flow rate.
9. The electronic balance is operated and the data logger is connected to the computer to present the data, and the reading interval is set to be every 60sec. This step is continues until both the balance and thermocouples readings are stable and reach steady state.
10. For the adsorption experiments, the refrigerant container valve is slightly opened then the adsorption process readings are started until the balance reading reach to a constant value. This means the adsorption equilibrium or the adsorbent material cannot adsorb more refrigerant. Then the adsorbent tank is evacuated by the vacuum

pump to draw out all un-adsorbed refrigerant mass was fill the adsorbent tank internal space. This to ensure that there is no refrigerant mass inside the tank except the adsorbed refrigerant quantity. Then the flexible pipe which fixed at the top of the tank is disconnected and adsorber is weighted the tank. The weight difference between step 2 and this step reading is consider as the exact adsorbed refrigerant quantity. Then the flexible pipe is reconnected and evacuated before open the adsorbent tank valve to reject air, then the valve is opened to be ready for desorption experiment.

11. For the desorption experiment, the refrigerant will return back to its tank by heating the adsorbent. This process is continued until all the adsorbed refrigerant is desorbed from the adsorbent tank and the balance reading reach to be stable and fixed value that nearly equal or a little bit more than the adsorption experiment initial reading. This slightly higher is due to the residual refrigerant in adsorbent pores (hystercis) which is difficult to rejected by desorption only but need vacuum process.
12. The adsorbent tank valve is closed and the flexible houses are disconnected and the tank is left until reach stable weight reading. Finally, the flexible houses are reconnected and evacuated before opening the adsorbent tank valve in order to reject air. After that the valve is opened and the test rig is ready for a new experiment.
13. The number of performed adsorption and desorption experiments were 50 (20 adsorption experiments and 30 desorption experiments). The controlled variable in these experiments are the adsorption and desorption temperatures. The adsorption temperature are 25°C, 30°C, 35°C and 50°C while the desorption temperature are 70°C, 80°C and 85°C respectively. The adsorption and desorption conditions chosen to nearly simulate the actual operating conditions in the practical adsorption refrigeration systems.

The activated carbon powder adsorbent (Norit SA SUPER) used in the experiments was provided by Norit Nederland B.V. Company [Norit Data Sheets]. It is with an extra fine particle size and it as produced by steam activation of dedicated vegetable raw materials. The quantity of activated carbon powder adsorbent used in the experiments was 44.9 g. Its characteristics are summarized in Table I. The granular activated carbon adsorbent (Norit GCN 1240) used in the experiments was provided by Norit Nederland B.V. Company [Norit Data Sheets], it was produced from coconut shells by steam activation. The quantity of granular activated carbon adsorbent used in the experiments was 139.6 g. Its characteristics are summarized in Table II.

TABLE I
ACTIVATED CARBON POWDER CHARACTERISTICS

Total surface area	1150	m ² /g
Apparent density	250	m ³ /kg
Average particle size	5	µm

TABLE II
GRANULAR ACTIVATED CARBON CHARACTERISTICS

Total surface area	1150	m ² /g
Apparent density	510	m ³ /kg
Average particle size	0.6	mm

The refrigerants which used with this adsorbent are:

- 1- R-134a which is a Hydrofluorocarbon (HFC), its GWP (global warming potential) is 1300 and it has zero ODP (ozone depletion potential) [8].
- 2- R-507A which is an Azeotropic mixtures, it is consists of two refrigerants (HFC-143a 50% and HFC-125 50% by weight) having different properties but behaving as a single substance. Its GWP (global warming potential) is 3300 and it has zero ODP (ozone depletion potential) [8].
- 3- R-407c which is a Nonazeotropic mixtures, it is consists of three refrigerants (HFC-32 23%, HFC-125 25% and HFC-134a 52% by weight) having different volatiles, its GWP (global warming potential) is 1526 and it has zero ODP (ozone depletion potential) [8].

D. Data Reduction

Refrigerant adsorbed mass is obtained from simple subtraction equation was used to determine the mass of the adsorbed refrigerant in adsorption capacity experiment of certain adsorption pair, the initial mass of the adsorption bed subtracted from the final mass of the whole adsorption bed after each run as follows.

$$m_{\text{Ref}} = m_{\text{Bed}} - m_{\text{initial}} \quad (1)$$

where m_{Ref} is the adsorbed refrigerant in kg, m_{Bed} is the final adsorption bed mass after each run in kg and m_{initial} is the initial mass of the adsorption bed before the experiment in kg.

Adsorption pairs capacity is obtained from simple dividing equation to determine the adsorption pairs capacity as the mass of the adsorbed refrigerant in the adsorbent material divided by the mass of the adsorbent as follows.

$$X = \frac{m_{\text{Ref}}}{m_{\text{ads}}} \quad (2)$$

where X is the adsorption pairs capacity of the tested working pair in kg_{Ref} / kg_{ads}, m_{Ref} is the mass of the adsorbed refrigerant in kg and m_{ads} is the initial mass of the adsorbent in the adsorption bed in kg.

E. Error Analysis

The adsorbed refrigerant and the adsorption capacity values are determined values as they are not measured directly. Therefore, there are errors in their values, however, the error analysis for theses determined values are calculated by using the following general method for propagating uncertainties through calculations [9].

$$E_z = \sqrt{(\alpha_1 * E_1)^2 + (\alpha_2 * E_2)^2 + \dots + (\alpha_i * E_i)^2} \quad (3)$$

$$\alpha_i = \frac{\partial z}{\partial x_i} \quad (4)$$

where E_i is the uncertainty in quantity x_i and z is the result.

The whole uncertainty analysis is presented in Tables III and IV.

TABLE III
ERROR ANALYSIS OF THE MEASURED PARAMETERS

Variable	Symbol	Error
Temperature	T	± 0.05 % of reading + 0.5 °C
Pressure	P	± 0.25 bar
Water flow rate	Q_w	± 5 ml
Adsorption bed final mass	m_{Bed}	± 0.1 g
Adsorption bed initial mass	$m_{initial}$	± 0.1 g

TABLE IV
ERROR ANALYSIS OF THE DETERMINED PARAMETERS

Variable	Symbol	Error
Refrigerant Mass	m_{Ref}	± 0.141361541 g or ± 1 % of the result
Adsorption Capacity	X	± 0.000124624 g/g or ± 0.067056106 % of the result

III. RESULTS AND DISCUSSION

For the Activated carbon granules / R-507A pair, Fig. 3 presents the relation between the measured temperatures inside the adsorber, the atmosphere temperature and water outlet from the adsorber as a function of time for the case of adsorption temperature is set to 25°C. From the figure, it can be seen that the temperature inside the adsorber increased in the beginning of the adsorption processes. This is due to condensation of refrigerant molecules inside the adsorbent pores. As the time pass the temperature is decreased, and, this due to there is no more refrigerant adsorbed. Also, from the figure the water outlet temperature is increased with the time and this due to heat transferred from the adsorbent as it's the heat of adsorption, this increase in water outlet temperature continued even with the decrease in the temperature inside the adsorber, this is because the temperature inside the adsorber is still higher than water outlet temperature. Also it can be seen that the atmosphere temperature was nearly constant.

Figs. 4 to 6 illustrate the relation between the measured temperature inside the adsorber, the atmosphere temperature and water outlet from the adsorber with time for the cases of desorption temperature are 70°C, 80°C and 85°C respectively corresponding to 25°C adsorption temperature case. As shown in the figures, in all experiments the adsorbent temperature inside the adsorber are decreases in the beginning of the desorption processes. This is due to the evaporation of refrigerant molecules from the adsorbent pores. Thereafter, the temperature is increased again and this due to no more refrigerant is desorbed from the adsorbent material. Also, it can be seen that as the desorption temperature increased the desorption time decreased, this is due to the increasing of the rate of refrigerant desorption by increasing the desorption temperature. Figs. 4 and 5 indicated that the maximum desorption occurred at a time around 600 seconds, but for Fig. 6 this maximum desorption occurred at a time around 350 seconds as faster than in the former Figs. 4 and 5, this is due to the increase of desorption temperature. Also, as indicated from the figures, as the desorption temperature increased the

difference between the adsorbent temperature inside the adsorber and the water outlet temperature increased. Finally, as shown in the figures, the water outlet temperature was decreased due to heat transferred required for desorption process. This decrease in water outlet temperature continued even with the increase in the temperature inside the adsorber, this is because the water outlet temperature is still higher than the temperature inside the adsorber.

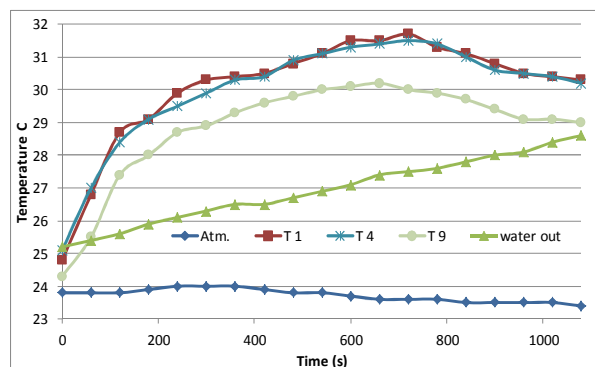

Fig. 3 The measured temperature inside the adsorber, the atmosphere temperature and water exit from the adsorber with time at 25°C adsorption

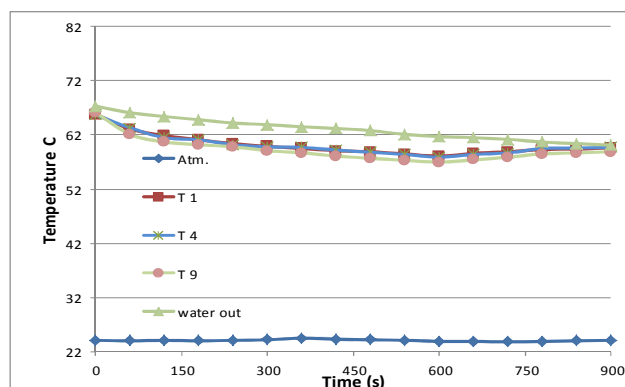

Fig. 4 The measured temperature inside the adsorber, the atmosphere temperature and water exit from the adsorber with time at 70°C desorption correspondence to 25°C adsorption temperature case

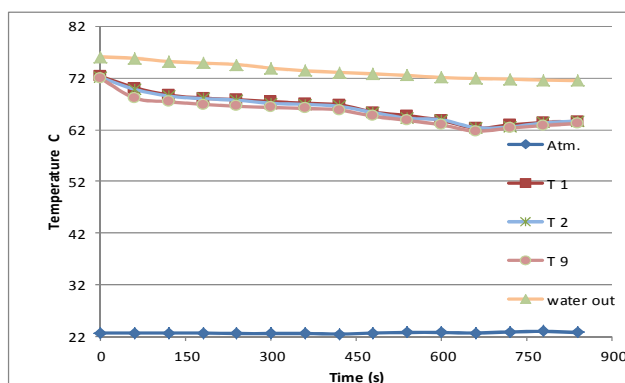

Fig. 5 The measured temperature inside the adsorber, the atmosphere temperature and water exit from the adsorber with time at 80°C desorption correspondence to 25°C adsorption temperature case

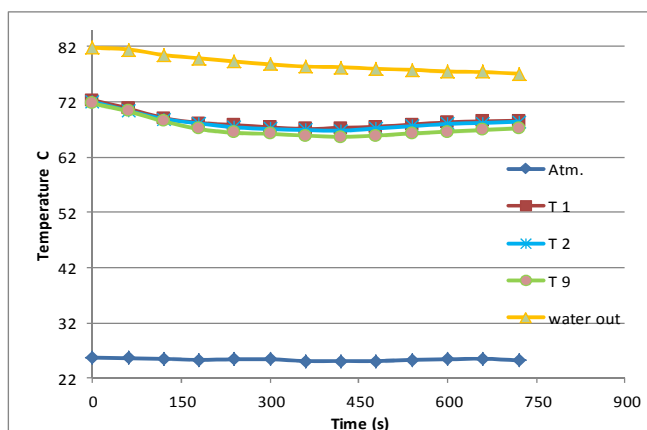

Fig. 6 The measured temperature inside the adsorber, the atmosphere temperature and water exit from the adsorber with time at 85 °C desorption correspondence to 25 °C adsorption temperature case

Also it can be seen that the atmosphere temperature was nearly constant.

From these results it is clear that all other adsorption pair's experiments nearly have the same trend in each condition of adsorption and desorption process.

Fig. 7 illustrates the relation between the adsorption capacity of the all tested pairs (activated carbon powder - R-134a, activated carbon powder - R-407c, activated carbon powder - R-507, activated carbon granules - R-507 activated carbon granules - R-407c and activated carbon granules - R-134a) at different adsorption temperatures. As shown in the figure, the adsorption capacity decreased with increase the adsorption temperature. From the measured data the following results shown in Fig. 7 are obtained. The maximum adsorption capacity of activated carbon powder/R-134a pair was 0.8352 kg/kg at 25°C and became 0.4343 kg/kg at 25°C for activated carbon powder/R-407c pair while it is 0.3163 kg/kg at 25°C for activated carbon powder/R-507A pair. Also, the results showed that the maximum adsorption capacity is 0.2006 kg/kg at 25°C for activated carbon granules/R-507A pair, 0.1583 kg/kg at 25°C for activated carbon granules/R-407c pair and 0.4986 kg/kg at 25°C for activated carbon granules/R-134a. The main obtained results for all pairs is that, at adsorption temperature of 25°C the maximum adsorption capacity is found to be 0.8352 kg/kg for activated carbon powder with R-134a and the minimum adsorption capacity found to be 0.1583 kg/kg for activated carbon granules with R-407c. While, at adsorption temperature of 50°C the maximum adsorption capacity is found to be 0.3207 kg/kg for activated carbon powder with R-134a and the minimum adsorption capacity found to be 0.0609 kg/kg for activated carbon granules with R-407c.

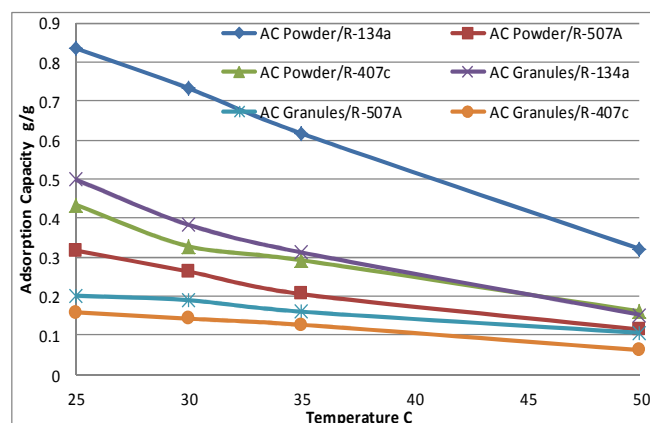

Fig. 7 Adsorption capacity of the whole six adsorption pairs with respect to the adsorption temperature

IV. CONCLUSION

This study is experimentally targeting to develop effective in heat and mass transfer processes for the adsorbate to obtain applicable adsorption capacity data. This is done by using fin and tube heat exchanger core and the adsorbate is adhesive over its surface and located as the core of the adsorber. This experimentally estimates the maximum adsorption capacity for six different adsorption refrigeration working pairs. The pairs are activated carbon powder/R-134a, activated carbon powder/R-407c, activated carbon powder/R-507A, activated carbon granules/R-507A, activated carbon granules/R-407c and activated carbon granules/R-134a, at different adsorption temperatures of 25, 30, 35 and 50°C. The following is concluded from the results:

- At adsorption temperature of 25°C the maximum adsorption capacity is found to be 0.8352kg/kg for activated carbon powder with R-134a and the minimum adsorption capacity found to be 0.1583 kg/kg for activated carbon granules with R-407c. While, at adsorption temperature of 50°C the maximum adsorption capacity is found to be 0.3207kg/kg for activated carbon powder with R-134a and the minimum adsorption capacity found to be 0.0609kg/kg for activated carbon granules with R-407c.
- The activated carbon powder/R-134a pair is highly recommended to be used as adsorption refrigeration working pair because of its higher maximum adsorption capacity than the other tested pairs, to produce a compact, efficient and reliable for long life performance adsorption refrigeration system.

ACKNOWLEDGMENT

The first author would like to acknowledge Ministry of Higher Education (MoHE) of Egypt for providing a scholarship to conduct this study as well as the Egypt Japan University of Science and Technology (E-JUST) for offering the facility and tools needed to conduct this work.

REFERENCES

- [1] A. O. Dieng and R. Z. Wang "Literature review on solar adsorption technologies for ice-making and air conditioning purposes and recent developments in solar technology", *Renewable and Sustainable Energy Reviews* Vol. 5, pp. 313–342, 2001.
- [2] K. Habib, B. B. Saha, A. Chakraborty, S. Koyama and K. Srinivasan "Performance evaluation of combined adsorption refrigeration cycles", *International journal of refrigeration* vol. 34, pp. 129-137, 2011.
- [3] A. A. Askalany, M. Salem, I.M. Ismail, A H H. Ali and M. G. Morsy "A review on adsorption cooling systems with adsorbent carbon". *Renewable and Sustainable Energy Reviews* vol. 16, pp. 493– 500, 2012.
- [4] I. Solmus, D. A. S. Rees, C. Yamalı, D. Baker and B. Kaftanoglu "Numerical investigation of coupled heat and mass transfer inside the adsorbent bed of an adsorption cooling unit". *International Journal of Refrigeration* vol. 35, pp. 652-662, 2012.
- [5] A. A. Askalany, M. Salem, I.M. Ismail, A. H. H. Ali, M.G. Morsy. "Experimental study on adsorption-desorption characteristics of granular activated carbon/R134a pair". *International Journal of Refrigeration* vol. 35, pp. 494–498, 2012.
- [6] A. N. Shmroukh, A. H. H. Ali and A. K. Abel-Rahman. "Adsorption refrigeration working pairs: The state-of-the-art in the application". Submitted to International Conference on Fluid Mechanics, Heat Transfer and Thermodynamics, Paris, France November 06-07, 2013.
- [7] A. H. H. Ali and Y. Hanaoka. "Experimental study on laminar flow forced-convection in a channel with upper V-corrugated plate heated by radiation". *International Journal of Heat and Mass Transfer* vol. 45, pp. 2107–2117, 2002.
- [8] I. Dincer and M. Kanoğlu *Refrigeration Systems And Applications*. A John Wiley and Sons, Ltd., Publication. 2010, Second Edition.
- [9] John R. Taylor. *Error Analysis: The study of uncertainties in physical measurements*. University Science Books, Publication. 1997, Second Edition.