

Coordinated Design of PSS and STATCOM for Power System Stability Improvement Using Bacteria Foraging Algorithm

Kyaw Myo Lin, Wunna Swe, Pyone Lai Swe

Abstract—This paper presents the coordinated controller design of static synchronous compensator (STATCOM) and power system stabilizers (PSSs) for power system stability improvement. Coordinated design problem of STATCOM-based controller with multiple PSSs is formulated as an optimization problem and optimal controller parameters are obtained using bacteria foraging optimization algorithm. By minimizing the proposed objective function, in which the speed deviations between generators are involved; stability performance of the system is improved. The nonlinear simulation results show that coordinated design of STATCOM-based controller and PSSs improve greatly the system damping oscillations and consequently stability improvement.

Keywords—Bacteria Foraging, Coordinated Design, Power System Stability, PSSs, STATCOM.

I. INTRODUCTION

THE power transfer in an integrated power system is constrained by transient stability, voltage stability and small signal stability. These constraints limit a full utilization of available transmission corridors. Flexible AC Transmission System (FACTS) is the technology that provides the needed corrections of the transmission functionality in order to fully utilize the existing transmission facilities and hence, minimizing the gap between the stability limit and thermal limit [1]. Recently, there has been a surge of interest the development and use of FACTS controllers in power transmission systems [2]-[6]. These controllers utilize power electronics devices to provide more flexibility to AC power systems.

FACTS devices also play an important role in controlling reactive power flow to the power network, the system voltage fluctuations and stability. STATCOM is a member of FACTS family that is connected in shunt with the system. Even though the primary purpose of STATCOM is to support bus voltage by injecting or absorbing reactive power, it is also capable of improving the power system stability [7]. PSSs are auxiliary control devices on synchronous generators, used in conjunction with their excitation systems to provide control signals toward

enhancing the system damping and extending power transfer limits. PSSs are one of the most common controls used to damp out power system oscillations. When a STATCOM is present in a power system to support the bus voltage, a supplementary damping controller could be designed to modulate the STATCOM bus voltage in order to improve damping of system oscillations [8]. But, the interaction among PSSs and STATCOM-based controller may enhance or degrade the damping of certain modes of rotor's oscillation. To improve overall system performance, many researches were made on the coordination between PSSs and FACTS power oscillation damping controller [9]-[12].

A number of conventional techniques have been reported in the literature pertaining to design problems of conventional PSSs: the eigenvalue assignment, mathematical programming, gradient procedure for optimization and also the modern control theory. Unfortunately, the conventional techniques are time consuming as they are iterative and require heavy computation burden and slow convergence.

In addition, the search process is susceptible to be trapped in local minima and the solution obtained may not be optimal [13]. The application of the decentralized modal control method for pole placement in multi-machine power system utilizing FACTS devices is developed in [14]. The parameter tuning of a PID controller for a FACTS based stabilizer employing multi-objective evolutionary algorithm is illustrated in [15]. A comprehensive assessment of the effects of the PSSs and FACTS devices when applied independently and also through coordinated application is carried out in [16]. Coordinated design of STATCOM-based controller and PSSs using particle swarm optimization techniques under severe and small disturbance conditions is presented in [17].

Recently, global optimization technique like genetic algorithm (GA) has attracted the attention in the field of controller parameter optimization [18]. Unlike other techniques, GA is a population based search algorithm, which works with a population of strings that represent different solutions. Therefore, GA has implicit parallelism that enhances its search capability and the optima can be located swiftly when applied to complex optimization problems. Unfortunately, recent research has identified some deficiencies in GA performance [19]. This degradation in efficiency is apparent in applications with highly *epistatic* objective functions (i.e. where parameters being optimized are highly correlated). Also, the premature convergence of GA degrades its performance and reduces its search capability. Bacteria

Mr. Kyaw Myo Lin is with Department of Electrical Power Engineering, Mandalay Technological University, Patheingyi, Mandalay, Myanmar (phone: +95-2-57360; fax: +95-2-88702; e-mail: kmlep2381@gmail.com).

Dr. Wunna Swe is with Technological University of Monywa, Saging Region, Myanmar (e-mail: tumonywa2011@gmail.com).

Dr. Pyone Lai Swe is with Department of Electrical Power Engineering, Mandalay Technological University, Patheingyi, Mandalay, Myanmar (e-mail: pyonelai@gmail.com).

foraging optimizing algorithm (BFOA) is proposed as a solution to the above mentioned problems and drawbacks [20]. Moreover, BFOA due to its unique dispersal and elimination technique can find favorable regions when the population involved is small. These unique features of the algorithms overcome the premature convergence problem and enhance the search capability. Hence, it is suitable optimization tool for power system controllers.

In this paper, the coordinated design of STATCOM-based controller and PSSs has been carried out. The structure of this paper is as follow. The overview on BFOA is discussed in first section. In Section II, the design problem of PSSs and STATCOM-based controller to improve power system stability is demonstrated and is transformed into an optimization problem. System under study is discussed in Section III. BFOA technique is employed to search for the optimal PSSs and STATCOM controller parameters, which is discussed in Section IV. And then, the computer simulation results for system under study are presented to demonstrate the effectiveness of the proposed controller to improve the power system dynamic stability. Finally, a conclusion is made based on the simulation results under different scenarios.

II. BACTERIA FORAGING OPTIMIZATION

Bacteria foraging optimization method was invented by Kelvin M. Possino [20] motivated by the natural selection which tends to eliminate the animals with poor foraging strategies and favor those having successful foraging strategies. The survival of species in any natural evolutionary process depends upon their fitness criteria, which relies upon their food searching and motile behavior. The law of evolution supports those species who have better food searching ability and either eliminates or reshapes those with poor search ability.

The genes of those species who are stronger gets propagated in the evolution chain since they possess ability to reproduce even better species in future generations. So a clear understanding and modeling of foraging behavior in any of the evolutionary species leads to its application in any nonlinear system optimization algorithm. The foraging strategy of *Escherichia coli* bacteria present in human intestine can be explained by four processes, namely chemotaxis, swarming, reproduction, and elimination dispersal [21], [22].

A. Chemotaxis

The characteristic of movement of bacteria in search of food can be defined in two ways, i.e., swimming and tumbling together known as chemotaxis. A bacterium is said to be 'swimming' if it moves in a predefined direction, and 'tumbling' if moving in an altogether different direction. Mathematically, tumble of any bacterium can be represented by a unit length of random direction $\phi(j)$ multiplied by step length of that bacterium $C(i)$. In case of swimming, this random length is predefined.

B. Swarming

For the bacteria to reach at the richest food location (i.e., for the algorithm to converge at the solution point), it is desired that the optimum bacterium till a point in the search period should try to attract other bacteria so that together they converge at the desired location (solution point) more rapidly. To achieve this, a penalty function based upon the relative distances of each bacterium from the fittest bacterium till that search duration, is added to the original cost function. Finally, when all the bacteria have merged into the solution point, this penalty function becomes zero. The effect of swarming is to make the bacteria congregate into groups and move as concentric patterns with high bacterial density.

C. Reproduction

The original set of bacteria, after getting evolved through several chemotactic stages reaches the reproduction stage. Here, best set of bacteria (chosen out of all the chemotactic stages) gets divided into two groups. The healthier half replaces with the other half bacteria, which gets eliminated, owing to their poorer foraging abilities. This makes the population of bacteria constant in the evolution process.

D. Elimination and Dispersal

In the evolution process, a sudden unforeseen event can occur, which may drastically alter the smooth process of evolution and cause the elimination of the set of bacteria and/or disperse them to a new environment. Most ironically, instead of disturbing the usual chemotactic growth of the set of bacteria, this unknown event may place a newest set of bacteria nearer to the food location. In its application to optimization, it helps in reducing the behavior of *stagnation* (i.e., being trapped in a premature solution point or local optima) often seen in such parallel search algorithms. The detailed mathematical derivations as well as theoretical aspect of this new concept are presented in [21], [23].

III. PROBLEM FORMULATION

A. Power System Model

A power system model which can be modeled by a set of nonlinear differential equation is:

$$\dot{X} = f(X, U) \quad (1)$$

where X is the vector of the state variables and U is the vector of input variables. In this study, $X = [\delta, \omega, E'_q, E'_{fd}, V_f]^T$ and U is the PSSs and STATCOM output signals. Here, δ and ω are rotor angle and speed, respectively. Also E'_q, E'_{fd} and V_f are the internal, the field and excitation voltages respectively. In the design of PSSs and STATCOM, the linearized incremental models around an equilibrium point are usually employed. Therefore, the state equation of a power system with n machines and m PSSs and STATCOM can be written as:

$$\dot{X} = AX + BU \quad (2)$$

where A is a $(5n \times 5n)$ matrix and equals $\partial f/\partial X$ while B is a $(5n \times m)$ matrix and equals $\partial f/\partial U$. Both A and B are evaluated at a certain operating point. X is a $(5n \times 1)$ state vector and U is an $(m \times 1)$ input vector.

B. Coordinated Design of STATCOM-Based Controller and PSSs

The commonly used lead-lag structure is chosen as STATCOM-based controller which is shown in Fig. 1. The structure consists of a gain block, a signal washout block and two-stage phase-compensation block. The phase-

compensation block provides the appropriate phase-lead characteristics to compensate for the phase lag between input and the output signals. The signal washout block serves as a high-pass filter which allows signals associated with oscillations in input signal to pass unchanged. From the viewpoint of the washout function, the value of washout time constant is not critical and may be in the range 1-20s [1]. In the structure, the washout time constants T_{wS} and the time constants T_{2S} , T_{4S} are usually prespecified. In the present study, $T_{wS}=10$ s and $T_{2S}=T_{4S}=0.3$ s are used. The controller gain K_S and the time constants T_{1S} and T_{3S} are to be determined.

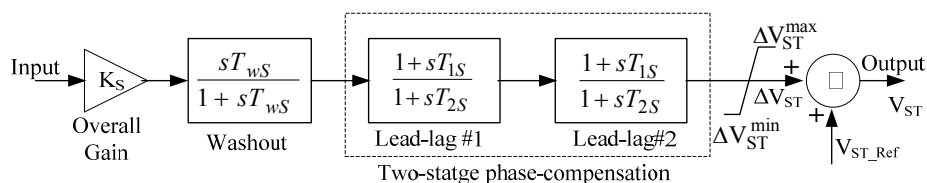

Fig. 1 Structure of STATCOM-based controller

The generic PSS block of the SPS toolbox is used to add damping to the rotor oscillations of the synchronous machine by controlling its excitation. The output signal of the PSS is used as an additional input, V_S to the excitation system block. The PSS input signal can be either the machine speed

deviation or acceleration power. The PSS model consists of a low-pass filter, a general gain, a washout high-pass filter, a phase-compensation system, and an output limiter as shown in Fig. 2.

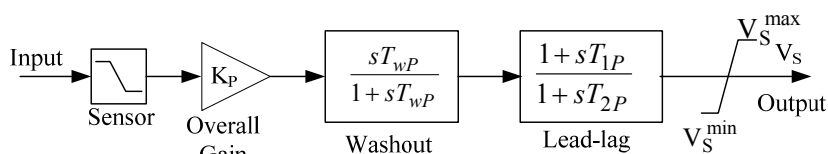

Fig. 2 Structure of the generic power system stabilizer

The general gain K_P determines the amount of damping produced by the stabilizer. The washout high-pass filter eliminates low frequencies that are present in the input signal and allows the PSS to respond only to changes in the input. The phase-compensation system is used to compensate the phase lag between the excitation voltage and the electrical torque of the synchronous machine. In this structure, a washout time constant $T_{wP} = 3$ s is used. The time constants T_{1P} and T_{2P} are to be determined.

C. Objective Function

It is worth mentioning that the PSSs and STATCOM-based controllers are designed to minimize the power system oscillations after a large disturbance so as to improve the power system stability. In this research work, an integral time absolute error (ITAE) of the speed error deviations is taken as the objective function expressed as follows:

$$J = \int_{t=0}^{t=t_{sim}} (|\Delta\omega|) t \cdot dt \quad (3)$$

where $\Delta\omega$ denotes the speed deviation for a set of controller parameters, and t_{sim} is the time range of the simulation.

For objective function calculation, the time-domain simulation of the nonlinear power system model is carried out for the simulation period. It is aimed to minimize this objective function in order to improve the system response in terms of the settling time and overshoots. In this paper, it is aimed to minimize the proposed objective function, J . The problem constraints are the PSSs and STATCOM controller parameter bounds. Therefore, the design problem can be formulated as the following optimization problem.

$$\text{Minimize } J = \int_{t=0}^{t=t_{sim}} (|\Delta\omega|) t \cdot dt \quad (4)$$

$$\begin{aligned} &K_S^{\min} \leq K_S \leq K_S^{\max} \\ &T_{1S}^{\min} \leq T_{1S} \leq T_{1S}^{\max} \\ &T_{3S}^{\min} \leq T_{3S} \leq T_{3S}^{\max} \\ &K_{Pi}^{\min} \leq K_{Pi} \leq K_{Pi}^{\max} \\ &T_{1Pi}^{\min} \leq T_{1Pi} \leq T_{1Pi}^{\max} \\ &T_{2Pi}^{\min} \leq T_{2Pi} \leq T_{2Pi}^{\max} \end{aligned} \quad (5)$$

Typical ranges of the optimized parameters are (1~150) for gain, K and (0.06~2) for time constant, T. This study focuses on coordinated design of PSSs and STATCOM using BFOA algorithm. The aim of optimization is to search for the optimum controller parameters setting that enhance the damping characteristics of the system.

IV. SYSTEM UNDER STUDY

In this study, the proposed strategy is evaluated with the Western Electricity Coordinating Council (WECC) system. This system presents oscillating modes poorly damped [24]. Much attention has been paid to this system since blackout occurred on 10 August 1996 and oscillations appeared on 4 August 2000. A schematic diagram of the WECC system is shown in Fig. 3, where parameters and data used in tests were extracted from Section 2.10 of the book [25]. The participation matrix can be used in mode identification.

Table I shows the eigenvalues and frequencies associated with the rotor oscillation modes of the system. Examining Table I indicates that 0.2371 Hz mode is the inter-area mode with G1 swinging against G2 and G3. The 1.2955 Hz mode is the inter-machine oscillation local to G2. Also, the 1.8493 Hz mode is the inter-machine mode local to G3. The positive real part of eigenvalue of G1 indicates instability of the system. To access the effectiveness and robustness of the proposed method over a wide range of loading conditions, three different cases designated as light, normal and heavy loading level conditions are considered. The generator and system loading levels at these cases are given in Table II.

TABLE I
EIGNEVALUES AND FREQUENCIES ASSOCIATED WITH THE ROTOR
OSCILLATION MODES

Generator	Eigenvalues(λ_i)	Frequencies(f_i)	Damping ratio(ζ)
G1	+0.15±j1.49	0.2371	-0.1002
G2	-0.35±j8.14	1.2955	0.0430
G3	-0.67±j11.62	1.8493	0.0575

In order to determine the suitable placement of the STATCOM in the system, two strategies below will be adapted. The first one based on studying the effect of load percentage while the second is concerned with the line outage on system voltage. Tables III and IV show the effect of load percentage and line outage on bus voltages of the system.

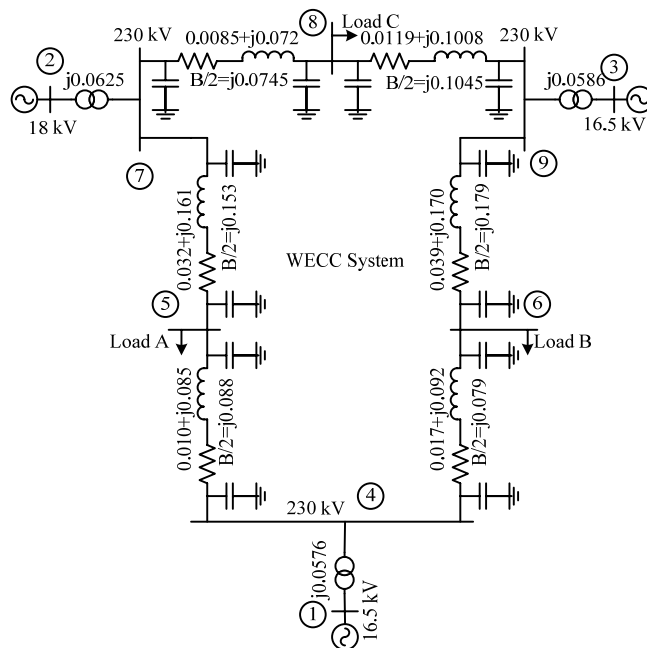

Fig. 3 WECC three machine-nine bus power system
(System is based on 100 MVA)

TABLE II
LOADING CONDITIONS FOR THE SYSTEM (PER UNIT)

Generator/ Load	Light		Normal		Heavy	
	P	Q	P	Q	P	Q
G1	0.9649	0.2330	1.7164	0.6205	3.5730	1.8143
G2	1.0000	-	1.3600	0.0665	2.2000	0.7127
G3	0.4500	-	0.8500	0.1086	1.3500	0.4313
Load A	0.7000	0.3500	1.2500	0.5000	2.0000	0.9000
Load B	0.5000	0.3000	0.9000	0.3000	1.8000	0.6000
Load C	0.6000	0.2000	1.0000	0.3500	1.6000	0.6500
Local load at G1	0.6000	0.2000	1.0000	0.3500	1.6000	0.6500

TABLE III
EFFECT OF LOAD PERCENTAGE ON LOAD BUS VOLTAGES

% load	0.25	0.50	0.75	1.00	1.25	1.50	1.75
Bus 4	1.0573	1.0474	1.0375	1.0256	1.0126	0.9975	0.9799
Bus 5	1.0593	1.0403	1.0192	0.9956	0.9691	0.9389	0.9306
Bus 6	1.0643	1.0487	1.0315	1.0127	0.9917	0.9681	0.9410
Bus 7	1.0500	1.0434	1.0534	1.0258	1.0143	1.0005	0.9839
Bus 8	1.0535	1.0425	1.0300	1.0159	0.9998	0.9819	0.9599
Bus 9	1.0508	1.0456	1.0359	1.0324	1.0241	1.0144	1.0029

TABLE IV
EFFECT OF LINE OUTAGE ON LOAD BUS VOLTAGES

Line outage	4-5	4-6	5-7	6-9	7-8	8-9
Bus 4	1.0388	1.0282	0.9956	1.0047	1.0159	1.0224
Bus 5	0.8389	0.9988	0.9380	0.9678	0.9897	0.9897
Bus 6	1.0203	0.9418	0.9748	0.9639	0.9994	1.0087
Bus 7	0.9878	1.0223	1.0170	1.0156	1.0192	1.0100
Bus 8	0.9895	1.0063	1.0010	1.0054	0.9690	0.9783
Bus 9	1.0244	1.0167	1.0189	1.0234	1.0126	1.0338

It can be noticed that the voltages are affected significantly at buses numbered 5 and 6 respectively which are load buses. The reasons that cause the significant voltage change are the connection of these buses with the longest line in the system which has greater resistances and reactances than others. Consequently, the choice of buses number 5 or 6 for placing the STATCOM controller is expected to be more suitable choice because both of them are close to G1 which causes the system instability due to its unstable mechanical mode. Moreover, bus number 5 is the worst one and will be considered in this paper as the best location for installing the STATCOM controller.

V. BACTERIA FORAGING ALGORITHM

In case of BFOA technique, each bacterium is assigned with a set of variable to be optimized and is assigned with random values within the universe of discourse defined through upper and lower limit between which the optimal value is likely to fall. In this paper, optimization using BFOA is carried out to find the parameters of lead-lag circuits for PSSs and STATCOM coordinated design problem. The algorithm of proposed technique involves two steps.

A. Step-1: Initialization

Variables needed for the algorithm are initialized. They include following:

- (i). p is the number of parameters to be optimized.
- (ii). S is the number of bacteria to be used for searching the total region.
- (iii). N_s is the swimming length after which tumbling of bacteria will be undertaken in a chemotactic loop.
- (iv). N_c is the number of iteration to be undertaken in a chemotactic loop ($N_c > N_s$).
- (v). N_{re} is the maximum number of reproduction to be undertaken.
- (vi). N_{ed} is the maximum number of elimination and dispersal events to be imposed over the bacteria.
- (vii). P_{ed} is the probability with which the elimination and dispersal will continue.
- (viii). $P(1-p, 1-S, 1)$ is the location of each bacterium which is specified by random number on $[-1, 1]$
- (ix). The value of $C(i)$ which is assumed to be constant in this case for all the bacteria to simplify the design strategy.
- (x). The values of $d_{attract}$, $\omega_{attract}$, $h_{repellent}$ and $\omega_{repellent}$.

B. Step-2: Iterative Algorithm for Optimization

This section models the bacterial population chemotaxis, swarming, reproduction, elimination and dispersal (initially, $j = k = l = 0$). For the algorithm updating, θ^i automatically results in updating of P .

- (i). Elimination-dispersal loop: $l = l + 1$
 - (ii). Reproduction loop: $k = k + 1$
 - (iii). Chemotaxis loop: $j = j + 1$
- For $i = 1, 2, \dots, S$, calculate cost function value for each bacterium i as follows;

- Compute value of cost function $J(i, j, k, l)$

Let $J_{sw}(i, j, k, l) = j(i, j, k, l) + J_{cc}(\theta^i(j, k, l), P(j, k, l))$. J_{cc} is defined by the following equation.

$$J_{cc}(\theta, P(j, k, l)) = \sum_{i=1}^S J_{cc}(\theta, \theta^i(j, k, l))$$

$$= \sum_{i=1}^S \left[-d_{attract} \exp \left(-\omega_{attract} \sum_{m=1}^p (\theta_m - \theta_m^i)^2 \right) \right]$$

$$+ \sum_{i=1}^S \left[-d_{attract} \exp \left(-\omega_{repellent} \sum_{m=1}^p (\theta_m - \theta_m^i)^2 \right) \right]$$

- Let $J_{last} = J_{sw}(i, j, k, l)$ to save this value since one may find a better cost via a run.
 - End of *For* loop.
- For $i = 1, 2, \dots, S$, take the tumbling/swimming decision.
- Tumble: generate a random vector $\Delta(i) \in \mathbb{R}^p$ with each element $\Delta_m(i), m = 1, 2, \dots, p$.

- Move:

$$\text{Let } \theta^i(j+1, k, l) = \theta^i(j, k, l) + C(i) \frac{\Delta(i)}{\sqrt{\Delta^T(i)\Delta(i)}}$$

Fixed step size in the direction of tumble for bacterium i is considered. Compute $J(i, j+1, k, l)$ and

$$J_{sw}(i, j+1, k, l) = J(i, j+1, k, l)$$

$$+ J_{cc}(\theta^i(i, j+1, k, l), P(j+1, k, l)).$$

- Swim:
 1. Let $m = 0$ (counter for swim length).
 2. While $m < N_s$ (have no climbed down too long)

Let $m = m + 1$.

If $J_{sw}(i, j+1, k, l) < J_{last}$ (if doing better), let $J_{sw}(i, j+1, k, l) < J_{last}$ and

$$\text{Let } \theta^i(j+1, k, l) = \theta^i(j, k, l) + C(i) \frac{\Delta(i)}{\sqrt{\Delta^T(i)\Delta(i)}}$$

and use this $\theta^i(j+1, k, l)$ to compute the new $J(i, j+1, k, l)$

3. Else, let $m = N_s$.

This is the end of the while statement.

- Go to next bacterium ($i+1$) if $i \neq S$.
- (iv). If $j < N_{re}$, go to step (iii). In this case, continue chemotaxis, since the life of bacteria is not over.
- (v). Reproduction
 - For the given k and l , for each $i = 1, 2, \dots, S$,

Let $J_{health}^i = \min_{j \in \{1, \dots, N_c\}} \{J_{sw}(i, j, k, l)\}$ be the health of the bacterium i (a measure of how many nutrients it got over its life time and how successful it was at avoiding noxious substance). Sort bacteria in order of ascending cost J_{health} .

➤ The $S_r = S/2$ bacteria with highest J_{health} values die and other S_r bacteria with the best value split.

(vi). If $k < N_{re}$, go to step (ii). In this case, one has not reached the number of specified reproduction steps, so one starts the next generation in the chemotactic loop.

(vii). Elimination-dispersal: if $i = 1, 2, \dots, N$, with probability P_{ed} , eliminate and disperse each bacterium, and this result in keeping the number of bacteria in the population constant. To do these, if you eliminate a bacterium, simply disperse one to a random location on the optimization domain. If $l < N_{re}$, then go to step (ii); otherwise end.

The detail mathematical derivations as well as theoretical aspect of this new concept are presented in [21], [22]. BFO parameters applied in the research are shown in Table V.

TABLE V
BFO PARAMETERS

Sr. No.	Parameters	Value
1	Number of bacteria	10
2	Number of chemotactic steps	10
3	Number of elimination and dispersal events	2
4	Number of reproduction steps	4
5	Probability of elimination and dispersal	0.25
6	$d_{attract}$	0.01
7	$\omega_{attract}$	0.04
8	$\eta_{repellent}$	0.01
9	$\omega_{repellent}$	10

VI. RESULTS AND DISCUSSIONS

The convergence rate for proposed algorithm on coordinated design is shown in Fig. 4. The speed deviations of generators are selected as the input signal of the STATCOM-based controller. Accelerating power of the individual generators is chosen as the input signals for all PSSs. The parameters of the PSSs and the STATCOM-based controller are optimally tuned using BFO technique as explained above.

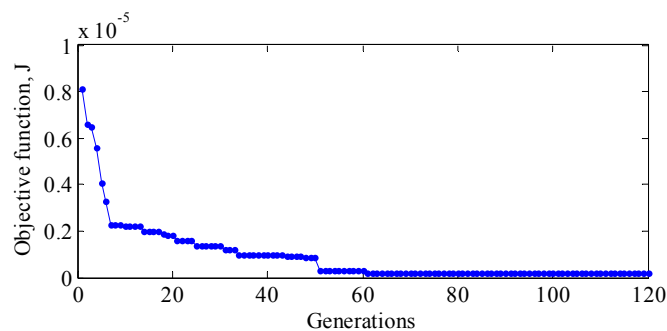

Fig. 4 Convergence of objective function

The algorithm is run keeping limiting value of objective function at 10^{-7} . The obtained parameters of STATCOM-based controller and PSSs are shown in Table VI. In this table, different controller parameters set values, coordinated as well as uncoordinated design, based on time domain objective function are given.

TABLE VI
BFO OPTIMIZED PARAMETERS OF STATCOM-BASED CONTROLLER AND PSSS

	Coordinated			
	STATCOM	PSS1	PSS2	PSS3
K	103.652	20.081	3.593	4.287
T_1	0.263	0.283	0.218	0.245
T_2	0.489	0.132	0.012	0.129
	Uncoordinated			
	STATCOM	PSS1	PSS2	PSS3
K	65.335	7.007	5.543	7.928
T_1	0.907	0.405	0.372	0.375
T_2	0.669	0.274	0.199	0.296

Table VII illustrates the system eigenvalues and damping ratios of mechanical mode with three different loading conditions. It is clear that the proposed coordinated controller shifts substantially the electromechanical mode eigenvalues to the left of the S -plane and the values of damping factors with the proposed coordinated controller are significantly improved for light, normal and heavy loading, respectively. The proposed coordinated controller greatly enhances the system stability and improves the damping characteristics of electromechanical modes.

TABLE VII
MECHANICAL MODES AND DAMPING RATIO UNDER DIFFERENT LOADING AND DIFFERENT CONTROLLERS

Loading	Generator	Coordinated	Uncoordinated
Light load	G1	-3.11±j6.68, 0.4357	-3.71±j8.61, 0.3992
	G2	-3.85±j8.64, 0.4192	-1.25±6.23, 0.1986
	G3	-1.04±j0.68, 0.9915	-0.54±j0.62, 0.5731
Normal load	G1	-3.99±8.66, 0.4315	-3.41±j8.69, 0.3749
	G2	-4.13±j6.78, 0.5473	-1.48±6.49, 0.2145
	G3	-1.14±j0.69, 0.8333	-0.43±j0.73, 0.4998
Heavy	G1	-3.95±j8.68, 0.4271	-3.76±8.66, 0.3983
	G2	-3.91±j6.54, 0.5318	-1.29±j6.64, 0.2785
	G3	-1.63±j0.78, 0.9153	-0.99±j0.84, 0.7129

In order to verify the effectiveness and robustness of the proposed coordinated controller under severe disturbance, two scenarios are considered as follows:

- **Scenario 1:** Applying 110 ms three-phase short circuit at bus 7 and line 5-7 is considered out of service.
- **Scenario 2:** Applying 170 ms three-phase short circuit at bus 9 and line 6-9 is considered out of service.

A. Response for Light Load Condition under Scenario 1

Time domain simulation is performed on the light load condition of system with a three-phase fault (scenario 1) applied the end of the circuit between bus 5 and 7 (near bus 7) that is cleared by tripping the line 5-7 (out of service) successfully after 1.0 second. Figs. 5 and 6 show the speed deviations of generators. These figures indicate the capability

of the proposed coordinated controller in reducing settling time and damping the power system oscillation. Hence, the proposed coordinated controller extends the power system stability limit and the power transfer capability.

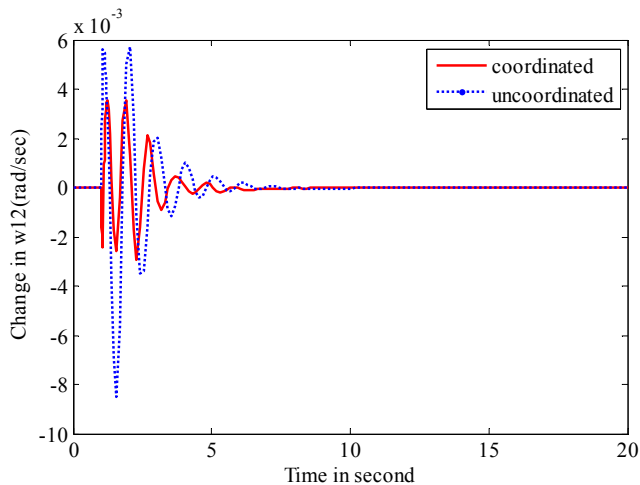

Fig. 5 Response of $\Delta\omega_{12}$ for light load condition with evaluation of scenario 1

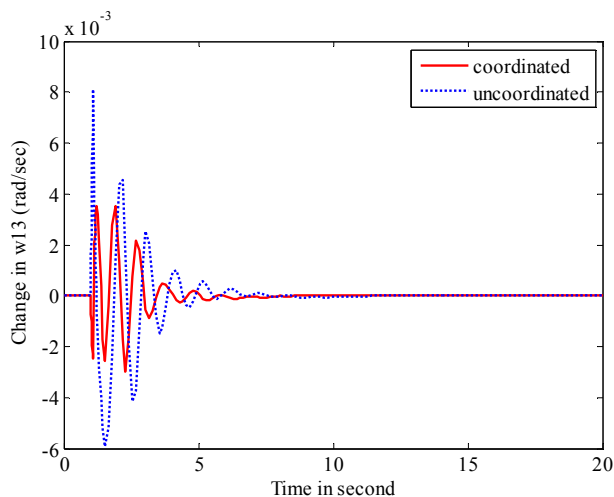

Fig. 6 Response of $\Delta\omega_{13}$ for light load condition with evaluation of scenario 1

B. Response for Heavy Load Condition under Scenario 2

Figs. 7 & 8 illustrate the evaluation of scenario 2 with heavy load condition.

These figures show the system response at heavy loading condition applying a three phase fault of 170 ms duration at 1.0 s near bus 9 and considering out of service of line 6-9. The results of these studies show that the proposed coordinated controller has an excellent capability in damping power system oscillations and enhances greatly the dynamic stability of the power system. From the results, it is seen that proposed method of tuning results in better response.

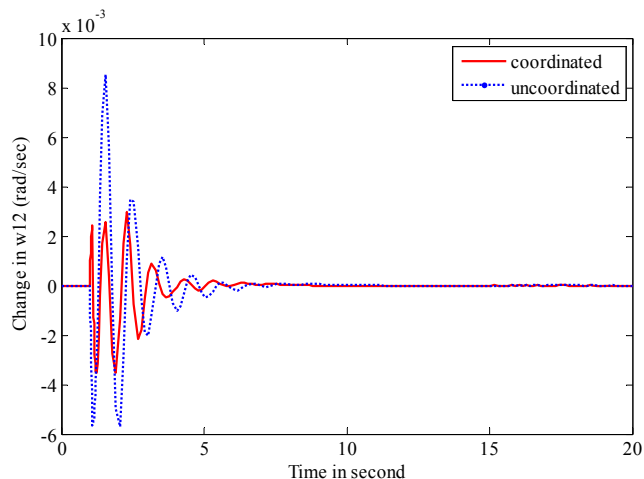

Fig. 7 Response of $\Delta\omega_{12}$ for heavy load condition with evaluation of scenario 2

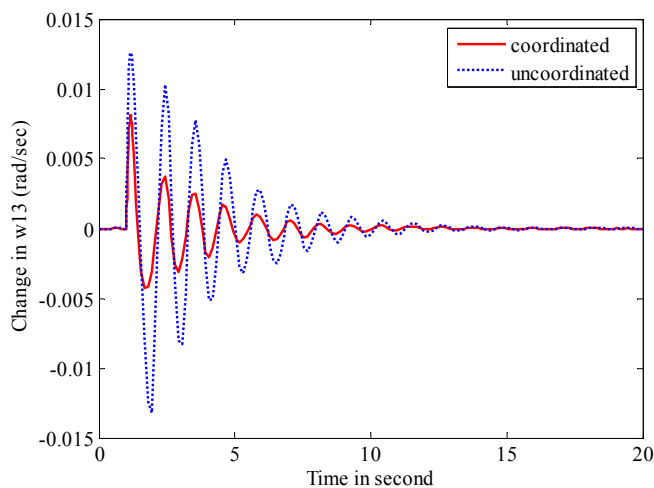

Fig. 8 Response of $\Delta\omega_{13}$ for heavy load condition with evaluation of scenario 2

VII. CONCLUSIONS

In this study, a robust design algorithm for the coordinated tuning of STATCOM damping controller and PSSs in multi-machine power system is proposed. The design problem of the proposed controller is formulated as an optimization problem and BFOA is employed to search for optimal parameters. By minimizing the time domain objective function, in which deviations in speed are involved; stability performance of the system is improved. The results clearly show that in large power systems, PSSs and STATCOM-based controller can successfully increase damping of power system oscillations and the system with STATCOM-based stabilizer is more robust and stable after disturbances. In this study, considering different scenarios helps to comprehensive study of STATCOM under real world disturbances. Considering real world type of disturbances such as three phase short circuit guarantees the results in order to implementation of controller in industry.

ACKNOWLEDGMENT

The authors would like to thank to Myanmar Engineering Society (MES) for energizing to prepare this research. Moreover, they would like to thank to Prof. Dr. Myint Thein, Pro-Rector of Mandalay Technological University (MTU) for his constant support and never-ending enthusiasm. The authors are also thankful to Head of Department and their colleagues at Department of Electrical Engineering, MTU for being friendly and for always being there to offer help. After that, they would like to thank to Prof. Dr. Khin Aye Win (Retired) and Prof. Daw Than Than Win of Yangon Technological University and Dr. Tun Naing, Chief Engineer, Myanmar Electric Power Enterprise for providing the required data and information. The authors greatly express sincere thanks to all persons whom will concern to support in preparing this paper and for their technical feedback on important issues.

REFERENCES

- [1] P. Kundur, *Power System Stability and Control*, McGraw-Hill, 1994.
- [2] Y.S. Lee, S.Y. Sun, "STATCOM controller design for power system stabilization with sub-optimal control and strip pole assignment," *Int. J. Electr. Power Energy Syst.*, vol. 24(3), 2002, pp. 771-779.
- [3] M. A. Abido, "Optimal design of power system stabilizers using particle swarm optimization," *IEEE Trans. on Energy Conv.*, vol. 17(3), 2002, pp. 406-413.
- [4] Y. L. Abdel-Magid, M. A. Abido, "Coordinated design of a PSS and a SVC based controller to enhance power system stability," *Int. J. Electr. Power Energy Syst.*, vol. 25(9), 2003, pp. 695-704.
- [5] J. Baskaran, V. Palanisamy, "Optimal location of FACTS devices in a power system solved by a hybrid approach," *Int. J. Nonlinear Analysis*, vol. 11, 2006, pp. 2094-2102.
- [6] S. Kodsı, C. Canizares, M. Kazerani, "Reactive current control through SVC for load power factor correction," *Int. J. Electr. Power System Research*, vol. 76(9-10), 2006, pp.701-708.
- [7] H. F. Wang, "Phillips–Heffron model of power systems installed with STATCOM and applications," *IEE Proc. Generation, Transmission and Distribution*, vol. 146, 1999, pp. 521–527.
- [8] N.G. Hingorani, L. Gyugyi, *Understanding FACTS: Concepts and Technology of Flexible AC Transmission Systems*, IEEE Press, New York, 2000.
- [9] J.M. Ramirez, I. Castillo, "PSS and FDS simultaneous tuning," *Int. J. Electr. Power System Research*, vol. 68, 2004, pp. 33–40.
- [10] Q. J. Liu, Y. Z. Sun, T. L. Shen, Y.H. Song, "Adaptive nonlinear coordinated excitation and STATCOM controller based on Hamiltonian structure for multi-machine power system stability enhancement," *IEE Proc. Generation, Transmission and Distribution*, vol. 150, 2003, pp. 285–294.
- [11] X. Lei, X. Li, D. Povh, "A nonlinear control for coordinating TCSC and generator excitation to enhance the transient stability of long transmission," *Int. J. Electr. Power System Research*, vol. 59, 2001, pp. 103–109.
- [12] L. J. Cai, I. Erlich, "Simultaneous coordinated tuning of PSS and FACTS damping controller in a large power system," *IEEE Trans. on Power System*, vol. 20, 2005, pp. 294–300.
- [13] Y. L. Abdel-Magid, M.A. Abido, "Robust coordinated design of excitation and TCSC-based stabilizers using genetic algorithms," *Int. J. Electr. Power Energy System*, vol. 69, 2004, pp. 129–141.
- [14] M. A. Furini, A.L.S. Pereira, P. B. Araujo, "Pole placement by coordinated tuning of power system stabilizers and FACTS POD stabilizers," *Int. J. Electr. Power Energy System*, vol. 33(3), 2011, pp. 615–622.
- [15] S. Panda, "Multi-objective PID controller tuning for a FACTS based damping stabilizer using non-dominated sorting genetic algorithm-II," *Int. J. Electr. Power Energy System*, vol. 33(7), 2011, pp.1296–1308.
- [16] E. S. Ali, S. M. Abd-Elazim, "Coordinated design of PSSs and TCSC via bacterial swarm optimization algorithm in a multi-machine power system," *Int. J. Electr. Power Energy System*, vol. 36(1), 2012, pp. 84–92.
- [17] S. Panda, N. P. Padhy, "Optimal location and controller design of STATCOM for power system stability improvement using PSO," *J. Franklin Institute*, vol. 345, 2008, pp. 166-181.
- [18] Y. L. Abdel-Magid, M. A. Abido, S. Al-Baiyat, A. H. Mantawy, "Simultaneous stabilization of multi-machine stabilizers via genetic algorithms" *IEEE Trans. on Power System*, vol. 14(3), 1999, pp. 1428-1439.
- [19] D. B. Fogel, "Evolutionary Computation toward a New Philosophy of Machine Intelligence," IEEE, New York, 1995.
- [20] Passino.K.M, "Biomimicry of bacterial foraging for distributed optimization and control", *IEEE Control Syst. Mag.*, vol.22(3), 2002, pp.52-67.
- [21] D. H. Kim, A. Abraham, J. H. Cho, "A hybrid genetic algorithm and bacterial foraging approach for global optimization," *Information Science J.*, vol. 177(18), 2007, pp. 3918–3937.
- [22] E. S. Ali, S. M. Abd-Elazim, "Bacteria foraging optimization algorithm based load frequency controller for interconnected power system," *Int. J. Electr. Power Energy System*, vol. 33(3), 2011, pp. 633-638.
- [23] K. M. Passino, "Biomimicry of bacterial foraging for distributed optimization and control," *IEEE Control System Mag.*, vol. 22(3), 2002, pp. 52-67.
- [24] G. Revel, A. E. Leon, D. M. Alonso, J. L. Moiola, "Bifurcation analysis on a multi-machine power system model," *IEEE Trans. on Circuits System*, Regular papers, vol. 57(4), 2010, pp. 937-948.
- [25] P. M. Anderson, A. A. Fouad, *Power System Control and Stability*, IEEE Press, Power System Engineering Series, EE.UU, 1993.