

Current Density Effect on Nickel Electroplating Using Post Supercritical CO₂ Mixed Watts Electrolyte

Chun-Ying Lee, Mei-Wen Wu, Van Cuong Nguyen, and Hung-Wei Chuang

Abstract—In this study, a nickel film with nano-crystalline grains, high hardness and smooth surface was electrodeposited using a post supercritical carbon dioxide (CO₂) mixed Watts electrolyte. Although the hardness was not as high as its Sc-CO₂ counterpart, the thin coating contained significantly less number of nano-sized pinholes. By measuring the escape concentration of the dissolved CO₂ in post Sc-CO₂ mixed electrolyte with the elapsed time, it was believed that the residue of dissolved CO₂ bubbles should closely relate to the improvement in hardness and surface roughness over its conventional plating counterpart. Therefore, shortening the duration of electroplating with the raise of current density up to 0.5 A/cm² could effectively retain more post Sc-CO₂ mixing effect. This study not only confirms the roles of dissolved CO₂ bubbles in electrolyte but also provides a potential process to overcome most issues associated with the cost in building high-pressure chamber for large size products and continuous plating using supercritical method.

Keywords—Additive-free electrolyte, electroplating, nickel, supercritical CO₂.

I. INTRODUCTION

ELECTRODEPOSITION of metallic coating in the electrolyte mixed with the supercritical carbon dioxide (Sc-CO₂) has been recently stated as a new method for fabricating the nano-material products. The special characteristics of these Sc-CO₂ plated nickel films include improved uniformity, high hardness, nano-sized grains, bright appearance, smooth surface, and high corrosion resistance [1]-[5]. Furthermore, by adding copper particle suspension into the Sc-CO₂ electrolyte mixture, the copper was able to electrodeposit in high aspect ratio, nano-scaled gap (70 nm in diameter) without any defects [6]. Thereby, the excellent wettability of Sc-CO₂ electrolyte/solution promises itself as a viable vehicle for plating/coating nano-sized scale electronic devices, which would be the inaccessible regions of the conventional methods.

Above the critical point at a pressure of 73atm (~7.4MPa) and a temperature of 31.1°C, the supercritical state of CO₂ can

be formed. In the supercritical state, with proper agitation, the CO₂ bubbles are introduced into electrolyte forming a mixture that includes both gaseous and liquid phases. With an addition of surfactant, the supercritical CO₂ droplets have been observed in nano scale (~10nm) and in some cases the stability can exist over 24hrs. [7]. Those nano-sized bubbles in aqueous electrolyte are postulated as the key factors in transforming the direct current into a periodic one and assisting desorption of the generated hydrogen simultaneously in the electrodeposition process. Both the size reduction and population increase of CO₂ bubbles in Sc-CO₂ mixed electrolyte have been reported as the main reasons for refining grains and smoothening coating surface. Nonetheless, the circular marks observed on deposited surface was mentioned because of a formation of large size CO₂ bubbles [3].

Although having the aforementioned superior mechanical properties, the nickel coating prepared from Sc-CO₂ electroplating was found suffering higher tensile internal stress than from the conventional one. The internal stress increased when the CO₂ fraction in the reaction chamber was raised, i.e. more soluble CO₂ in aqueous electrolyte. The charging of CO₂/H₂ in the cavities during film formation under such a high pressure of Sc-CO₂ state constitutes one of the causes [8], [9]. In thin film applications, the internal stress of a deposition is crucial for its structural integrity. Furthermore, the electrodeposition under supercritical state of CO₂ demands a high pressure chamber, which is high in equipment cost especially for large workpiece and is difficult to implement for continuous plating. In a former study, instead of doing electrodeposition under the supercritical state of CO₂, electroplating was performed at atmospheric pressure in the post Sc-CO₂ mixed Watts electrolyte [10]. Although a high pressure mixing chamber is still required, the electrodeposition and mixing can be performed at different environments. This provides more flexibility in both mixing chamber and plating cell designs. Thus, some of the shortcomings of the Sc-CO₂ plating may be overcome. However, it was believed that the residue of dissolved CO₂ bubbles should closely relate to the improvement in hardness and surface roughness over its conventional plating counterpart. Therefore, shortening the duration of electroplating with the raise of current density up to 0.5A/cm² could effectively retain more post Sc-CO₂ mixing effect. The investigation on the feasibility of using post Sc-CO₂ electrodeposition can have potential in industrial applications.

C. Y. Lee is with the Department of Mechanical Engineering, National Taipei University of Technology, Taipei 10608, Taiwan (phone: +886-2-8773-1614; fax: +886-2-2771-7191; e-mail: leech@ntut.edu.tw).

M. W. Wu is with Chienkuo Technology University, Changhua 50015 (e-mail: mwwwu@cc.ctu.edu.tw).

V. C. Nguyen is with the Department of Mechanical Engineering, Vinh University of Technology Education, Vinh City, Vietnam (e-mail: cuongkvt@yahoo.com).

H. W. Chuang is with the Department of Mechanical Engineering, National Taipei University of Technology, Taipei 10608, Taiwan (e-mail: t100568027@ntut.edu.tw).

II. EXPERIMENTAL

A. Materials

The Watts bath electrolyte with the compositions shown in Table I was adopted in this study. All the chemicals of the Watts bath were purchased from First Chemical Co. Ltd, Taiwan and employed in the electrodeposition without further refinement. Carbon dioxide with minimum purity of 99.9% was acquired from CC Gaseous Corp., Taiwan. The circular copper plate with an area approximately 2cm^2 and thickness of 0.5mm was used as the working substrate, which is similar to the cross section size of the nickel anode.

TABLE I
THE EXPERIMENTAL PARAMETERS USED FOR THE POST-Sc-CO₂
ELECTROPLATING PROCESS IN THIS STUDY

Parameters	Sc-CO ₂ formation	Post Sc-CO ₂ Electroplating
Watts bath	NiSO ₄ ·6H ₂ O: 300 g/l, NiCl ₂ ·6H ₂ O: 50 g/l, H ₃ BO ₃ : 30 g/l	-
CO ₂ fraction, vol.%	30	-
Pressure, MPa	14	0.1
Temperature, °C	50	50
Agitation, rpm	500	500
Sc-CO ₂ mixing duration, min	30	-
Current density, A/cm ²	-	0.05-0.5

B. Experimental Apparatus and Method

The schematic diagram of the post Sc-CO₂ electroplating system used in this work is depicted in Fig. 1. The Sc-CO₂ forming chamber, which had a volume of approximately 190 cc, was made of stainless steel with inner Teflon lining for chemical inertness. The underneath magnetic agitator and a surrounding temperature controlled water jacket (not shown in Fig. 1) were used for mixing and maintaining the constant temperature of the inner chamber, respectively.

The nickel electroplating Watts solution of 125cc was first put into the Sc-CO₂ forming chamber as shown in Fig. 1 (a). With the chamber cap closed, liquid CO₂ was introduced into the chamber using a high pressure air driven liquid pump, Haskel DSF-60, and the chamber was pressurized to a predetermined pressure 14MPa, as depicted in Fig. 1 (b). The Sc-CO₂ mixture was agitated with a magnetic stirrer at a speed of 500 rpm for at least 30 min and then the pressure was released to atmosphere.

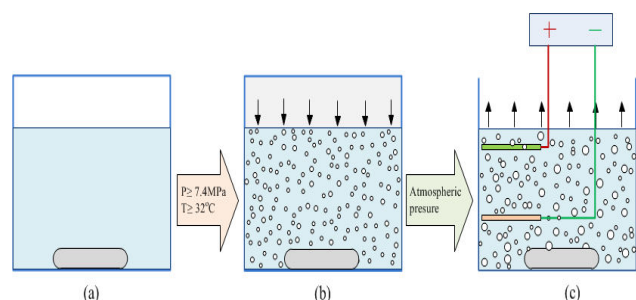

Fig. 1 Schematic of post Sc-CO₂ electroplating process (a) aqueous electrolyte (b) Sc-CO₂ and aqueous electrolyte mixing (c) plating with post Sc-CO₂ mixed electrolyte

Prior to deposition, the polished copper substrate working as the cathode later on was treated sequentially in 10 wt.% NaOH solution for degreasing, 10 wt.% HCl solution for surface activating and then rinsed in de-ionized water.

Inside the reaction chamber, the cathode and anode were arranged in horizontal orientation with a working distance of 2 cm for allowing adequate fluid sweeping on both electrode surfaces, as illustrated in Fig. 1 (c). Both the cathode and anode were connected to a programmable power supply, NF BP 4610, Japan, through titanium rods to the lead wires outside the chamber. The plating started as soon as the post Sc-CO₂ solution was maintained at the desired temperature. Each experiment was carried out in fresh solution and with parameters shown in Table I. After plating, the copper cathode with nickel coating was rinsed in deionized water, and then dried with warm stream of air.

It should be mentioned that if the electroplating was carried out directly in the bath of Fig. 1 (a), it was referred to the conventional plating. On the other hand, if in the configuration of Fig. 1 (b), it was denoted as the supercritical CO₂ (Sc-CO₂) electroplating.

C. Microstructural Examination

The surface morphology of the specimen was examined by a scanning electron microscope (SEM), the Carl Zeiss-SIGMA Essential, Germany. The further surface morphology and roughness measurement with atomic force microscope (AFM), Veeco CP-II, was carried out by using the ACCESS-PSS-160 probe within an area of $5\mu\text{m}$ square. The through-the-thickness micro hardness measurement was performed at cross section plane of the coating using a diamond pyramid indenter, the Mitutoyo HM-113 microhardness tester, at a load of 10g and loading duration of 15s. To avoid the cross influence between neighboring indentations, the required minimum spacing of four times the size of indentation was followed carefully.

D. Carbon Dioxide Release Measurement

The released CO₂ concentration from 135cc electrolyte solution, in the total exposed air volume of 430cc, was evaluated by using a portable CO₂ sensor, PASCO PS-2100, while kept agitating, as schematically shown in Fig. 2. The CO₂ sensor monitored the CO₂ concentration inside a measuring container while its contents were continuously refreshed by a circulating air pump to suck in gas mixture from the mixing chamber. The mixing chamber was closed with a cap having two ventilation holes to confine the escape of CO₂ to pass to the measuring container and provide the purge air for maintaining the pressure in the mixing chamber. The measured CO₂ concentration was sampled once a second and recorded in a personal computer. All measurements were carried out under the conditions of 500rpm stirring and nominal temperature of 50°C controlled by the surrounding water jacket.

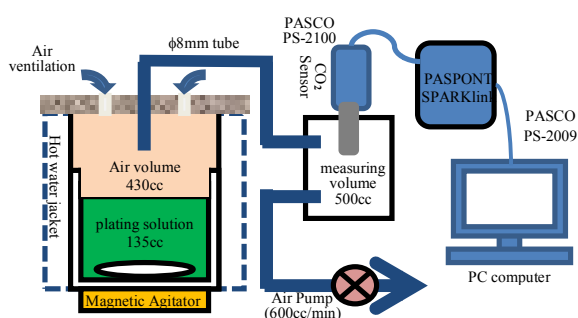

Fig. 2 The schematic setup for measuring the CO₂ release from the post-Sc-CO₂ mixed electrolyte

III. RESULTS

A. Surface Morphology of Coating

Shown in Fig. 3 are the surface SEM micrographs of the nickel coatings plated in different thicknesses by conventional and Sc-CO₂ methods. Film thickness was prepared from 5μm to 15μm with similar plating conditions. Under high magnification SEM, it is clearly observed the coarsening mechanisms with respect to thickness occurred herein. However, in post Sc-CO₂ coating, the diminishing of nano-pinholes through film thickening is revealed. The appearance shows that the nano-pinholes have been filled or covered by the subsequent deposition. This mechanism may be derived from the decelerating CO₂ released trend and the growing size of the bubbles in aqueous solution. The lower residual CO₂ concentration as well as the larger sized bubbles in aqueous solution may reduce the bubble's potential of being trapped for pinholes formation. Comparing with what prepared from the pristine conventional method, the surface morphology of the post Sc-CO₂ films is totally different. These discrepancies show the evidence of the accommodation of the crystal orientation, thus, properties of coating film. Clearly seen in Fig. 3 (a-5) and Fig. (b-5) have similar appearance between the coatings plated from real Sc-CO₂ and post Sc-CO₂ electrolyte whereas the one prepared from conventional electrolyte, Fig. 3 (c-5), is totally different. The presence of nano-sized pinholes on 5μm-thick films carried out from non-conventional methods implies the similar effects of CO₂ gas in aqueous electrolyte. However, the discrepancies are observed on the thicker films, as in Fig. 3 (a-15) and (b-15).

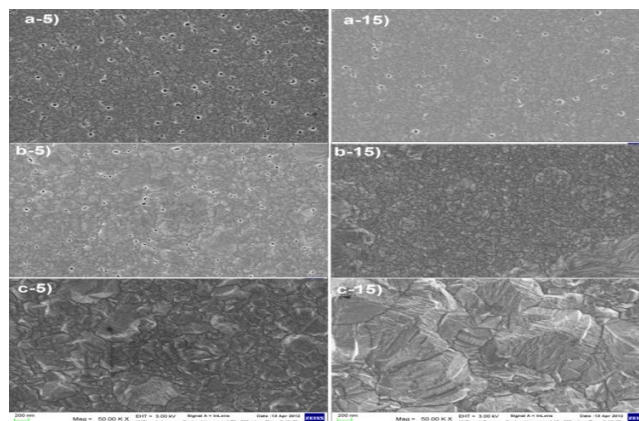

Fig. 3 SEM micrographs of nickel films plated in different thicknesses from a) Sc-CO₂, b) post Sc-CO₂ and c) conventional methods. The numbers after hyphen denote for film thickness in micrometer

Those similar tiny pinholes appeared on 5μm post Sc-CO₂ films (Fig. 3 (b-5)) would most likely be attributed to the presence of CO₂ bubbles inside electrolyte solution after Sc-CO₂ mixing. In the beginning, the size and density of bubbles in electrolyte would be alike to those of Sc-CO₂ condition. Once the plating process proceeds further, owing to the agitating assistance, the coalescence is improved [11] and larger bubbles in aqueous solution are formed. Thus, the adsorption of generated hydrogen as well as the sweeping efficiencies are improved accordingly and results in diminishing pinholes. In contrast, larger bubbles lose their engulfing function and the initial rough surface appeared. The rough surface appears on both of the conventional methods because there is no gas-assistance in the plating electrolyte. Thereby, the coatings obtained from pure Watts bath electrolyte, in this work, confirm that the effects are most likely from the presence of the CO₂ in the plating solution, which has been formed at the supercritical state. When the thickness of coating and the electrodeposited time are controlled, the desired result would be able to achieve accordingly.

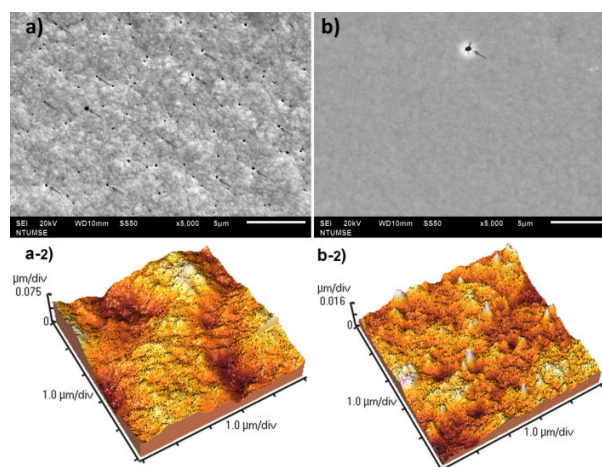

Fig. 4 SEM and AFM of 40 μm-thick nickel films prepared by electrolyte with addition of saccharin from a) Sc-CO₂ and b) post Sc-CO₂ conditions

B. Effects of Saccharin

In conventional electroplating method, saccharin is usually the organic additive playing the role of internal stress reducer, grain refiner, and smoothening agent for the Ni electrodeposit [12], [13]. The two former influences have also been observed in the internal stress examination mentioned in our previous papers [8], [9], whereas the last role is most likely inconsistent with those observed in the conventional plating method. Herein, when plated with similar Watts bath electrolyte in the presence of 2g/l saccharin, the nickel coating prepared from real Sc-CO₂ and post Sc-CO₂ solution appear totally different as seen in Fig. 4. The SEM micrographs are depicted in Fig. 4 (a-b) and its correlative AFM measured surface morphologies are shown in Fig. 4 (a-2) and (b-2), respectively. It is interesting to note that the coating plated from post Sc-CO₂ electrolyte is very bright smooth, and almost free of nano-pinholes. Meanwhile, the real Sc-CO₂ result is still rough and with high population of pinholes.

Clearly shown on the AFM images is the different surface morphology of these two coatings. Within a scanning range of 10 μ m square, the surface roughness, Ra, of the Sc-CO₂ coating is 25.01nm whereas the one plated from post Sc-CO₂ solution is only 3.65nm. Thus, the post Sc-CO₂ Watts bath solution with addition of saccharin would have potential in achieving smoother surface with pinhole-free than the real Sc-CO₂ plating counterpart. This occurrence implies the different role of saccharin in the Sc-CO₂ electroplating method. Therein, the influence of CO₂ in Sc-CO₂ mixture had perturbed the leveling role of the saccharin. Though, further studies on the roles of saccharin in post Sc-CO₂ electroplating will be helpful and useful for industrial applications.

C. Hardness of Coating

Fig. 5 presents the hardness on the cross section of nickel films with nominal total thickness of 100 μ m electroplated in different current densities using three different methods. The results are shown in Figs. 5 (a) and (b) for the hardness measured at 20 μ m and 70 μ m from the substrate interface, respectively. From both figures, it is clearly seen that the hardness of Sc-CO₂ coating was much higher than that of conventional one, which was consistent with the results reported in the literature [3], [4]. Moreover, within the range of current density from 10 to 40A/dm², the measured hardness remained nearly unchanged by the current density employed in both methods. However, for the post Sc-CO₂ method, the hardness at 20 μ m and 70 μ m were in different dependence on the current density. In Fig. 5 (a), the hardness of the coating deposited in higher current density showed improved result. The improvement in hardness diminished gradually as the current density was reduced. This current density dependency for the hardness was not observed for the 70 μ m result shown in Fig. 5 (b). The hardness remained more or less the same magnitude no matter what the current density employed in the electroplating. These different phenomena for the coating deposited at early and latter stages of the post Sc-CO₂ method revealed the diminishing influence from the mixing of electrolyte with Sc-CO₂. At higher current density, the coating

thickness grew faster in the same deposition time. Within shorter elapsed time from the end of Sc-CO₂ mixing, the electrolyte still possessed the benefit from the periodic plating with dissolved CO₂ bubbles [2]. This beneficial effect should decay with the elapsed time while the oversaturated CO₂ escaped gradually from the electrolyte. At 70 μ m thickness, it took too long to deposit for both lower and higher current densities. Therefore, the beneficial effect from the dissolution of Sc-CO₂ in the electrolyte was absence. More will be discussed in the latter section.

IV. DISCUSSION

A. The Effect of Dissolved CO₂ in the Electrolyte

Fig. 6 presents the hardness of the coating, measured electrolyte temperature and CO₂ concentration associated with the elapsed plating time for the post Sc-CO₂ electroplating. The current density used was 0.5A/cm² and at the end of 15min the coating thickness was approximately 15 μ m. The hardness was measured through the thickness of the coating such that the one near the substrate interface was not reported because of the influence from the substrate. It can be seen that the hardness remained nearly twice that of conventional one at the first 6min of plating. However, this strengthening effect diminished quickly after 6min and the hardness returned to the level of conventional plating after 15min. Accompanying the measured CO₂ concentration, the decrement of the escaped CO₂ from the electrolyte was observed. In other words, under the constant total amount of dissolved CO₂ during Sc-CO₂ mixing, the remaining CO₂ in the electrolyte was diminishing with the elapsed time. In this circumstance, through the coalescence and release of CO₂ from electrolyte, bubble radius and density would be altered accordingly. Thus, the effects of periodic characteristics would also be varied in time. In electrodeposition, the hardness of coating decreases with increasing thickness is associated with the coarsening grains (Fig. 3) because of the coarsening effect [14].

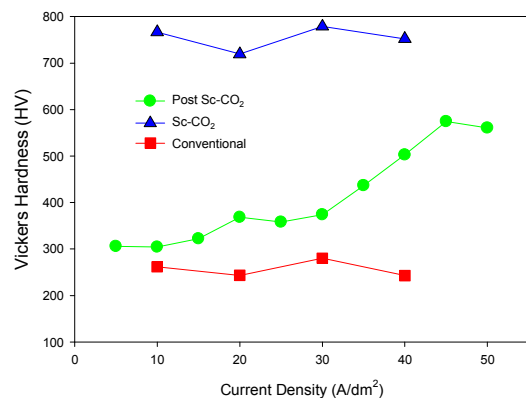

(a)

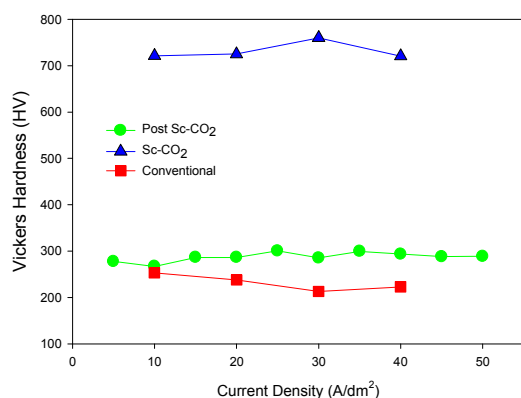

(b)

Fig. 5 Microhardness on cross section plane of nickel films plated in different methods and different current densities: (a) 20 μm , (b) 70 μm , from the substrate interface

The other important factor is that the presence of CO_2 bubbles in plating electrolyte raises the true current density, thus, overpotential [4]. The raise of electrolyte overpotential accelerates the metal reduction rate [15], thus, the electrodeposited grains would be also refined. Nevertheless, presence of gas bubbles in aqueous electrolyte play the role in improving mechanical properties of metal coating, not only in the supercritical condition. Therefore, in this work, the nano-sized grains and smooth surface that plated at a certain initial time period, probably account for the high hardness in post Sc- CO_2 plated nickel films.

Additionally, due to volume expansion of CO_2 during de-pressurization after the Sc- CO_2 mixing, the temperature of the electrolyte dropped from 50°C to 42°C. However, owing to the continuous heating of the water jacket surrounding the reaction chamber, the temperature was gradually returned to the controlled 50°C. The recovery in the electrolyte temperature somewhat contributes to the lowering of the hardness [9].

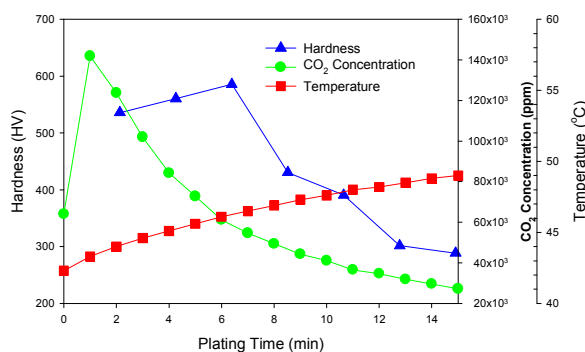

Fig. 6 The hardness of the coating, measured electrolyte temperature and CO_2 concentration associated with the elapsed plating time for the post Sc- CO_2 electroplating

V.CONCLUSION

A nickel electrodeposition process using the electrolyte post mixed with Sc- CO_2 and performing plating at atmospheric

pressure was investigated in this study. The results in this work indicated that the post Sc- CO_2 electroplating method would be able to achieve nano-sized nickel grains, thus, high hardness that was closed to, while still lower than, its pure Sc- CO_2 electrodeposit counterpart. Since the effect of the dissolved CO_2 in the electrolyte diminished with the elapsed time, the coating prepared with high current density could shorten the electrodeposition time and retain more Sc- CO_2 beneficial influences in hardness. On the other hand, the residue of dissolved CO_2 bubbles in Watts bath electrolyte was also found related to the grain refinement and surface smoothening of nickel electrodeposit. Moreover, the decrease in electrolyte temperature due to the quick de-pressurization after Sc- CO_2 mixing contributed to the increase in coating hardness. However, the influence CO_2 bubbles remained in electrolyte was predominant. The finding in this study revealed that a thin coating could be conveniently prepared by using post Sc- CO_2 method which although had lower hardness but contained less nano-pinholes than its Sc- CO_2 counterpart. When a much thicker coating was required, say several hundred μm , a device having continuous renewal of the plating bath with post Sc- CO_2 mixed electrolyte would be necessary.

ACKNOWLEDGMENT

The financial support from National Science Council, Taiwan under the Grant No. NSC 101-2221-E-027-026 is gratefully acknowledged.

REFERENCES

- [1] H. Yoshida, M. Sone, A. Mizushima, K. Abe, X.T. Tao, S. Ichihara, S. Miyata, Electroplating of nanostructured nickel in emulsion of supercritical carbon dioxide in electrolyte solution, *Chemistry Letters*, vol. 11, pp. 1086-1087, 2002.
- [2] T.F.M. Chang, M. Sone, A. Shibata, C. Ishiyama, Y. Higo, Bright nickel film deposited by supercritical carbon dioxide emulsion using additive-free Watts bath, *Electrochimica Acta*, vol. 55, pp. 6469-6475, 2010.
- [3] T.F.M. Chang, M. Sone, Function and mechanism of supercritical carbon dioxide emulsified electrolyte in nickel electroplating reaction, *Surface and Coatings Technology*, vol. 205, pp. 3890-3899, 2011.
- [4] S.T. Chung, H.C. Huang, S.J. Pan, W.T. Tsai, P.Y. Lee, C.H. Yang, M.B. Wu, Material characterization and corrosion performance of nickel electrodeposited in supercritical CO_2 fluid, *Corrosion Science*, vol. 50, pp. 2614-2619, 2008.
- [5] S.T. Chung, W.T. Tsai, Nanocrystalline Ni-C electrodeposits prepared in electrolytes containing supercritical carbon dioxide, *Journal of the Electrochemical Society*, vol. 156, pp. D457-D461, 2009.
- [6] N. Shinoda, T. Shimizu, T.F.M. Chang, A. Shibata, M. Sone, Filling of nanoscale holes with high aspect ratio by Cu electroplating using suspension of supercritical carbon dioxide in electrolyte with Cu particles, *Microelectronic Engineering*, vol. 97, pp. 126-129, 2012.
- [7] V.V. Dhanuka, J.L. Dickson, W. Ryoo, K.P. Johnston, High internal phase CO_2 -in-water emulsions stabilized with a branched nonionic hydrocarbon surfactant, *Journal of Colloid and Interface Science*, vol. 298, pp. 406-418, 2006.
- [8] V.C. Nguyen, C.Y. Lee, F.J. Chen, C.S. Lin, T.Y. Liu, Study on the internal stress of nickel coating electrodeposited in an electrolyte mixed with supercritical carbon dioxide, *Surface and Coatings Technology*, vol. 206, pp. 3201-3207, 2012.
- [9] V.C. Nguyen, C.Y. Lee, L. Chang, F.J. Chen, C.S. Lin, The relationship between nano crystallite structure and internal stress in Ni coatings electrodeposited by Watts bath electrolyte mixed with supercritical CO_2 , *Journal of the Electrochemical Society*, vol. 159, pp. D393-D399, 2012.
- [10] C.V. Nguyen, C.Y. Lee, F.J. Chen, C.S. Lin, L. Chang, An electroplating technique using the post supercritical carbon dioxide mixed electrolyte,

Surface & Coating Technology, in press, <http://dx.doi.org/10.1016/j.surfcoat.2013.05.016>, 2013.

- [11] J. Eigeldinger, H. Vogt, The bubble coverage of gas-evolving electrodes in a flowing electrolyte, *Electrochimica Acta*, vol. 45, pp. 4449-4456, 2000.
- [12] R. Weil, Origins of stress in electrodeposits- part I, *Plating*, vol. 57, pp. 1231-1237, 1970.
- [13] S.H. Kim, H.J. Sohn, Y.C. Joo, Y.W. Kim, T.H. Yim, H.Y. Lee, and T. Kang, Effect of saccharin addition on the microstructure of electrodeposited Fe-36 wt% Ni alloy, *Surface and Coating Technology*, vol. 199, pp. 43-48, 2005.
- [14] C.V. Thompson, Structure evolution during processing of polycrystalline films, *Annual Review of Materials Science*, vol. 30, pp. 159-190, 2000.
- [15] J.K. Dennis, and T.E. Such, *Nickel and Chromium Plating*, Wiley, 1972.