

Gas Turbine Optimal PID Tuning by Genetic Algorithm using MSE

R. Oonsivilai and A. Oonsivilai

Abstract—Realistic systems generally are systems with various inputs and outputs also known as Multiple Input Multiple Output (MIMO). Such systems usually prove to be complex and difficult to model and control purposes. Therefore, decomposition was used to separate individual inputs and outputs. A PID is assigned to each individual pair to regulate desired settling time. Suitable parameters of PIDs obtained from Genetic Algorithm (GA), using Mean of Squared Error (MSE) objective function.

Keywords—Gas Turbine, PID, Genetic Algorithm, Transfer function, Mean of Squared Error

I. INTRODUCTION

IN electricity generation, an electric generator is a device that converts mechanical energy to electrical energy. A generator forces electric charge (usually carried by electrons) to flow through an external electrical circuit. It is analogous to a water pump, which causes water to flow (but does not create water). The source of mechanical energy may be a reciprocating or turbine steam engine, water falling through a turbine or waterwheel, an internal combustion engine, a wind turbine, a hand crank, compressed air or any other source of mechanical energy. Early 20th century alternator made in Budapest, Hungary, in the power generating hall of a hydroelectric station. The reverse conversion of electrical energy into mechanical energy is done by an electric motor, and motors and generators have many similarities. In fact many motors can be mechanically driven to generate electricity, and very frequently make acceptable generators.

A. Gas Turbine Engine

A next generation tank engine currently under development at GE, is presented in schematic form in Figure 1. Key features to note from this figure include the two engine spools connected to the turbines and the recuperator inserted in the airflow path. The high pressure turbine couples to the vehicle transmission. The recuperator improves thermodynamic efficiency. From a controls point of view, the objective is to vary main fuel flow (W_f) and the variable area turbine nozzle (V_{ATN}) to regulate the speeds of the gas generator spool (N_g)

R.Oonsivilai is with the School of Food Technology, Center of Excellence in Electric Energy, Smart Materials, and Health Science, Institute of Agricultural Technology, Suranaree University of Technology, NakhonRatchasima, 30000 Thailand (phone: 66-442-24232; fax: 66-442-24232; e-mail: roonsivi@sut.ac.th).

*A. Oonsivilai, corresponding author, is with Center of Excellence in Electric Energy, Smart Materials, and Health Science, Postharvest Technology Research Center, School of Electrical Engineering, Institute of Engineering, Suranaree University of Technology, NakhonRatchasima, 30000 Thailand. (e-mail: anant@sut.ac.th).

and the power output to the vehicle (N_p) while ensuring that internal constraints on temperatures and stall margins are not violated. [1] The widely popular use of PID controllers in the process control and instrumentation of industry because of its straight forward structure which can be simply implemented and established in a wide range of operating condition with robust performance. Although it has simple structure but it also has been hardly setup to PID controller parameters properly. The classical tuning rules proposed by Ziegler and Nichols are often difficult to find optimal PID parameters.

Many artificial intelligence (AI) techniques have been vitalized to re-association basic characteristics of controller to improve the controller performance by adding new feature or new criterion. Proper tuning PID controller parameters is using AI techniques for instance fuzzy logic system, neural network, and neural-fuzzy logic system [3-6]. Not only proper tuning PID but also optimum tuning PID has been applied by many random search methods such as genetic algorithm (GA), simulated annealing (SA) and evolutionary computational techniques (EC).

This paper focuses on optimal tuning of PID controller for the gas turbine machine using genetic algorithm (GA). GA is one of the modern heuristic algorithms. Many performance estimation schemes are performed by genetic algorithm to obtain the optimum PID controller parameters of turbine machine. The proposed method gave excellence performance in working out the optimal PID controller parameters.

II. GENETIC ALGORITHMS

Genetic Algorithms (GAs) is computationally simple and independent of any assumption about search space. Moreover, they are stochastic parallel global-search algorithms based on the mechanism of natural genetics and the biological theory of evolution. GAs simultaneously evaluates many points in the parameter space, so they are more likely to converge toward a global solution. GAs is very suitable for searching discrete, noisy, multimodal and complex space.

GAs differs from other search or optimization algorithms. First, the algorithms work with a coding of the parameter set, not the parameters themselves. Binary coding is normally used and has been suggested to be optimal in certain cases. Secondly, the algorithms search from the population of points, climbing many peaks in parallel, and therefore have a reduced chance of converging to optima. Thirdly, the algorithms only require object function values to guide their search, but they have no need for derivative or other auxiliary information. Finally, the algorithms use probabilistic rather than deterministic transition rules to guide their search. Thus, these differences contributed to a genetic algorithms' robustness and resulting advantage over other more commonly used techniques [2,8-9].

When GAs is applied to solve the parallel problem, the natural parameter set of the problem needs to be coded as a finite length string (an individual). The set of all the strings is known as the population. Each string presents one possible solution to the problem. GAs begins by randomly generating an initial population of strings. Then this population evolves from generation to generation through the application of genetic operators, which imitates genetic processes occurring in nature. In every generation, all strings of the population are evacuated according to their fitness value. A simple GA is composed of three operators: reproduction, crossover, and mutation. Reproduction is based on the principle of survival of the fittest. It is processes by which strings are copied according to their fitness with greater fitness receive one or more copied, in the new population, and those with low fitness may have none. The systematic information exchange utilizing probabilistic decisions is implemented by crossover. To applying this operator, two strings are selected from the reproduced population to produce new offspring by exchanging portions of their structure. The offspring may replace weaker individuals in the population. Crossover is responsible for producing new trial solutions. Mutation is a local operator, which is applied with a very low probability of occurrence. It is the occasional random alteration of a string position to produce a new structure, which provides insurance against the permanent loss of any simple bit.

GAs efficiently exploit past information to explore new regions of the decision space with a high probability of finding improved performance, and are theoretically and empirically proven to provide robust searches in complex spaces [2,8-9].

The main features of the GA are:

1) Parameters encoding

Gene on chromosomes is composed as binary bit unit and are expressed as the binary string of limited M and the population length. Initially, this generates length with string N.

2) Fitness Evaluation

GA needs fitness for superior population formation. It can be possible with the help of the evaluation of excellence and worthlessness among strings, mainly; it is calculated from objective function. The fitness evaluation is performed every generation for each string and the results of the fitness evaluation become important information for reproduction, crossover, mutation, etc.

3) Reproduction

Reproduction operator performs the modeling of the natural selection phenomenon, adapted string is survived, otherwise is disused. That is, the strings with high fitness increase in reproduced probability at next generation. In general, a roulette wheel selection method is used.

4) Crossover

In an ecosystem, chromosomes occur the phenomenon of exchanging some genes. This phenomenon is designated also that the crossover. This is an important phenomenon string with the chromosomes of finite numbers obtain genetic variation. In general, the probability raising crossover between

two strings is from 0.6 to 0.95. In search course, the genetic search method has merits because it can obtain the global performance superior to parents through local action among chromosomes. Crossover carries out the core role in GA.

5) Mutation

Mutation is phenomenon making new traits by the sudden form change of genes. Mutation is also an important factor as crossover. In general, GA is possible to the global shift as well as the local search by mutation. The mutation probability should be selected from 0.001 to 0.01 because rises regardless of adaptation of environment mutation randomly. If the mutation probability is very high, it can lose important traits. Therefore, it must be selected properly. Finally, the flowchart of GAs is shown in Fig. 3 [2,8-9].

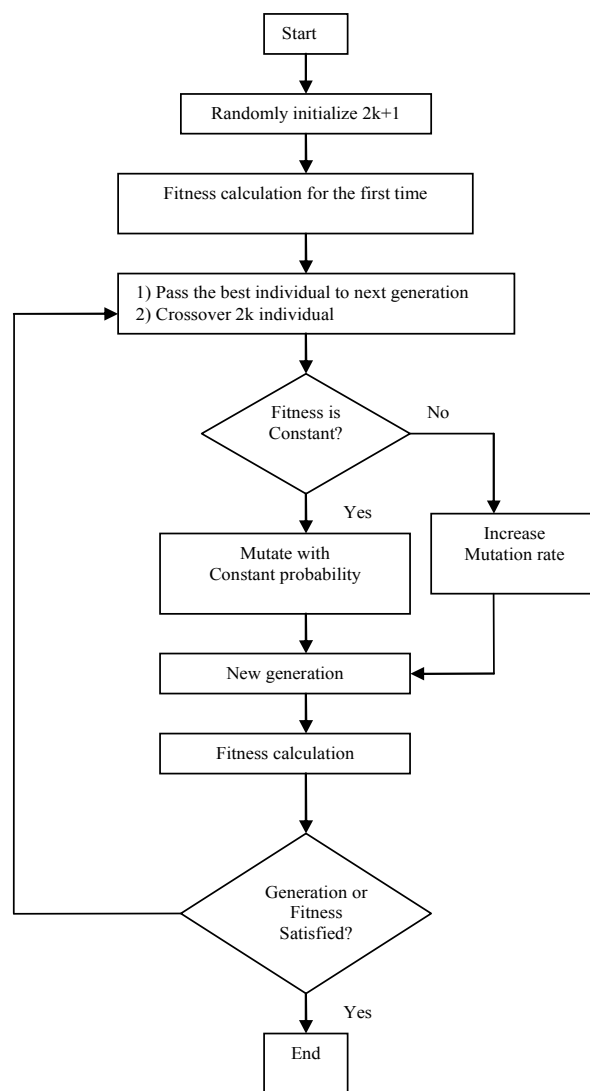

Fig. 1 Flowchart of Genetic Algorithms [10]

III. MATHEMATICAL MODELS

In this model, connected to the turbines are two engine spools, in the airflow path a recuperator is inserted to improve thermodynamic efficiency. Low pressure turbines are coupled

to the vehicle transmission, while high pressure turbines are used to drive the compressors [1].

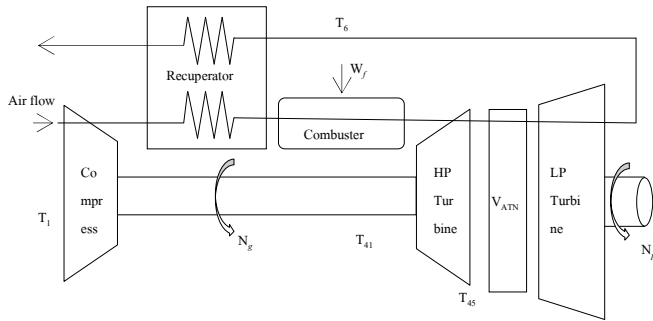

Fig. 2 Gas turbine engine schematic diagram (LV100)

In practical usage, the issue is one of controlling; main fuel flow (W_f), output power to the vehicle (N_p) and turbine nozzle area (V_{ATN}) to regulate gas generator spool speed (N_g), to requirement while abiding by internal constraints on temperatures and stall margins [1].

The system has two inputs, two outputs and consists of five states.

$$\dot{x} = Ax + Bu \quad (1)$$

$$y = Cx + Du \quad (2)$$

$u = [W_f \ V_{ATN}]'$ as the input, $y = [N_g \ T_6]'$ as the output.

$$A = \begin{bmatrix} -1.4122 & -0.0552 & 0 & 42.9536 & 6.3087 \\ 0.0927 & -0.1133 & 0 & 4.2204 & -0.7581 \\ -7.8467 & -0.2555 & -3.3333 & 300.4167 & -4.4894 \\ 0 & 0 & 0 & -25.0000 & 0 \\ 0 & 0 & 0 & 0 & -33.3333 \end{bmatrix},$$

$$B = \begin{bmatrix} 0 & 0 \\ 0 & 0 \\ 0 & 0 \\ 1 & 0 \\ 0 & 1 \end{bmatrix}$$

$$C = \begin{bmatrix} 1 & 0 & 0 & 0 & 0 \\ 0 & 0 & 1 & 0 & 0 \end{bmatrix}, \quad D = \begin{bmatrix} 0 & 0 \\ 0 & 0 \end{bmatrix}$$

Whereas; x_{wf} is the state associated with actuation of $x_{V_{ATN}}$ is the state associated with the actuation of From a normalized space representation with the state vector

$$x = [N_g \ N_p \ T_6 \ x_{wf} \ x_{V_{ATN}}]'$$

Then the continuous-time transfer function model for the gas turbine is.

$$\begin{bmatrix} y_1 \\ y_2 \end{bmatrix} = \begin{bmatrix} G_{11} & G_{12} \\ G_{21} & G_{22} \end{bmatrix} \begin{bmatrix} u_1 \\ u_2 \end{bmatrix}$$

$$G_{11} = \frac{42.95s + 4.634}{s^3 + 26.53s^2 + 38.3s + 4.128},$$

$$G_{12} = \frac{300.4s^2 + 120.2s - 10.71}{s^4 + 29.86s^3 + 126.7s^2 + 131.8s + 13.76},$$

$$G_{21} = \frac{6.309s + 0.7566}{s^3 + 34.86s^2 + 51.02s + 5.504},$$

$$G_{22} = \frac{-4.489s^2 - 56.16s - 6.554}{s^4 + 38.19s^3 + 167.2s^2 + 175.6s + 18.35}. \quad (3)$$

IV. EVALUATE THE PROCESS USING FITNESS FUNCTION

A. Objective function

The most crucial step in applying GA is to choose the objective functions that are used to evaluate fitness of each chromosome. Some works use performance indices as the objective functions. The objective functions are Mean of the Squared Error (MSE) as the following:

$$MSE = \frac{1}{t} \int_0^t (e(t))^2 dt \quad (4)$$

B. The fitness values

The PID controller is used to minimize the error signals, or can be defined more rigorously, in the term of error criteria: to minimize the value of performance indices mentioned above. And because the smaller the value of performance indices of the corresponding chromosomes the fitter the chromosomes will be, and vice versa, define the fitness of the chromosomes as [1]:

$$Fitness\ Value = \frac{1}{Performance\ Index} \quad (5)$$

V. PROPOSED NEW METHOD

This paper presents an advanced auto tuning PID controller for RO plant to search the optimal control gain parameters, with improved GA. The searching steps of the proposed optimal PID controller are shown as below. The improved GA has new random generator and objective.

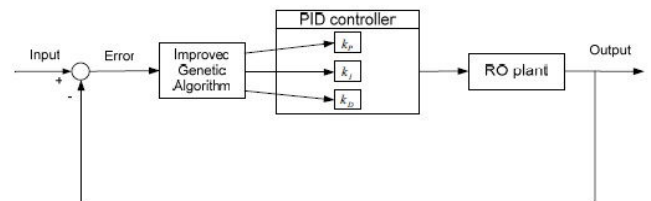

Fig. 3 Schematic of auto tuning PID controller based on improved GA function [1]

VI. SIMULATION RESULTS

The parameters describe by following are setting for the Genetic Algorithms used in this paper.

GA:

Number of population = 80

Crossover = 4
 Mutation = 8

Variable : PID₁ Range
 $K_p: [0, 100]; K_i: [0, 100]; K_d: [0, 100]$

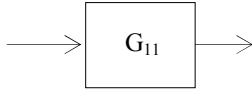

Fig. 4 Open-loop control system G_{11} with W_f input and N_g output.

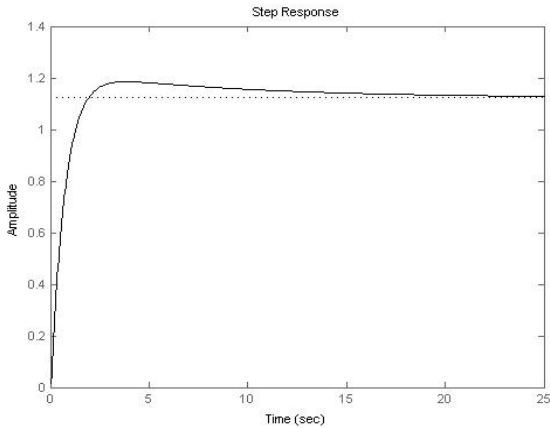

Fig. 5 Step response characteristics of open-loop control system G_{11} with W_f input and N_g output

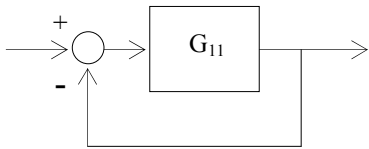

Fig. 6 Closed-loop control system G_{11} with W_f input and N_g output

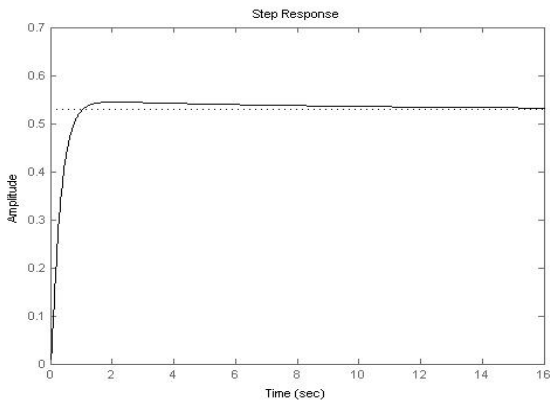

Fig. 7 Step response characteristics of closed-loop system G_{11} with W_f input and N_g output.

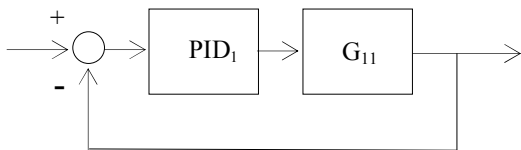

Fig. 8 Closed-loop with PID₁ control G_{11} system with W_f input and N_g output

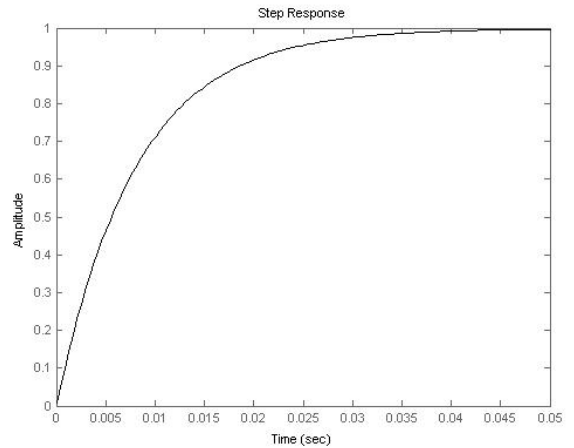

Fig. 9 Step response characteristics of the closed-loop system G_{11} applying Genetic Algorithms with by MSE W_f input and N_g output

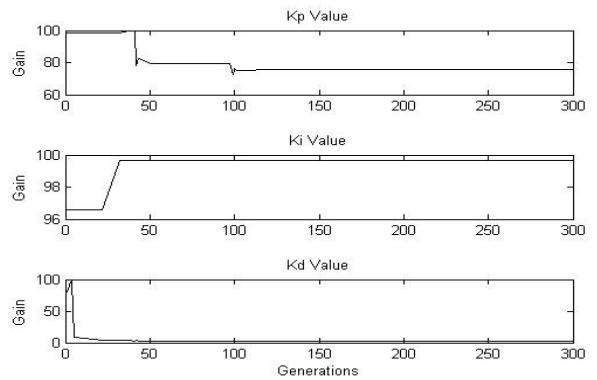

Fig. 10 Number of generation of K_p, K_i, K_d value of PID₁
 Variable : PID₂ Range
 $K_p: [0, 100]; K_i: [0, 200]; K_d: [0, 100]$

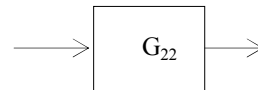

Fig. 11 Open-loop control system G_{22} with V_{ATN} input and T_6 output

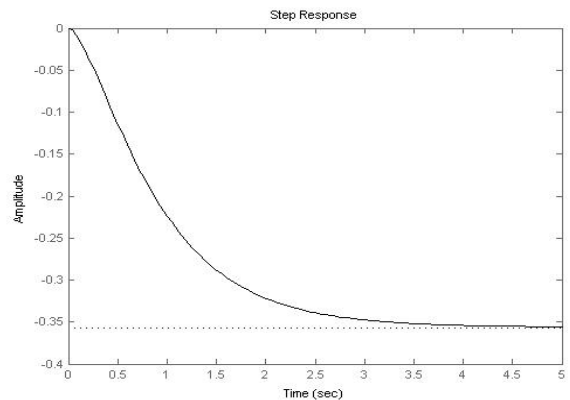

Fig. 12 Step response characteristics of Open-loop control system G_{22} with V_{ATN} input and T_6 output

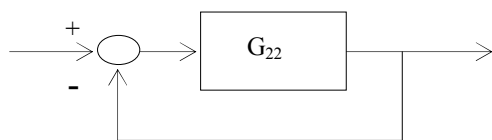

Fig. 13 Closed-loop control system G_{22} with V_{ATN} input and T_6 output

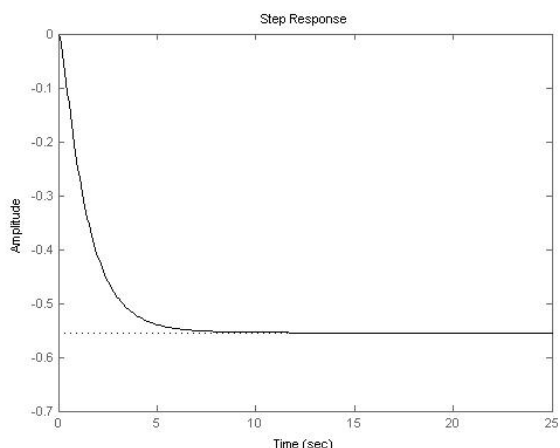

Fig. 14 Step response characteristics of closed-loop control G_{22} system applying Genetic Algorithms with by MSE with V_{ATN} input and T_6 output

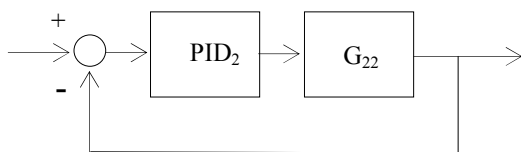

Fig. 15 Closed-loop with PID_2 control system G_{22} with V_{ATN} input and T_6 output

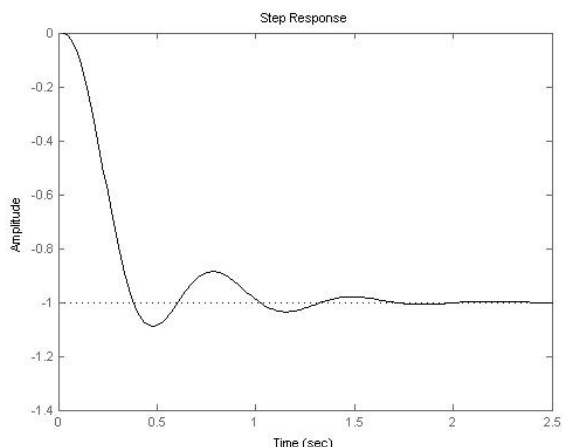

Fig. 16 Step response characteristics of closed-loop with PID_2 control system G_{22} with with V_{ATN} input and T_6 output

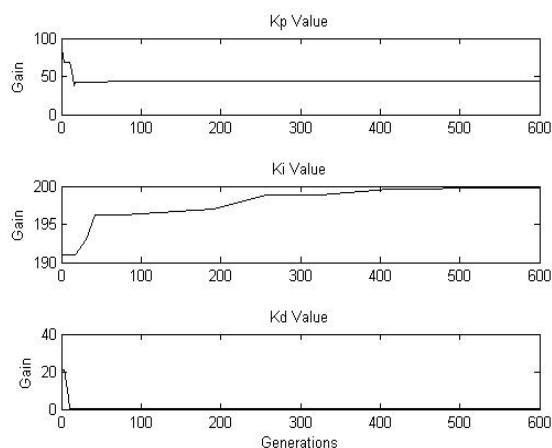

Fig. 17 Number of generation of K_p , K_i , K_d value of PID_2

As demonstrated, the results simulated by using the parameters obtained from the Genetic Algorithms are reasonable when applying in PID tuning for gas turbine machine.

VII. CONCLUSION

In this paper, the application of genetic algorithm for finding the optimum K_p , K_i , K_d values for PID_1 and PID_2 tuning using MSE objective function was proposed. Simulation results were satisfactory. After using PID to tune under optimisation technique, over shoot and settling time has significantly decreased.

ACKNOWLEDGMENT

This research was supported by Research and Development Institute Funds, Suranaree University of Technology, Nakhon Ratchasima, Thailand.

REFERENCES

- [1] Potvin, A. F. 1991. A unified solution to constrained configuration control law design. MSc. Thesis. Department of electrical engineering and computer science, Massachusetts Institute of Technology.
- [2] P. Pao-La-Or, T. Kulworawanichpong, and A.Oonsivilai, 2007. Frequency domain parameter estimation of a synchronous generator using bi-objective genetic algorithms. WSEAS Sep 15-17, Beijing, China.
- [3] J.S. Kim, J.H. Kim, J.M. Park, S.M. Park, W.Y. Choe and H. Heo, 2008. Auto tuning PID controller based on improved genetic algorithm for reverse osmosis plant, World Academy of Science, Engineering and Technology vol.47
- [4] A. Oonsivilai, and M.Boonruang,. Optimal PID Tuning for AGC system using Adaptive Tabu Search. WSEAS Sep 15-17, Beijing, China.
- [5] K. Somsai, A. Oonsivilai, A. Srikaew, and T. Kulworawanichpong, 2007. Optimal PI controller design and simulation of a static var compensator using MATLAB's SIMULINK. WSEAS Sep 15-17, Beijing, China
- [6] Oonsivilai, R. Chaijareonudomrourng, N., Huantanom, Y., and Oonsivilai, A. 2010. Extraction condition of *Echinocactus grusonii*. ICCBEE 2010: International Conference on Chemical, Biological and Environmental Engineering, World Academy of Science, Engineering and Technology, Paris, France, 27-29 October, pp: 366: 369.
- [7] Oonsivilai, R. and Oonsivilai, A. 2010. Differential evolution application in temperature profile of fermenting. WSEAS

TRANSACTION on SYSTEMS. Issue. ISSN: 1109-2777. Issue 6(9): 618-628.

- [8] Oonsivilai, A. and Oonsivilai, R. 2009. A genetic algorithm application in natural cheese products. WSEAS TRANSACTIONS on SYSTEMS. Issue 1, Vol 8, January, ISSN : 1109 – 2777, pp: 44 – 54.
- [9] Oonsivilai, A. and Oonsivilai, R. 2008. Parameter Estimation of Frequency Response Twin-Screw Food Extrusion Process using Genetic Algorithm. WSEAS TRANSACTIONS on SYSTEMS. Issue 7 Volume 7, July, ISSN: 1109 – 2777