



## **DELIVERABLE REPORT**

---

**WP3** Conceiving and prototyping the e-SAFE technologies

**D3.5**

# **CERTIFICATES OF SUCCESSFUL TESTING**

Due date

**M24 30.09.2022**

LEGAL NOTICE: The sole responsibility for the content of this publication lies with the authors. It does not necessarily reflect the opinion of the European Union.

Neither Innovation and Networks Executive Agency (INEA) nor the European Commission is responsible for any use that may be made of the information contained therein.

PROPRIETARY RIGHTS STATEMENT: This document contains information, which is proprietary to the e-SAFE Consortium. Neither this document nor the information contained herein shall be used, duplicated or communicated by any means to any third party, in whole or in parts, except with prior written consent of the e-SAFE Consortium.



## PROJECT DETAILS

PROJECT ACRONYM

e-SAFE

PROJECT TITLE

Energy and Seismic Affordable rEnovation solutions

GRANT AGREEMENT NO:

893135

FUNDING SCHEME

H2020-EU.3.3.1. - Reducing energy consumption and carbon footprint by smart and sustainable use. LC-SC3-EE-1-2018-2019-2020 - Decarbonisation of the EU building stock: innovative approaches and affordable solutions changing the market for buildings renovation

START DATE

01.10.2020

## WORK PACKAGE DETAILS

WORK PACKAGE ID

WP3

WORK PACKAGE TITLE

Conceiving and prototyping the e-SAFE technologies

WORK PACKAGE LEADER

UNIBO

## DELIVERABLE DETAILS

DELIVERABLE ID

D3.5

DELIVERABLE TITLE

Certificates of successful testing

DUE DATE

M48 30.09.2022

ACTUAL SUBMISSION DATE

15.11.2022

LEAD PARTNER

WEBO

CONTRIBUTING PARTNER(S)

UNICT, UNIBO, NMBU, PINK

LEAD AUTHOR(S)

Christian HALMDIENST (PINK), Bart VOORTMAN and Manon JANSEN (WEBO)

DISSEMINATION LEVEL

- P - Public
- PP - Restricted to other programme participants & EC: (Specify)
- RE - Restricted to a group (Specify)
- CO - Confidential, only for members of the consortium

TYPE

- R - Report
- DEM - Demonstrator
- DEC Websites, patents filling, videos, etc.
- OTHER
- ETHICS – Ethics requirement
- OPRP - Open Research Data Pilot
- DATA – Data sets, microdata, etc.

## REPORT DETAILS

ACTUAL SUBMISSION DATE	NUMBER OF PAGES
15.11.2022	34
VERSION	FILE NAME
1.0	e-SAFE_D3.5_Certificates of successful testing_V1.0.docx

## DOCUMENT HISTORY

VER.	DATE	DESCRIPTION AND FILE NAME	AUTHOR(S) NAME
0.1	20.09.2022	Creation of the document e-SAFE_D3.5_Certificates of successful testing_V0.1.docx	Bart VOORTMAN, Manon JANSEN (WEBO)
0.2	31.10.2022	Adaptation after first peer review e-SAFE_D3.5_Certificates of successful testing_V0.2.docx	Christian HALMDIENST (PINK), Bart VOORTMAN and Manon JANSEN (WEBO)
0.3	10.11.2022	Adaptation after second peer review e-SAFE_D3.5_Certificates of successful testing_V0.3.docx	Christian HALMDIENST (PINK), Bart VOORTMAN and Manon JANSEN (WEBO)
0.4	10.11.2022	Further review by the TM e-SAFE_D3.5_Certificates of successful testing_V0.4.docx	Gianpiero EVOLA (UNICT)
0.5	11.11.2022	Further review by the PC e-SAFE_D3.5_Certificates of successful testing_V0.5.docx	Giuseppe MARGANI (UNICT)
1.0	15.11.2022	Submitted version e-SAFE_D3.5_Certificates of successful testing_V1.0.docx	Giuseppe MARGANI (UNICT)

## DOCUMENT APPROVAL

VER.	NAME	POSITION IN THE PROJECT	BENEFICIARY	DATE	VISA
1.0	Giuseppe MARGANI	Project Coordinator (PC)	UNICT	15.11.2022	GM
1.0	Gianpiero EVOLA	Technical Manager (TM)	UNICT	15.11.2022	GE

# CONTENTS

Executive Summary	5
1. Introduction	6
1.1 Intended Audience	6
1.2 Relation to other activities	6
1.3 Document overview	6
2. e-Panel and e-CLT main functionalities	7
2.1 Technical details for e-PANEL and e-CLT	7
2.2 Views and 3D design for e-PANEL and e-CLT	10
2.3 Materials used for e-PANEL and e-CLT	11
2.4 Building the testing model for e-PANEL and e-CLT	12
2.5 Lessons learned during design and production	17
3. Design and production of e-TANK	18
4. Testing results on Prototypes	27
4.1 Testing of e-CLT and e-PANEL	27
4.2 Testing of e-TANK	28
5. Conclusions	32
References	33
Internal references	33
External references	33
Acknowledgements	34

## EXECUTIVE SUMMARY

This report gives an overview of the prototyping process of the **e-SAFE** technologies (in a mock-up form), while also presenting the results from testing and certification activities. The **e-SAFE** technologies that are presented in this report are **e-TANK**, **e-PANEL** and **e-CLT**.

For these technologies intensive design process was carried out, whose main results are reported in Deliverable D3.3 "Design of the e-SAFE technologies" [1]. In some case, an integrated design was necessary, as for **e-PANEL** and **e-CLT**. The design process was carried out by European **e-SAFE** members from different GEO clusters, e.g. Austria, Italy and the Netherlands. This combination of experiences from different building environment and cultures has impacted the design phase. Main lessons learnt in the design phase of **e-CLT** and **e-PANEL** are: 1) integrating knowledge from different geo-clusters is a time-consuming process; 2) complex design reflects in engineering time and production time.

Regarding the testing of the **e-PANEL** and **e-CLT** under NEN-EN-ISO/IEC 17025 [2], these tests were carried out successfully by testing body SHR in Wageningen (NL). The new innovative **e-SAFE** solutions proved to be a success and delivered a positive result during testing of both watertightness and fatigue.

In terms of airtightness, the measured air loss was 2.48 m<sup>3</sup>/h per m<sup>2</sup> at 100 Pa and 11.35 m<sup>3</sup>/h per m<sup>2</sup> at 600 Pa, which under NEN-EN 12207 [3] means the **e-SAFE e-PANEL** and **e-CLT** achieved Class 3.

In terms of water-tightness, the **e-PANEL** and **e-CLT** achieved an impressive level of 600 Pa of water-tightness, which under NEN-EN 12208 [4] means the **e-PANEL** and **e-CLT** solutions achieve Class 9A.

In terms of fatigue, the strength of the panels was tested with pressure of +2400/-2400 Pa. The elements withstood these very high pressures and under NEN-EN 12210 [5] they achieved Class 4.

Finally, the **e-TANK** solution was produced in Austria and tested for energy labels under EU Regulation 812/2013 [6]. Different measurements where performed, whose outcomes quantified the stand-by losses as 920 Wh/day. Under EU Regulation 812/2013, this level of performance translates into an energy label of A.

At the end of the project, a final round of prototyping and certification will be possibly performed in case of important modifications and improvements to the components design, based on the lessons learnt in the demonstration activities.

# 1. INTRODUCTION

This is the accompanying report of Deliverable D3.5, i.e. the reporting on the prototyping and testing/certifying activities for the **e-SAFE** technical solutions.

## 1.1 Intended Audience

---

The intended audience of the report is primarily represented by the members of the project's consortium, and the European Commission representatives tasked with reviewing the project and its progress towards meeting the specified milestones. Moreover, the report contains relevant information on the design and testing of the **e-SAFE** prototypes **e-PANEL**, **e-CLT** and **e-TANK**.

## 1.2 Relation to other activities

---

This document is related to Task 3.3 "Designing the **e-SAFE** components", and Task 3.4 "BIM-based abacus of solutions". Moreover, the completion of this report allows attaining Milestone MS7: "**e-SAFE** components tested and certified".

## 1.3 Document overview

---

The report is structured as follows:

- Section 2 provides the main functionalities of **e-PANEL** and **e-CLT**;
- Section 3 provides the main functionalities of **e-TANK**;
- Section 4 provides an overview of the results from testing the prototypes;
- In the conclusion (Section 5), the main technical results are summarized.

## 2. e-PANEL and e-CLT main functionalities

This section provides a recap of the main functionalities and design of the prototypes that are developed in the **e-SAFE** project. Next to that it gives an insight into the production process of some of the **e-SAFE** technologies.

### 2.1 Technical details for e-PANEL and e-CLT

In this paragraph we aim to give an overview of the design of the **e-PANEL** and **e-CLT** through the technical details that were developed by the WEBO team in collaboration with the team of the University of Catania. The details, pictured in Figure 1 through Figure 3, show cross-sections of the design, where the different materials, components and sizes are shown. In Figure 1 the buildup of the panel including the ceramic tiles can be seen.

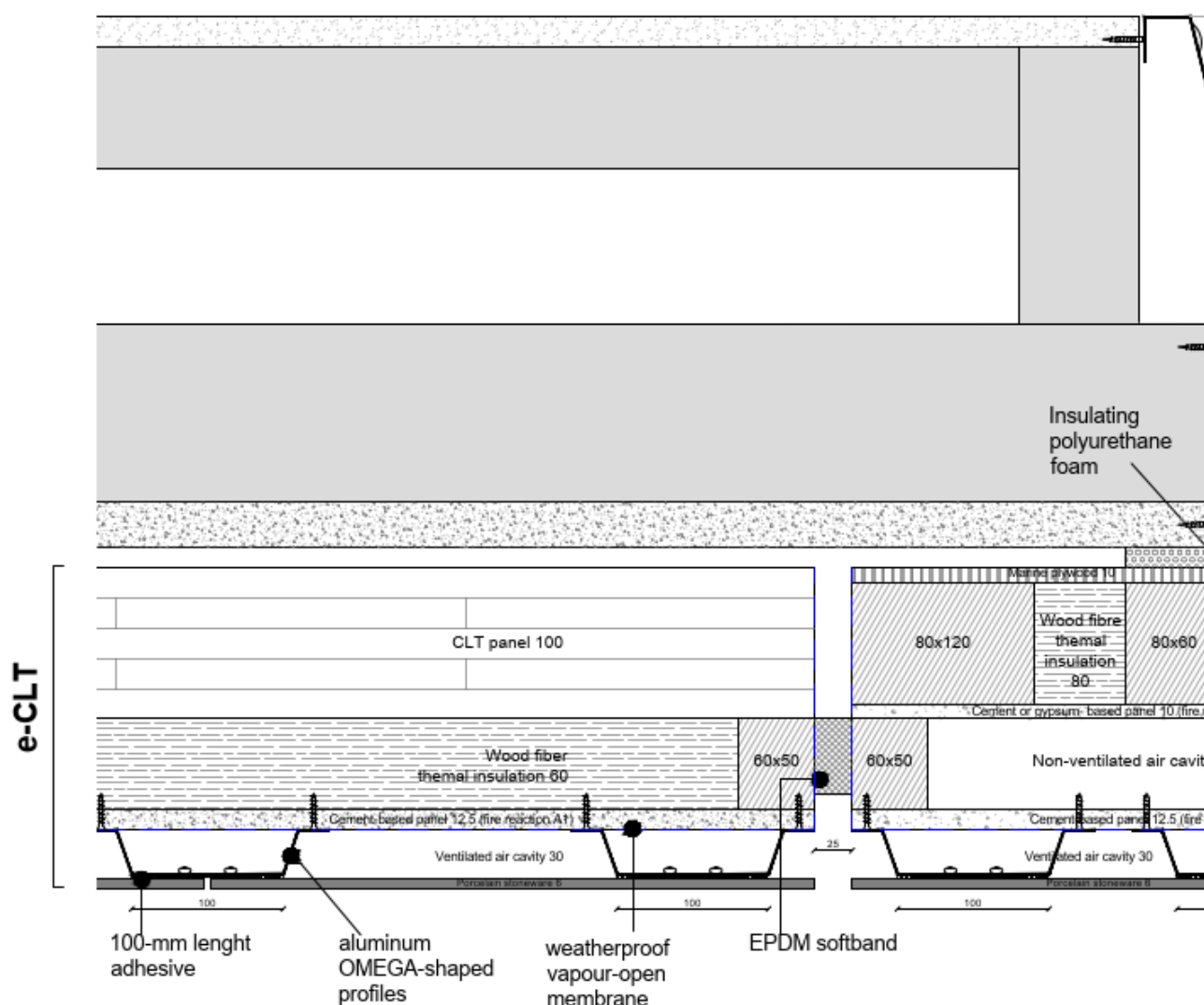

Figure 1: e-CLT and e-PANEL horizontal section (not to scale)

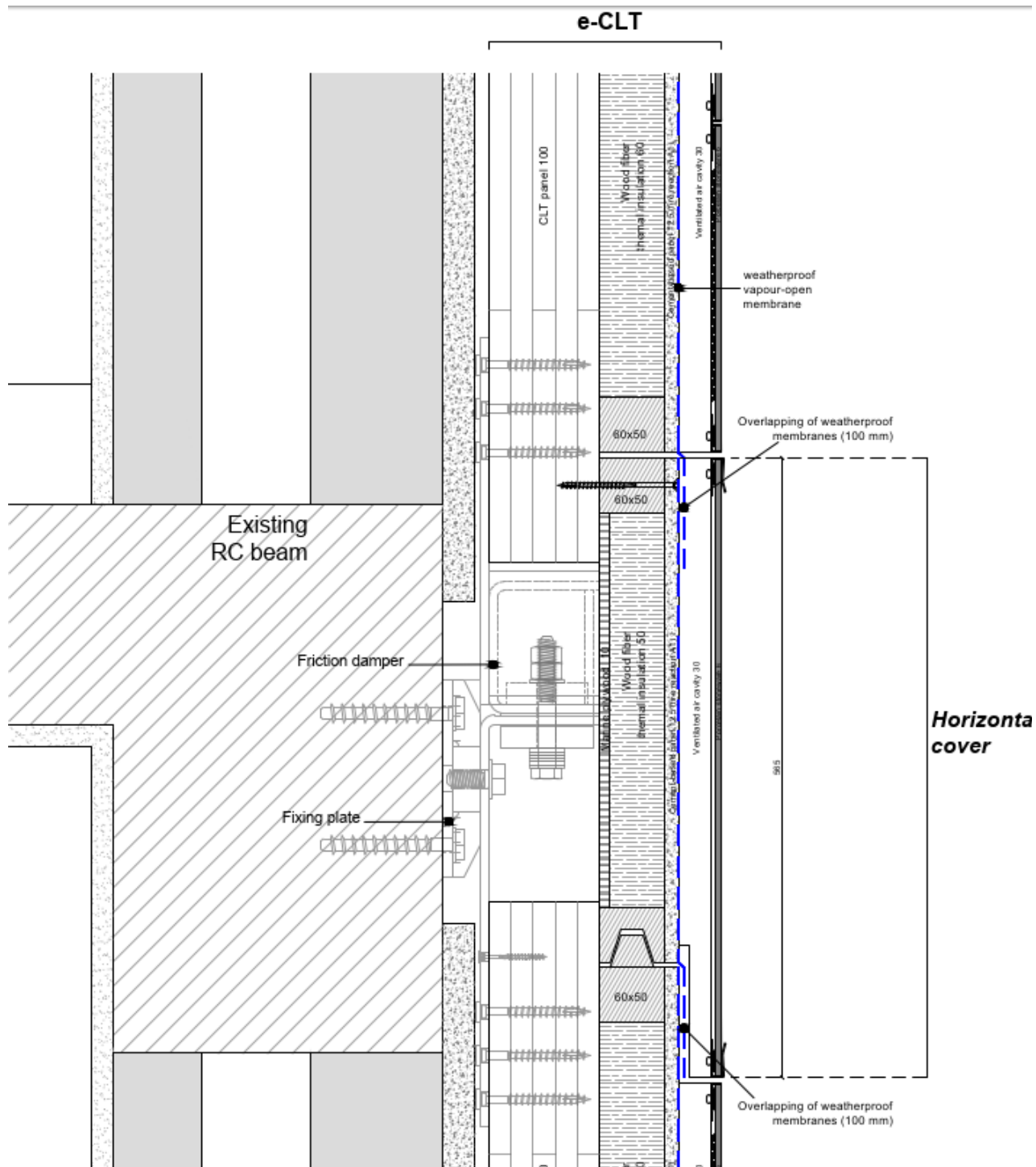

Figure 2: e-CLT vertical section (not to scale)

In Figure 2 the vertical cross section of the **e-CLT** technology is shown, including the horizontal cover needed to protect and insulate the friction damper. Insulation is completely in line throughout the **e-PANEL**, cover and **e-CLT**.



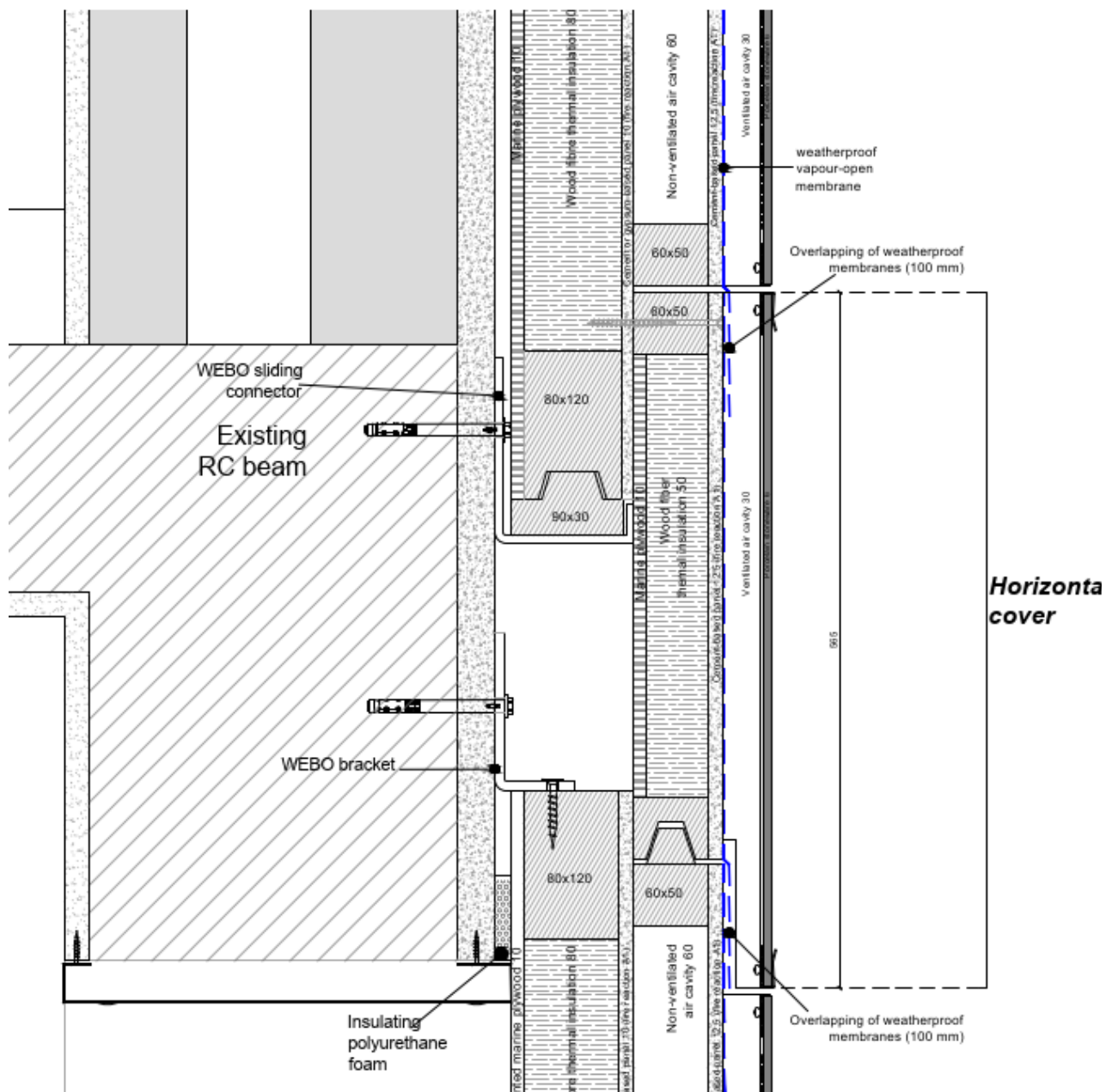

Figure 3: e-PANEL vertical section (not to scale)

In Figure 3, the horizontal cover is shown in the case of the e-PANEL anchors, based on the already existing WEBO anchor system.

## 2.2 Views and 3D design for e-PANEL and e-CLT

In this paragraph, we aim to show the mock-up of the **e-CLT** and **e-PANEL** in the 3D design in order to give some visual representation of the final design. These visualizations can help taking design decisions on aesthetics and give a depth of feel for the design team. Figures 4 through Figure 6 are outputs from the 3D model that is created in the design of the **e-PANEL** and **e-CLT**. In Figure 4, the front Marazzi tiles can be seen. These tiles are the same brand that will be used in the real pilot in Catania. The design also shows the seams and the pattern that can be expected on situations where **e-CLT** and **e-PANEL** meet in the real pilot. In Figure 5 the back of the **e-CLT** on the right and the back of the **e-PANEL** on the left can be seen as well.

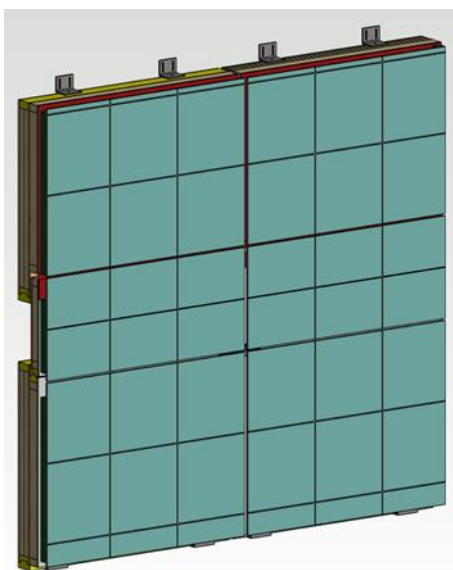

Figure 4: 3D front view of the e-SAFE facade

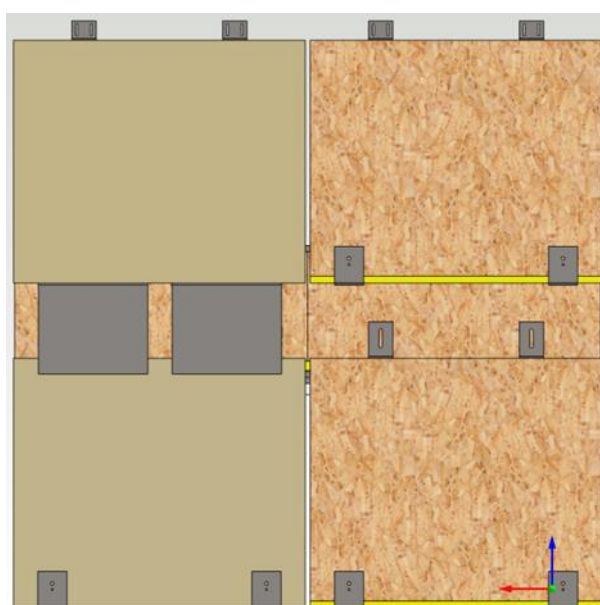

Figure 5: Left - front view of the tiles. Right - back view of the panels

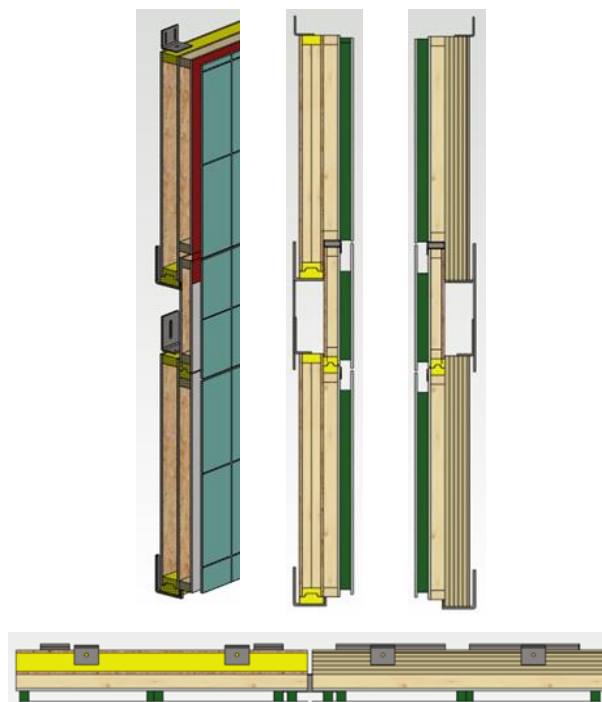

Figure 6: 3D side views, top view and cross section of the panels

## 2.3 Materials used for e-PANEL and e-CLT

This paragraph aims to give an overview of all the materials used for the production of **e-CLT** and **e-PANEL**. This bill of materials is useful for future reference when this mock-up design is transferred into the real-life pilot project that is planned in Italy. A bill of material can be useful also for future use in an environmental study of the **e-SAFE** design. The entire façade will be cladded with **e-CLT**, **e-PANEL** and the middle panel, i.e. the cover.

1. Materials from inside to outside **e-CLT** panels:
  - CLT glued underlayment (5 x 18 mm + 1 x 9 mm)
  - wood fiber thermal insulation between wooden batten 60 x 50 mm (60 mm)
  - Bluclad plate fire resistance A1 (18 mm)
  - weatherproof membranes
  - ventilated air cavity
  - aluminum profiles, attached to the Bluclad plates with self-drilling screws
  - ceramic tiles glued
  
2. Materials from inside to outside middle panel/cover:
  - underlayment (18 mm)
  - wood fiber thermal insulation between wooden batten 60 x 50 mm (60 mm)
  - Bluclad plate fire resistance A1 (18 mm)
  - weatherproof membranes
  - ventilated air cavity
  - aluminum profiles, attached to the Bluclad plates with self-drilling screws
  - ceramic tiles glued
  
3. Materials from inside to outside **e-PANELS**:
  - underlayment (18 mm)

- wood fiber thermal insulation between wooden batten 80 x 120 mm (80 mm)
  - underlayment (18 mm)
  - wood fiber thermal insulation between wooden batten 60 x 50 mm (60 mm)
  - Bluclad plate fire resistance A1 (18 mm)
  - weatherproof membranes
  - ventilated air cavity
  - aluminum profiles, attached to the Bluclad plates with self-drilling screws
  - ceramic tiles glued
4. Air and waterproofing between the panels:
- EPDM soft band
  - Lead drip trays

## 2.4 Building the testing model for e-PANEL and e-CLT

This paragraph aims to give an overview of the production process that follows after the design process discussed in the previous paragraphs. In Figures 8 through 16 the production of the e-SAFE solutions e-PANEL and e-CLT are displayed through pictures taken during the production process. Each step is mentioned in the Figure captions, the production steps being presented in chronological order. Figure 7 shows the small 3D mock-up elements, which are two pieces that are made in the WEBO facilities for educational and promotional purposes for the e-SAFE project.

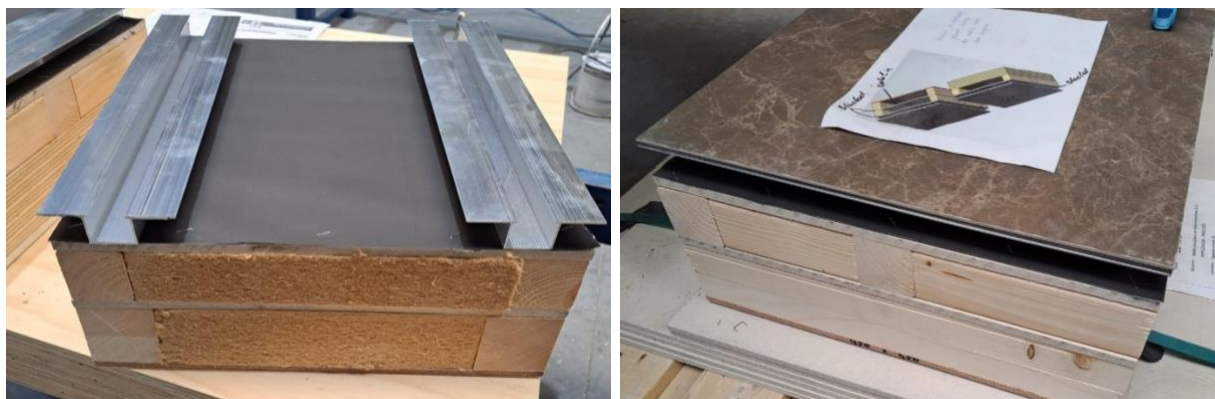

Figure 7: construction of the two small mock-up elements used for dissemination and communication purposes



Figure 8: The top and bottom anchors mounted in the test cabinet. Assembled the e-CLT anchor

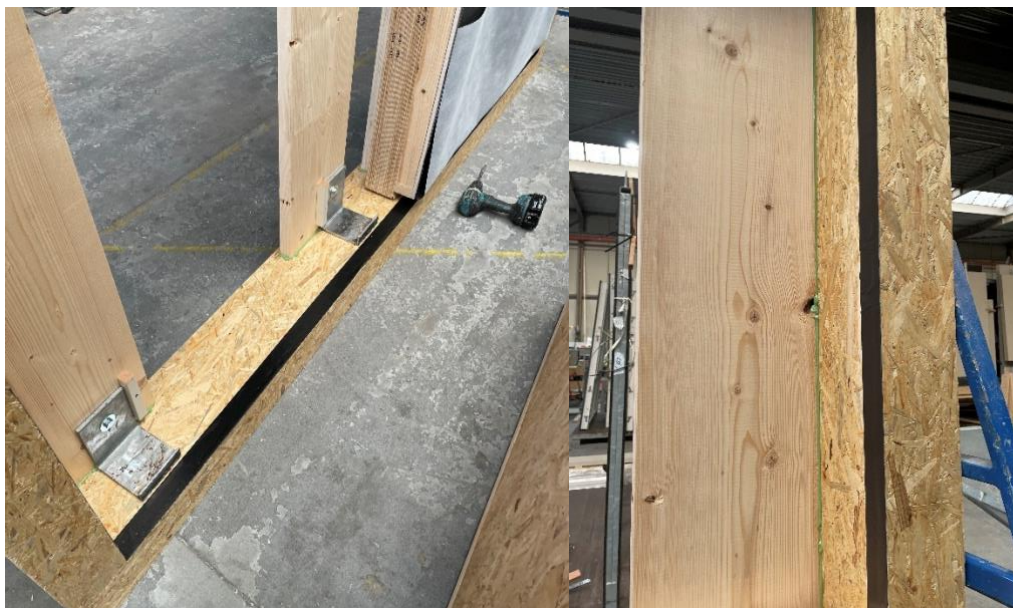

Figure 9: Waterproofing of the test cabinet



Figure 10: Placing the two lower elements: on the left the e-PANEL, on the right the e-CLT panel



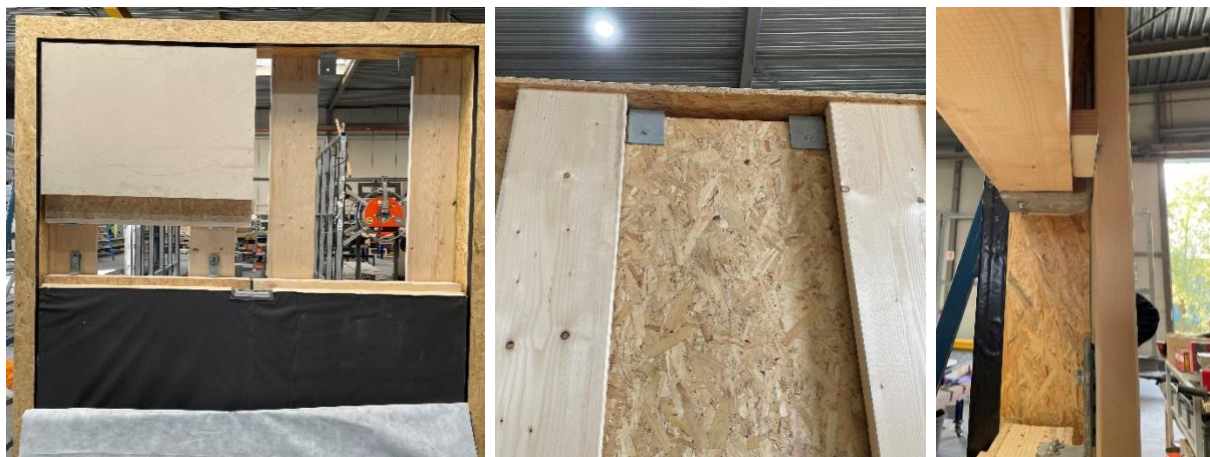

Figure 11: Placing the left upper element according to the e-PANEL.  
Placing the upper right element according to the e-CLT panel



Figure 12: Placing the upper right element according to the e-CLT panel



Figure 13: Water drip trays and waterproofing applied to the facade elements



Figure 14: Waterproof finish of the back-wall test cabinet



Figure 15: Placing the facade supports, waterproofing the front of the test cabinet and placing tiles





Figure 16: Front view and side view of facade elements in test cabinet

## 2.5 Lessons learned during design and production

The biggest challenge for this project, on a process level, was communication and the different requests and interests of the parties involved. As the two main collaborators on the design come from different GEO-clusters and have different backgrounds, the main challenge was to combine these different insights in a design that suits the **e-SAFE** project and pilot buildings and is also producible on an industrial scale.

On a product design level, the relative complexity of the design is a challenge. There are some special features for the design itself, one façade element consists out of five separate smaller elements. These must all fit together properly. During engineering, these elements take more time to design than a traditional prefabricated element. For real life implementation, this consideration should be considered for the engineering phase. The longer engineering time will also be reflected in the costs of the design.

### 3. Design and production of e-TANK

Based on the definitions of the heating and cooling system, and considering the number and routing of pipelines as well as the positioning of the storage tank, which are described in detail in Deliverable D3.3 [1], a prototype of the Plug & Play e-TANK has been created. In this manufacturing process, a detailed 3D model of the solution was created as a first step, in which all geometrical relationships and all containing components were precisely modeled. Subsequently, a prototype has been manufactured, which represents the design of the real application. Figure 17 shows both the 3D model and the prototype of the e-TANK system, which was installed in the test bench of the Pink Company.

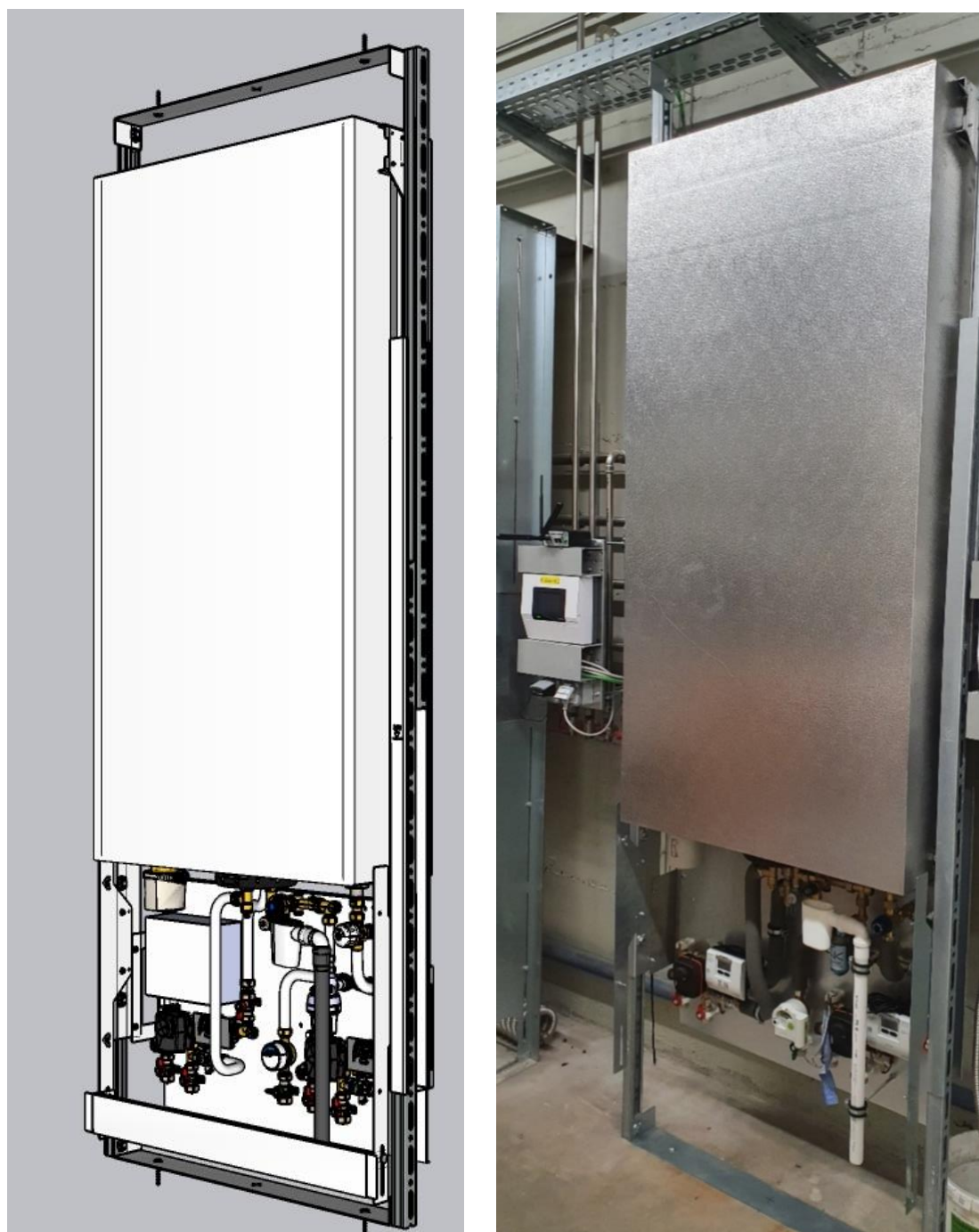

Figure 17: 3D-Model and Prototype of e-TANK plug & play solution

The **e-TANK** solution consists of two main subsystems, namely the “storage tank” and the “hydraulic module”. Both components will be connected and mounted on a steel frame, which then is fixed on the existing walls. The hydraulic scheme, which shows the linking of the two components as well as the integration of the **e-TANK** into the energy supply system of the building, is shown in Figure 18.

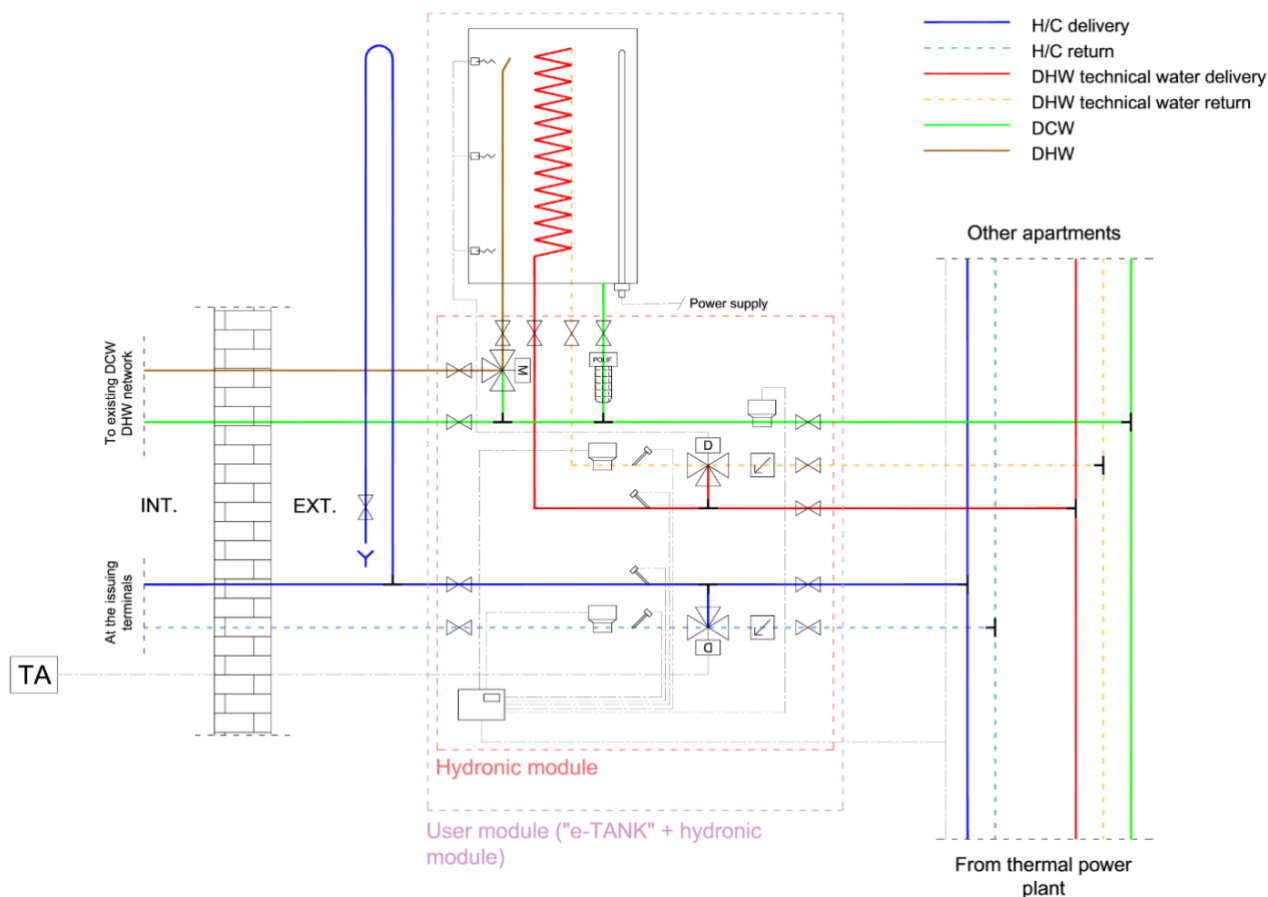

Figure 18: Scheme of **e-TANK** system

The *storage tank*, with a volume of 140 liters, has a flat design which was developed by the Pink company. It is built with five pieces of vertically oriented pipes with an inner diameter of 150 mm and welded together with horizontal connecting pipes on the top and the bottom. The central pipe is equipped with a screwed flange and equipped with a heat exchanger which is connected to a 2-pipe hot water network system powered by the central heat pump. It is made of molybdenum-bearing austenitic stainless steel, more resistant to general corrosion and pitting/crevice corrosion than the conventional stainless steels. An electric heater is also present to ensure periodic high temperature for the prevention of Legionella disease and to allow users heating up the water outside the central plant operation schedule. Picture and main technical data are reported in Figure 19.



<b>Technical data:</b>	
Material of the storage tank:	stainless steel -1.4571 (V4A)
Volume of the storage tank:	140 litres
Dimension (H/W/D):	~1750 mm / 920 mm / 300 mm
Max. allowable operating pressure:	6.0 bars
Testing pressure:	9.0 bars
Max. operating temperature:	95.0 °C
Weight (empty):	75.0 kg
Insulation:	PU rigid foam, CFC-free / vacuum insulation panel (VIP)
Stand-by consumption loss:	ca. 0,92 kWh / 24 h, energy label A
<b>Installation parts:</b>	
Inspection flange:	Stainless steel, inner diameter 150 mm (insulated with a flange cover with a fleece inlay)
Heat exchanger for DHW charging:	Stainless steel corrugated pipe heat exchanger (transfer area = 2.0 m <sup>2</sup> ) - recommended volume flow: 150 - 300 l/h - kv-Wert:1,22 / pressure loss: 15 – 60 mbar - volume: ~ 7 litres
Sensor tube:	Inner diameter 12 mm (for max. 3 temperature sensor each ø 6 mm) - the tube reaches the entire storage height

Figure 19: e-TANK Technical data

The integrated heat exchanger is made of stainless steel (type 1.4571) corrugated pipe, and located at the central storage pipe. Due to the surface of about 2 m<sup>2</sup>, there are generally very low temperature differences between technical water and domestic hot water during a charging process. As a result, the supply temperature for hot water preparation can be kept as low as possible, which in turn gives advantages while using low temperature heat sources (e.g. heat pump or solar thermal).

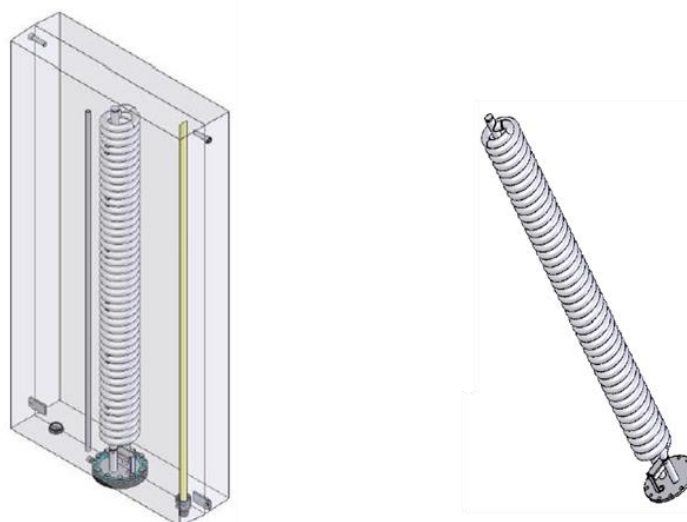

Figure 20: Internal heat exchanger of the storage tank

For the insulation of the tank, the same technical solution already developed in a previous research project named “BuildHeat” has been implemented. In particular, in addition to the conventional insulation by means of a PU foam, a further layer of vacuum insulating panels (VIP) was applied to the front and the back of the tank, by which additional insulation could be provided for the main surfaces. Finally, because of the fragile outer side of the VIP’s, an additional cover sheet of metal was designed to avoid damaging the insulation panels.

The used VIPs are illustrated in Figure 21, with the relevant technical data, while Figure 22 shows the construction method as well as the assembled prototype.



Technical data:	
Color:	silver
Dimension (H/W/D):	~1700 mm / 870 mm / 20 mm
Material:	Gas-tight outer envelope Rigid, highly porous core
Heat transfer coefficient:	0,32 W/(m <sup>2</sup> *K)
Conductivity:	0,007 W/mK
Density:	~200 kg/m <sup>3</sup>
Temperature resistance:	-70 °C bis 100 °C (briefly 120 °C)

Figure 21: Technical data of the Vacuum Insulations Panel (VIP)

This design significantly reduces the heat loss of the storage tank which brings great advantages, especially with regard to the planned external installation of the storage tank in the pilot building in Catania (for more details and values of such heat losses see also Section 4.2, Figure 38 and Figure 39).

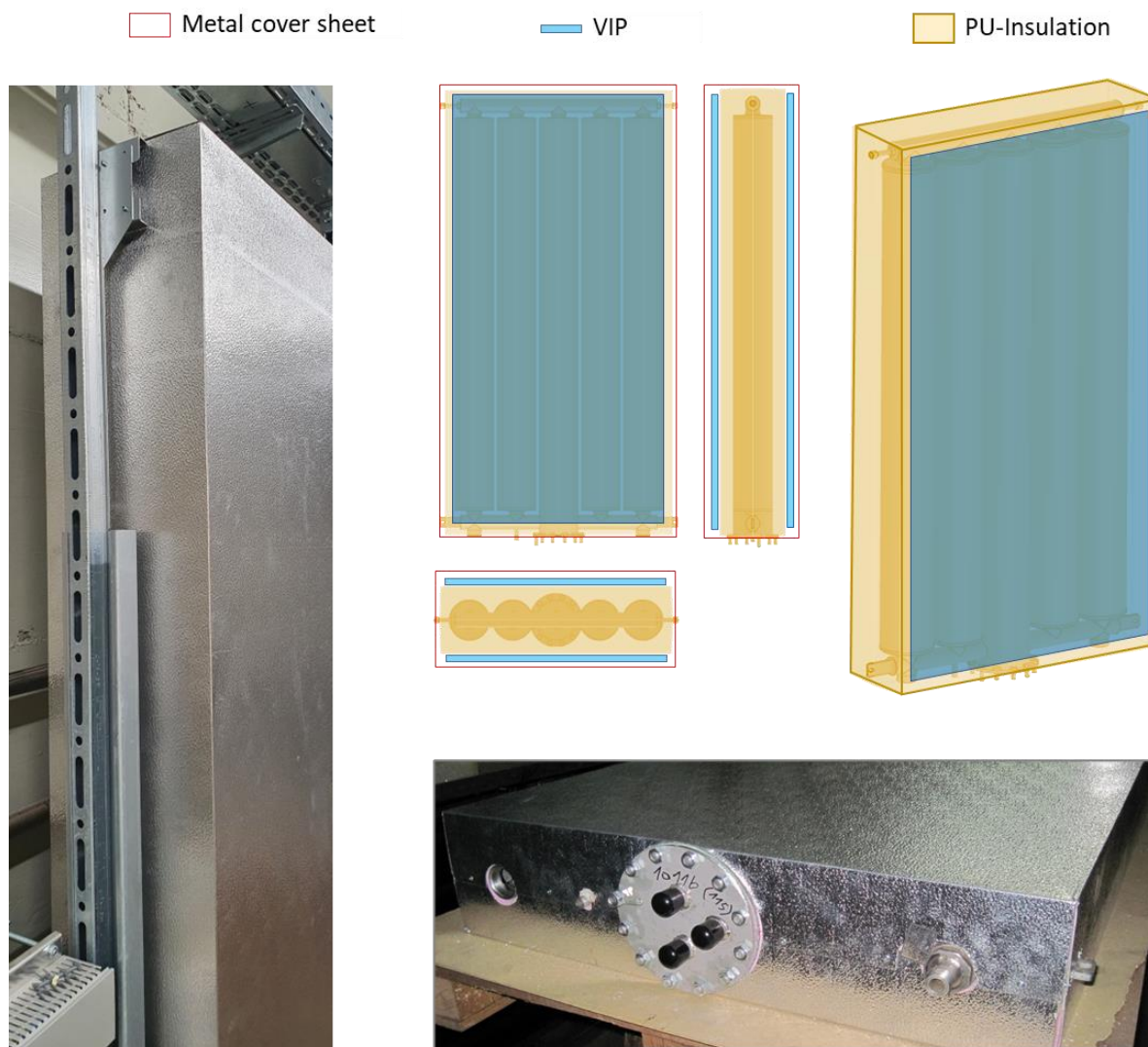

Figure 22: PU-foam insulated tank with additional VIPs

The *hydronic module* is a prefabricated module, in which all necessary components for the supply of DHW, cold drinking water as well as heating/cooling functions are installed. This hydronic module is installed directly below the storage tank and the configuration and components are specifically designed for the e-SAFE project. The prototype and the 3D-model of the hydronic module is shown in detail in Figure 23.

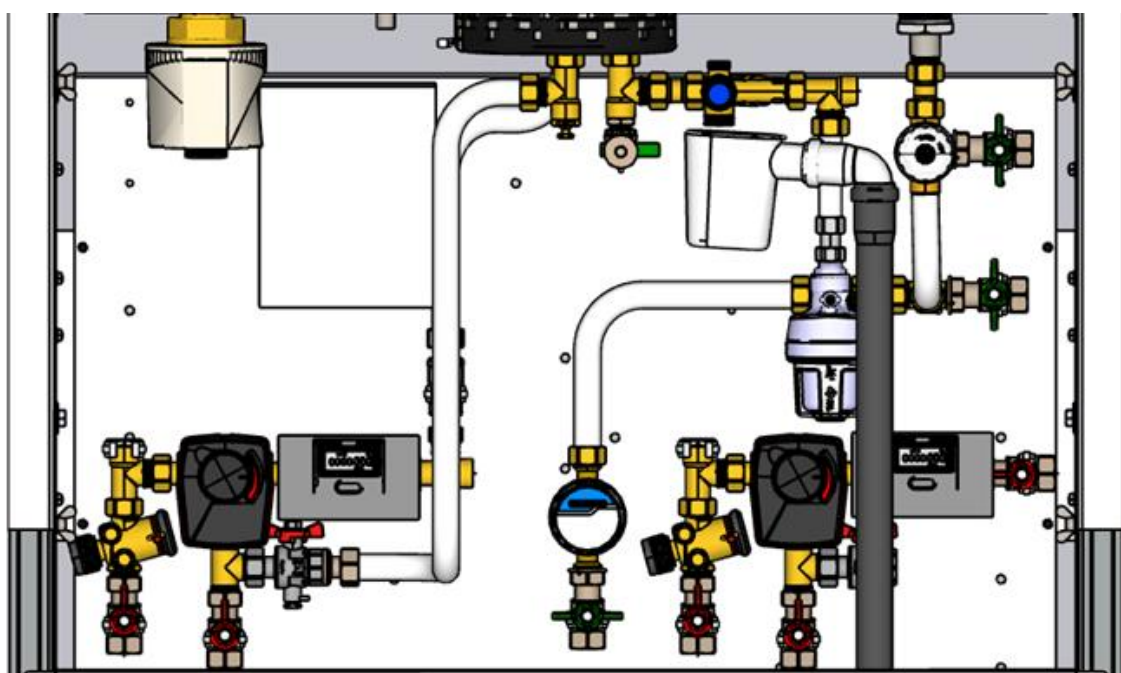

Figure 23: 3D-Model and Prototype of e-TANK hydronic module

Within the module, hydraulic, electric, and electronic components are installed. A list of the main components, as well as a detailed functional description and the positioning within the module can be seen below, whereby a separation into hydraulic and control and monitoring components were made.

#### 1 – Hydraulic components:

The security group is integrated in the supply line of the cold water: it serves to protect closed DHW preparator according to DIN 1988 [7] and DIN 4753 [8] and prevents the system from overpressure. According to the manufacturer's recommendations, the security group was installed very close to the heat exchanger of the storage tank. Of course, in order to dissipate the water that escaped during the charging process of the storage tank, a connection to the drain system of the building must also be provided, whereby a siphon is installed in the system as an odour barrier.

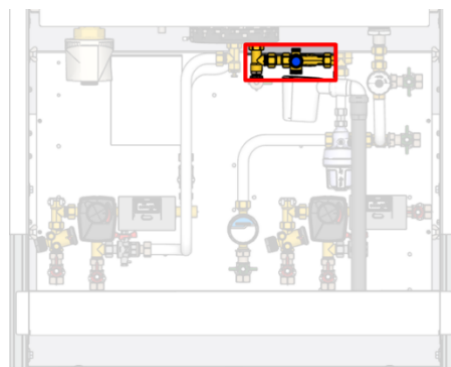

Figure 24: Hydronic unit – security group

The dynamic balancing valve is used to control the default flow rates (Figure 25). Specifically, it is a valve combination of an automatically operating flow controller (with a manually adjustable set point of the flow) and a control valve. It is installed in both supply lines (heating/cooling and DHW-preparation)

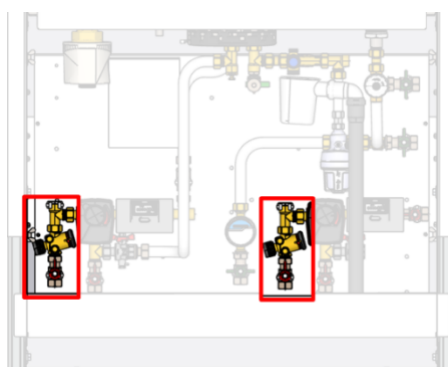

Figure 25: Hydronic unit - dynamic balancing valve

The thermostatic mixing valve is a thermostatically controlled three-way mixing valve for the safely limitation of the inlet temperature of the DHW supply lines to the dwelling (Figure 26). It ensures constant mixing temperatures at the tapping point and at the same time provides protection against scalding. The valve works independently and without any additional auxiliary energy.

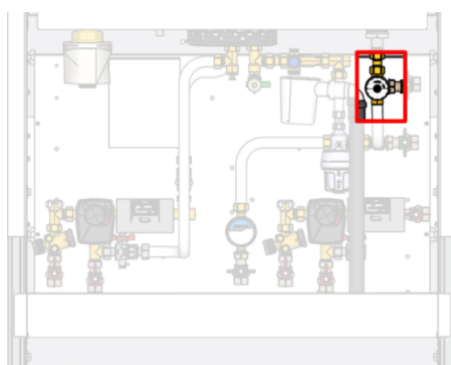

Figure 26: Hydronic unit – thermostatic mixing valve

The 3-way diverter valve regulates the mass flow and the corresponding thermal load into the supply lines of the heating/cooling and the DHW-circuit via an electrical on/off actuator (Figure 27). It is characterized by excellent regulation and the lowest internal leakage available on the market. Moreover, it allows the control of different control signals.





Figure 27: Hydronic unit – 3-way diverter valve and actuator

The polyphosphate dispenser limits limescale formation in the domestic water system and in the devices connected to it (Figure 28). It is installed into the domestic cold-water pipe supplying the instantaneous boiler. It helps to maintain the original heat exchange performance levels of the generator and heat exchanger in the DHW production circuit over time. The dosage of polyphosphates in the water is proportional to the amount of cold water passing through the device.

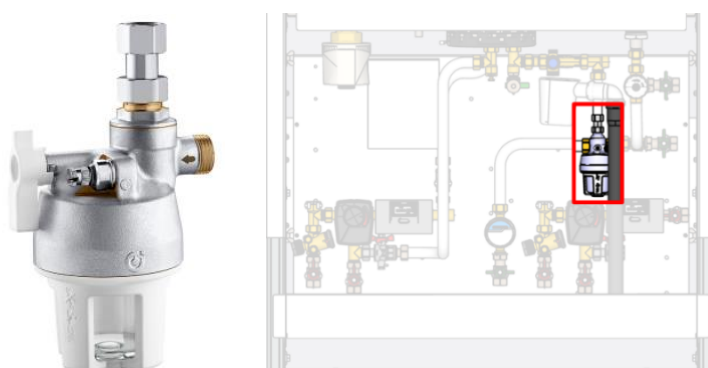

Figure 28: Hydronic unit – polyphosphate dispenser

## 2 – Control and Monitoring components:

The ultrasonic heat meter measures the heat/cold load, it is installed in the heating/cooling and the DHW circuit (Figure 29). The data loggers are fully programmable and can be set up to provide yearly, monthly, daily, hourly, and minutely values. This allows applications to be effectively analysed and diagnosed, enabling faster load profiling. Errors and inconsistencies can be detected more quickly. It has a low pressure drop, which requires a lower pump capacity.

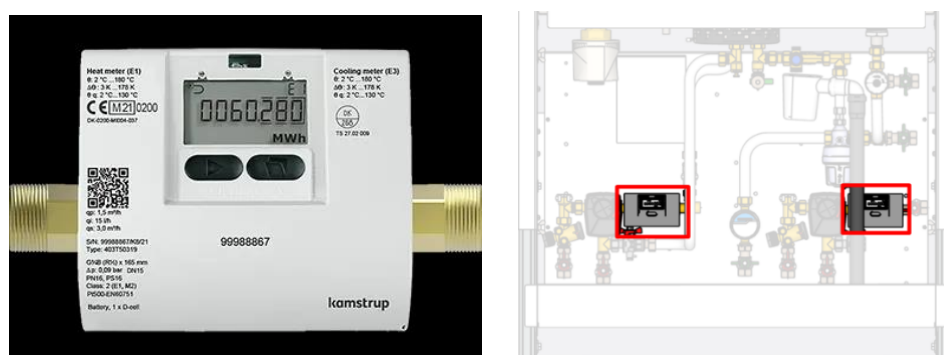

Figure 29: Hydronic unit – ultrasonic flow sensor

The cold-water meter is an electronic ultrasonic meter, which, unlike conventional mechanical meters, is wear-free (Figure 30). The water meter is designed and constructed as a vacuum chamber. It is IP68 rated, which means that it is protected against the intake of water and condensation in the display.



Figure 30: Hydronic unit – cold water flow sensor

The electrical heater is a heater for stainless steel tanks which is screwed into the tank via 1" ½ coupling. The heater coil consists of three U-shaped heating elements, which are fitted in a brass nipple. It is equipped with an electromechanical temperature controller and an unbreakable electromechanical safety temperature limiter according to EN 14597 [9]. The switch-off temperature can be set to the required temperature by turning the control knob. Thereby the range extends from off (0) through frost protection (\*) to approx. 85 °C. The heating element is available with different electrical outputs in the range from 1.0 to 4.5 kW, within the project the power was set to 1.5 kW.

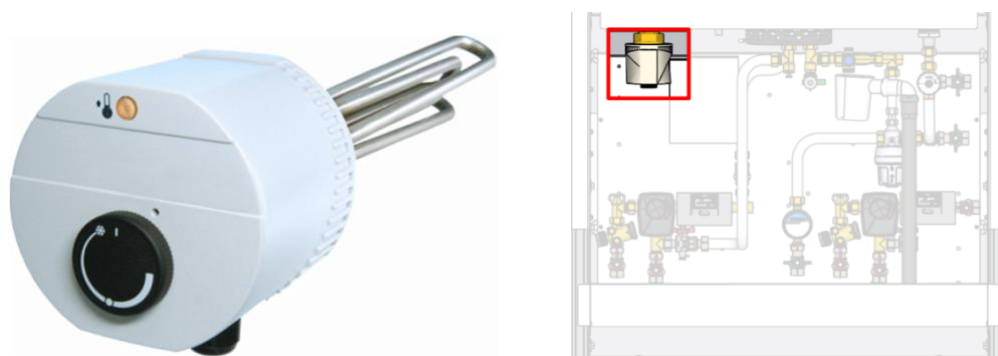

Figure 31: Hydronic unit – electrical heater

In the control cabinet of the hydraulic unit the electric and electronic cables of the installed components are wired (Figure 32). It also includes the PLC, via which the control and monitoring activities can be realized. Furthermore, a relay is installed here, which is needed for the operation of the electrical heating element of the hot water storage tank. Finally, the network connection enables the communication and data transfer with the central control system of the building.

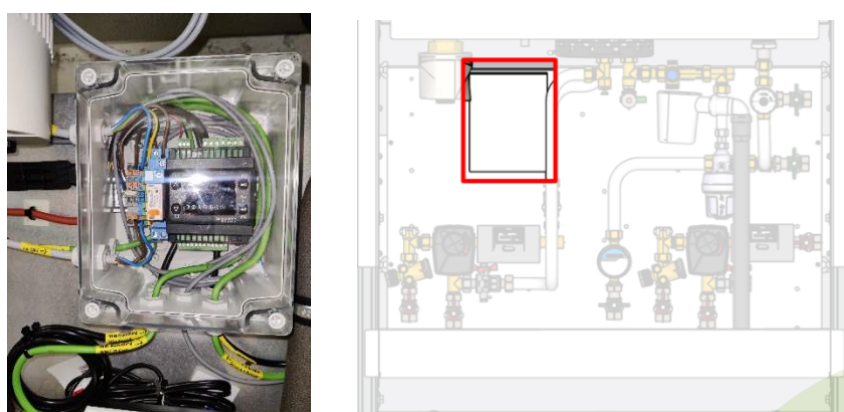

Figure 32: Hydronic unit – control cabinet

## 4. Testing results on Prototypes

This section provides a brief overview of the testing results and testing methods used. The section is divided into Section 4.1 (**e-CLT** and **e-PANEL**) and Section 4.2 (**e-TANK**).

### 4.1 Testing of e-CLT and e-PANEL

The **e-CLT** and **e-PANEL** were manufactured by WEBO in their production facility in Rijssen, the Netherlands, as shown in Section 2.4 of this report. This means that **e-CLT**, **e-PANEL** and cover were produced and put together as one integral piece of a façade. The tested façade replicates the real-world situation for the real pilot in Italy. After the manufacturing process, the mock-up was transported to SHR in Wageningen, the Netherlands. This institute is certified under NEN-EN-ISO/IEC 17025 [2] to test façade elements. The element is tested under SHR code 22.0280, which is the unique code under which the tests were carried out.

At SHR the façade element consisting out of the **e-CLT** and **e-PANEL** solution was tested on airtightness, watertightness and material fatigue. On all three tests the **e-SAFE** solutions performed great.

More in detail, in terms of air-tightness, the measured air loss was 2.48 m<sup>3</sup>/h per m<sup>2</sup> at 100 Pa and 11.35 m<sup>3</sup>/h per m<sup>2</sup> at 600 Pa, which under NEN-EN 12207 [3] means that **e-PANEL** and **e-CLT** achieved Class 3.

In terms of water-tightness, the **e-PANEL** and **e-CLT** achieved an impressive level of 600 Pa of water-tightness, which under NEN-EN 12208 [4] means these solutions achieve a Class 9A. A picture of the testing can be seen in Figure 33.

In terms of fatigue (i.e., the respect in which the façade, and its materials, can withstand a certain pressure) the strength of the panels was tested with pressure of +2400/-2400 Pa. The element withstood these very high pressures and under NEN-EN 12210 [5] achieved Class 4 performance.



Figure 33: Façade element during watertightness testing

## 4.2 Testing of e-TANK

The tank volume of 140 liters is designed to address both comfort and hygienic aspects. Figure 34 shows the discharge volume and the discharge capacity of tap water with a temperature of 40 °C (t-out) which can be taken out from the DHW-storage tank, whereby too hot water is mixed down via the cold-water inlet (t-in) with a temperature of 14 °C.

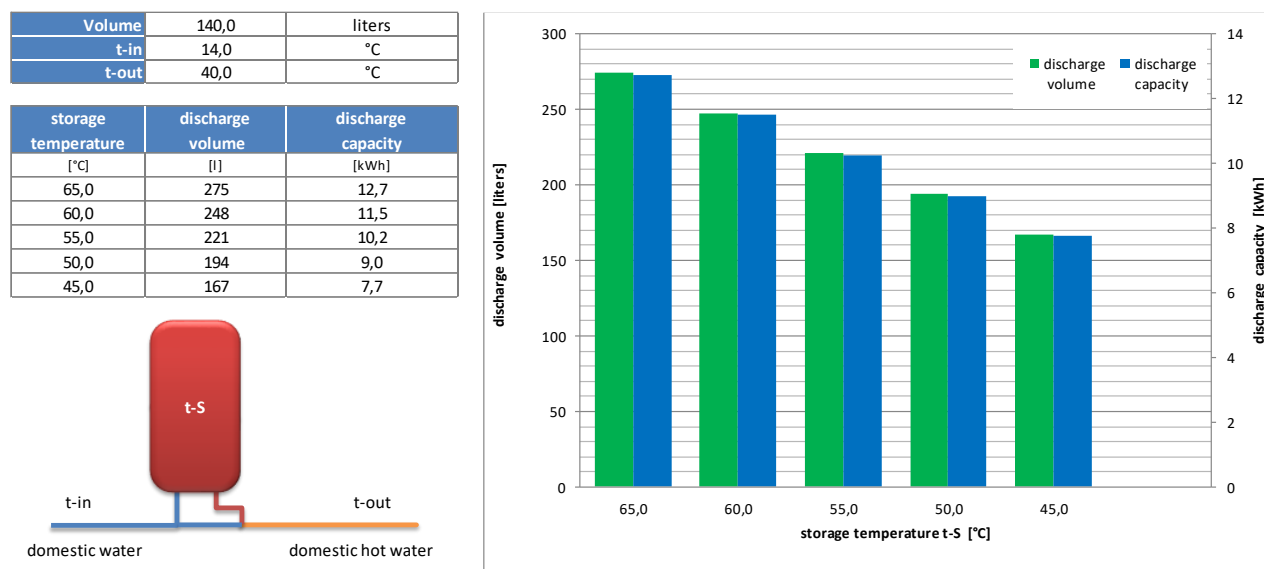

Figure 34: Tap water volume and capacity of the e-TANK for different temperatures

Because the heat exchanger reaches the top of the tank and it is operated in counter flow, hot water can be provided very fast compared to standard tanks, which typically have the heat exchanger positioned at the bottom. The charging process was measured for different charging conditions with regard to inlet temperatures and flow rates. Figure 35 shows an example of the course of the storage temperatures with such a procedure. These measurement data were also used for the calibration of the simulation model, which is already described in Deliverable D3.3 [1].

These product properties facilitate to fulfil certain regulations regarding legionella prevention, such as EN 806 [10], either by using the integrated heat exchanger with sufficient heat source temperature or by boosting the tank temperature by an optional electrical heating element.

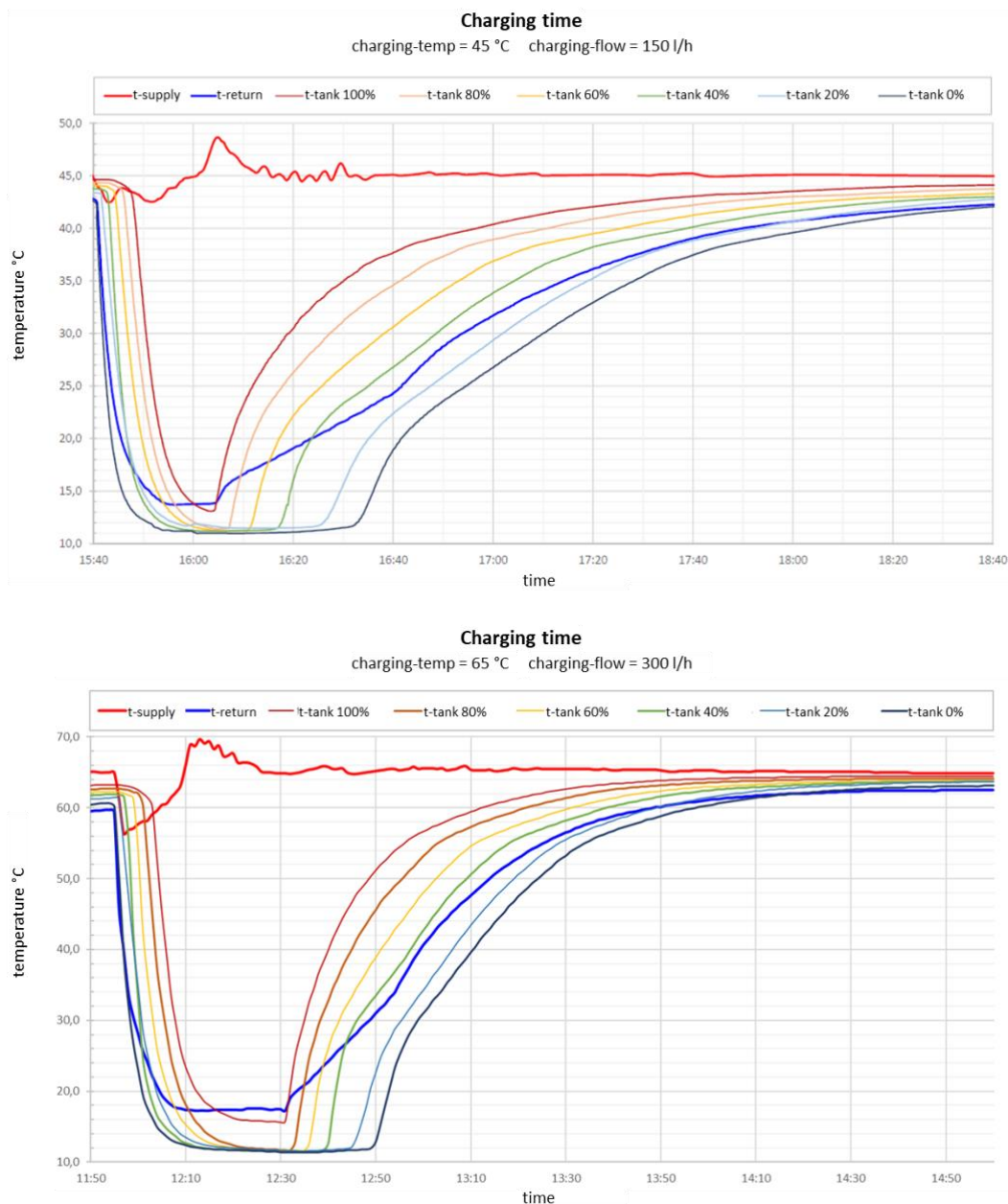

Figure 35: Temperatures of the e-TANK while charging with different parameters

Thanks to the design and the operation mode of the system, an excellent stratification of the water within the e-TANK is achieved. As the temperature in the tank is either hot or cold, this stratification is even positively influencing the hygienic quality of the concept. Long periods with warm water with a temperature between 30 and 40 °C (shown in yellow), which is ideal for bacterial growth, is avoided (see Figure 36). As shown in the illustration of the charging process over the period of 30 minutes, only a few layers of the tank are within this critical temperature range for only 10 minutes.

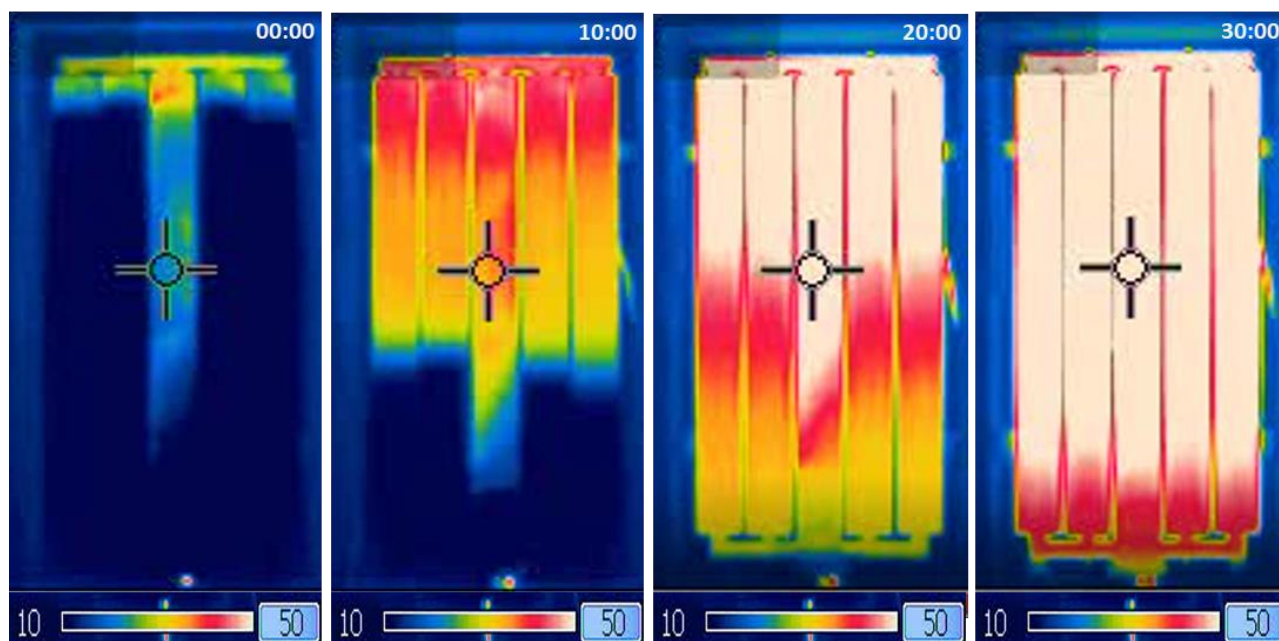

Figure 36: Stratification of the e-TANK during a charging period of 30 minutes

The stratification also remains very stable during the discharging process, as can be clearly seen in Figure 37. It shows a draining procedure in which the entire volume of the storage tank (140 L) is emptied within just 10 minutes. It can be seen that, despite the high withdrawal quantity, there is no mixing within the storage tank and therefore the entire storage volume is available with the maximum temperature.

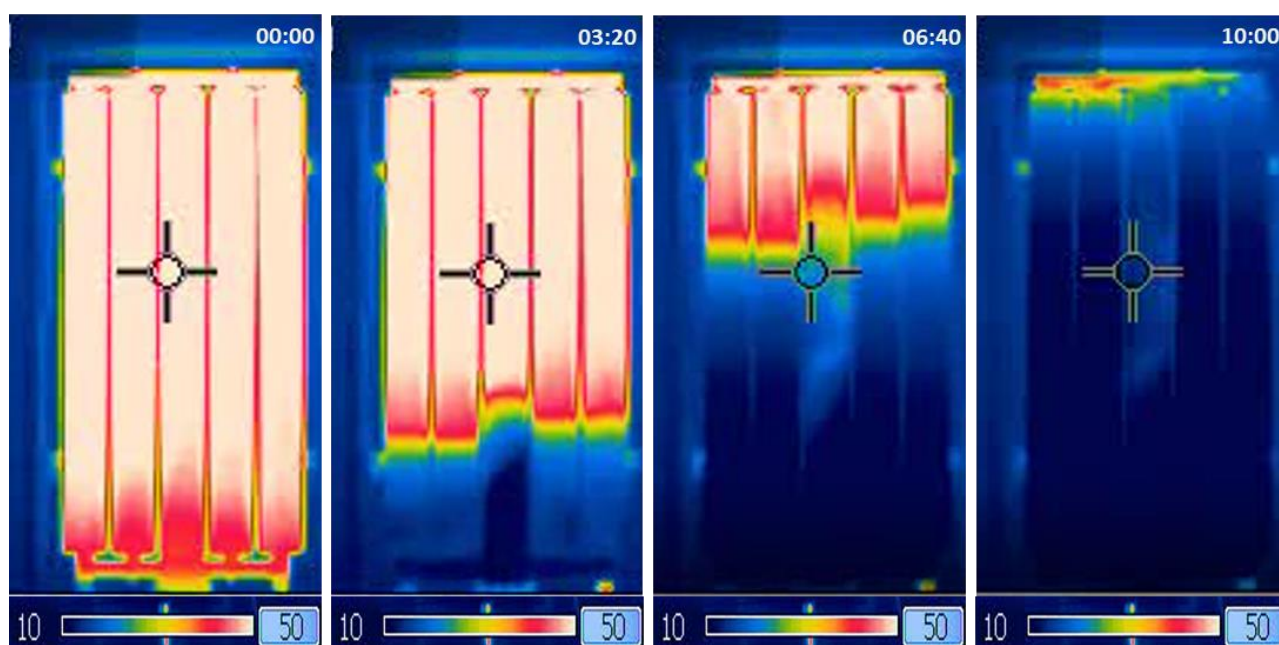

Figure 37: Stratification of the e-TANK during a discharging period of 10 minutes

As the specific surface of a flat domestic hot water tank is always higher than those of a standard tank in cylindrical form, the insulation quality of such a system is even more important. To achieve sufficiently low stand-by losses, the complex steel pipe structure of the tank is first covered by a PU hard foam insulation. The advantage of such an insulation is the gap-free covering of all components.

However, with this type of insulation it is only possible to reach energy efficient classes in the range of (C) or lowest (B), based on the EU Regulation 812/2013 (see Figure 38). Therefore, only additional insulation via the integrations of the VIPs, which was already described previously, enables the achievement of the highest energy efficiency levels (A).

Energy efficiency of hot water storage tanks					
according to COMMISSION DELEGATED REGULATION (EU) No 812/2013					
140 tank volume in litres					
	from	to		from	to
<b>A+</b>		28,3	W		679,5
<b>A</b>	28,3	39,2	W	679,5	940,3
<b>B</b>	39,2	54,8	W	940,3	1315,3
<b>C</b>	54,8	76,8	W	1315,3	1843,0
<b>D</b>	76,8	95,6	W	1843,0	2293,6
<b>E</b>	95,6	124,6	W	2293,6	2990,5
<b>F</b>	124,6	151,3	W	2990,5	3630,3
<b>G</b>	151,3		W	3630,3	

Figure 38: Energy efficiency classes of hot water storage tanks (EU 812/2013)

Based on the measurements of the stand-by losses, which were about 920 Wh/day for the hot water tank of the e-TANK system, the energy label shown in Figure 39 could finally be drawn up.

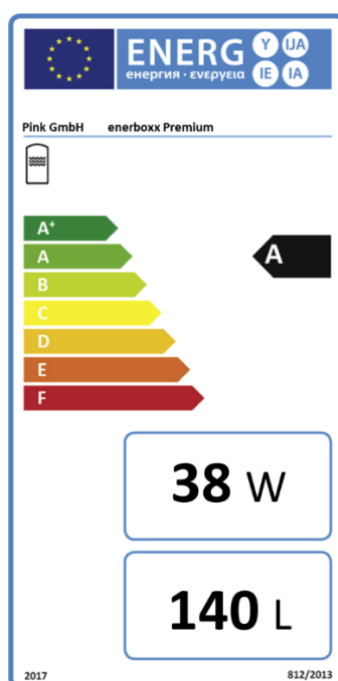

Figure 39: Energy Label of the e-TANK (hot water storage tank) (EU 812/2013)

## 5. CONCLUSIONS

The testing of the **e-PANEL** and **e-CLT**, took place under NEN-EN-ISO/IEC 17025 [2]. These tests were carried out successfully by testing body SHR in Wageningen (NL). The new innovative **e-SAFE** solutions proved to be a success and delivered a positive result during testing of both watertightness and fatigue.

### Results: testing **e-PANEL** and **e-CLT**

The **e-PANEL** and **e-CLT** were tested together to replicate the real-world pilot in one integral façade. These results are shown in Table 1.

Main lessons learnt in the design phase of **e-CLT** and **e-PANEL** are: 1. Integrating knowledge from different geo-clusters is a time-consuming process. 2. Complex design reflects in engineering time and production time.

Table 1: Test results for e-CLT and e-PANEL

	<b>Airtightness</b>	<b>Watertightness</b>	<b>Fatigue</b>
Result	Measured air loss was 2.48 m <sup>3</sup> /h per m <sup>2</sup> at 100 Pa and 11.35 m <sup>3</sup> /h per m <sup>2</sup> at 600 Pa	600 Pa	+2400/-2400 Pa
Class	Class 3 under NEN-EN 12207	Class 9A under NEN-EN 12210	Class 4 under NEN-EN 12210

### Results: testing **e-TANK**

The **e-TANK** solution was produced in Austria and tested for energy labels under EU Regulation 812/2013 [6]. Different measurements were done, demonstrating 920 Wh/day stand-by losses. Under EU Regulation 812/2013 [6], this translates into an achieved energy label of A.



## REFERENCES

### Internal references

---

- [1] Deliverable 3.3: Design of the e-SAFE technologies

### External references

---

- [2] NEN-EN-ISO/IEC 17025:2018. General requirements for the competence of testing and calibration laboratories. Nederlands Normalisatie-Instituut; 2018 (in Dutch)
- [3] NEN-EN 12207:2016. Windows and doors – Air permeability – Classification. Nederlands Normalisatie-Instituut; 2016
- [4] NEN-EN 12208:1999. Windows and doors - Watertightness – Classification. Nederlands Normalisatie-Instituut; 1999
- [5] NEN-EN 12210:2016. Windows and doors - Resistance to wind load – Classification. Nederlands Normalisatie-Instituut; 2016
- [6] COMMISSION DELEGATED REGULATION (EU) No 812/2013 of 18 February 2013 supplementing Directive 2010/30/EU of the European Parliament and of the Council with regard to the energy labelling of water heaters, hot water storage tanks and packages of water heater and solar device
- [7] DIN 1988-100. Codes of practice for drinking water installations - Part 100: Protection of drinking water, drinking water quality control; DVGW code of practice. Deutsches Institut für Normung; 2011
- [8] DIN 4753-3. Water heaters, water heating installations and storage water heaters for drinking water - Part 3: Corrosion protection on the water side by enamelling and cathodic protection - Requirements and testing. Deutsches Institut für Normung; 2017
- [9] EN 14597:2012. Temperature control devices and temperature limiters for heat generating systems. European Committee for Standardization; 2012
- [10] EN 806-1:2000. Specifications for installations inside buildings conveying water for human consumption - Part 1: General. European Committee for Standardization; 2000

## ACKNOWLEDGEMENTS

This deliverable was carried out in the framework of the *Energy and seismic affordable renovation solutions (e-SAFE)* project, which has received funding from the European Union's Horizon 2020 research and innovation programme under grant agreement No. 893135.

