

Improved Fuzzy Neural Modeling for Underwater Vehicles

O. Hassanein, Sreenatha G. Anavatti, and Tapabrata Ray

Abstract—The dynamics of the Autonomous Underwater Vehicles (AUVs) are highly nonlinear and time varying and the hydrodynamic coefficients of vehicles are difficult to estimate accurately because of the variations of these coefficients with different navigation conditions and external disturbances. This study presents the on-line system identification of AUV dynamics to obtain the coupled nonlinear dynamic model of AUV as a black box. This black box has an input-output relationship based upon on-line adaptive fuzzy model and adaptive neural fuzzy network (ANFN) model techniques to overcome the uncertain external disturbance and the difficulties of modelling the hydrodynamic forces of the AUVs instead of using the mathematical model with hydrodynamic parameters estimation. The models' parameters are adapted according to the back propagation algorithm based upon the error between the identified model and the actual output of the plant. The proposed ANFN model adopts a functional link neural network (FLNN) as the consequent part of the fuzzy rules. Thus, the consequent part of the ANFN model is a nonlinear combination of input variables. Fuzzy control system is applied to guide and control the AUV using both adaptive models and mathematical model. Simulation results show the superiority of the proposed adaptive neural fuzzy network (ANFN) model in tracking of the behavior of the AUV accurately even in the presence of noise and disturbance.

Keywords—AUV, AUV dynamic model, fuzzy control, fuzzy modelling, adaptive fuzzy control, back propagation, system identification, neural fuzzy model, FLNN.

I. INTRODUCTION

THE AUV have gained importance over the years as specialized tools for performing various underwater missions in military and civilian operations. The autonomous control of underwater vehicles poses serious challenges due to the AUVs' dynamics. AUVs dynamics are highly nonlinear and time varying and the hydrodynamic coefficients of vehicles are difficult to estimate accurately because of the variations of these coefficients with different navigation conditions and external disturbances. The main advantage of the AUV is that it does not need a human operator. Therefore, is capable of doing operations that are too dangerous for humans.

O. Hassanein is a research scholar with the School of Engineering and Information Technology, University of New South Wales at Austerlian Defence Force Academy. Canberra, ACT 2600, Australia (e-mail: o.hassan@adfa.edu.au).

Sreenatha G. Anavatti is a senior lecturer with the School of Engineering and Information Technology, University of New South Wales at Austerlian Defence Force Academy. Canberra, ACT 2600, Australia (e-mail: s.anavatti@adfa.edu.au).

Tapabrata Ray is a senior lecturer with the School of Engineering and Information Technology, University of New South Wales at Austerlian Defence Force Academy. Canberra, ACT 2600, Australia (e-mail: t.ray@adfa.edu.au).

Applications of AUVs can be divided into three groups [1]. These three groups are maritime (marine) security, oceanography, and submerged structure inspection and maintenance. According to [2] the two most significant technological challenges in AUV's design are power and autonomy. Power sources limit the mission time of the vehicle and autonomy limits the degree to which an AUV can be left unattended by human operators.

As presented in [1], the fuzzy system is used as a system identifier for nonlinear dynamic system. They show that the fuzzy system can be viewed as a three-layer feed forward network. The neuro-fuzzy modeling techniques are presented in [2]. The system identification is a powerful approach for that technique and was demonstrated by its application to the identification of an Ocean Voyager AUV.

Reference [3] was concerned with practical System Identification (SI) method in order to obtain a model of AUV using input-output data obtained from test trials. The autopilot deployed was an LQG controller. Reference [4] presented a simple model identification method for UUV and applied this method to the underwater robot GARBI. The system identification was aimed at decoupling the different degrees of freedom in low speed vehicles. The indirect adaptive fuzzy controller is presented in [5] that do not require an accurate mathematical model of the system. The simulation results show that the adaptive controller is capable to track the system without using any linguistic information and after incorporating some linguistic fuzzy rules, the adaption speed became faster.

A neural fuzzy system based on modified differential evolution for nonlinear system control is discussed in [6]. This controller is applied to the planetary-train-type inverted pendulum system and the magnetic levitation system. As presented in [7], The FLNN (functional link NN) is capable of estimation of pressure quite accurately irrespective of nonlinear characteristics of the CPS (capacitor pressure sensor) and its temperature dependence.

The FLNN is a single-layer neural structure capable of forming arbitrarily complex decision regions by generating nonlinear decision boundaries with nonlinear functional expansion. The FLNN [8] was conveniently used for function approximation and pattern classification with faster convergence rate and less computational loading than a multilayer neural network.

ADFA AUV has been developed and built in UNSW@ADFA. The hydrodynamic coefficients of this AUV are calculated under certain conditions using CFD method to derive the exact mathematical model. Simulation program is built up to simulate the dynamic behaviour of the AUV based

upon the calculated mathematical model of the AUV. This work is going to deal with system identification based upon on-line adaption techniques of AUV dynamics. The only information required for training the fuzzy and neural fuzzy systems is the input-output data with very simple prior knowledge of the physical relationship inside the system and it offers a 'black box' modeling tool.

This study proposes an online system identification of AUV dynamics as a black box that has an input-output relationship instead of using the mathematical model with hydrodynamic parameters to obtain an accurate dynamic model to overcome the uncertainty, nonlinearity and the difficulties of modeling the AUVs. The development of the AUV dynamic model identification is based upon fuzzy and hybrid neural fuzzy techniques with online adaptive and learning algorithm.

The general dynamic equation describing the mathematical model of the ADFA AUV is provided in Section II. The design details of the system identification using fuzzy system and adaptive fuzzy model are discussed in section III. The design details of identification of AUV using adaptive neural fuzzy network (ANFN) techniques are presented in section IV. Moreover, the convergence analysis is discussed in section V. Numerical simulation results are presented in section VI. Finally, the paper is concluded in Section VII.

II. AUV'S MATHEMATICAL MODEL

Fig. 1 shows a typical underwater vehicle model. One electrical thruster powers the vehicle for forward motion. Two electrical pumps are used for maneuvering in the horizontal plane. In addition, two electrical pumps help the AUV to navigate in the vertical plane. The middle section is used for carrying the sensors, battery and the electronic accessories.

The hydrodynamic forces per unit mass acting on each axis will be denoted by the uppercase letters X, Y and Z. u , v and w represent the forward, lateral and vertical velocities along x , y and z axes respectively. Similarly, the hydrodynamic moments on AUV will be denoted by L , M and N acting around x , y and z axis respectively. The angular rates will be denoted by p , q and r along x , y and z axes respectively.



Fig. 1 Australian Defense Force Academy AUV

Dynamics of AUVs, including hydrodynamic parameters uncertainties, are highly nonlinear, coupled, and time varying. According to [9], the six degrees-of-freedom nonlinear equations of motion of the vehicle are defined with respect to two coordinate systems as shown in Fig. 2.

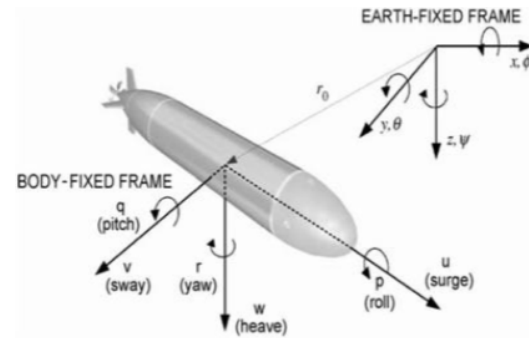

Fig. 2 Six degrees of freedom of an AUV

The equations of motion for the AUV are derived from Newton's second law of motion. The equation of motion for underwater vehicle can be written as follows [12]:

$$M\ddot{q} + C(\dot{q})\dot{q} + D(\dot{q})\dot{q} + G(q) = \tau \quad (1)$$

where M is a 6x6 inertia matrix as a sum of the rigid body inertia matrix, M_R and the hydrodynamic virtual inertia (added mass) M_A . $C(\dot{q})$ is a 6x6 Coriolis and centripetal matrix including rigid body terms $C_R(\dot{q})$ and terms $C_A(\dot{q})$ due to added mass. $D(\dot{q})$ is a 6x6 damping matrix including terms due to drag forces. $G(q)$ is a 6x1 vector containing the restoring terms formed by the vehicle's buoyancy and gravitational terms. τ is a 6x1 vector including the control forces and moments.

The dynamic models of thrusters and pumps have been included in the present study. The AUV model is simulated by a mathematical model based on physical laws and design data of the ADFA AUV.

III. FUZZY SYSTEM IDENTIFICATION OF AUV

The nature of fuzzy logic does have a good dynamic performance and offers a control solution when a mathematical model is not well known or not known at all. Fuzzy systems are known for their capabilities to approximate any nonlinear dynamic system [11]. The main idea of fuzzy control is to build a model of a human control expert who is capable of controlling the plant without thinking in mathematical model terms [12].

Fuzzy Modeling is the method of describing the characteristics of a system using fuzzy rules, and it can express complex non-linear dynamic systems by linguistic if-then rules [13].

The fuzzy rule base consists of a collection of fuzzy IF-THEN rules.

$$R^{(l)}: \text{IF } (x_1 \text{ is } F_1^l \text{ and } \dots \dots \text{ and } x_n \text{ is } F_n^l) \text{ THEN } y \text{ is } G^l \quad (2)$$

where $x = (x_1, \dots, x_n)^T \in U$ and $y \in R$ are the inputs and outputs of the fuzzy system, respectively, F_i^l and G_i^l are labels of fuzzy sets in U , and R , respectively, and $l = 1, 2, \dots, M$.

As [14], the AUV's fuzzy modeling is constructed based

upon the input-output data that has been characterized from the open loop system results of the AUV's mathematical model. The input data is considered as the force generated by thruster or pump which moves the AUV in a certain direction, and the output data is considered as the resulted linear or angular velocity of the vehicle taking into account the coupling effect of the other degree of freedom in that direction. Fig. 3 shows the configuration of the proposed fuzzy model that consists of three fuzzy systems that represent surge, pitch and yaw dynamics.

In the present work, the Gaussian membership functions are used in the fuzzy model. Fuzzy inference based upon a product sum is considered with the centre of area defuzzification method. The configuration of a fuzzy model system consists of five fuzzy models that represent surge, sway, heave, pitch and yaw dynamics.

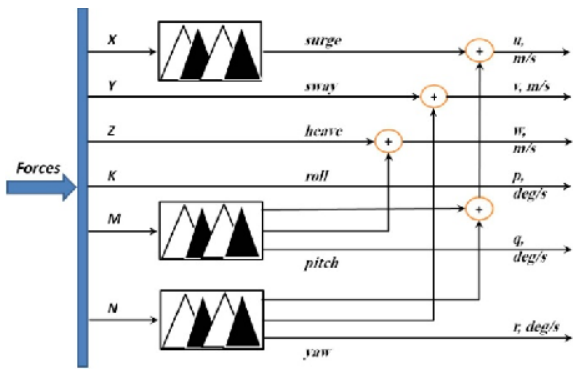

Fig. 3 The configuration of the fuzzy modeling for the AUV

For surge, pitch and yaw fuzzy models, the input is the force required for the thruster to produce the desired motion of the AUV. The output of the surge fuzzy model is the linear velocity in x-direction, u , in forward motion. There are three outputs for the fuzzy mode in pitch and yaw motions. Fig. 4 and Fig. 5 show the surge fuzzy model input and output respectively. The first output of the fuzzy model in pitch and yaw motions is the linear velocity in x-direction and this output represents the coupling effect on forward direction, which means the effect of the pitch or yaw motion on forward motion. The second output represents the coupling effect on heave and sway directions respectively. The third output is the angular velocity about y and z-axes respectively.

A. Adaptive Fuzzy Model Structure

The adaptive fuzzy model is a fuzzy model with a training algorithm where the model is synthesized from a bundle of fuzzy If-Then rules. Each fuzzy membership is characterized by certain parameters. The training algorithm adjusts these parameters based on numerical inputs and outputs data.

As shown in Fig. 6, the fuzzy model is placed in parallel with the process to be identified. It aims to identify the fuzzy model of the process online by using the input-output measurements of the process based on a training algorithm. A back propagation method is used to adapt the fuzzy model parameters online based on the error between the identified model and the actual output of the process.

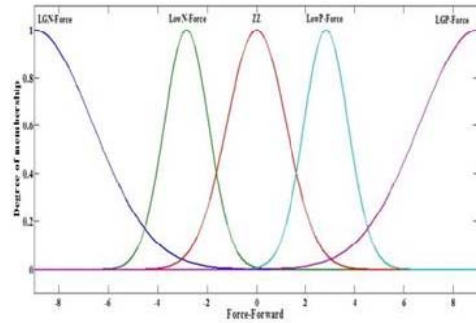

Fig. 4 Forward force membership function

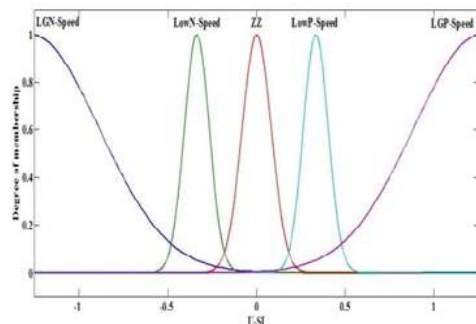

Fig. 5 Linear velocity in x-direction membership function

The final output of the fuzzy model is given by (3) with c_i^l and σ_i^l representing the centre and width of Gaussian memberships for input variable x_i for the rule i, l and n being the number of rules of fuzzy model and number of inputs respectively.

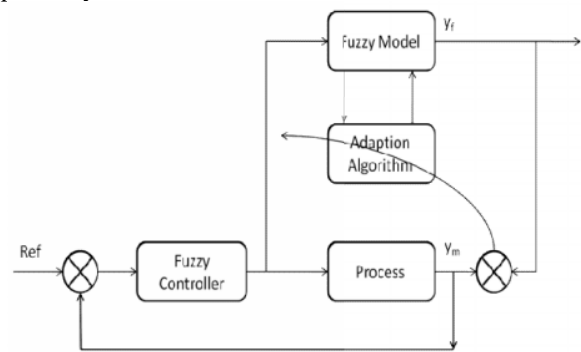

Fig. 6 Tracking of error function between the process and fuzzy model.

$$y_m(k+1) = \frac{\sum_{l=1}^M B^l \left| \prod_{i=1}^n \exp \left(-0.5 \left(\frac{x_i - c_i^l}{\sigma_i^l} \right)^2 \right) \right|}{\sum_{l=1}^M \left| \prod_{i=1}^n \exp \left(-0.5 \left(\frac{x_i - c_i^l}{\sigma_i^l} \right)^2 \right) \right|} \quad (3)$$

The gradient method is used to adapt the fuzzy controller parameters (c_i^l, σ_i^l and B^l) based on the following objective function

$$E(k) = \frac{1}{2} (y_m(k+1) - y_f(k+1))^2 \quad (4)$$

where $E(k)$ is error between the fuzzy model and the actual plant outputs. If $Z(k)$ represents the parameter to be adapted at iteration k in the fuzzy controller, the back propagation algorithm seeks to minimize the value of the objective function by [15];

$$z(k+1) = z(k) - \alpha \frac{\partial E}{\partial Z} \quad (5)$$

To train B^l ;

$$B^l(k+1) = B^l(k) - \alpha \frac{y_m - y_f}{b} z^l \quad (6)$$

where

$$b = \sum_{i=1}^M Z^l; Z^l = \prod_{i=1}^n \exp \left(-0.5 \left(\frac{x_i - c_i^l}{\sigma_i^l} \right)^2 \right) \quad (7)$$

Similarly, the update rule for parameters and is derived. The learning rate α in (5) [16] has a significant effect on the stability and convergence of the system. A higher learning rate may enhance the convergence rate but can reduce the stability of the system. A smaller value of the learning rate guarantees the stability of the system but slows the convergence. The proper choice of the learning rate is therefore very important. The convergence analysis of the models will be discussed later.

IV. ANFN SYSTEM IDENTIFICATION OF AUV

The ANFN uses a nonlinear combination of input variables (FLNN) [7] with the fuzzy system. Each fuzzy rule corresponds to the FLNN, comprising a functional expansion of input variables. The FLNN, initially proposed by [8], is a single-layer ANN structure capable of forming complex decision regions by generating nonlinear decision boundaries. In a FLNN, the need of hidden layer is removed. In contrast to linear weighting of the input pattern produced by the linear links of a MLP, the functional link acts on an element or the entire pattern itself by generating a set of linearly independent functions.

In this study, the functional expansion block comprises of a subset of orthogonal polynomials bases function. The FLNN has been inserted to the consequent part of the fuzzy rules. The local properties of the consequent part in the ANFN model enable a nonlinear combination of input variables to be approximated more effectively.

A. Functional Link Neural Network Structure

The FLNN is a single-layer network while the input variables generated by the linear links of neural networks are linearly weighted, the functional link acts on an element of input variables by generating a set of linearly independent

functions, orthogonal polynomials for a functional expansion, and then evaluating these functions with the variables as the arguments. Therefore, the FLNN structure considers trigonometric functions.

The theory behind the FLNN for multidimensional function approximation has been discussed in [6]. Consider a set of basis functions $B = \{\varphi_k \in \Phi(A)\}_{k \in K}$, $K = \{1, 2, \dots\}$. Let $B = \{\varphi\}_{k=1}^M$ be a set of basis function. The FLNN comprises M basis functions $\{\varphi_1, \varphi_2, \dots, \varphi_M\} \in B_M$. The linear sum of the j^{th} node is given by

$$\hat{y}_j = \sum_{k=1}^M w_{kj} \varphi_k(X) \quad (8)$$

where $X \in A \subset \mathcal{R}^N$, $X = [x_1, \dots, x_N]^T$ is the input vector and $W_j = [w_{j1}, \dots, w_{jM}]^T$ is the weight vector associated with the j^{th} output of the FLNN. \hat{y}_j denotes the local output of the FLNN structure and the consequent part of the j^{th} fuzzy rule in the ANFN model. In the FLNN structure as shown in Fig. 7, a set of basis functions Φ and a fixed number of weight parameters W represent $f_{W(X)}$.

The m -dimensional linear output may be given by $\hat{y} = W\Phi$, where $\hat{y} = [\hat{y}_1, \hat{y}_2, \dots, \hat{y}_m]^T$, m denotes the number of functional link bases, which equals the number of fuzzy rules in the ANFN model, and W is an $(m \times M)$ -dimensional weight matrix of the FLNN given by $W = [w_1, w_2, \dots, w_M]^T$.

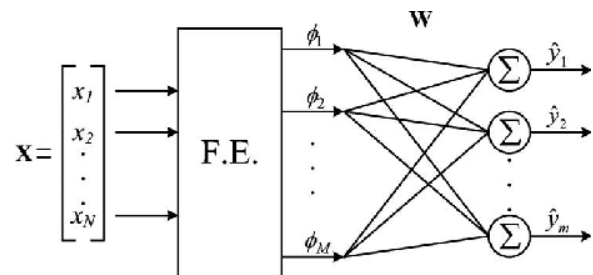

Fig. 7 FLNN structure

B. ANFN Model Structure

The ANFN model uses a nonlinear combination of input variables (FLNN). Each fuzzy rule corresponds to a sub-FLNN, comprising a functional link. The structure of the ANFN model is presented in Fig. 8. The ANFN model changes a fuzzy IF-THEN rule in the following form.

$$\begin{aligned} R^{(l)}: & \text{IF } (x_1 \text{ is } F_1^l \text{ and } \dots \dots \text{ and } x_N \text{ is } F_N^l) \text{ THEN} \\ & \hat{y}_j = \sum_{i=1}^M w_{ij} \varphi_k(X) \\ & = w_{1j} \varphi_1 + w_{2j} \varphi_2 + \dots + w_{Mj} \varphi_M \end{aligned} \quad (9)$$

where x_i and \hat{y}_j are the input and local output variables, respectively; F_N^l is the linguistic term of the precondition part with Gaussian membership function, N is the number of input variables, w_{ij} is the link weight of the local output, φ_M is the basis trigonometric function of input variables, M is the

number of basis function, and rule j is the j^{th} fuzzy rule.

The output of the fuzzy model in (3) with c_i^l and σ_i^l that representing the centre and width of Gaussian memberships for input variable x_i is changed to meet the requirement for ANFN model and become following form:

$$y_m(k+1) = \frac{\sum_{l=1}^M \hat{y}_l \left[\prod_{i=1}^n \exp \left(-0.5 \left(\frac{x_i - c_i^l}{\sigma_i^l} \right)^2 \right) \right]}{\sum_{l=1}^M \left[\prod_{i=1}^n \exp \left(-0.5 \left(\frac{x_i - c_i^l}{\sigma_i^l} \right)^2 \right) \right]} \quad (10)$$

The learning process involves determining the minimum of a given cost function (4). The gradient of the cost function is computed and the parameters are adjusted with the negative gradient. The back propagation algorithm is adopted for this supervised learning method to adapt the ANFN model parameters (c_i^l, σ_i^l and \hat{y}^l) based on the objective function. The adaption equations for parameters (c_i^l and σ_i^l) are described before in (5). By following the same sequence, the equation for adapting parameter w is derived as shown in (11 and 12).

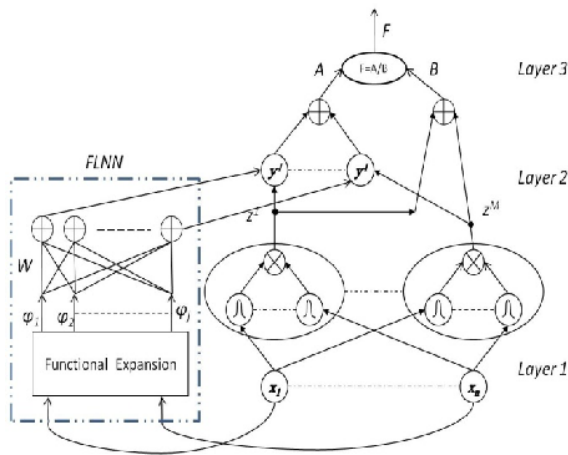

Fig. 8 ANFN structure

$$w_{ij}(k+1) = w_{ij} - \alpha_w \frac{\partial E}{\partial w_{ij}} \quad (11)$$

$$\frac{\partial E}{\partial w_{ij}} = e \left(\frac{b \varphi_M}{z^l} \right) \quad (12)$$

where α_w is the learning rate parameter of the FLNN weight and $E(k)$ is error between the fuzzy model and the actual plant outputs.

In this study, both the link weights in the consequent part and the parameters of the membership functions in the precondition part are adjusted by using the back propagation algorithm. Each degree of freedom of underwater vehicle dynamics is represented by one ANFN model. Therefore, there are six SISO ANFN models to represent six degree of freedom of AUV.

In the precondition part, the input is represented by five

Gaussian membership functions that mean five means and variance needed to be adapted. In the consequent part, the output is generated by FLNN. The function expansion in FLNN uses trigonometric functions, given by $[1, \hat{x}_1, \sin(\pi \hat{x}_1), \cos(\pi \hat{x}_1)]$ for one input variable. It leads to the of the weight variables, w , is (4×5) matrix needed to be adapted.

V. CONVERGENCE OF AUV MODEL

Each learning rate parameter of the weight, the mean, and the variance, α , has a significant effect on the convergence. To ensure a quick and stable convergence of fuzzy controller parameters a convergence analysis of the learning rate α will be considered according to the following theorem.

Theorem [19]: Let α be the learning rate for the parameters of fuzzy controller and g_{\max} be defined as $g_{\max} := \max_k \|g(k)\|$ where $g(k) = \delta y(k) / \delta z(k)$ and $\|\cdot\|$ is the usual Euclidean norm in \mathfrak{R}^n and let $S = \delta y_m / \delta u$. Then the convergence is guaranteed if α is chosen as;

$$0 < \alpha < \frac{2}{S^2 g_{\max}^2} \quad (13)$$

VI. SIMULATION RESULTS

A MATLAB program is conducted to simulate the dynamics of the AUV by using Runge-Kutta fifth order method with tolerance 0.00001. The same fuzzy controller is applied on mathematical model, adaptive fuzzy model and ANFN model.

Fig. 9 and Fig. 10 show the motion of the AUV in square trajectory in XY plane and in straight-line motion in XZ respectively. It is seen that the motion of the AUV with ANFN model does a better job compared to the performance of the AUV with adaptive fuzzy model in terms of accuracy as well as the speed.

Fig. 11, Fig. 12 and Fig. 13 provide an example of the performance of ANFN model and its tracking capability of the mathematical model. These figures show the angular velocity in pitch motion, q , the error between the mathematical and adaptive fuzzy model, and the error between the mathematical and ANFN model in that motion respectively. It is clearly seen that the behaviour of the ANFN model has similar behavior as the mathematical model. The ANFN system identification has the capability to track the plant successfully whatever the change in the operating conditions.

The learning rates, for all models were initially set to 1 to train the model parameters. Then the convergence conditions were verified at every sampling time. In the present work, it was found that of "1" value was always within the limit of convergence for the fuzzy model and in the range 0.009 to 0.236 for FLNN parameters in ANFN model.

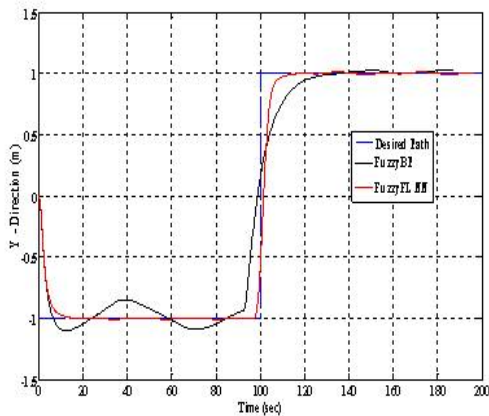

Fig. 9 AUV square motion in XY plane with ANFN model and fuzzy model based on fuzzy control

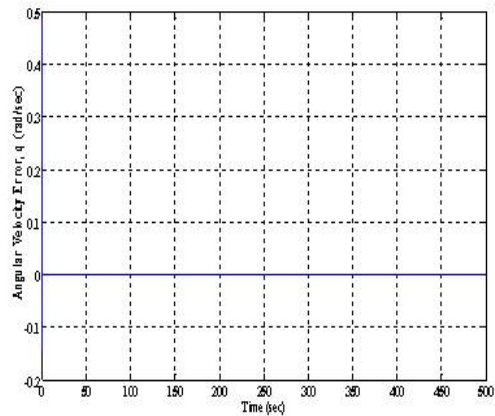

Fig. 12 The error between mathematical model and adaptive fuzzy model in q

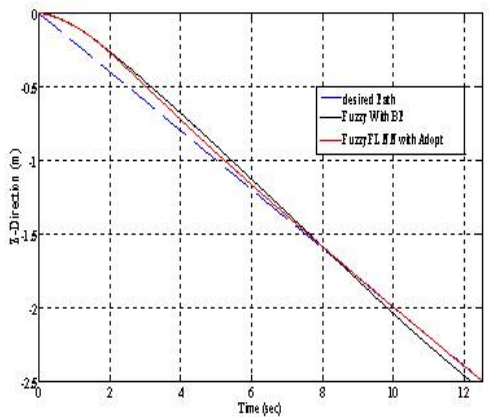

Fig. 10 AUV motion in XZ plane with ANFN model and fuzzy model based on fuzzy control

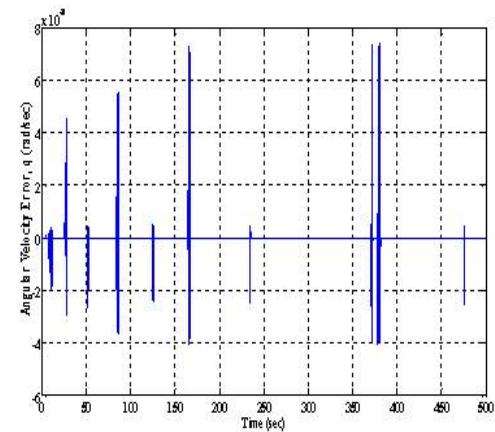

Fig. 13 The error between mathematical model and ANFN model in q

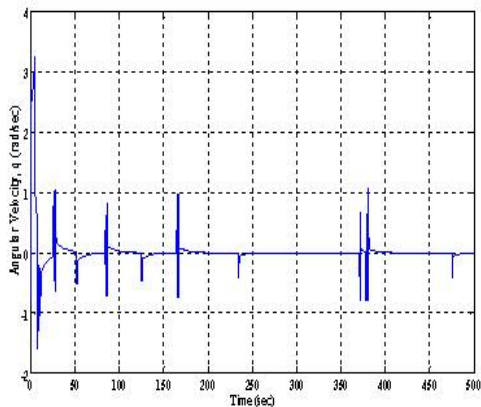

Fig. 11 The actual pitch angular velocity of the mathematical model, q

A. Open Loop Accuracy Evaluation of AUV Model

The most widely used method for measuring performance and the accuracy indicators of the AUV system is the root mean square error (RMSE). The root mean square error is defined as:

$$RMSE = \left(\frac{1}{n} \sum_{i=1}^n d_i^2 \right)^{1/2} \quad (14)$$

where n is the number of data pairs and d_i is the difference between i th desired and measured values, which means, it is the error between actual data that generated by the mathematical model and data that generated by the identified model.

The RMSE is said to provide information on the short-term performance of a model by allowing a term-by-term comparison of the actual difference between the desired value and the measured value. The smaller the value is, the better the model's performance.

Table I shows the RMSE values of the modeling error in velocity in each degree of freedom. Those errors are the error between the actual velocities generated from the mathematical model and velocities generated from both models (ANFN, fuzzy) while trying to track and model the original one.

Same operating conditions have been applied on all models. Generally, it is clear that the performance of the ANFN model is more accurate and more effective for identifying the mathematical model rather than fuzzy model.

It is obviously seen from the RMSE values for errors in q and r that the ANFN model has more flexibility in identifying, modeling and tracking the nonlinear and dynamics for q and r more than adaptive fuzzy system.

TABLE I
 THE RMSE VALUES FOR AUV ANFN MODEL AND FUZZY MODEL IN EACH VELOCITY COMPONENT

Velocity Error	ANFN Model with FLNN	Fuzzy Model with BP
u	6.6162e-004	4.0067e-004
v	8.6219e-005	3.9190e-004
w	2.5028e-006	1.7111e-004
q	2.7449e-004	0.0130
r	4.6631e-004	0.0017

VII. CONCLUDING REMARKS

The paper presents the numerical simulation results of the online adaptive fuzzy modelling and online adaptive neural fuzzy network (ANFN) as system identification of the mathematical modelling of the AUV using fuzzy controllers.

System identification with the ANFN with FLNN structure is found to be quite effective for the coupled nonlinear, six degree of freedom dynamic model. Performance comparison between an adaptive fuzzy and ANFN structure in terms of computational complexity and modeling error between the plant and model outputs has been carried out. It is shown that the overall performance of a suitably chosen ANFN structure is superior to an adaptive fuzzy structure for identification of nonlinear dynamic systems.

Fuzzy modeling is used to identify the model of the AUV using input-output data. The back propagation as a training algorithm for the fuzzy system proves the fast convergence of the fuzzy system and the fuzzy identifier successfully achieved a similar performance of the process.

REFERENCES

- [1] Wang, L.-X.; Mendel, J. M.: Back-Propagation Fuzzy System as Nonlinear Dynamic System Identifiers. In: Fuzzy Systems, IEEE International Conference, pp.1409-1418 (1992)
- [2] Bossley K. M.; Brown M.; Harris C. J.: Neurofuzzy identification of an autonomous underwater vehicle. In: J. International Journal of Systems Science, vol. 30, no. 9, pp. 901-913(1999)
- [3] Naeem, W.: Model Predictive Control of an Autonomous Underwater Vehicle. In: UKACC Conference control. Sheffield, IFAC, 19-23 (2002)
- [4] Citeseerx, <http://citeseerx.ist.psu.edu/viewdoc/download?doi=10.1.1.18.4.264&rep=rep1&type=pdf>.
- [5] Li-Xin Wang.: Stable adaptive fuzzy controllers with application to inverted pendulum tracking, In: Systems, Man, and Cybernetics, Part B: Cybernetics, IEEE Transactions on , vol.26, no.5, pp.677-691, (1996)
- [6] Y. H. Pao, S. M. Phillips, and D. J. Sobajic, "Neural-net computing and intelligent control systems," *Int. J. Control*, vol. 56, no. 2, pp. 263-289, 1992.

- [7] C. H. Chen, C. J. Lin, and C. T. Lin, "A functional-link-based neuro-fuzzy network for nonlinear system control," *IEEE Trans. Fuzzy Syst.*, vol. 16, no. 5, pp. 1362-1378, Oct. 2008.
- [8] J.C. Patra, G. Panda, Adriaan van den Bos, Modeling of an intelligent pressure sensor using functional link artificial neural networks, *ISA Transactions* 39 (2000) 15-27.
- [9] Fossen, Thor I.: Guidance and control of ocean vehicles. Wiley , New York (1994)
- [10] Asokan T.: Mathematical Modelling and Simulation of Autonomous Underwater Vehicle. Technical Report, IIT Madras (2007)
- [11] Wang, L. X.: Fuzzy System are Universal Approximators. In: IEEE Proceeding of International Conference on Fuzzy Systems, pp. 1163-1170 (1992)
- [12] Takagi, T., & Sugeno, M.: Fuzzy Ident of Sys & its Applic to Modelling & Control. In: IEEE Trans. on Syst, Man and Cyb, vol 15, pp. 116-1 32 (1985)
- [13] Akkizidis, I.S.; Roberts, G.N.: Fuzzy modelling and fuzzy-neuro motion control of an autonomous underwater robot. In: Advanced Motion Control, AMC '98-Coimbra., 5th International Workshop, pp.641-646 (1998)
- [14] Hassanein, O.; Anavatti, S.G.; Ray, T.; , "Fuzzy modeling and control for Autonomous Underwater Vehicle," *Automation, Robotics and Applications (ICARA)*, 2011 5th International Conference on , vol., no., pp.169-174, 6-8 Dec. 2011
- [15] Li-Xin Wang. Adaptive Fuzzy System and Control, Design and Stability Analysis. Prentic Hall, New Jersey (1994)
- [16] Shaaban A. S, Sreenatha G. A., Jin Y. C.: Indirect Adaptive Fuzzy Control of Unmanned Aerial Vehicle. In: Proceedings of the 17th World Congress, The International Federation of Automatic Control, pp. 13229-13243, Seoul, Korea, (2008)
- [17] Chen, Y.C. and C.C. Teng.: A Model Reference Control Structure Using a Fuzzy Neural Network. *J. Fuzzy Sets and Systems*, vol.73, pp. 291-312 (1995).