

Modular Hybrid Robots for Safe Human-Robot Interaction

J. Radojicic, D. Surdilovic and G. Schreck

Abstract—The paper considers a novel modular and intrinsically safe redundant robotic system with biologically inspired actuators (pneumatic artificial muscles and rubber bellows actuators). Similarly to the biological systems, the stiffness of the internal parallel modules, representing 2 DOF joints in the serial robotic chains, is controlled by co-activation of opposing redundant actuator groups in the null-space of the module Jacobian, without influencing the actual robot position. The decoupled position/stiffness control allows the realization of variable joint stiffness according to different force-displacement relationships. The variable joint stiffness, as well as limited pneumatic muscle/bellows force ability, ensures internal system safety that is crucial for development of human-friendly robots intended for human-robot collaboration. The initial experiments with the system prototype demonstrate the capabilities of independently, simultaneously controlling both joint (Cartesian) motion and joint stiffness. The paper also presents the possible industrial applications of snake-like robots built using the new modules.

Keywords—bellows actuator, human-robot interaction, hyper-redundant robot, pneumatic muscle.

I. INTRODUCTION

AN increasing interest for development of human-friendly collaborative robots, capable of interacting directly with the human through physical contact, has considerably changed widely established robot design paradigm: “design for precision/control for safety” towards the new one: “design for safety/control for precision”. A crucial issue in developing intrinsically safe interactive robotic systems addresses the realization and control of compliant robot behavior in physical contact with an environment or a human being. A critical problem in conventional industrial robots concerns the adjustment of the robot spatial end-point compliance (i.e. stiffness) to the specific environment and application requirements, in order to stabilize interaction and complete a given task [1]. In the last two decades, numerous interaction control techniques (comprehensive reviews are presented in [1, 2]) have been developed for applications with industrial robots, mainly with the goal to either realize simple passive admittance robot behavior (impedance control), or to control the force of interaction (force control) actively. The majority of high-performance algorithms utilize force sensors attached

to the end-effector in order to measure interaction forces directly. Applied in common industrial robotic systems, this approach has recently been proven to be unsafe for the interaction with both human beings and the environment [3]. Human- and environment-friendly robots should interact using not only the end-effector but also the entire arm body and surface (“whole arm manipulation”). This requires more sophisticated whole body compliance control and sensing approaches. A simple way to realize a whole body compliant system is to adjust the robot joint stiffness. Recently, various concepts for new robot joints with variable passively adjustable or actively controlled stiffness have been developed [4-6]. The critical issue, however, is still the management of two opposing requirements concerning accurate positioning and compliance control, which impose reasonably different conditions on the joint stiffness.

This paper presents a novel approach to the development of modular, safe and redundant robotic systems with modules built using biologically inspired actuators with non-linear force/contraction (i.e. extraction) characteristics. Similar to biological systems, the internal module (i.e. robot joint) stiffness is controlled by co-activation of opposing redundant actuator groups in the null-space of the robot Jacobian, without influencing the actual robot position. The decoupled position/stiffness control allows the realization of various stiffness force-displacement (i.e. torque-rotation) relationships. The initial experiments with the system prototype demonstrate the capabilities of independently, simultaneously controlling both joint (Cartesian) motion and joint stiffness.

II. BIOLOGICALLY INSPIRED ACTUATORS

The new robotic modules utilize pneumatic muscles (PMAs) and pneumatic bellows actuators (PBAs).

The main advantages of PMAs are: a very high power/mass (volume) ratio, low weight, physical flexibility, internal compliance, dynamic response, low cost, easy maintenance, and so forth. The relative contraction of PMAs amounts to about 30%, which is comparable to biological muscles. However, the specific contraction force is significantly higher, about 300 N/cm² compared to 20-40 N/cm² in biological muscles. Another interesting attribute of PMA technology is its inherent compliance. From the view of precise positioning, this feature may be deemed a drawback. However, considering the control of the interaction with an environment or a human being, the natural compliance of muscles is

Jelena Radojicic, Dragoljub Surdilovic and Gerhard Schreck are with the Fraunhofer Institute for Production Systems and Design Technology (IPK), Department Automation and Robotics, Pascalstraße 8-9, 10587 Berlin, Germany (phone: +493039006172; fax: +49303911037; e-mail: jelena.radojicic@ipk.fraunhofer.de).

advantageous for stabilizing the interaction. Therefore, PMAs have recently found attractive applications in interactive robotic devices that can objectively examine, enhance or replicate complex human musculo-skeletal movements, as well as apply therapeutic manipulations (e.g. human enhancers, haptic systems, active orthosis, rehabilitation robots, etc.).

Pneumatic bellows actuators (PBAs) have recently extensively been applied as an active damper, i.e. shock and vibration absorbers in automotive suspension systems and production machines. However, they are seldom used as servo-drives. The main difference with PMAs is that bellows can extract only with a considerably higher extension ratio (up to 100%) and actuating force magnitude.

The main difficulty inherent in PMA and PBA technology is the highly nonlinear and variable characteristics which require complex control algorithms and sophisticated control design in order to achieve high system performance. Since PMAs and PBAs can only realize contractive or extractive motions, respectively, the actuation of each system's degrees of freedom requires actions from multiple actuators which are in general, as in the case of natural muscles, interconnected by complex chains providing agonist-antagonist actions. The resolution of this redundant behavior complicates the control further.

III. MODULE STRUCTURES

For the development of the modules with PMAs and PBAs a simple parallel robot structure (Fig. 1) with two degrees of freedom (the axial rotation DOF of the Cardan joint K is fixed) is selected. This configuration allows a small and compact design of modules. On the other hand, this structure is compatible with a relatively limited range of possible drive displacements. Considering the unilateral working principle of PMAs and PBAs, at least three actuators are needed in order to realize and keep stable a pose of the platform defined by Cardan rotation angle around the local x and y axes (φ_x and φ_y , respectively).

In order to obtain the platform joint position, it is practical to measure the lengths of the muscles and bellows, i.e. the distances between selected points at the robot base and the platform. This measuring approach is sensitive to the errors in the construction, which is especially critical in the developed muscle module prototype that has been designed as simply as possible, without the complex Cardan joints required in rigid parallel robotic structures (the required degrees of freedom have been realized in a simple way utilizing muscle tension and uncomplicated ring connections, see Fig. 2). Therefore, the sensors (two linear variable differential transformers LVDT) have been attached directly to the module base (i.e. a parallel plate) and platform using a built-in spherical joint according to the principle of (Fig. 1, left), see (Fig. 2). The PBA prototype has been realized to meet high industrial application demands and includes precise Cardan joints at connections with platforms. In this case the LVDT sensors are directly attached between the bellows attachment plates (Fig. 1, right).

For controlling the pressure in the actuators, proportional control valves have been applied (Rexroth ED02 and ED05 pressure regulators). The attachment points at the robot base and the platform have been determined to reach maximum rotation angles and specific conditions related to the control of the module tension ("joint stiffness"). The arrangements and connection points of the PMAs and PBAs have been determined by means of an optimization procedure that will be explained below. It should be mentioned that due to the smaller contraction ratio of muscles (max. 30%) in comparison with the bellows' relative extraction (100%), the length of the PMAs module is considerably higher for the same platform rotational range (see Fig. 2, right).

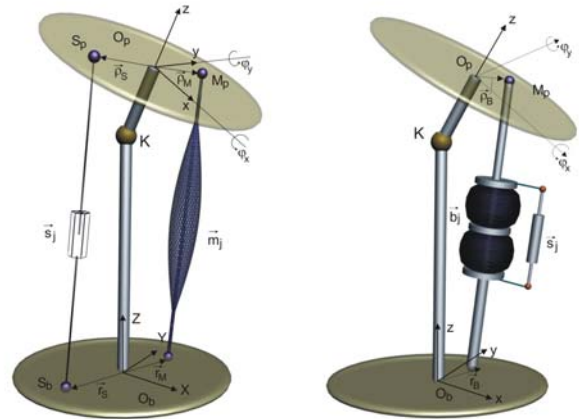

Fig. 1 PMA and PBA module structures

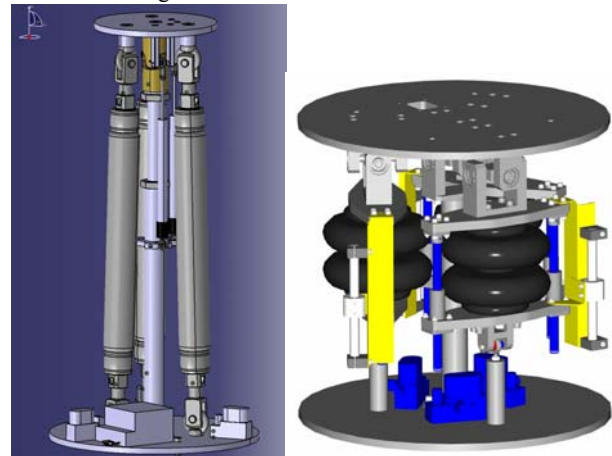

Fig. 2 Modules design

IV. MATHEMATICAL MODELS

The kinematic and dynamic models of the modules can be obtained based on procedures well investigated for the parallel robots [7]. The inverse kinematics problem for the considered structures with both muscles and bellows (Fig. 1) is simple to solve and, using the notations from (Fig. 3), can be expressed in the form

$$\vec{m}_i = -\vec{r}_{M_i} + \vec{l}_K + \mathbf{R}(\varphi_x, \varphi_y) \cdot (\vec{l}_P + \vec{\rho}_{M_i}) \quad (1)$$

where \vec{m}_i is the vector of the i-th actuator's length, $i=1 \dots 3$, $\mathbf{R}(\varphi_x, \varphi_y)$ is the rotation matrix of the platform, and the

remaining vectors are defined in (Fig. 3). (“~” denotes the vectors in the local platform coordinate frame). For the structures in (Fig. 1, 2) and selecting a specific attachment of the linear sensors along two orthogonal axes in the base and platform planes (Fig. 3), respectively, the direct kinematics of this module can also be solved in the closed form

$$(\varphi_x, \varphi_y) = \tilde{f}(s_1, s_2, \tilde{r}_{M_i}, \tilde{l}_p, \tilde{\rho}_{M_i}) \quad (2)$$

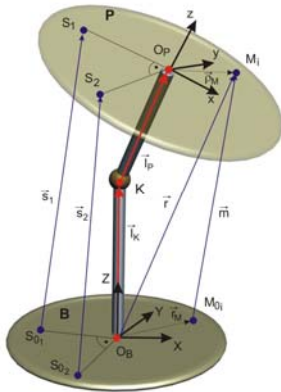

Fig. 3 Modules model

However, for the structure in (Fig. 1, right) with arbitrarily arranged bellows and associated linear sensors, a numerical iterative procedure must be applied based on the Jacobian matrix of the parallel robot module, which maps external platform angular velocities (i.e. incremental angular displacements) to linear actuator velocities (displacements). For the considered parallel robot structures in (Fig. 1), the relationship between the rates of change of the external and internal coordinates may be expressed in the form

$$\Delta \bar{m} = \mathbf{A}^{-1} \mathbf{B} \mathbf{C} \Delta \bar{c} = \mathbf{J}_m \mathbf{C} \Delta \bar{c} = \bar{\mathbf{J}}_m \Delta \bar{c} \quad (3)$$

Here $\bar{m} = [m_1 \ m_2 \ m_3]^T$ is the actuator length vector, and

$\bar{c} = [\varphi_x \ \varphi_y]^T$ is the Cardan angle vector. The 3x2 Jacobian matrices \mathbf{J}_m and $\bar{\mathbf{J}}_m = \mathbf{J}_m \mathbf{C}$ map platform angular velocities and the Cardan angle derivatives to actuator linear velocities, respectively. The 3x3 matrices \mathbf{A} and \mathbf{B} have the form

$\mathbf{A} = \text{diag}(m_i)$ and $\mathbf{B} = [\bar{b}_1 \ \bar{b}_2 \ \bar{b}_3]^T$, where

$$\bar{b}_i = (\tilde{l}_p + \tilde{\rho}_{M_i}) \times (-\tilde{r}_{M_i} + \tilde{l}_k) \quad (4)$$

and the above vectors are as indicated in (Fig. 3). The 3x2 matrix \mathbf{C} interrelates angular and Cardan angle velocities

$$\mathbf{C} = \begin{bmatrix} 1 & 0 & 0 \\ 0 & \cos \varphi_x & \sin \varphi_x \end{bmatrix}^T \quad (5)$$

From (3) we can determine the rates of change of the platform angles for the known actuator contraction (extraction)

$$\Delta \bar{c} = \bar{\mathbf{J}}_m^{-T} (\bar{\mathbf{J}}_m \bar{\mathbf{J}}_m^{-T})^{-1} \Delta \bar{m} \quad (6)$$

The above equation provides the basis for an iterative

numerical direct kinematics solution procedure which also utilizes the closed form inverse kinematics solution (1). The quasi-static model defines the relationship between the internal actuator forces and external torques applied to the platform

$$\bar{\mathbf{F}}_m \cdot \delta \bar{m} = \bar{\mathbf{M}}_{ext} \cdot \delta \bar{\omega} \quad (7)$$

where $\delta \bar{\omega}$ describes incremental virtual platform rotation around an equilibrium pose. Based on (3) this relation can be rewritten as

$$\mathbf{M}_{ext} = \hat{\mathbf{J}}_m^T \mathbf{F}_m \quad (8)$$

where $\hat{\mathbf{J}}_m$ is the 3x2 submatrix of \mathbf{J}_m formed by deleting the last column of \mathbf{J}_m (taking into account the fixed rotational DOF of the Cardan joint around the z-axis). For the given external load \mathbf{M}_{ext} , the corresponding internal forces can be calculated from (8)

$$\mathbf{F}_m = \hat{\mathbf{J}}_m^T \neq \mathbf{M}_{ext} + (\mathbf{I} - \hat{\mathbf{J}}_m^T \hat{\mathbf{J}}_m^T \neq) \mathbf{y} = \quad (9)$$

$$\hat{\mathbf{J}}_m^T \neq \mathbf{M}_{ext} + \lambda \mathbf{N}(\hat{\mathbf{J}}_m^T)$$

where $\hat{\mathbf{J}}_m^T \neq$ denotes pseudo inverse of the Jacobian $\hat{\mathbf{J}}_m^T$

$$\hat{\mathbf{J}}_m^T \neq = \hat{\mathbf{J}}_m (\hat{\mathbf{J}}_m^T \hat{\mathbf{J}}_m)^{-1} \quad (10)$$

\mathbf{y} and λ are an arbitrary 3x1 vector and a parameter, respectively, and $\mathbf{N}(\hat{\mathbf{J}}_m^T) \in \ker(\hat{\mathbf{J}}_m^T)$ is 3x1 vector in the null-space of $\hat{\mathbf{J}}_m^T$. The above equations mean that due to module redundancy (two DOFs are realized by 3 drives with unilateral actions), external torques cannot be uniquely distributed on the actuators: it is possible to utilize one redundant DOF to adjust the opposing internal module forces along the Jacobian null-space without affecting the equilibrium of the torques/forces (9). In this way, an adaptation of internal module tension, i.e. platform joint rotational stiffness, can be realized.

In order to ensure a positive tensile/pressing strength of the muscle/bellows module within the working space of the platform independently of the external load, the elements of $\mathbf{N}(\hat{\mathbf{J}}_m^T)$ must have the same sign in the entire working space. This ensures tension distribution among all actuators within the module according to (9). The realization of this condition is one of the relevant module design requirements. It should be ensured by a corresponding selection of actuator attachment points affecting the module Jacobian (3-5). Furthermore, good Jacobian conditioning is required to minimize internal actuator forces and increase the module manipulability. In order to uniformly distribute the tension among the actuators, it is desirable that the null-vector components are approximately uniform. Thus the design objective becomes

$$w_1 \max(\text{cond}(\hat{\mathbf{J}}_m^T)) + w_2 \min(\text{null}(\hat{\mathbf{J}}_m^T)) + \quad (11)$$

$$w_3 (\max(\text{null}(\hat{\mathbf{J}}_m^T)) - \min(\text{null}(\hat{\mathbf{J}}_m^T))) \Rightarrow \min$$

where w_i ($i=1, \dots, 4$) are weightings factors.

The module dynamics models can be derived based on

well-known procedures for parallel robots [7] and due to limited space will not be considered. It is worth mentioning that the muscles and bellows are lightweight drives and their inertial effects can be neglected in the dynamic models.

V. MODULE CONTROL

For the module control design it is essential to know, beside the dynamics of the modules, also the dynamic models of the pneumatic drives. The attractive performance of PMAs has influenced considerable research efforts of late focusing on the modeling and control of PMAs. The main difficulty is presented by the non-linear nature of the PMAs, making the mathematical modeling based on physical laws to be quite complex. Moreover, diverse types of PMAs (detailed surveys of different PMAs are given in [8, 9]) complicate the modeling. Physical models of rubber bellows actuators appear to be even more complex than the models of PMAs. Unfortunately, unlike with PMAs, investigations of PBA models are still in an initial state. Therefore, simplified models taking into account experiments have found practical importance.

In general, the muscle force is a non-linear function of contraction, load, pressure and velocity. In order to analyze the force in terms of the multidimensional set of parameters, standard tests are performed: isometric, isotonic or isokinetic. Isometric experiments with variable contraction provide an approximately linear force/pressure relationship with negligible hysteresis during air charge/discharge. These results allow complex multidimensional muscle characteristics to be simplified to an utilizable two-dimensional relationship between the force/pressure ratio and contraction [10] (Fig. 4).

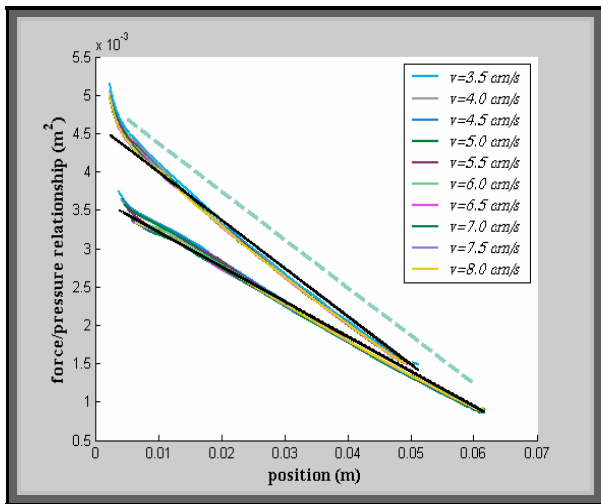

Fig. 4 Isometric and dynamic force/pressure ratio in terms of muscle contraction

A linear law can also correctly approximate this relation. Thereby, the upper limit for the attainable force/pressure ratio values is obtained in isometric tests (dashed line in Fig. 4), while the dynamic test limits with various velocities are placed below this limit. The thicker colored lines illustrate small damping effects at various velocities.

Based on the above experiments, a quite practical mathematical model of a PMA can be derived. The

force/pressure ratio (F/p) has the physical meaning of an area referred to as the “equivalent virtual muscle area.” This approximation permits the modeling of the actuating force by analogy with pneumatic cylinders. However, in PMAs this “equivalent piston area” is variable (decreasing) with the displacement (muscle contraction). The physical meaning of the “virtual muscle area” can be obtained based on a simplified energy conservation law, taking into account only the mechanical and internal air pressure energy:

$$F_m dm = p dV \quad (12)$$

$$F_m / p = dV / dm = \partial V(m) / \partial m$$

where V is the inner volume of the muscle. Neglecting the elastic effects of the muscle tube and sleeve, it is convenient to assume V to depend merely on the muscle length. The above equation yields

$$F_m(p, \Delta m) = p A_m(\Delta m) - F_{om}(\Delta m) \quad (13)$$

where the volume change with the contraction represents the “virtual muscle area” $A_m(\Delta m)$ which, based on (Fig. 5), can be approximated by a linear function of Δm ($A_m(\Delta m) = a_1 \Delta m + a_0$). The internal force corresponds to the pressure work needed to compensate internal muscle deformation forces for an actual muscle contraction Δm . Furthermore, this model can be simplified by adopting one “equivalent area” which covers all working conditions [10]. It is reasonable to approve the upper limit, i.e. “isometric force/pressure” ratio and the “isometric virtual area” as muscle characteristics. The parameters of the model (13) for the used FESTO muscles can be determined using the muscle data or estimated by means of relatively simple reliable experiments, which provide

$$A_m(\Delta m) = -0.1080 \Delta m + 0.0096 \quad (14)$$

$$F_{om}(\Delta m) = -5.7999 \cdot 10^6 \Delta m^3 + 0.7802 \cdot 10^6 \Delta m^2 - 0.0335 \cdot 10^6 \Delta m$$

This approximation provides a rather conservative, nevertheless practical result. A similar experimental analysis of the performance of bellows actuators is the topic of actual research.

The simplified models (13-14) allow determining the stiffness of the pneumatic actuators. Adopting a linear stiffness law and neglecting the nonlinear muscle effects (e.g. air and muscle compressibility), considering small virtual displacement around an equilibrium muscle state

$$F_m + \delta F_m = (p + \delta p)(A + \delta A) \quad (15)$$

and assuming an ideal pressure valve control compensating for pressure variations, yields

$$\delta F_m = K_m \delta m \quad (16)$$

$$K_m = p a_1$$

where K_m denotes muscle drive stiffness. The above equations imply that the stiffness of the pneumatic drives can be adjusted by air pressure.

The established models were further applied to the control synthesis. The entire control output includes the local actuator

position controller u_i , the feed-forward control u_{ff} compensating for the module dynamic effects (inertia, gravitation, centrifugal and Coriolis torques) and the tension (actuator stiffness) controller u_t realizing a given tension based on (9-10, 16) (Fig. 5). These control signals represent scaled equivalent muscle forces. A simplified non-linear decoupling approach using a model of muscles (12-13) has been applied to obtain corresponding control valve inputs.

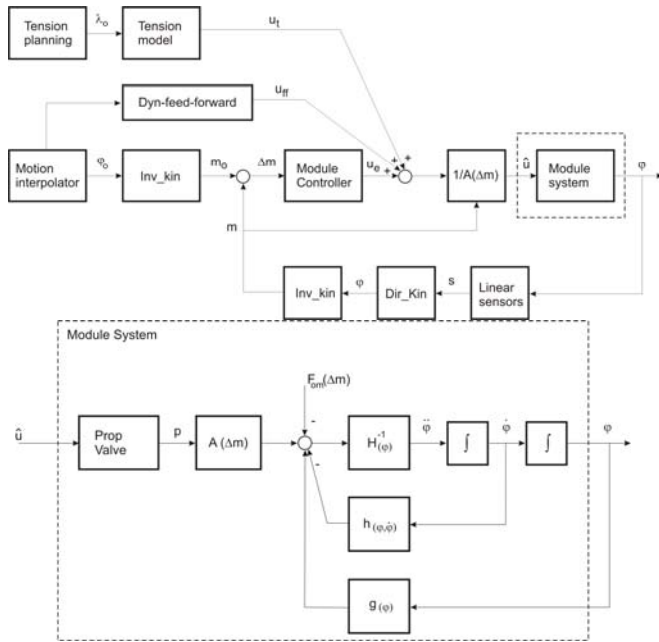

Fig. 5 Muscle module control scheme

In the bellows modules, missing knowledge of bellows dynamics prevented us from implementing a similar dynamic control scheme. Therefore, a simplified robust PID compensator was synthesized based on catalogue characteristics (for FESTO bellows) and implemented. The initial tests demonstrate accurate regulation of a given pose and relatively good tracking of angular trajectories (Fig. 6). Obviously, the achieved bandwidth with the first prototype is considerably low (about 1 Hz), taking into account relatively the low bandwidth of the drives, high prototype inertia and small air flow in used valves (ca. 200 l/min). With higher mass-flow valves (with 1000 l/min), the system response was significantly faster, up to 4 Hz, which is enough for controlling human-robot interaction.

The control of the internal module tension is based on (7-10). The control output u_t is obtained based on the rate of change of the factor λ according to

$$\Delta F_{men} = \Delta \lambda \mathbf{N}(\hat{\mathbf{j}}_m^T) \quad (15)$$

$$u_t = k_v \Delta F_{men} / A_m(\Delta m)$$

where k_v is a scaling factor. Since the tension adjustment (i.e. the internal module stiffness adaptation) is realized in the Jacobian null-space, it doesn't affect the position control nominally. However, due to model errors, the variations of the control inputs in the null-space position control causes position disturbances that are compensated for by the local control. The feed-forward tension term u_t (Fig. 5) is

proportional to the stiffness variation ΔK_m corresponding to the tension adjustment factor $\Delta \lambda$.

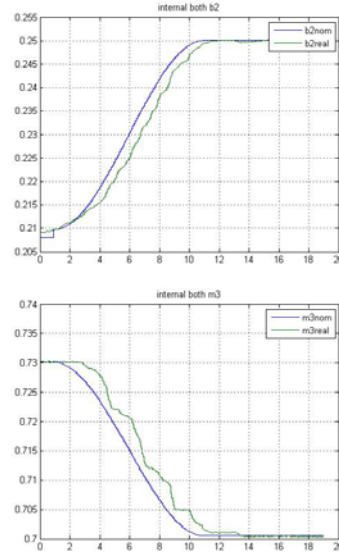

Fig. 6 Tracking example of internal bellows/muscles trajectory during the emotion

VI. HYBRID ROBOT STRUCTURES

Interconnecting several modules (by connecting the base of the following module to the platform of the previous one) provides high redundant snake-like robotic structures (Fig. 7). The obtained robotic structure represents a serial chain of parallel robot modules, a so-called hybrid serial-parallel robot structure. These structures combine the advantages of both configurations and are recently the focus of research efforts. An efficient approach to modeling the structures built with the developed modules is to neglect actuator relative dynamics (due to relatively small inertia), and to decompose the platform (module) DOFs into a virtual connection of two serial links, one corresponding to the axis φ_x with zero length and inertia, and the second associated to the axis φ_y . This approximation significantly simplifies the modeling, and existing algorithms for kinematic and dynamic simulations of serial robots may be applied.

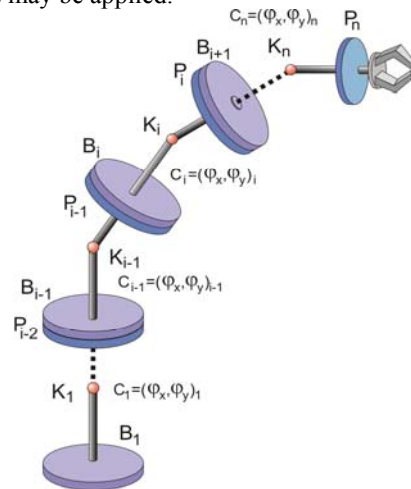

Fig. 7 High redundant snake-like robotic structures

The details about kinematic models, including inverse (complicated for serial part to map Cartesian poses into module joint positions and requiring numerical solutions using serial arm Jacobian, however, trivial for parallel modules and mapping of joint positions into muscle lengths) and direct problems (with vice versa complexity to the previous problem), as well as direct dynamics (used to compute feed-forward control Fig. 5), are omitted due to limited space.

VII. HYBRID ROBOT PROTOTYPE

The first hybrid robot prototype includes 3 modules: two bellows and one muscle-actuated module (Fig. 8). The initial experiments with this prototype proved the feasibility of the developed approach with relatively satisfying performance in tracking trial of relatively simple and slow Cartesian trajectories (a linear path with max. 0.2 m/s). Thereby, an accuracy of about 0.01 m was achieved. Regardless of these unfavorable results, especially in comparison to standard industrial robots, the first prototype clearly demonstrated the advantages of the novel concepts: foremost, the contact tasks and an intrinsically safe interaction with a human being (Fig. 9) even during the collision (whole arm manipulation).



Fig. 8 Hybrid structure composed of 3 modules

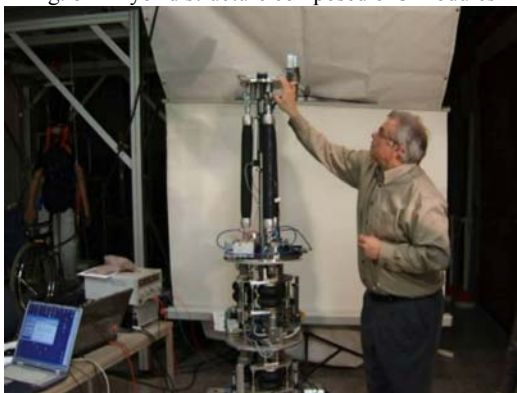

Fig. 9 Safe whole arm interaction

Some of the identified potential future applications of the novel robot structures require at least 8-12 modules, e.g. for the inspection of not easily accessible areas, as well as for

human-robot cooperation in assembly (Fig. 10). In general, due to a relatively low reachable bandwidth (1-2 Hz), the application of these robots is advantageous for non-time-critical tasks, usually performed by a human being, and in complex environments.

The critical problem concerned with the new robotic structures is referred to the loss or switch-off of pressure (e.g. during commissioning, maintenance etc.) in pneumatic actuators that requires complicated braking systems in Cardan joint to fix the robot structures, which considerably increases costs of the system. To cope with this problem in an efficient way it is promising to hang the robot on the ceiling. Furthermore, to achieve system mobility, the robot base may be attached to a rail crane. The climbing structures with grippers on both ends (caterpillar robots) and ability for docking at special anchor-points providing energy and control-communication interfaces, is the topic of current research (Fig. 11).

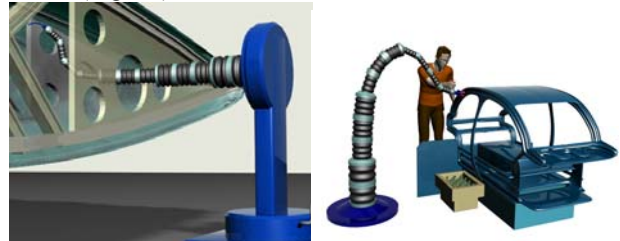

Fig. 10 Potential applications

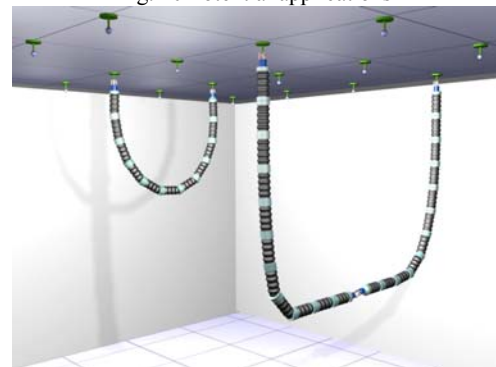

Fig. 11 Collaborative climbing "active caterpillars"

VIII. CONCLUSION

The paper presents a novel approach to developing high modular hybrid robot systems with adaptable compliance based on biologically inspired actuators: artificial pneumatic muscles and pneumatic bellows actuators. The main benefits of this system include: its low cost (less than 1,500 USD per module), reconfigurability and flexibility, as well as its intrinsically safe interaction with the environment.

The forthcoming research focuses on an improvement of the system control performance and bandwidth based on increased knowledge of PBA dynamics. This is also related to the enhancement of vibration damping performance. In order to improve end-effector positioning accuracy (according to the novel human-friendly robot development paradigm: "design for safety and control for accuracy"), it is promising to integrate external sensors (e.g. IMUs, cameras, etc.)

compensating for errors along the kinematics chain. A practical problem also concerns efficient structure interlocking (switch-off). The task specific planning of high-redundant system motion, compliance and interaction control based on biomimetic algorithms is also a topic of future investigations.

REFERENCES

- [1] Vukobratović M., Surdilović D., Ekalo Y., Katic D., Dynamics and Robust Control of Robot-Environment Interaction, World-Scientific, New-Jersey, 2009.
- [2] Chiaverrini S., Siciliano B., Villani L., 1999, *A Survey of Robot Interaction Control Schemes with Experimental Comparison*, IEEE/ASME Trans. on Mechatronics, Vol. 4, No. 3, 273-285.
- [3] Sami Haddadin, Alin Albu-Schäffer and Gerd Hirzinger: *The Role of the Robot Mass and Velocity in Physical Human-Robot Interaction - Part I: Unconstrained Blunt Impacts*, IEEE Int. Conf. on Robotics and Automation (ICRA 2008), Pasadena, USA, 2008.
- [4] Dongjun Shin, Irene Sardeliti and Oussama Khatib: *A Hybrid Actuation Approach for Human-Friendly Robot Design*, IEEE Int. Conf. on Robotics and Automation (ICRA 2008), Pasadena, USA, 2008.
- [5] Albu-Schäfer A., Eiberger O., Grebenstein M., Haddadin S., Ott C., Wimböck T., Wolf S. and Hirzinger G., : „*Soft Robotics*“, IEEE Robotics & Automation Magazine, September 2008, pp. 20-26.
- [6] Bicchi A., Tonni G., “*Fast and “Soft-Arm” Tactics*”, IEEE Robotics&Automation Magazine, June 2004, pp.22-33.
- [7] J. P. Merlet, *Parallel Robots (Solid mechanics and its Applications)*, 2nd ed., Springer-Verlag, 2006.
- [8] B. Tondu, V. Boitier, P. Lopez. Natural compliance of robot-arms based on McKibben artificial muscle actuators. In *European Robotics and Intelligent Systems Conference*, pp. 783-797, Malaga, 1994.
- [9] Daerden F., *Conception and Realization of Pleated Pneumatic Artificial Muscles and Their Use as Compliant Actuation Elements*, PhD. Thesis, Vrije, Universiteit Brussel, 1999.
- [10] Radojicic J., Surdilovic D. and Krüger J., “Control Algorithms of Pneumatic-Muscles Actuators in Complex Mechanical Chains”, CD Proc. III Int. Symp. on Adaptive Motion in Animals and Machines, AMAM'2005, Sep. 2005, Ilmenau, Germany, Abs. pp 44.