

A ZVS Flyback DC-DC Converter using Multilayered Coreless Printed-Circuit Board (PCB) Step-down Power Transformer

Hari Babu Kotte, Radhika Ambatipudi and Dr. Kent Bertilsson

Abstract—The experimental and theoretical results of a ZVS (Zero Voltage Switching) isolated flyback DC-DC converter using multilayered coreless PCB step down 2:1 transformer are presented. The performance characteristics of the transformer are shown which are useful for the parameters extraction. The measured energy efficiency of the transformer is found to be more than 94% with the sinusoidal input voltage excitation. The designed flyback converter has been tested successfully upto the output power level of 10W, with a switching frequency in the range of 2.7MHz-4.3MHz. The input voltage of the converter is varied from 25V-40V DC. Frequency modulation technique is employed by maintaining constant off time to regulate the output voltage of the converter. The energy efficiency of the isolated flyback converter circuit under ZVS condition in the MHz frequency region is found to be approximately in the range of 72-84%. This paper gives the comparative results in terms of the energy efficiency of the hard switched and soft switched flyback converter in the MHz frequency region.

Keywords—Coreless PCB step down transformer, DC-DC converter, Flyback, Hard Switched Converter, MHz frequency region, Multilayered PCB transformer, Zero Voltage Switching

I. INTRODUCTION

THE most essential unit required for all electronic devices is the Power Supply Unit (PSU). The requirement is to design a compact Switch Mode Power Supply (SMPS) to make it compatible with the majority of modern electronic equipment. The continuous efforts with regards to the improvement of switching devices such as MOSFETs and diodes has lead to the increased switching speeds of the power supplies. The switching devices, working at higher frequencies, causes the size of passive elements such as capacitors, inductors and transformers to be reduced and this results in the compact size, weight and the increased power density of the converter[1]. In addition, with the help of

Hari Babu Kotte is with the Department of Information Technology and Media, Mid Sweden University, SE-85170, Sundsvall, Sweden, (phone: +46-60148982; fax: +46-60148456; e-mail: Hari.Kotte@miun.se).

Radhika Ambatipudi is with the Mid Sweden University, Department of Information Technology and Media, SE-85170, Sundsvall, Sweden, e-mail: Radhika.Ambatipudi@miun.se).

Dr. Kent Bertilsson is with the Department of Information technology in Media, Mid Sweden University, and Sundsvall. Sweden, 85170(e-mail: Kent.Bertilsson@miun.se). He is also CEO and co-founder of SEPS Technologies AB, Storgatan 90, SE-85170, and Sundsvall, Sweden.

increased switching frequencies, the loop response of the power supply can be greatly enhanced. In the isolated converters such as flyback and forward, the switching frequencies are limited to less than 500 kHz because of the limitations of the existing core based transformers such as hysteresis and eddy current losses and also due to the increased switching losses of the Power MOSFET. Core based transformers have limitations such as magnetic saturation, core losses and, in addition, possess very bad high frequency characteristics because of the presence of magnetic cores [2]. In the late 1990s, research was concentrated on mitigating these limitations by using the coreless PCB transformers and their corresponding characteristics were presented in [3]. Recent investigation shows that the coreless PCB transformers can be used for signal and power transfer applications as mentioned in [4]. The transformers have however been limited to small voltage transformations as only the 1:1 transformers have shown sufficient efficiency. Here, the step-down transformer with a turn ratio of 2:1 have been developed enabling high frequency step down/up converters. The most widely used switch mode power supply topology for power applications of below 150W [5] is the flyback topology, which uses only a single magnetic element to act as a coupled inductor providing both the isolation and the energy storage. Its most attractive feature is that it requires no output inductors, whereas it is required by the remaining switching power supply topologies for filtering action. Thus, the consequent savings in both the cost and the size of the inductor forms a significant advantage in the flyback topology. The flyback converters appear in almost all modern low power equipments such as in computer monitors, laptop adapters, DVD players, set top boxes, telecom applications etc.,

In this paper, a low profile, low cost ZVS flyback power converter with a coreless step down (2:1) PCB transformer operated in MHz frequency region is presented.

II. STRUCTURE OF CORELESS PCB STEP DOWN POWER TRANSFORMER

A printed circuit board step down transformer is used and tested in the isolated flyback converter circuit for power transfer application. The primary and secondary windings of

the transformers are manufactured as three spirals in a four layered PCB laminate. The primary windings are split into layers 1 and 3 and externally connected to layer 4 where the secondary winding is sandwiched in between the two primary windings.

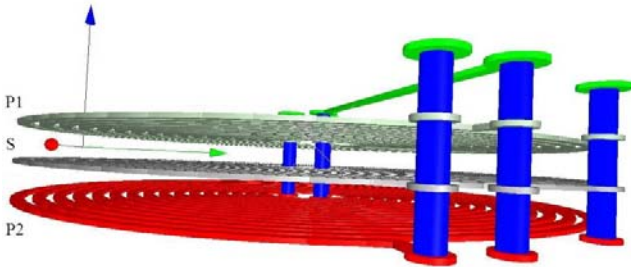

Fig.1 3D View of four layered 2:1 step down coreless PCB transformer

The PCB laminate of the transformer is FR4 material which has a breakdown voltage of 50kV/mm approximately [6]. The number of turns of the primary winding ' N_1 ' is 32 and for the secondary winding ' N_2 ' it is 16. The conductor width, separation and height are 0.6mm, 0.4mm and 70 μ m respectively. The outer diameter of the transformer is 36mm and the distance between the two consecutive layers of the PCB is 0.4mm.

III. PERFORMANCE CHARACTERISTICS OF THE CORELESS PCB STEP DOWN POWER TRANSFORMER

In this section, the resistive, inductive and capacitive parameters of the transformer are presented. The performance characteristics such as the transfer function $H(f)$ and the input impedance (Z_{in}) of the transformer with a resonant capacitor ' C_r ' of 820pF at a load resistance of 50 Ohms are measured. The initial parameters such as the primary self inductance ' L_p ', the secondary self inductance ' L_s ' and the resistances of the windings are measured with the assistance of an HP4284A precision LCR meter at 1MHz frequency by open circuiting the opposite winding of the transformer. The preliminary primary and secondary leakage inductances of the transformers are obtained by using the Four-wire measuring method [7]. The leakage inductances of the flyback transformers, which are less than 1 μ H, are obtained by using the following expression

$$L_{lk} = \frac{50}{2\pi f} \frac{V_{dut}}{V_{50\Omega}} \quad (1)$$

where L_{lk} is the leakage Inductance, ' f ' the excitation frequency, V_{dut} , the voltage across the device under test and $V_{50\Omega}$ is the voltage across the 50 Ω resistor. The actual parameters such as the leakage-, self- and mutual-inductance of the transformers are obtained by fitting measurements of the transfer function and the input impedance into the high frequency model of the transformer shown in fig. 2. The above measured parameters are used as initial values that are

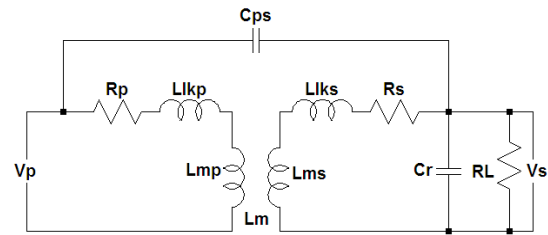

Fig.2. High frequency model of coreless PCB step down transformer

fine tuned to fit the measurement in the frequency range 1-10MHz and the final parameters are shown in table I. The measured and modelled performance characteristics of the transfer function $H(f)$ and the input impedance (Z_{in}) are shown in figs 3 and 4 respectively. The modelled performances are obtained from the high frequency equivalent model [3] with C_r of 820pF and R_L of 50 Ω and are in very good agreement with the measured ones, indicating that both the model and the parameter values are correct.

TABLE I

MODELLED PARAMETERS OF THE DESIGNED STEP-DOWN TRANSFORMERS

PARAMETERS		Values
$R_p(\Omega)$ -DC	Primary winding resistance	1.10 Ω
$R_s(\Omega)$ -DC	Secondary winding resistance	0.55 Ω
$L_p(\mu$ H)	Primary self inductance	17.23 μ H
$L_s(\mu$ H)	Secondary self inductance	4.54 μ H
$L_{lkp}(\mu$ H)	Leakage inductance of primary	0.46 μ H
$L_{lkps}(\mu$ H)	Leakage inductance of secondary	0.23 μ H
$L_m(\mu$ H)	Mutual inductance	8.5 μ H
$C_{ps}(\text{pF})$	Interwinding capacitance	68.0pF

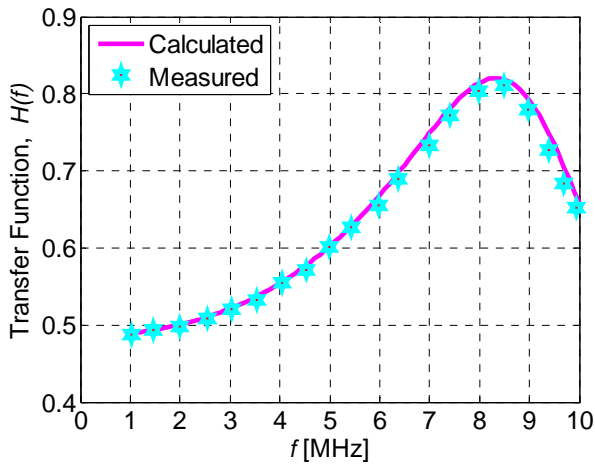

Fig. 3 Measured and modelled voltage gain of the coreless PCB step down transformer with $C_r=820\text{pF}$ and $R_L=50\Omega$

The intrawinding capacitances of the primary and secondary windings are very small and can be ignored in further analysis. From fig. 3 we can observe that the transfer function $H(f)$ of the coreless PCB step down transformer has a resonance at a frequency just above 8MHz, where the magnitude of $H(f)$ increases from 0.5 to 0.8.

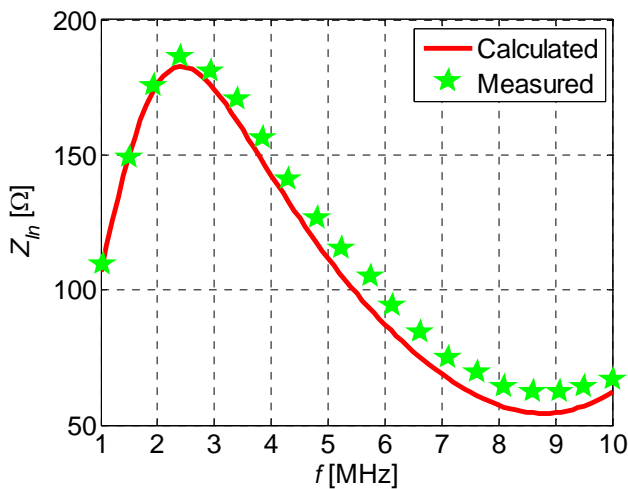

Fig. 4 Measured and modelled input impedance of the coreless PCB step down transformer with $C_r=820\text{pF}$ and $R_L=50\text{ Ohms}$

The input impedance of the transformer is sufficiently high in the frequency range of 1.5-4MHz and it has a maximum of about 180Ω at a frequency of 2.4MHz. The input impedance phase angle (ϕ) of the transformer is illustrated in fig. 5 and is highly inductive in the frequency range of 1-2MHz. Hence, the optimal operating frequency region of the transformer is 1-2MHz [4] and the transformer has higher input impedance and a highly inductive nature. Above 8 MHz the transformer again becomes inductive. However, it cannot be used efficiently in that range due to the low input impedance and increased ac resistance of the windings.

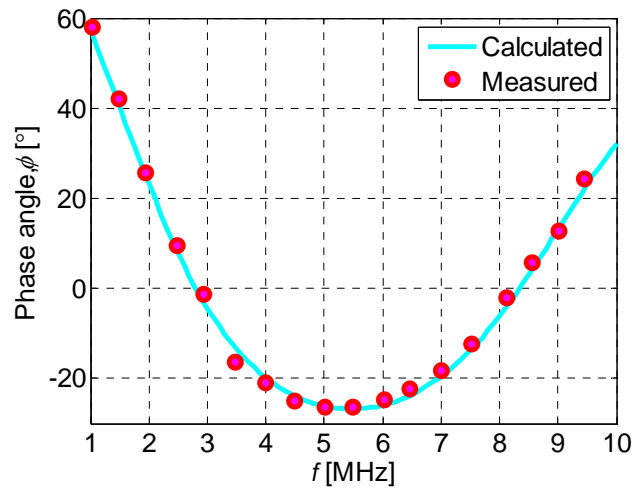

Fig.5. Measured and modelled input impedance phase angle of the coreless PCB step down transformer with $C_r=820\text{pF}$ and $R_L=50\Omega$

The resonant capacitor ' C_r ' across the secondary winding of the transformer as shown in fig. 2 plays an important role in these coreless PCB transformers as it provides the flexible operating frequency region. This transformer has a coupling coefficient of about 0.95.

Energy Efficiency: Since no magnetic core exists, no magnetic core losses are involved in these types of transformers. In addition, the radiation losses in these transformers are negligible compared to the conductor copper losses according to [4]. Therefore, the power loss in the primary and secondary windings of 2:1 step down transformer is given by the following equation.

$$P_{loss} = |i_p|^2 R_{ac}(p) + |i_s|^2 R_{ac}(s) \quad (2)$$

Where, i_p/i_s is the RMS current through the primary/secondary winding and $R_{ac}(p)/R_{ac}(s)$ - Primary/secondary winding ac resistance. The input and output powers of these transformers are obtained from the following equations [3]

$$P_{in} = |V_p|^2 RE \left\{ \frac{1}{Z_{in}} \right\} \quad (3)$$

$$P_{out} = \frac{|V_s|^2}{R_L} \quad (4)$$

And in this case, V_p is the RMS voltage across the primary winding, Z_{in} , the input impedance of the transformer, V_s , the RMS voltage across the secondary winding and R_L is the Load Resistance. The measured energy efficiency of the transformer is given as

$$\eta_{meas} = \frac{P_{out}}{P_{in}} \times 100\% \quad (5)$$

The energy efficiency of the transformer is measured with a resonant capacitor of 820pF and at a load resistance of 50Ω. From fig.6 we can observe that the energy efficiency of the transformer is approximately 95% at a frequency of 2MHz.

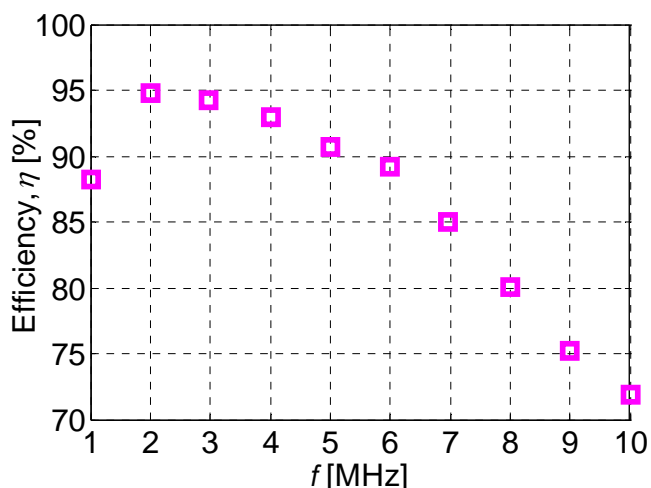

Fig. 6 Measured energy efficiency of the transformer with a resonant capacitor of 820pF and with $R_L=50\Omega$

Since the energy efficiency of the designed coreless PCB step down power transformer is greater than 94%, it is used in the flyback converter circuit in order to evaluate the performance of the transformer in switching circuits.

IV. ZERO VOLTAGE SWITCHING (ZVS) OF THE CONVERTER

In case of hard switching converters, the rate of change of voltage (dv/dt) across the MOSFET and the rate of change of current (di/dt) flowing through the device are high and uncontrollable. The instantaneous power across the device is very high at turn-on and turn-off transition of the MOSFET which increases switching losses of converter. These results in the increased temperature of the converter, stress on the MOSFET and a higher cooling requirement. In addition, because of the high di/dt and dv/dt , there exists lot of EMI emissions from converter and reliability of the converter goes down. And also because of the increased turn-on and turn-off losses of hard switched converter the switching frequency is limited to lower frequencies and thus size of the converter increases. Passive snubbers are used in order to control high di/dt and dv/dt of the device and in this case the device losses are merely transferred to passive snubbers. This reduces the stress on the device at the cost of the energy efficiency of the converter.

There is a requirement to employ some of the soft switching techniques in order to eliminate the aforementioned limitations of hard switched converter. Therefore, in this converter one of the soft switching techniques known as zero voltage switching is employed in order to reduce switching losses of the converter. With the assistance of soft switching techniques, the devices stress can be reduced and it is possible to achieve low EMI emissions from the circuit, reduce the switching losses of the converter and there exists a possibility to improve the diode recovery. In case of ZVS, the switch is turned on when the drain source voltage across the MOSFET is zero which reduces the instantaneous power loss across the device to zero [8]. In general, ZVS can be achieved with the

help of an external inductor and a capacitor which forms the resonant circuit. In case of hard switched converters, the parasitic capacitance and inductance increases the energy loss of the converter and also distracts the circuit performance. Here in soft switching converters, the unwanted parasitic capacitance and inductances prove to be advantageous in order to reach the soft switching conditions.

V. ZVS FLYBACK CONVERTER CIRCUIT WITH ITS ANALYTICAL AND EXPERIMENTAL RESULTS

The coreless PCB step down 2:1 power transformer is used in the flyback converter circuit as shown in fig. 7. The power MOSFET used in this circuit is ZXMN15A27K with V_{dsMax} of 150V and $R_{ds(on)}$ of 0.65Ω. The flyback diode of the converter is a STPS15L45CB schottky diode with a reverse blocking voltage capacity of 45V and the maximum forward average current rating of 15Amps. Here L_r and C_r form the resonant tank circuit in order to achieve ZVS condition. The resonant element L_r includes the transformer leakage inductance, parasitic wire inductances, external resonant inductor, lead inductances and C_r includes the output capacitance of the Mosfet, winding capacitances and the parasitic lead capacitances.

In case of ZVS flyback converter the characteristic impedance (Z_n), resonant frequency (f_r), normalized load resistance (r) and the voltage conversion ratio (M) [9] are given by following equations (9), (10), (11) and (12). These equations are utilized to calculate the theoretical values of the switching frequency of the flyback converter as well as the voltage stress on the mosfet in order to compare with the practical values.

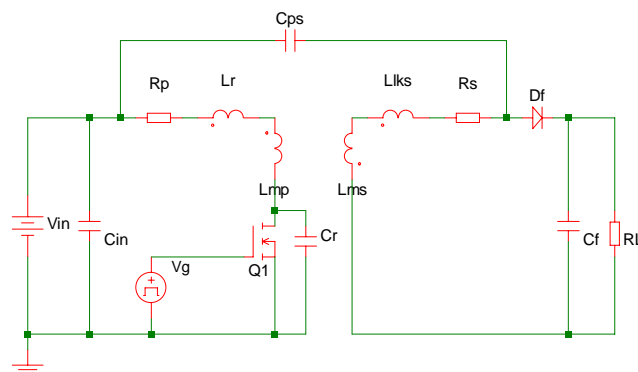

Fig. 7 ZVS flyback converter using coreless PCB step down transformer

$$Z_n = \sqrt{\frac{L_r}{C_r}} \quad (6)$$

$$f_r = \frac{1}{2\pi\sqrt{L_r C_r}} \quad (7)$$

$$r = \frac{R_l}{Z_n} \quad (8)$$

$$M = \frac{V_{out}}{V_{in}} \quad (9)$$

Where,
 R_l is the load resistance of the converter; V_{out}/V_{in} is the output/input voltage of the converter.
 During resonant condition, the drain source voltage V_{ds} of the converter reaches the peak value and it is given as follows:

$$V_{ds_max} = I_m Z_n + V_{in} + N V_{out} \quad (10)$$

Where ' I_m ' is the magnetizing current of the transformer and ' N ' is the turns ratio of the transformer. To achieve the ZVS condition of the converter the following equation must be satisfied.

$$r \leq \frac{M}{N} \quad (11)$$

The expression for the switching frequency f_{sw} of the ZVS flyback converter is given as

$$f_{sw} = fr \left(\frac{2\pi}{(1 + MN) \left[\alpha + \frac{rN}{2M} + \frac{M}{rN} (1 - \cos \alpha) \right]} \right) \quad (12)$$

Where $\alpha = \pi + \arcsin\left(\frac{rN}{M}\right) \quad (13)$

The flyback converter was tested with the following specifications: Input supply voltage of the converter 25-40V DC with a nominal voltage of 32.5V. The output voltage of the converter is regulated at 13Volts for different input voltage conditions. The load resistance is in the range of 15-50 Ω and converter has been tested within the frequency range of 2.7-4.3MHz. Here, the main switch Q1 is driven by the Mosfet driver LM5111-1M which is fed by 1.1ns resolution dsPIC microcontroller. The output capacitance of the mosfet ' C_{oss} ' is 64.5pF at $V_{ds}=25V$. The estimated total resonant capacitor ' C_r ' of the circuit including the parasitic capacitance was 168pF. The leakage inductance of the transformer is 0.46 μH which is a very low value to obtain the ZVS condition within the aforementioned specifications. Therefore, an external resonant inductor of 5.2 μH is chosen so that the switching frequency of the converter falls within the specified range by forming a resonant tank circuit with the total resonant capacitor of 168pF. The theoretical characteristic impedance ' Z_n ' (9) of the circuit is found to be 183.5 Ω and the resonant frequency ' f_r ' (10) of the circuit is 5.16MHz.

By varying the input voltage of the circuit at a given load of 30 Ω the energy efficiency of the unregulated flyback converter under Hard Switched and ZVS condition are plotted as shown in fig.8. The energy efficiency of the converter is drastically improved by the ZVS condition when compared to hard switched condition at the same switching frequency.

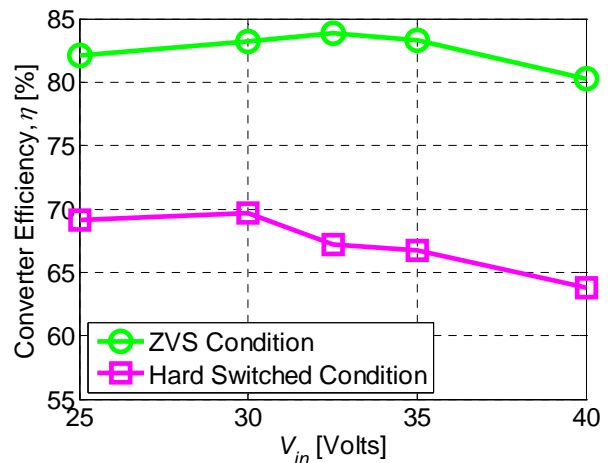

Fig.8 Measured energy efficiency of the unregulated converter under ZVS and Hard switched condition with a resistive load R_l of 30 Ω .

We can observe that the efficiency of the ZVS flyback converter is maximum of 83.8% at the nominal input voltage of 32.5V whereas it is only 67% in case of hard switched converter. In both the cases, the energy efficiency is plotted at 50% duty cycle ratio. Under these conditions the theoretical (13) and practical values of the drain-source voltage of the ZVS flyback converter are determined and are illustrated as shown in fig.9.

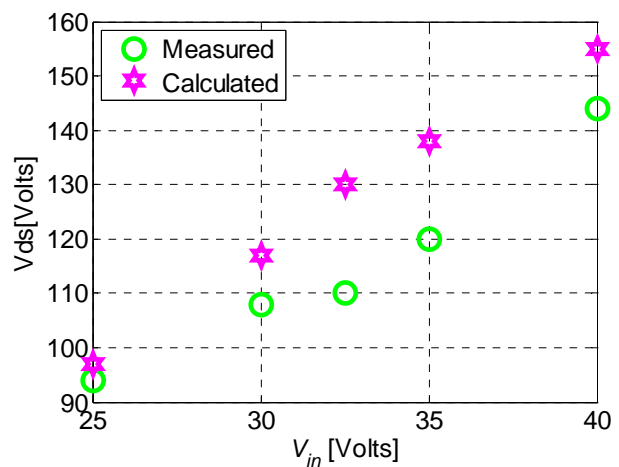

Fig. 9 Measured and Calculated Voltage stress on Mosfet under ZVS condition with a resistive load R_l of 30 Ω .

The output voltage of the converter is also open loop regulated to 13Volts for different input voltage variations i.e., 25-40V with a load resistance of 30 Ω . The constant off time control technique of frequency modulation is employed to regulate the output voltage. Here the output power of the converter is maintained to be 5.7Watts. The energy efficiency of the regulated converter is depicted in Fig.10. It can be observed that the energy efficiency of the converter is maximum at the nominal input voltage of 32.5V and gets reduced at lower and higher input voltages. At lower input

voltage of 25V, for maintaining the same output voltage it is required to increase the duty cycle ratio of the converter.

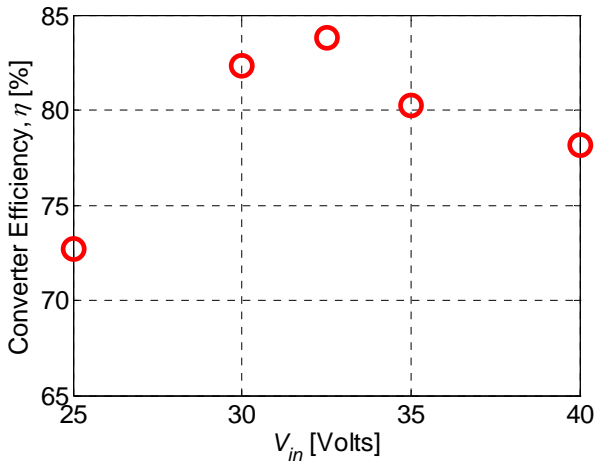

Fig. 10 Measured energy efficiency of the regulated converter with a resistive load R_L of 30Ω under ZVS condition.

This results in the increased input current of the converter which enhances the conduction losses of the Mosfet. Similarly, for maintaining the output voltage of the converter to be constant at higher input voltage of 40V, the switching frequency must be increased which increases the switching losses of the converter. The calculated and the measured switching frequency of the regulated converter are shown in fig.11. Here, as discussed earlier the measured switching frequency of the converter is minimum of about 2.8MHz at lower input voltage and maximum of 4.3MHz at higher input voltage. In all the cases, while determining the energy efficiency of the converter, no consideration is given to the gate drive power consumption.

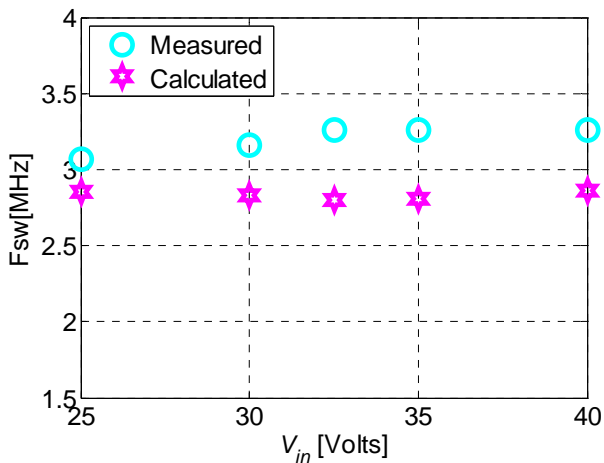

Fig. 11 Measured and calculated switching frequency of the regulated converter circuit with a resistive load R_L of 30Ω under ZVS condition

The converter efficiency was measured with different load resistances ranging from 15-50Ω at a switching frequency of 3.26MHz with an input voltage of 35V shown in fig. 12. The

maximum energy efficiency of the converter is observed to be approximately 84% for the load resistance of 30Ω .

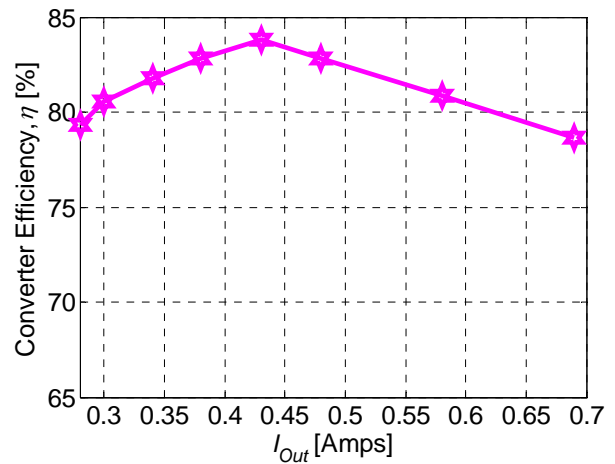

Fig.12 Measured efficiency of the flyback converter circuit with various load resistances

In this case, the output voltage of the converter obtained falls within the range of 10-14Volts at a 50% duty cycle ratio under ZVS condition. With the assistance of frequency modulation, as discussed at an earlier stage, the output voltage of the converter can be regulated.

The waveforms were captured when the converter circuit was operated at $R_{L,max}=50\Omega$ and $R_{L,min}=15\Omega$ and are illustrated in fig. 13 and fig. 14 respectively. The input voltage fed to the converter is of 35V with 50% duty cycle ratio. Fig.13 and fig.14 show the gate to source voltage (V_{gs}) applied to the switch 'Q1', drain to source voltage (V_{ds}) of the switch 'Q1' and the output voltage (V_{out}) of the converter circuit. In fig. 9 and 10 it can be observed from the drain source voltage that the ZVS condition is achieved at a frequency of about 3.26MHz.

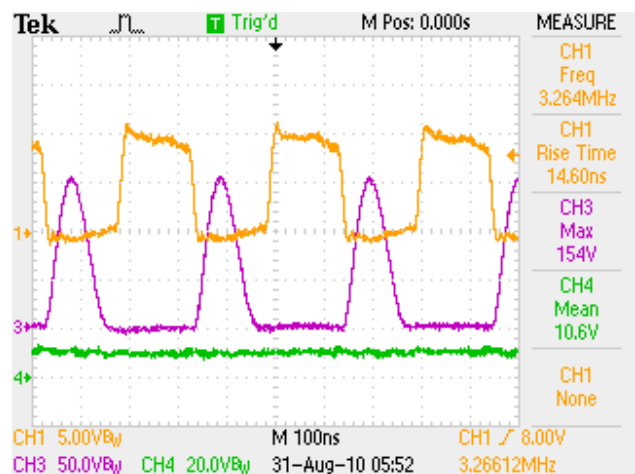

Fig. 13 Measured waveforms with $R_L=15\Omega$. CH1 - V_{gs} (5V/div), CH3 - V_{ds} (50V/div), CH4 - V_{out} (20V/div)

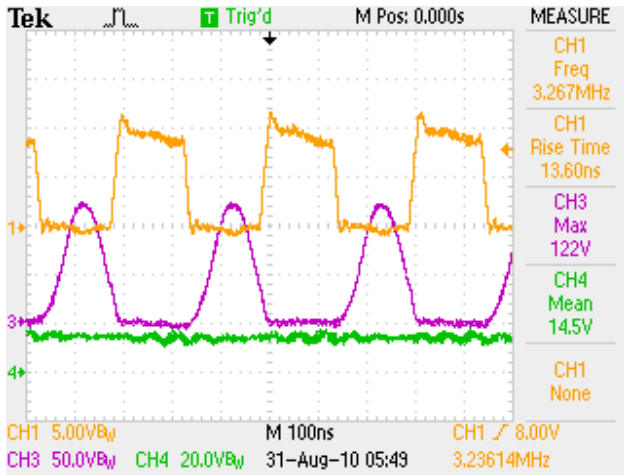

Fig. 14 Measured waveforms with $R_L=50\Omega$. CH1 – V_{gs} (5V/div), CH3 – V_{ds} (50V/div), CH4 – V_{out} (20V/div)

The corresponding magnitude of the maximum drain source voltage is observed to be 154V and 122V respectively for minimum and maximum load s considered. It can be observed that as the load resistance is increased further beyond R_{L_max} , the circuit is losing the property of ZVS condition.

VI. LOSS ESTIMATION OF THE ZVS FLYBACK CONVERTER

The loss estimation of the transformer in the converter has been carried at an input voltage of 40Volts with the resistive load of 30Ω by maintaining the ZVS condition of the circuit. Under these conditions the input power level of the converter is 12.32W and the corresponding output power is 10.05 W with a total power loss of 2.27W. The measured primary and secondary RMS currents of the transformer in the flyback converter are 0.364 and 0.701 amp respectively. The winding resistance of the transformer increases with frequency, starting from the DC resistance value, due to the skin effect. From the dc resistance of the transformer given in table I, the ac resistances are calculated with the following equation [10] by approximating it to circular spiral inductor.

$$R_{ac} = \frac{R_{dc} h}{\delta(1 - \exp(-h / \delta))} \quad (17)$$

Where,

- R_{dc} - DC resistance of the winding
- h - Height of the conductor
- δ - Skin depth

The calculated ac resistances of the primary/secondary windings of the transformer at that particular frequency of 3.45MHz are 2.51/1.25 Ω respectively. Therefore, the corresponding conductor losses of the transformer are obtained from (5) as 0.947W. According to antenna theory, the radiated power from the coreless transformer [3] is calculated by using the following equation.

$$P = 160\pi^6 I_o^2 \left(\frac{af_c}{c} \right)^4 \quad (18)$$

Where,
 'Io' is the RMS current flowing through the winding, 'a' /'fc' is the radius/operating frequency of the transformer and 'c' is velocity of light. As mentioned above, the RMS value of the secondary current through transformer is 0.701amp and radius of the outermost turn is 18mm. The calculated radiated power for the outermost loop of the transformer is 0.138nW and the total averaged radiated power of the transformer including remaining loops is therefore negligible which shows that there are no significant EMI emissions from the transformer. The remaining losses of the converter are shared by the other components such as the ZXMN15A27K (Q1) and the schottky diode STPS15L45CB (Df).For this particular load the temperature across the transformer and the power converter circuit excluding MOSFET driver, are measured with the assistance of an IR thermal camera and the results are depicted in fig. 15 and fig. 16 respectively.

From the temperature profiles and estimated losses of the transformer, we can say that the transformer losses are less when compared to the circuit losses of the converter.

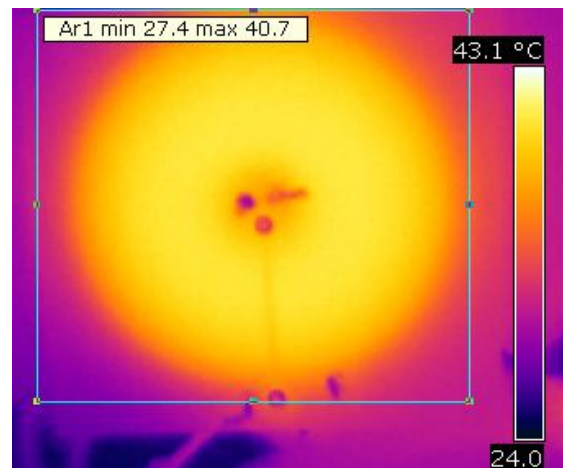

Fig.15 Measured temperature of the transformer in the flyback converter circuit

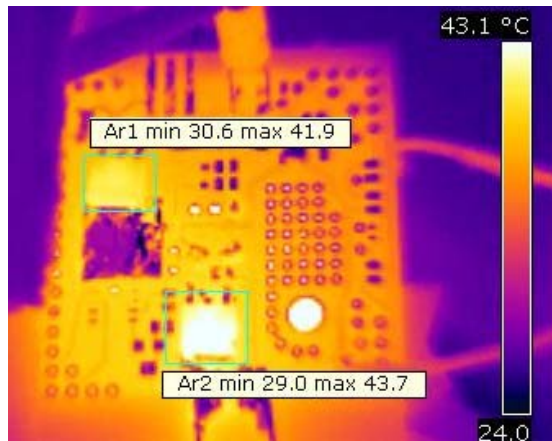

Fig.16 Measured temperature of the flyback converter circuit excluding the transformer with Ar1 - Area of the Switch ZXMN15A27K (Q1), Ar2 - Area of the schottky diode STPS15L45CB.

VII. CONCLUSIONS

A low profile, low cost ZVS flyback converter using a multilayered coreless PCB step down transformer operating in the MHz frequency range has been successfully demonstrated. This converter has been tested up to the output power level of 10W. The optimal switching frequencies of the converter in order to achieve higher efficiencies are determined analytically. The ZVS technique is incorporated into the flyback circuit in order to minimize the converter losses, EMI emissions from the circuit by reducing the di/dt and dv/dt. Under this ZVS condition for the converter circuit, the maximum energy efficiency of the converter obtained is approximately 84%. It can be concluded that there is a lot of improvement in terms of energy efficiency in ZVS converter when compared to hard switched flyback converter. The highest efficiency reported in the isolated topology operating in MHz frequency region is within the range of 70-80% in the forward converter [11] by using the two layered 14:10 transformer. In our case, by using the multilayered coreless transformer the maximum energy efficiency of the regulated converter is about 84%. This work provides a significant step in increasing the switching frequency to the MHz region with the help of multilayered step-down coreless pcb transformer for isolated DC/DC converters, enabling smaller and more compact designs to be considered in the future. The transformer technology works efficiently up to at least the tested input power level of 12.32W and here in this case the switching devices are the main limitations for further development. The power level of the design can be increased with improved thermal management. The output voltage of the converter for varied input voltage is regulated by using the constant off time frequency modulation technique. From the experimental analysis it can be concluded that a high frequency isolated switch mode power supply operating in the MHz region can be designed by using these multilayered

coreless PCB step down transformers. These coreless PCB step down power transformers plays an important role where there is a tight restrictions on the height of the converter.

ACKNOWLEDGMENT

The authors would like to thank VINNOVA, The Swedish Energy Agency and European Union for their financial support.

REFERENCES

- [1] Wong Fu Keung, "High Frequency transformers for switch mode power supplies" Griffith University, 2004
- [2] Li Rulai and Zhu Yisheng "The structure and Analysis of Coreless printed Circuit Board Transformers", 2003, IEEE, ISBN: 0-7803-7831-8
- [3] S.C.Tang, S.Y.R. Hui and H. Chung, "Coreless Printed Circuit Board (PCB) Transformers -Fundamental characteristics and application potential", ISSN 1049-3654, vol 11, No.3, December 2000
- [4] Hui,S.Y.R, Tang,S.C., and Chung,H., "Coreless printed-circuit-board(PCB) transformers for signal and energy transfer", Electron.Lett.,1998,34,(11),pp.1052-1054
- [5] Abraham I. Pressman, 'Switching Power Supply Design' 2nd Edition, McGraw-Hill, pp.105
- [6] C.F.Coombs, 'Printed Circuits handbooks' 5th Edition, McGraw-Hill, August 27, 2001
- [7] Alex Van den Bossche and Vencislav Cekov Valchev, 'Inductors and Transformers for Power Electronics' 1st Edition, CRC Press, March 24, 2005
- [8] Robert W. Erickson, 'Fundamentals of Power Electronics' 2nd Edition, Springer International Edition, pp.505.
- [9] Wojciech A. Tabisz, Pawel M. Gradzki and Fred C.Y.Lee, "Zero-Voltage-Switched Quasi-Resonant Buck and Flyback Converters- Experimental Results at 10MHz" IEEE transactions on power Electronics, vol.4, No.2, April 1989.
- [10] Heng-Ming Hsu, "Effective series-resistance model of spiral inductors", Microwave and Optical technology letters, vol.46, No.2, July 20 2005.
- [11] Sun-Min Hwang and Tae-Young Ahn, 'A ZVS forward DC-DC Converter using Coreless PCB transformer and Inductor' 2001.