

# Automatic Generation Control of Multi-Area Electric Energy Systems Using Modified GA

Gayadhar Panda, Sidhartha Panda and C. Ardil

**Abstract**—A modified Genetic Algorithm (GA) based optimal selection of parameters for Automatic Generation Control (AGC) of multi-area electric energy systems is proposed in this paper. Simulations on multi-area reheat thermal system with and without consideration of nonlinearity like governor dead band followed by 1% step load perturbation is performed to exemplify the optimum parameter search. In this proposed method, a modified Genetic Algorithm is proposed where one point crossover with modification is employed. Positional dependency in respect of crossing site helps to maintain diversity of search point as well as exploitation of already known optimum value. This makes a trade-off between exploration and exploitation of search space to find global optimum in less number of generations. The proposed GA along with decomposition technique as developed has been used to obtain the optimum megawatt frequency control of multi-area electric energy systems. Time-domain simulations are conducted with trapezoidal integration along with decomposition technique. The superiority of the proposed method over existing one is verified from simulations and comparisons.

**Keywords**—Automatic Generation Control (AGC), Reheat, Proportional Integral (PI) controller, Dead Band, Genetic Algorithm (GA).

## I. INTRODUCTION

MEGAWATT frequency control or Automatic Generation Control (AGC) problems are that of sudden small load perturbations which continuously disturb the normal operation of an electric energy system. In the literature, there has been considerable effort devoted to automatic generation control of interconnected electric energy system [1-5]. These approaches may be classified into two categories as follows:

1. Energy storage system: Examples are pumped storage system, superconducting magnetic energy storage system, battery energy storage system etc. [6, 7].
2. Control strategy: This category focuses on the design of an automatic generation controller to achieve better dynamic performance [8-10].

In this paper, design of AGC controller is investigated. Many controllers have been proposed for AGC problem in order to achieve a better dynamic performance. Examples are the proportional integral (PI) control [3], state feedback control based on linear optimal control theory [4], and output

feedback [5]. Recently, AGC based on fuzzy controller has also been proposed [11]. Among the aforementioned controllers, the most widely employed one is the fixed gain controller, like integral controller or PI controller due to its low cost and high reliability in operation. Fixed gain controllers are designed at nominal operating points and may no longer be suitable in all operating conditions. For this reason, some authors have applied the variable structure control [14] to make the controller insensitive to the system parameter changes. However, this method requires the information of the system states, which are very difficult to predict and collect completely.

For optimization of any AGC strategy, the designer has to resort to studying the dynamic response of the system. Study of dynamic response of modern large multi area power system costs in terms of computer memory and time. Moreover, inclusion of governor dead band nonlinearities in the system model makes the solution process more complex. Therefore, there is always an impelling motive to search for a suitable mathematical model and an easier method of solution.

All these motivate a more practical approach for parameter optimization in AGC of multi-area electric energy systems using modified Genetic Algorithm. A digital simulation is used in conjunction with the proposed Genetic Algorithm (GA) to determine the optimum parameters of the AGC for each of the performance indices considered. Genetic Algorithms are used as parameter search techniques, which utilize the genetic operators to find global optimal solutions [9-12]. For solution of system state equations, decomposition technique [13] along with trapezoidal integration method is used to overcome the difficulty of large multi-area power system.

A number of different methods for optimizing well-behaved continuous functions have been developed which rely on using information about the gradient of the function to guide the direction of search [13]. If the derivative of the function cannot be computed, because it is discontinuous, for example, these methods often fail. Such methods are generally referred to as *hill climbing*. They can perform well on functions with only one peak (*unimodal* functions). But on functions with many peaks, (*multimodal* functions), they suffer from the problem that the first peak found will be climbed, and this may not be the highest peak. Having reached the top of a local maximum, no further progress can be made.

The significant contributions of this work are as follows:

- In this work, a modified Genetic Algorithm is proposed. One point crossover with modification is employed. Positional dependency in respect of crossing site helps to maintain diversity of search point as well as exploitation of already known optimum value. This makes a trade-off

Gayadhar Panda is with the Electrical Engineering, IGIT, Sarang, Orissa, India, Pin: 759146. (e-mail: p\_gayadhar@yahoo.com)

S. Panda is with the National Institute of Science and Technology (NIST) Berhampur, OR 760007 India (e-mail: panda\_siddhartha@rediffmail.com).

C. Ardil is with National Academy of Aviation, AZ1045, Baku, Azerbaijan, Bina, 25th km, NAA (e-mail: cemalardil@gmail.com)

between exploration and exploitation of search space to find global optimum in less number of generations.

- The proposed GA along with decomposition technique as developed has been used to obtain the optimum megawatt frequency control of multi-area electric energy systems. Time-domain simulations are conducted with trapezoidal integration along with decomposition technique.
- Since decomposition technique is used, there are no limitations in number of areas interconnected. The solutions of state equations are found by trapezoidal integration method, which is more tolerant towards a large integration time interval. Therefore, there is a considerable saving in computational time and core memory.
- In this technique, care has been taken in the model to include nonlinearity due to governor deadband.

This paper is organized as follows. The system model is discussed in section two. In section three, trapezoidal integration with decomposition technique is described. In section four, an overview of proposed Genetic Algorithm for function optimization is given. Then the results of simulation study for four-area reheat thermal power station with and without consideration nonlinearity due to governor deadband are in section five. Finally some conclusions are drawn and future works are suggested in section six.

## II. SYSTEM MODEL

The system under consideration is exposed to small change in load during its normal operation; so a linear model is sufficient for its dynamic representation. Fig. 1 shows the transfer function model for single area representation of reheat thermal system.

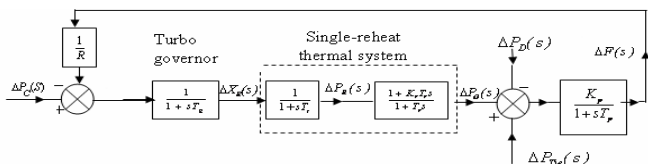

Fig. 1 Transfer Function Model of Single-Reheat Thermal System

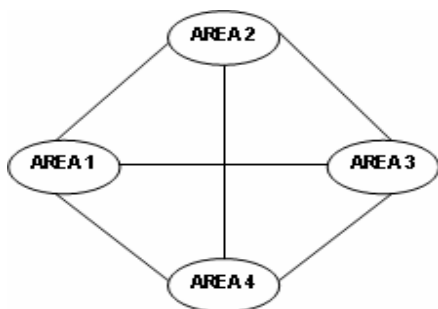

Fig. 2 Physical Connection of Four-Area System

In this case, the proposed algorithm is applied to the following two cases:

- Case-A Four-area interconnected reheat thermal system.

- Case-B Four-area interconnected reheat thermal system with governor dead band nonlinearity.

The physical connection of four-area interconnected power system has been depicted in Fig. 2. A typical block diagram of a single area ( $k_{th}$  area) perturbation model is shown in Fig. 3.

### A. Sub System Model of Multi-Area Reheat Thermal System

A mathematical model is to be developed to study the load frequency dynamics of multi area interconnected reheat thermal electric energy system using decomposition technique [12].

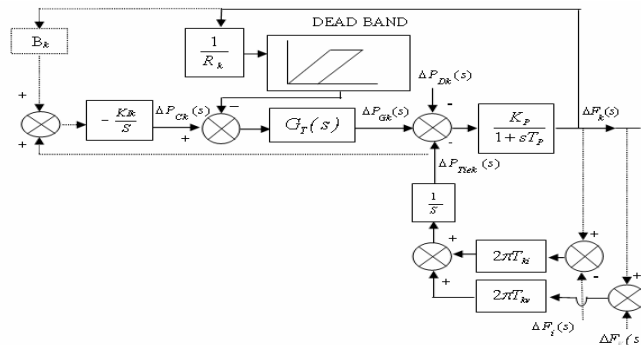

Fig. 3 Block Diagram of Single Area ( $k_{th}$  Area) Perturbation Model with Nonlinearity (Considering Deadband)

Here the tie-line power deviations  $\Delta P_{Tiek}$  can be assumed as an additional power disturbance to any area  $k$ . Accordingly, using decomposition technique the area wise sub system equations are derived considering small load change as follows:

$X_1 = \Delta F$ ,  $X_2 = \Delta X_E$ ,  $X_3 = \Delta P_G$ ,  $X_4 = \dot{X}_3$ ,  $X_5 = \Delta P_{Tie}$ ,  $X_6 = \Delta P_C$ .  
 Referring to Figure 3 of  $k_{th}$  area, we can write

$$\dot{X}_1 = -\frac{1}{T_p} X_1 + \frac{K_p}{T_p} X_3 - \frac{K_p}{T_p} X_5 - \frac{K_p}{T_p} \Delta P_D(t)$$

$$\dot{X}_2 = A_{21} X_1 + \frac{1}{T_g} X_2 + \frac{1}{T_g} X_6$$

$$\dot{X}_3 = X_4$$

$$\dot{X}_4 = A_{41} X_1 + A_{42} X_2 + A_{43} X_3 + A_{44} X_4 + A_{46} X_6$$

$$\dot{X}_5 = 2\pi \sum_{\substack{i=1 \\ i \neq K}}^M T_{ki} X_i - 2\pi \sum_{\substack{i=1 \\ i \neq K}}^M T_{ki} \Delta F_i$$

$$\dot{X}_6 = -K_{lk} B X_1 - K_{lk} X_5$$

Referring to Figure 3 (a) for any area  $k$ , the above equations can be written as:

$$\begin{bmatrix} \dot{X} \end{bmatrix}_k = [A]_k [X]_k + [U]_k \quad (1)$$

where

$$\begin{bmatrix} \dot{X} \end{bmatrix}_k^T = \begin{bmatrix} \dot{X}_1 & \dot{X}_2 & \dot{X}_3 & \dot{X}_4 & \dot{X}_5 & \dot{X}_6 \end{bmatrix}_k$$

$$[A]_k = \begin{bmatrix} -\frac{1}{T_p} & 0 & \frac{K_p}{T_p} & 0 & -\frac{K_p}{T_p} & 0 \\ A_{21} & -\frac{1}{T_g} & 0 & 0 & 0 & \frac{1}{T_g} \\ 0 & 0 & 0 & 1 & 0 & 0 \\ A_{41} & A_{42} & A_{43} & A_{44} & 0 & A_{46} \\ 2\pi \sum_{\substack{i=1 \\ i \neq k}}^M T_{ki} & 0 & 0 & 0 & 0 & 0 \\ -K_I B & 0 & 0 & 0 & -K_I & 0 \end{bmatrix}_k$$

$$[U]_k^T = \begin{bmatrix} -\frac{K_p}{T_p} \Delta P_D(t) & U_2(t) & 0 & U_4(t) & -2\pi \sum_{\substack{i=1 \\ i \neq k}}^M T_{ki} \Delta F_i & 0 \end{bmatrix}_k$$

For linear model the value for A's and U's are as follows:

$$A_{21} = -\frac{1}{RT_g}, \quad A_{41} = -\frac{K_r}{RT_g T_t}$$

$$A_{42} = \left( \frac{1}{T_t T_r} - \frac{K_r}{T_g T_t} \right)$$

$$A_{43} = -\frac{1}{T_r T_t}, \quad A_{44} = -\frac{(T_r + T_t)}{T_r T_t}, \quad A_{46} = \frac{K_r}{T_g T_t}$$

$$U_2(t) = 0, U_4(t) = 0$$

System equation for last area can be obtained as follows:

$$\text{Since } \sum_{i=1}^M \Delta P_{Tie i} = 0 \quad (2)$$

$$\Delta P_{Tie M} = -\sum_{i=1}^{M-1} \Delta P_{Tie i} \quad (3)$$

Making this substitution, one gets the A matrix for last area (i.e.  $M_{th}$  area) to be of the order  $(N-1) \times (N-1)$ . The state equation for last area is given below:

$$\begin{bmatrix} \dot{X} \end{bmatrix}_M = \begin{bmatrix} -\frac{1}{T_p} & 0 & \frac{K_p}{T_p} & 0 & 0 \\ A_{21} & -\frac{1}{T_g} & 0 & 0 & \frac{1}{T_g} \\ 0 & 0 & 0 & 1 & 0 \\ A_{41} & A_{42} & A_{43} & A_{44} & A_{46} \\ -K_I B & 0 & 0 & 0 & 0 \end{bmatrix}_M \begin{bmatrix} X \end{bmatrix}_M + \begin{bmatrix} -\frac{K_p}{T_p} \Delta P_D(t) + \frac{K_p}{T_p} \sum_{j=1}^{M-1} \Delta P_{Tie j} \\ U_2(t) \\ 0 \\ U_4(t) \\ K_I \sum_{j=1}^{M-1} \Delta P_{Tie j} \end{bmatrix}_M$$

### B. Subsystem Model of Mutli-Area Reheat Thermal System with Deadband Nonlinearity

The speed governor dead band has a great effect on the dynamic performance of electric energy system. For more realistic analysis the governor dead band has to be included

which makes the system non-linear. The proposed method is applied to investigate the effect of dead band on the dynamic performance. The magnitude of dead band is taken as 0.06 %. For cases presented here the initial position of dead band is selected so that the entire dead band of each area has to be traversed before a response is secured. The system can be anywhere within the dead band. The block diagram of single-area ( $k_{th}$  area) perturbation model with governor deadband is depicted in Figure 3.

The factor  $\Delta F$  varies rather slowly with time and so if the integration time interval is chosen sufficiently small, one can reasonably assume that during any particular time interval each area operates entirely in side the dead band or outside it. Therefore the system to be considered becomes essentially a piecewise linear system when governor dead band is included. For each area there will be two [A] Matrices, one for operation inside the dead band region and the other for operation outside it. They are derived as follows.

### Nonlinear model (Considering dead band DB)

#### (i) Operation inside Dead Band:

There will be no signal proportional to frequency deviation. Therefore values of A's and U's are as below:

$$A_{21} = 0, \quad A_{41} = 0, \quad U_2(t) = 0,$$

$$U_4(t) = 0$$

other A's remain same as the values in linear case.

#### (ii) Operation outside Dead Band:

When frequency deviation greater than the DB the signal will be proportional to  $(|\Delta F| - DB)\text{sign}(\Delta F)$ . Therefore the value of A's and U's are as follows:

$$A_{21} = -\frac{1}{RT_g}, \quad A_{41} = -\frac{K_r}{RT_g T_t}$$

$$U_2(t) = \frac{DB}{RT_g} \text{sign}(\Delta F),$$

$$U_4(t) = \frac{K_r}{RT_g T_t} DB \text{sign}(\Delta F)$$

The other A's for both of the above cases are as below:

$$A_{42} = \left( \frac{1}{T_t T_r} - \frac{K_r}{T_g T_t} \right), \quad A_{43} = -\frac{1}{T_r T_t}$$

$$A_{44} = -\frac{(T_r + T_t)}{T_r T_t}, \quad A_{46} = \frac{K_r}{T_g T_t}$$

The other values remain same as in linear model.

### III. TRAPEZOIDAL INTEGRATION WITH DECOMPOSITION TECHNIQUE

Applying trapezoidal integration technique to the equation:

$$\begin{bmatrix} \dot{X} \end{bmatrix} = [A][X] + [U]$$

one gets

$$\frac{[X(t+\Delta t)] - [X(t)]}{\Delta t} = \left[ A \frac{[X(t+\Delta t)] + [X(t)]}{2} + \frac{[U(t+\Delta t)] + [U(t)]}{2} \right] \quad (4)$$

where

$\Delta t$  integration time interval

$X(t)$  values of state variables at the end of time  $t$

$X(t + \Delta t)$  values of state variables at the end of time  $(t + \Delta t)$

On simplification, from equation (4), we obtain

$$\left[ I - A \frac{\Delta t}{2} \right] [X(t+\Delta t)] = \left[ I + A \frac{\Delta t}{2} \right] [X(t)] + \frac{[U(t+\Delta t)] + [U(t)]}{2} \Delta t \quad (5)$$

$$[X(t + \Delta t)] = [SM][Y] \quad (6)$$

where

$$[SM] = \left[ I - A \frac{\Delta t}{2} \right]^{-1}$$

$$\text{and } [Y] = \left[ I + A \frac{\Delta t}{2} \right] [X(t)] + \frac{[U(t + \Delta t)] + [U(t)]}{2} \Delta t$$

When equation (6) is used with the decomposition technique, the procedure becomes iterative. The equation (6) can be written as:

$$[X^{(i+1)}(t + \Delta t)] = [SM] \left[ [X1(t)] + [U^{(i+1)}(t + \Delta t) + U(t)] \frac{\Delta t}{2} \right] \quad (7)$$

where

$$X1(t) = \left[ I + A \frac{\Delta t}{2} \right] [X(t)]$$

and  $i$  denotes the iteration count.

From equation (7) it can be seen that  $X^{(i+1)}(t + \Delta t)$  consists of two parts, one is a fixed part and another is a variable part, which varies in every iteration. Equation (7) can be written as:

$$X^{(i+1)}(t + \Delta t) = X2(t + \Delta t) + X3^{(i+1)}(t + \Delta t) \quad (8)$$

where  $X2$  is the fixed part and given by

$$[X2(t + \Delta t)] = [SM] \left[ [X1(t)] + [U(t)] \frac{\Delta t}{2} \right]$$

and  $X3$  is the variable part and given by

$$[X3^{(i+1)}(t + \Delta t)] = [SM] \left[ [U^{(i+1)}(t + \Delta t)] \frac{\Delta t}{2} \right]$$

It is observed that it will be enough to iterate on  $X3$  only. Once convergence is obtained,  $X(t + \Delta t)$  can be determined as  $X2 + X3$ .

#### IV. PROPOSED MODIFIED GA ALGORITHM

The following two modifications have been proposed

- Modification in parent selection
- Modification in crossover mechanism

##### A. Proposed Parent Selection

Depending upon the values of fitness function, pairs of strings are selected from the population pool at random for forming a mating pool. In a simple GA approach this is termed as reproduction. And the strings are selected into the mating pool by simple Roulette wheel selection. In this proposed algorithm, the following modifications are applied for the selection of parents so that the strings with large values of fitness are copied more into the mating pool.

- The first parent in each reproduction is the string having the best fitness value. The second parent is selected from the ordered population using normal selection technique.
- At the  $i^{\text{th}}$  reproduction, first parent is the best string of the population arranged in the order of fitness values. Second parent is selected from the ordered population using normal selection technique.

##### B. Proposed Crossover

Crossover is an algorithm for artificial mating of two individual chromosomes with an expectation that a combination of genes of individuals of high fitness value may produce an offspring with even higher fitness. It represents a way of moving in the solution space based on the information derived from the existing solutions. This makes exploitation and exploration of information encoded in genes.

In this proposed algorithm, the following modifications have been proposed with an intuition to have better trade-off between exploration of unknown solution space and exploitation of already known knowledge of solution to find the global optimum in less number of generations. In this work, one point crossover also called Holland crossover is adopted with a probability  $Pc \in [0.6, 0.95]$  with modifications in exchange of chromosomal materials.

In a binary coded chromosome if the value of right most bits is changed  $[1 \rightarrow 0, 0 \rightarrow 1]$ , the search point in the search space shifts to a nearby point. This helps in refining the optimum point in the already known search space. As one proceeds towards the left from the right most bit of the chromosome, the shifting of search point in the search space increases and it depends on the position of the bit in the chromosome whose value is changed. The shifting is highest with the change in the left most bit. This facilitates to explore new region in the search space by shifting the search point wide apart from the current optimum position in the search space.

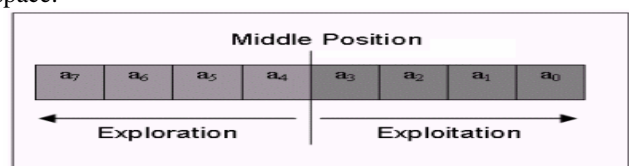

Fig. 4 (a) Example of Exploration and Exploitation in the Search Space

Therefore, it is evident that the exploitation of already known region or exploration of unknown region in the search space is relatively depending upon the position of the bit in the chromosome whose value changes. In a chromosome change in the bits towards the right from the middle position contribute more towards the exploitation of already known region. Similarly, change in the bits towards the left from the middle position contributes more towards exploration of new region in the search space. This is shown in the Fig. 4(a).

Thus the positional dependency of crossing site in respect of middle point of the chromosome helps to maintain diversity of the search point as well as improve the value of already known optimum value.

Here the mechanism of crossover is not same as that of one point crossover. In this proposed scheme, the exchange of chromosomal material between two parents is made considering the position of crossover site with respect to the mid point of the chromosome. If the crossover site falls towards the right of the mid point of the chromosome, the right side chromosomal material from the crossover site of the fitter parent is replaced with that of other parent to form one offspring. If the crossover site falls towards the left of the middle position of the chromosome, the left side chromosomal material from the crossover site of the fitter parent is replaced with the other parent to form one offspring.

Fig. 4(b) shows an example of crossover procedure. Thus by generating one random number, only one offspring is produced by crossover. For each pair of parent, two random numbers are generated to produce two offspring. The pseudo code for the proposed crossover is shown in Fig. 4(c).

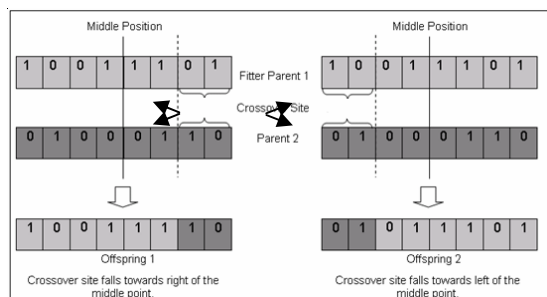

Fig. 4 (b) Example of Crossover Procedure

### C. Algorithm Steps for Optimization of AGC Parameters

With the above descriptions, the procedure of a proposed genetic algorithm for power system AGC is given as follows:

- I. Generate randomly a population of parameter strings to form parameter vector.
- II. Using digital simulation of system model, to calculate the fitness (ISE and ITAE) for each string in the population.
- III. Create offspring strings by proposed GA operators: reproduction, crossover and mutation.
- IV. Evaluate the new strings and calculate the fitness for each string.

- V. If the search goal is achieved, or an allowable generation is attained, stop and return, else go to third step (III).

```

// Procedure Proposed Crossover
// n    → population size
// cs   → crossover site
// l    → length of chromosome
// midl → midpoint of chromosome length

begin
  //Selection of two chromosomes
  Chromo (cn) = best chromo of pop(n)
  Chromo (cn-1) = Roulette wheel pop(n-1)
  for i=1 to 2 do
    begin
      //Selection of crossover site
      cs → rand (1,l)
      if (cs towards right midl)
        offspring = chromo (cn) upto cs + chromo (cn-1)
      after cs
      else
        offspring = chromo (cn-1) upto cs +chromo (cn)
      after cs
    end
  end

```

Fig. 4 (c) The Pseudo Code for the Proposed Crossover

## V. SIMULATION RESULTS

To demonstrate the effectiveness of the proposed algorithm, some simulations have been carried out for a four-area interconnected AGC power system structured as in Fig. 2. Simulations for the proposed method are carried out on a computer with following specifications: Pentium-4 processor, 1.89 GHz.. The system parameters are tabulated in the Appendix-A. In this part of the study, a conventional AGC, which is only integral is considered. The parameters involved in the feedback are the integral controller ( $K_{Ik}$ ) and the frequency bias constant ( $B_k$ ). The optimal values of these parameters depend upon the cost function used for optimization. Each individual in the initial population has an associated performance index ( $PI$ ) value. The performance indices [14] used here are of the form:

- I. The integral of the square of the error criterion (ISE). It is given by

$$ISE = \int_0^{\infty} \left( \sum_{k=1}^{M-1} \Delta P_{Tiek}^2 + \sum_{k=1}^M \Delta f_k^2 \right) dt \quad (9)$$

- II. The integral of time-multiplied absolute value of the error criterion (ITAE). The criterion penalizes long-duration transients and is much more selective than the ISE. A system designed by use of this criterion exhibits small overshoot and well damped oscillations. It is given by

$$ITAE = \int_0^{\infty} t \left( \sum_{k=1}^{M-1} |\Delta P_{Tiek}| + \sum_{k=1}^M |\Delta f_k| \right) dt \quad (10)$$

To simplify the analysis, the four interconnected areas were considered identical. The optimal parameter value is such that

$$K_{I1}=K_{I2}=K_{I3}=K_{I4}=K_I \text{ and } B_1 = B_2 = B_3 = B_4 = B$$

The optimum values of the parameters  $K_I$  and  $B$  for two different test cases corresponding to the performance indices considered, as obtained using proposed Genetic Algorithm (GA), are summarized in Table-1(a) and Table-1(b) respectively.

TABLE I (A) OPTIMUM VALUES OF  $K_I$  &  $B$  (CASE-A)

Parameter	ISE	ITAE
$B$	0.401	0.392
$K_I$	0.706	0.807
$PI$	0.546	2.346

TABLE II (B) OPTIMUM VALUES OF  $K_I$  &  $B$  (CASE-B)

Parameter	ISE	ITAE
$B$	0.340	0.321
$K_I$	0.861	0.640
$PI$	0.554	2.236

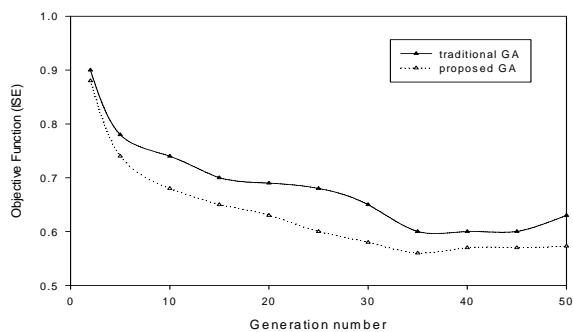

Fig. 5(a) Objective Function (ISE) vs. Generation Number

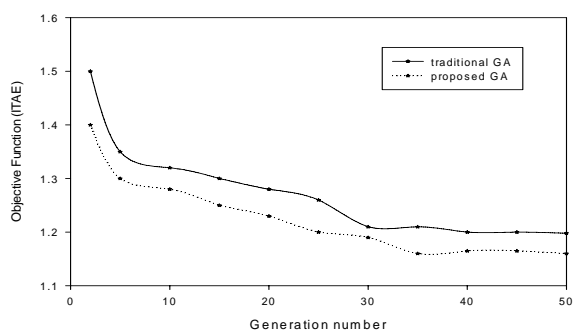

Fig. 5(b) Objective Function (ITAE) vs. Generation Number

Fig. 5(a) shows the profile of objective function (ISE) versus generation number. It is revealed from the figure that the ISE value is smaller for the same generation number with the proposed GA as compared to traditional GA. Similarly; it is also observed from the Fig. 5(b) that the value of ITAE is smaller at the same generation number with the proposed GA compared to the traditional GA. As it is evident that the proposed GA works better in comparison to traditional GA for

obtaining optimal AGC parameters of interconnected power system.

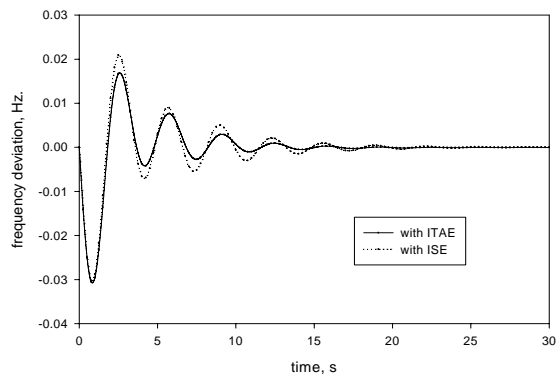

Fig. 6 (a) Frequency deviation in Area-1

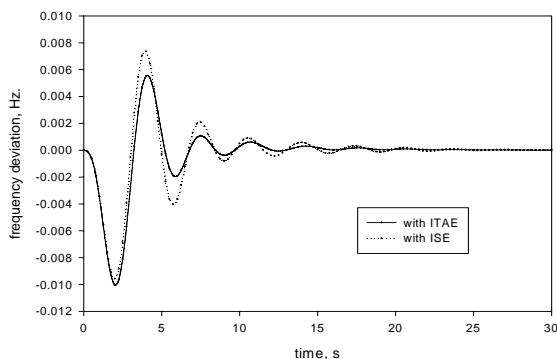

Fig. 6 (b) Frequency deviation in Area-3

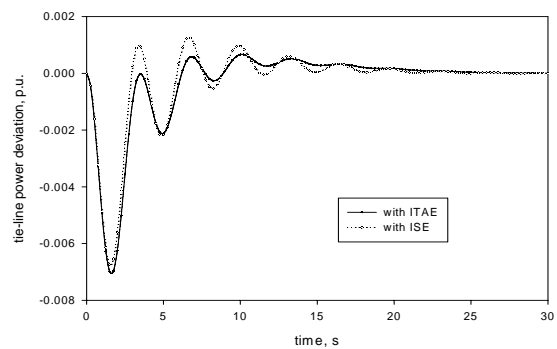

Fig. 6 (c) Tie-line power deviation in Area-1

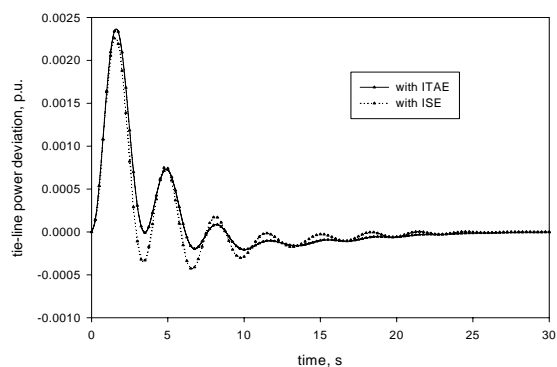

Fig. 6 (d) Tie-line power deviation in Area-3

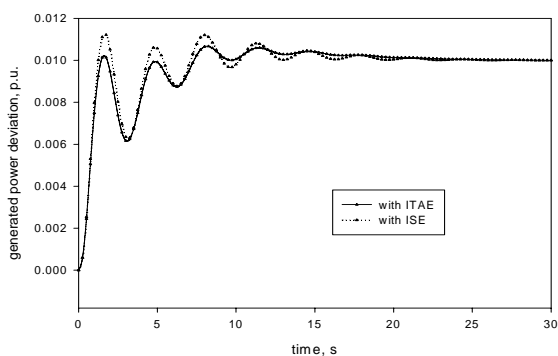

Fig. 6 (e) Generated power deviation in Area-1

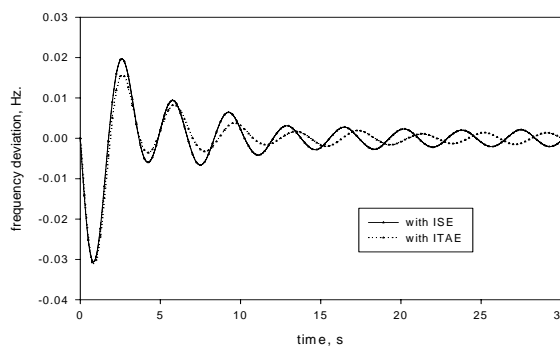

Fig. 7 (a) Frequency deviation in area-1

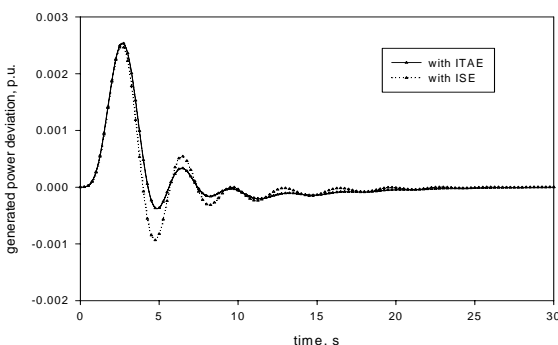

Fig. 6 (f) Generated power deviation in Area-3

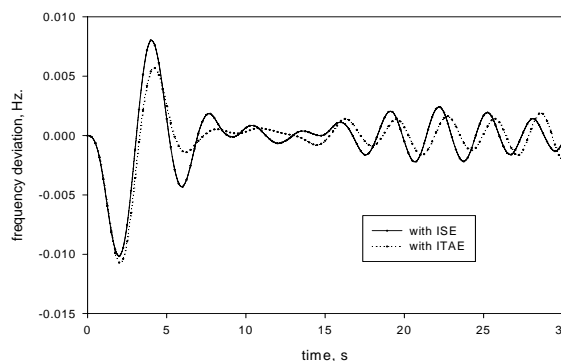

Fig. 7 (b) Frequency deviation in area-3

Fig. 6 Response of Four-area Reheat Thermal System with Optimal AGC Parameters (Case-A). Dotted curve corresponding to ISE and solid curve corresponding to ITAE.

Fig. 6 shows the dynamic response of four-area interconnected power system corresponding to Table-1(a). Each figure contains two curves corresponding to two different performance indices. In Fig. 6, the dotted curves show the responses with the performance index ISE, whereas the solid curves show the responses with the performance index ITAE. The response obtained when the parameters are set according to the ITAE indicate that the damping of oscillation is much improved and the transient error in frequency, tie-line power and generated power is also much reduced. Table-2(a) shows transient overshoot with different performance indices for Test Case A.

TABLE II(A) OVERSHOOT WITH DIFFERENT PERFORMANCE INDICES FOR TEST CASE A

Area no.	Nature of response	Maximum Overshoot/Undershoot corresponding to performance index (PI)	
		ISE	ITAE
Area-1	$\Delta f_1$	0.0225 Hz.	0.0185 Hz.
	$\Delta P_{Tie1}$	0.0073 p.u.	0.0073 p.u.
	$\Delta P_{G1}$	0.0118 p.u.	0.010 p.u.
Area-3	$\Delta f_3$	0.011 Hz	0.010 Hz.
	$\Delta P_{Tie3}$	0.0021 p.u.	0.0021 p.u.
	$\Delta P_{G3}$	0.0036 p.u.	0.0025 p.u.

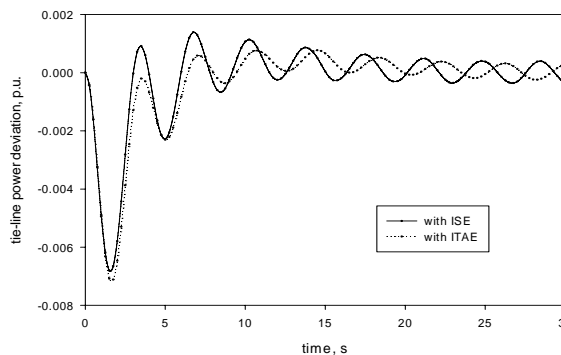

Fig. 7 (c) Tie-line power deviation in area-1

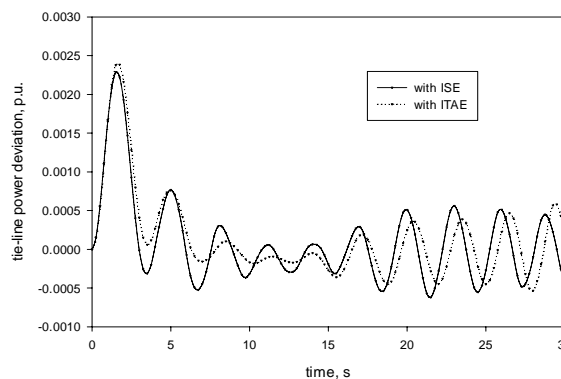

Fig. 7 (d) Tie-line power deviation in area-3

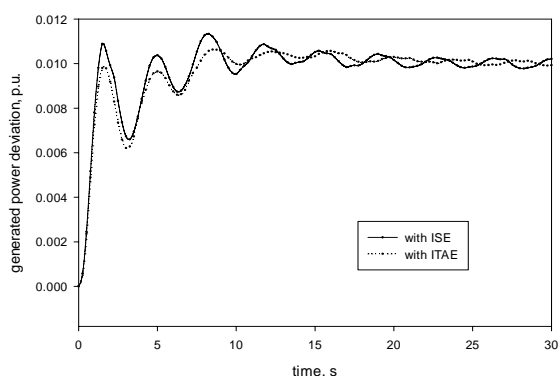

Fig. 7 (e) Generated power deviation in area-1

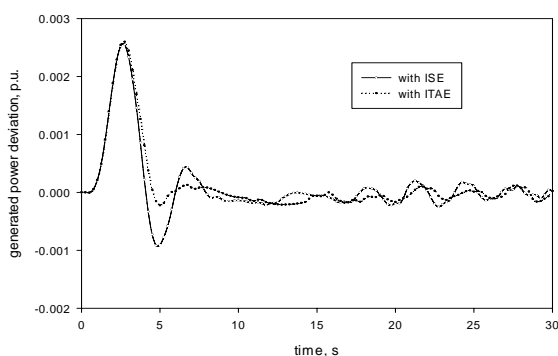

Fig. 7 (f) Generated power deviation in Area-3

Fig. 7 Dynamic response of Four-area Reheat Thermal System with Optimal AGC Parameters (Case-B). Dotted curve corresponding to ISE and solid curve corresponding to ITAE.

TABLE II(B) OVERSHOOT WITH DIFFERENT PERFORMANCE INDICES FOR TEST CASE B

Area no.	Nature of response	Maximum Overshoot/Undershoot corresponding to performance index (PI)	
		ISE	ITAE
Area-1	$\Delta f_1$	0.0315 Hz.	0.03 Hz.
	$\Delta P_{Tie1}$	0.0016 p.u.	0.0014 p.u.
	$\Delta P_{G1}$	0.0118 p.u.	0.0099 p.u.
Area-3	$\Delta f_3$	0.008 Hz	0.005 Hz.
	$\Delta P_{Tie3}$	0.0022 p.u.	0.0023 p.u.
	$\Delta P_{G3}$	0.0025 p.u.	0.0025 p.u.

There are three variables plotted out in the Fig. 7. First one is the frequency variation of area-1 and area-3, second one is AGC tie-line power error of area-1 and area-3, and third one is Generated power deviation in area-1 and area-3. Each figure contains two curves corresponding to two different performance indices. In Fig. 7, the dotted curves show the responses with the performance index ITAE, whereas the solid curves show the responses with the performance index ISE. It is seen that the deadband tends to produce continuous sinusoidal oscillation whereas without deadband the responses are more damped. The superiority of the responses obtained

when the control parameters are set based on minimizing the ITAE is clearly shown. The numerical results of the transient overshoot with respect to different performance indices are presented in Table-2(b). It is clearly evident from this table that the performance of the system with the proposed GA has been improved a lot.

## VI. CONCLUSION

The application of the proposed method to the AGC problem reveals that the system performance is highly improved. The results of this proposed algorithm when compared with the results of other investigators derived in different methods indicate its correctness and effectiveness in finding the optimal AGC parameters of multi-area systems.

## APPENDIX

### Appendix-A

The nominal system parameters are

$$f = 60 \text{ Hz}, T_g = 0.08 \text{ Sec}, T_r = 10.0 \text{ Sec}, H_k = 5.0 \text{ Sec}, K_r = 0.5, T_t = 0.3 \text{ Sec}, 2\pi T_{ki} = 0.05$$

## REFERENCES

- [1] J. Wood, B. F. Woolenber, Power Generation Operation and Control, John Wiley and Sons, 1984.
- [2] O. I. Elgerd, Electric energy Systems Theory – An Introduction, McGraw Hill Co., 2001.
- [3] J. Nanda and B. Kaul, "Automatic generation control of an interconnected power system", *IEE Proc.*, Vol. 125, no. 5, May 1978, pp. 385-390.
- [4] O. I. Elgerd and C. E. Fosha, "Optimum megawatt-frequency control of multi-area electric energy systems", *IEEE Trans. On PAS*, vol. PAS-89, no. 4, April 1970, pp. 556-563.
- [5] M. Aldden and H. Trinh, "Load frequency control of interconnected power systems via constrained feedback control schemes", *Computer and Electrical Engineering*, Vol. 20, no. 1, 1994, pp. 71-88.
- [6] H.J. Kunish, K.G. Kramer and H. D. Dominik, "Battery energy storage – Another option for load-frequency control and instantaneous reserve", *IEEE Trans. Energy Convers.*, vol. EC-1, no. 3, Sept. 1986, pp. 46-51.
- [7] S. Banerjee, J.K. Chatterjee and S.C. Tripathy, "Application of magnetic energy storage unit as load frequency stabilizer", *IEEE Trans. Energy Convers.*, vol. 5, no. 1, March 1990, pp. 46-51.
- [8] Y.L. Karnavas and D.P. Papadopoulos, "AGC for autonomous power system using combined intelligent techniques", *Electric Power System Research*, 62 (2002), 225-239.
- [9] Y.L. Abdel-Magid and M.M. Dawound, "Optimal AGC tuning with genetic algorithms", *Electric Power System Research*, 38 (1997), 231-238.
- [10] S.K. Aditya and D. Das, "Design of load frequency controllers using genetic algorithm for two-area interconnected hydro power system", *Elect. Power Compon. Syst.*, vol. 31, no. 1, Jan. 2003, pp. 81-94.
- [11] Z. M. Al-Hamouz, and H. N. Al-Dowish, "A New Load Frequency Variable Structure Controller using Genetic Algorithms", *Elect. Power Syst. Res.*, vol. 55, no. 1, July 2000, pp. 1-6.
- [12] D. Rerkpreedapong, A. Hasanovic and A. Feliachi, "Robust Load Frequency Control using Genetic Algorithms and Linear Matrix Inequalities", *IEEE Trans. Power Syst.*, vol. 18, no. 2, May 2003, pp. 855-861.
- [13] A.M. Panda, "Automatic generation control of multi area interconnected power system considering nonlinearity due to governor deadband", *Archives of control sciences*, Vol. 7(XLIII), no. 3-4, March 1998, pp. 285-299.
- [14] W. Chan and Y. Hsu, "Optimal control of power generation using variable structure controllers", *Elect. Power Syst. Res.*, vol. 6, 1983, pp. 269-276.





**Gayadhar Panda** is working as an Assistant Professor in the department of Electrical Engineering, IGIT, Sarang, Orissa, India. He was born in Orissa, India, in 1970. He received the B.E. degree in electrical engineering from the Institution of engineers (I), the M.E. degree in electrical engineering from Bengal Engineering College, Shibpur, Howrah, India, and the Ph.D. degree in electrical engineering from Utkal University, Orissa, India, in 1996, 1998, and 2007, respectively.

From 1999 to 2008 he was with the Department of Electrical and Electronics Engineering, Faculty of Engineering, National Institute of Science and Technology, Berhampur, Orissa, India where he is currently a Professor. His research interests are in the areas of stability aspects of power transmission, power electronics, and development of renewable energy. Dr. G. Panda is a member of the IE and ISTE of India.



**Sidhartha Panda** is working as a Professor at National Institute of Science and Technology (NIST), Berhampur, Orissa, India. He received the Ph.D. degree from Indian Institute of Technology, Roorkee, India in 2008, M.E. degree in Power Systems Engineering from UCE, Burla in 2001 and B.E. degree in Electrical Engineering in 1991. Earlier, he worked as an Associate Professor in KIIT Deemed University and also in various other engineering colleges for about 15 years.

He has published above 50 papers in various International Journals and acting as a reviewer for some IEEE and Elsevier Journals. His biography has been included in Marquis' "Who's Who in the World" USA, for 2010 edition. His areas of research include power system transient stability, power system dynamic stability, FACTS, optimization techniques, model order reduction, distributed generation, image processing and wind energy.

**C. Ardil** is with National Academy of Aviation, AZ1045, Baku, Azerbaijan, Bina, 25th km, NAA