

Performance Evaluation of A Stratified Chilled-Water Thermal Storage System

M. A. Karim

Abstract—In countries with hot climates, air-conditioning forms a large proportion of annual peak electrical demand, requiring expansion of power plants to meet the peak demand, which goes unused most of the time. Use of well-designed cool storage can offset the peak demand to a large extent. In this study, an air conditioning system with naturally stratified storage tank was designed, constructed and tested. A new type of diffuser was designed and used in this study. Factors that influence the performance of chilled water storage tanks were investigated. The results indicated that stratified storage tank consistently stratified well without any physical barrier. Investigation also showed that storage efficiency decreased with increasing flow rate due to increased mixing of warm and chilled water. Diffuser design and layout primarily affected the mixing near the inlet diffuser and the extent of this mixing had primary influence on the shape of the thermocline. The heat conduction through tank walls and through the thermocline caused widening of mixed volume. Thermal efficiency of stratified storage tanks was as high as 90 percent, which indicates that stratified tanks can effectively be used as a load management technique.

Keywords—Cool Thermal Storage, Diffuser, Natural Stratification, Efficiency Improvement, Load management.

I. INTRODUCTION

A large proportion of the annual peak electricity demand, reaching up to 70% in commercial and office buildings, goes to satisfying the air conditioning load [1]. Most air conditioning systems in commercial and office buildings are operated at the daytime and contribute to the daytime demand peak. The peak cooling demand is greatly in excess of the daily average load. Unlike other building electric uses, cooling incurs a peak demand for only a short period of a day (Fig. 1). Since utilities must meet this demand, they must have larger capacities that go unused most of the time. The need to meet peak demand requirements creates more pressure on the utility companies for constructing new generation facilities, thus creating pressure for higher customer rates. Technology for cool thermal storage is the most advanced, and appears to have the greatest potential of all presently available alternatives to the construction of new generating facilities. Thermal energy storage (TES) is a way to supply the cooling capacity required by a building while shifting electric utility demand and energy use from on peak to off-peak hours. Today's energy situation is such that cool storage has emerged

M.A. Karim is with the School of Engineering System, Queensland University of Technology, QLD 4001, Brisbane, Australia (corresponding author: fax (617) 3138 1516; e-mail: azharul.karim@qut.edu.au).

as most advanced, cost-effective space cooling technology, particularly due to the utility established customer incentives.

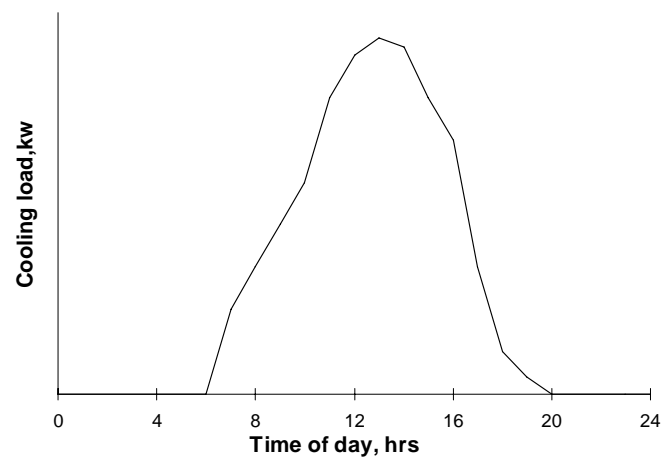

Fig. 1 Typical daily cooling load profile

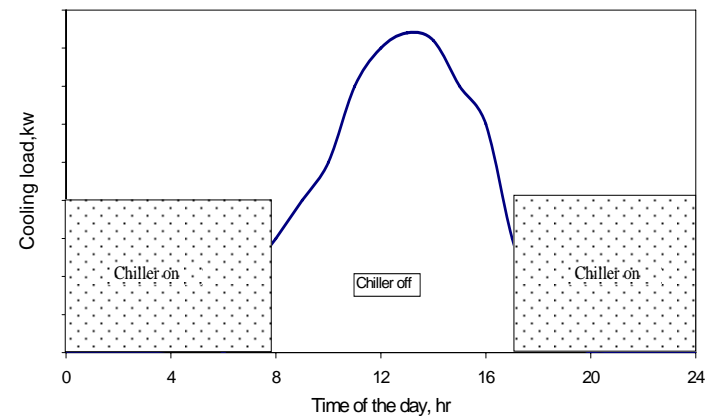

Fig. 2 Basic thermal storage operating strategy

Fig. 1 illustrates a typical cooling load profile and Fig. 2 illustrates the use of thermal energy storage and clearly demonstrates how the peak load is shifted to the off-peak. Besides shaving the peak load, TES has many other benefits. As off-peak period is much longer than peak period and chillers can run at full capacity during charging the storage tank, TES air-cooling system requires smaller capacity chiller. Often, money saved by downsizing the chiller can offset the cost of adding a cool storage. As chillers run at nighttime when outside temperature is lower than daytime, chiller cycle efficiency is higher.

A number of concepts have been developed for cold storage and many storage materials were tested and/or used [2]. The possible approaches for cool thermal storage can be characterized according to storage medium and storage mode. Storage medium includes chilled water, ice and eutectic salt phase change materials and storage mode may be classified as partial and full storage systems.

Although all three storage mediums are applied, water, due to its abundance, low cost, high specific heat and benign character, is most widely used storage medium in thermal storage applications. Chilled water storage systems have some significant advances over other systems. These include:

- ◆ Conventional chiller, piping and air-handling units can be employed, which means no need for special equipment. This gives an advantage to employ TES in existing systems.
- ◆ Controls are simpler than those associated with ice and phase change storage systems.
- ◆ Ice storage systems are generally limited in size to commercially available storage modules but chilled water systems, on the other hand, are not limited in size. The component arrangements are more flexible and they have been found to be more practical for large building applications.
- ◆ Can serve double duty by providing a water reservoir for fire protection.
- ◆ Can serve as standby source for cooling in case of power outage.
- ◆ Less costly than other types of TES.

The separation of the warm and cold water in the storage tank is the key factor in water storage systems. This separation can be achieved through various methods, namely stratification, multiple tank, membrane or diaphragm, labyrinth and baffle etc. Stratified storage tank, as the name implies, stores warm and cold water in the same tank and is separated by natural stratification due to their density difference and has similar or better performance compared to other types [3]. If mechanical disturbances are kept to a minimum, temperature differences are properly controlled, and chilled water is introduced at the bottom of the tank, density differences will create a region of vertical temperature gradient, called thermocline, that lies between the two water masses.

Prospect of TES is brighter in tropical countries as cooling is necessary all round the year and thus payback period for the larger initial investment on storage tank is shorter. The objective of this study was to experimentally investigate the thermal performance of chilled water storage system towards achieving an efficient storage system. A chilled water storage air conditioning system was designed, constructed and tested. A new octagonal type diffuser was developed. Thermal performance of the system was studied under wide range of operating conditions. This paper presents the key findings of this study.

II. ANALYSIS

The net rate of energy transfer to or from the storage tank due to water flow through the inlet and outlet is termed as instantaneous capacity. For charging and discharging, instantaneous capacity may be expressed as

$$q = \dot{m} c_p (T_h - T_l) \quad (1)$$

where \dot{m} , T_h and T_l all may be the function of time. During charging T_h depends on the temperature distribution in the tank at the start of charging and T_l is determined by the outlet temperature of the chiller. During discharging T_l depends on the temperature distribution in the tank at the start of discharging and T_h is determined by the outlet water temperature at the cooling coils. Integrated capacity is the total energy flow to or from the storage due to water flow through the tank during some period of time. Mathematically it can be expressed as:

$$Q = \int_0^{t_f} q dt \quad (2)$$

Substituting equation (1) and noting that mass flow rate can be determined at either the inlet or outlet port by $\dot{m} = \rho AV$ gives:

$$Q = \int_0^{t_f} \rho c_p (T_h - T_l) AV dt. \quad (3)$$

where AV is the volume flow rate through the storage. Now, the incremental volume flow, dv , in any time increment dt can be written as:

$$dv = AV dt$$

hence equation (3) may be rewritten as:

$$Q = \int_0^{v_f} \rho c_p (T_h - T_l) dv \quad (4)$$

where v_f is the total flow volume during the period of interest.

Storage efficiency is defined as the ratio of cooling effect removed from the storage during a single, complete discharge cycle to the cooling effect deposited during the immediately preceding complete charge cycle [4]. It can be expressed as:

$$\eta_{st} = \frac{Q_d}{Q_c} \quad (5)$$

Diffuser Design

Proper design of the water distribution system in the tank is important for achieving thermal stratification. Methods of analysis and design of inlet and outlet diffusers are by no means complete at present, because of the complex nature of the characteristics of the inlet and outlet water. Inlet and outlet diffuser design is still of great concern. Mixing and turbulence

during the charging and discharging is the major contributor to the loss of thermodynamic availability.

The diffusers should introduce water to the tank uniformly and at a low-velocity so that buoyancy forces create and maintain the thermocline. Diffusers in stratified chilled water storage must form, or reform, a thermocline with minimum mixing between warm and cold water, and then ensure that the thermocline is not impaired by subsequent mixing. Attention has to be given to maintaining uniform velocities through the diffuser openings, minimizing velocities and other disturbing factors that are greatly dependent on inlet and outlet flow arrangements i.e. the diffuser design. High velocity will overcome the buoyancy forces causing mixing. Nonuniform flow through the diffuser openings can cause swirling in the storage tank. Uniform discharge velocity is achieved when the static pressure throughout the interior of the diffuser piping is uniform [5]. While absolute uniformity is difficult to achieve, it can be approximated by making the total opening area in any diffuser branch half the cross-sectional area of the branch pipe [6].

The extent to which mixing occurs naturally in a stratified tank as well as the design improvements that can be made to minimize it were examined by Baines et al. [7]. Several inlet systems were used by several investigators to enhance the thermal stratification in storage tanks [3, 8]. It is reported in the literature that radial disk and circular diffusers are geometrically suited for cylindrical tanks, whereas slot and H-type diffusers are suitable for square and rectangular tanks [9]. In this study an octagonal diffuser was introduced.

The thermocline formation can be ensured by designing the diffusers with the appropriate Froude number and by properly sizing diffuser openings [5]. Froude number is the dimensionless ratio of the inertia force to the buoyancy force acting on a fluid. In their work that established the importance of the inlet Froude number in thermocline formation, Yoo et al. [10] verified that with a Froude number of 1 or less, the buoyancy force in the inlet flow is greater than the inertial force, and gravity current is formed. For higher Froude number, the inertial force creates jet-like flow immediately downstream of the inlet, resulting in unnecessary mixing. The Froude number (Fr) is defined as [11]:

$$Fr = \frac{u}{[g\beta(T_w - T_c)L]^{1/2}} \quad (7)$$

The velocity u can be calculated from the known total volume flow rate and the calculated (or measured) total diffuser flow area. The characteristic dimension L of the diffuser is sometimes difficult to determine. For the radial diffusers it is presumably the spacing between the disc and the tank bottom. For linear diffusers it is assumed to be the slot height and for circular and hexagonal diffusers characteristic dimension has been assumed to be the height of the top of the openings above the floor [4]. In this study the characteristic height of the octagonal diffuser was assumed to be similar to hexagonal diffusers.

III. TEST FACILITY, INSTRUMENTATION, AND PROCEDURE

Performance evaluation of thermal energy storage is important for optimal sizing of tank for a given task. For TES applications, experimental study is important to determine actual performance of the system under the meteorological conditions of the place of interest.

A. Experimental Facility

A test system was designed and constructed to investigate the performance of a stratified thermal storage tank. The major components of the test system were an insulated cylindrical tank, a refrigerating unit comprising of an evaporator, an air-cooled condenser and a reciprocating type compressor, a water heater, and two water pumps and diffusers. The system was designed for a cooling load of 4.10 kW. The schematic of the experimental setup is shown in Fig. 3.

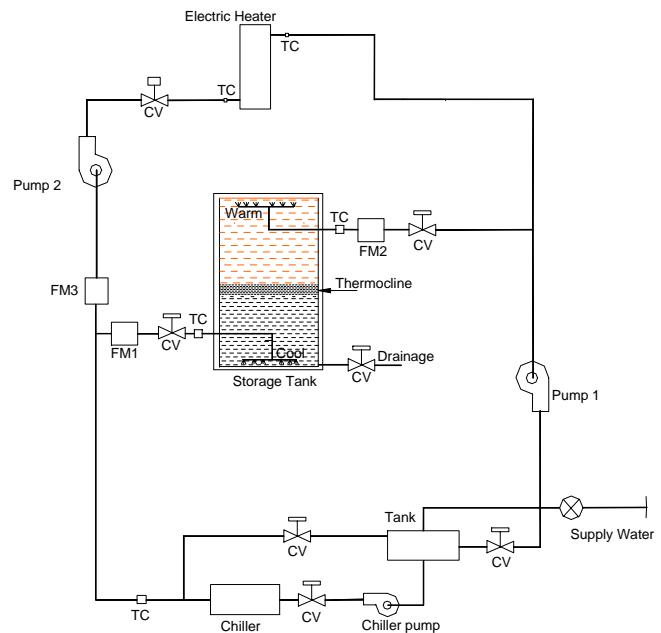

Fig. 3 Schematic of the test system

An air-cooled 1.5 ton refrigerator capable of supplying 4°C water at the maximum flow rate of 8.0 L/min, was installed. The building load was simulated with an electric heater. The heater was used in place of room load in order to achieve ideal test conditions and better control.

As mentioned earlier, octagonal diffusers were used in this study. The prime consideration in the design of the diffusers was to ensure uniform distribution of liquid over the whole cross-sectional area of the tank and smooth penetration/extraction of liquid in order to minimize these hydrodynamic disturbances. It was found that if the opening area in each diffuser arm is kept half of the pipe cross sectional area suggested by Hudson [6], Fr no. is greatly in excess of 1 at design flow rate. Therefore a tradeoff between Fr number and pressure drop (flow opening area) is necessary.

It was decided to design the diffusers satisfying the requirement of Froude no (equal to 1 or less). It was also decided to test the designed diffusers at flow visualization before using them in full scale tests in order to investigate the formation of a thermocline. Two octagonal diffusers with different flow opening areas were constructed from 20mm PVC pipes. The objective of designing two diffusers was to test the influence of Froude number (i.e. flow velocity) and pressure drop. The first diffuser (diffuser A), had four opening holes in each arm having a total opening area of 45 cm² (flow opening area in each arm = 1.8 times the pipe cross sectional area) and the second one (diffuser B) had two openings in each diffuser arm with total opening area of 22.4cm² (flow opening area in each arm = 0.89 times the pipe cross sectional area). Thus one diffuser had double opening area (hence half the Froude number) compared to the other one. Octagons were formed by eight straight sections, 23.8 cm each, connected with 45° elbows.

Equally sized, shaped, and spaced slot openings were cut into one side of each straight section. The use of arc-shaped slots ensured uniform subdivision of flow in vertically downward as well as both radially inward and outward directions as it exits the diffuser pipe.

B. Instrumentation

Two vertical strings of calibrated thermocouples, one on the side-wall and the other at the centre of the tank were installed. In each string 38 calibrated thermocouples, at 5cm interval, were installed in order to monitor the movement of the thermocline. Calibrated thermocouples were also installed at inlet and outlet of the storage tank, inlet and outlet of the heater and inside the water tank of the chiller. Calibrated electronic flow meters were used to measure water flow rate to and from the tank. Temperature controllers were used to control heater and chiller outlet water temperatures. Thermocouple and flow meter readings were recorded by a data acquisition system.

C. Test Procedure

As mentioned earlier, two pairs of diffusers with different opening area (hence the Froude no.), number of openings and spacing were constructed. Colored chilled water was introduced through the diffusers in a tank full of clear water to visualise the flow pattern and mixing. The tests usually started with uniform water temperature in the tank. Flow visualization tests showed that diffuser B introduced water more uniformly and gently hence caused less mixing. Therefore, diffuser B was used in the experiments.

In the tests, nominal inlet temperature during charging varied between 4.5 and 6.0°C while that during discharging varied between 16 and 19°C. During these tests the flow rates varied between 3 and 8 L/min. Thus the flow rates during both charging and discharging covered a of range design conditions. In the experiments, discharging was terminated when the tank outlet temperature reached its maximum useful value for normal air-conditioning system, which is about 9-10°C.

IV. RESULTS AND DISCUSSION

Experiments were conducted under different conditions in which a cooling system is likely to operate. Many tests involving single cycles of operation and a few involving partial cycles were performed to evaluate the performance for a wide variety of test conditions. However, this paper reports the results of the complete cycle tests only. Flow rates during these tests varied between 3 L/min and 8 L/min. Results of some selected tests are presented here.

Figs. 4 and 6 show the temperature distributions at different time intervals during charging at 4.2 L/min and 5.4 L/min flow rates respectively. In these plots the temperature at any level was obtained by averaging the temperatures from two thermocouples at the same level in the vertical strings of thermocouples. Formation of thermoclines during charging is clearly seen in the figures. It is also apparent that the thermocline was very stable throughout the charging period. These figures show that thermoclines had similar shapes at both flow rates. The only significant difference was that the water below the thermocline immediately after it formed was warmer at 5.4 L/min, which indicates somewhat greater mixing occurred. But the depth of the mixed region was not much larger, since the temperature below the thermocline dropped rapidly to its final value.

Comparison of temperature distribution at different flow rates during discharging exhibits similar trends. Figs. 5 and 7 present the temperature distributions during discharging in the tank at 4.3L/min (corresponding to 4.2 L/min charging) and 5.28 L/min (corresponding to 5.4 L/min charging) respectively. The thermocline during the discharging was thicker than that of charging due to prior existence of a thin temperature gradient region at the top of the tank.

Fig. 8 shows charge inlet and discharge inlet and outlet temperatures for whole charging (at 4.2 L/m) and discharging (at 4.3 L/m) period. It can be seen that the outlet temperature rose slowly during discharging. Temperature rose rapidly near the end of discharging due to the approach of the thermocline to the outlet. Heat transfer from the tank walls and floor and by conduction through the thermocline after its formation contributed to this rise. Similar trend was observed in all other tests.

Although very rapid charging of thermal energy storage is unlikely, since this implies a large amount of excess chiller capacity, nevertheless testing was performed at flow rates considerably in excess of design condition. The results of 8.0 L/min charging and 8.1 L/min discharging are presented in Figs. 9 and 10 respectively. The results show that at 8.0 L/min flow rate there was a considerably greater mixing. The thermocline that formed in this test was thicker compared to 4.2 L/min and 5.4 L/min flow rates. The bottom knee of the thermocline at Fig. 9 was more rounded than that of Figs. 4 and 6. Despite the differences in initial thermocline shape between 8.0 L/min and 4.2 L/min flow rates, the final temperature distributions became closer in shape. It appeared that the effect of increased mixing during thermocline formation at 8.0 L/min was greatly offset by reduced conduction because of less time of charging. However, the overall temperature of water in the tank was higher at 8.0

L/min, which was evidenced from the final temperatures of Figs. 9 and 4. Higher flow rate also showed more mixing during discharging as shown in Figure 10. Mixing produced a gradual rise in outlet temperature during discharging, which reduced the efficiency considerably.

Many more tests (Table I) were conducted at different flow rates. Thermal performances of the storage tanks at different flow rates are summarized in Table I. Tests were performed at flow rates that resulted in charge times ranging from 2.1 hour to 5.8 hours and discharge times ranging 2.13 to 4.16 hours. It can be seen from the table that TES system developed exhibited attractive performance such as cycle thermal efficiencies up to 90% if they were completely or almost completely discharged. The efficiency was highest (90%) at the flow rate of 4.2 L/min and lowest (82%) at 8.0 L/min. From the wide range of tests it was evidenced that chilled water tank stratified at typical operating temperatures. In these tests, an initial thermocline thickness between 10 cm and 20 cm was observed. At flow rate 4.2 L/min initial thermocline thickness was 10cm and it widened to 20 cm as charging proceeded. At flow rates 8.0 L/min, the initial thickness was about 20 cm or approximately twice the thickness for lower flow rates; and the vertical distance from the inlet diffuser at which the thermocline first formed was significantly greater, which can be seen in Fig. 9. Flow rate of chilled water through the diffuser openings is one of the major factors influencing the formation of thermocline.

V. CONCLUSION

From the test results it can be concluded that chilled water thermal storage tanks consistently stratify well at operating conditions corresponding to typical design conditions. Thermal efficiency up to 90% can be achieved from TES tanks. Diffuser design and layout and flow rate primarily affect the mixing near the inlet diffuser. Diffusers should be designed based on Froude number =1 and equal pressure drop. Lower Fr. numbers causes unequal pressure drop and hence unequal flow from different openings. Octagonal diffusers have better performance than distributed diffusers. Subsequent to the thermocline formation, the heat transfer through the walls and through the thermocline is mainly responsible for widening of the thermocline. During thermocline formation at the start of charging and discharging the extent of mixing has great influence on the shape of the thermocline and overall efficiency. For achieving best efficiency charge-discharge cycle should be complete. Incomplete discharging (partial discharging in one discharge cycle), which involves relatively longer residence time of cool water in storage, produces a significant decrease in thermal efficiency as temperature of the chilled water in the tank increases because of heat conduction through the walls.

NOMENCLATURE

A Opening area of inlet port or diffuser
 c_p Specific heat of water
 g Acceleration due to gravity
 L Characteristic dimension of diffuser

\dot{m} Mass flow rate through the tank
 q Instantaneous capacity of the tank, Flow rate per unit diffuser length
 Q Integrated capacity of the tank, Maximum flow rate
 Q_c The integrated capacity for charging
 Q_d The integrated capacity for discharging
 T Temperature
 T_c Temperature of the cooler water in the tank
 T_h Fluid temperature at high port of the tank
 T_l Fluid temperature at the low port
 T_w Temperature of the warmer water in the tank
 u Average velocity of the flow at diffuser opening
 V Velocity of fluid at inlet or outlet port of the tank
 v_f Total volume flow during the period of interest
 β Coefficient of volumetric expansion
 η_{st} Efficiency of the storage tank
 ρ Density of water

REFERENCES

- [1] Karim, M. A, Musa, M. N and Ghazali, N. M. Design procedure of stratified chilled water storage air-conditioning system. Malaysian Science and Technology Congress, 1995, pp. 212-220.
- [2] Guyer, E.C. and Brownell D.L. Review of heat storage materials. EPRI report, EPRI, EM-3353, December 1983.
- [3] Wildin, N.W., and Truman, C.R., Evaluation of stratified chilled water storage techniques. EPRI report, EPRI, EM-4352, December 1985.
- [4] Wildin, M.W., and Truman, C.R. Performance of Stratified Vertical Cylindrical Thermal Storage Tanks, Part I: Scale Model Tank. ASHRAE Technical Data Bulletin 1989; 5 (3).
- [5] Dorgan, C. E. and Elleson, J. S. Design guide for cool thermal storage, American Society of Heating, Refrigerating and Air-Conditioning Engineers, ASHRAE, Atlanta, Ga. 1994.
- [6] Hudson, H.E, Uhleer, R. B and Bailey, R. W. Dividing flow manifolds with square edged laterals. Journal of Environmental Engineering Division, ASCE, vol. EE4 (August): 745-755.
- [7] Baines, W. D., Martin, W. W, and Sinclair, L. A. On the design of stratified water thermal storage tanks. ASHRAE Transactions 1982; 88 (2): 426-439.
- [8] Cole, R. L., and Bellinger, F. O. Thermally stratified tanks. ASHRAE Transactions. 1982; 88 (2):1005-1017.
- [9] Gross, R.J. An Experimental Study of Single Medium Thermocline Thermal Energy Storage, ASME paper 82-HT-53;1982.
- [10] Yoo, J., Wildin, M. W., and Truman, C. R. Initial Formation of a Thermocline in Simplified Storage Tanks. ASHRAE Transactions. 1986; 92 (2): 280-292.
- [11] Mackie, E. I and Reeves, G. Stratified Chilled-Water Storage Design Guide, EPRI, Final report, EPRI, Pleasant Hill, CA. 1988.

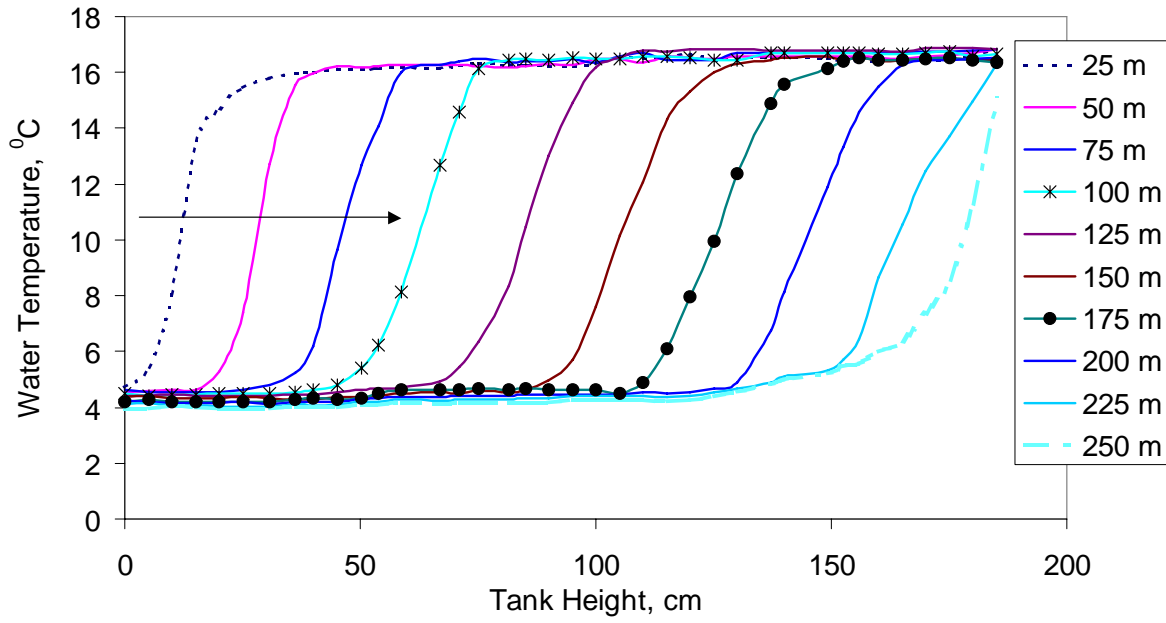

Fig. 4 Temperature distribution in the tank during 4.2 L/m charging

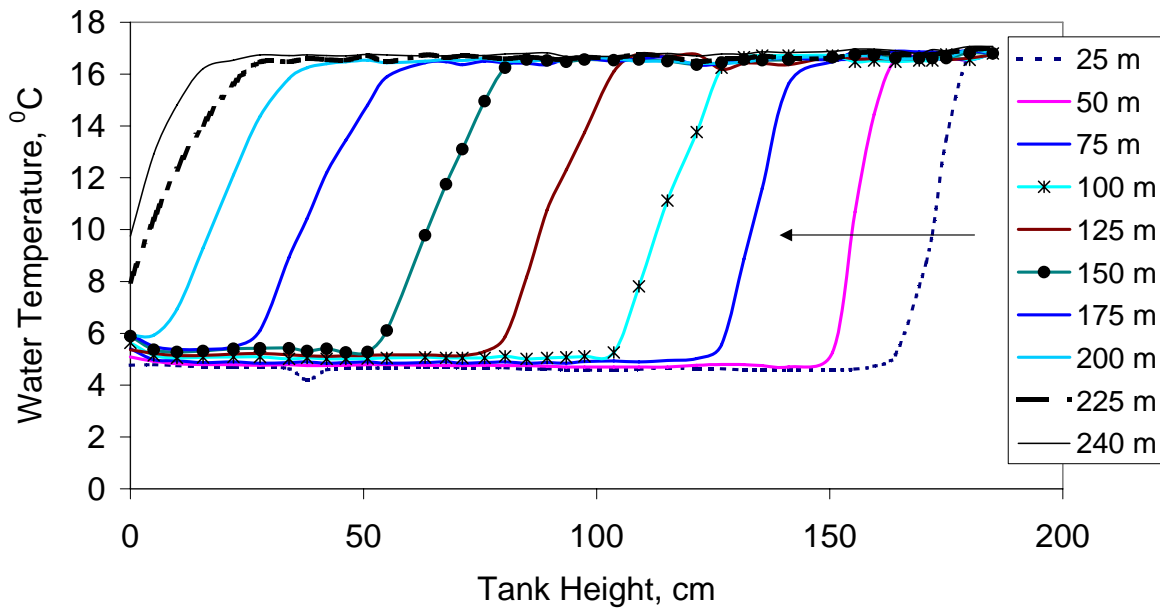

Fig. 5 Temperature distribution in the tank during 4.3 L/m discharging

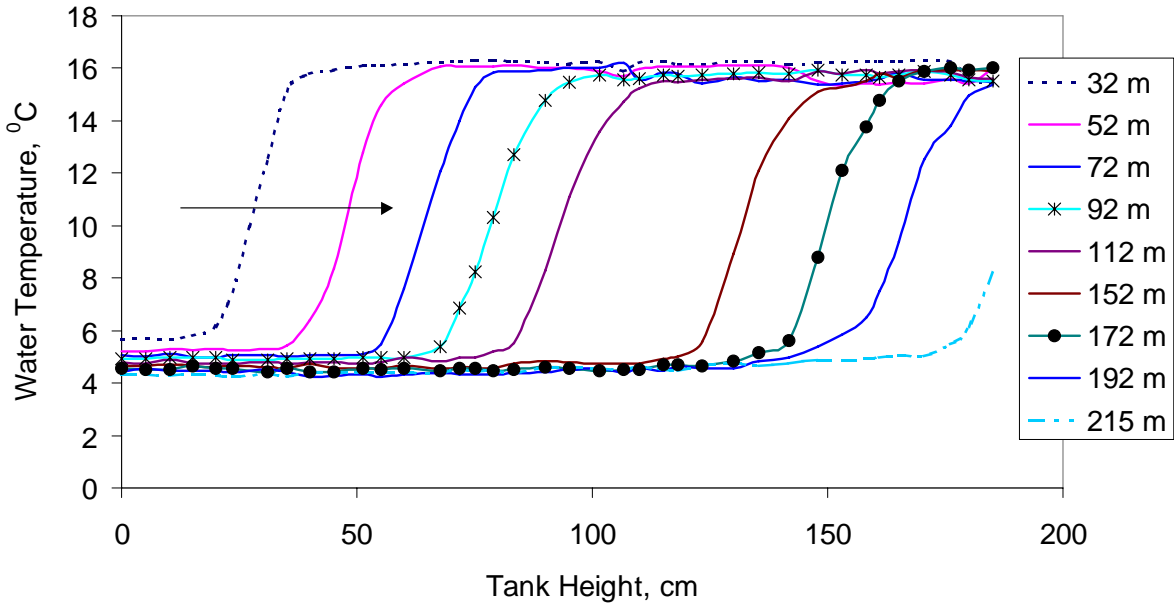

Fig. 6 Temperature distribution in the tank during 5.4 L/m charging

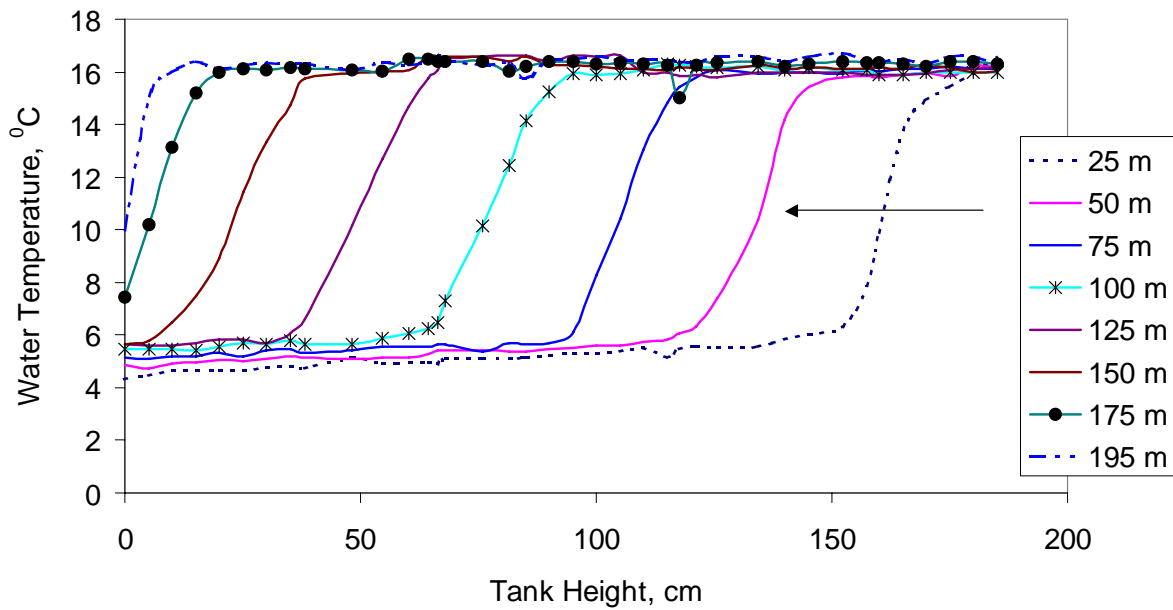

Fig. 7 Temperature distribution in the tank during 5.28 L/m discharging

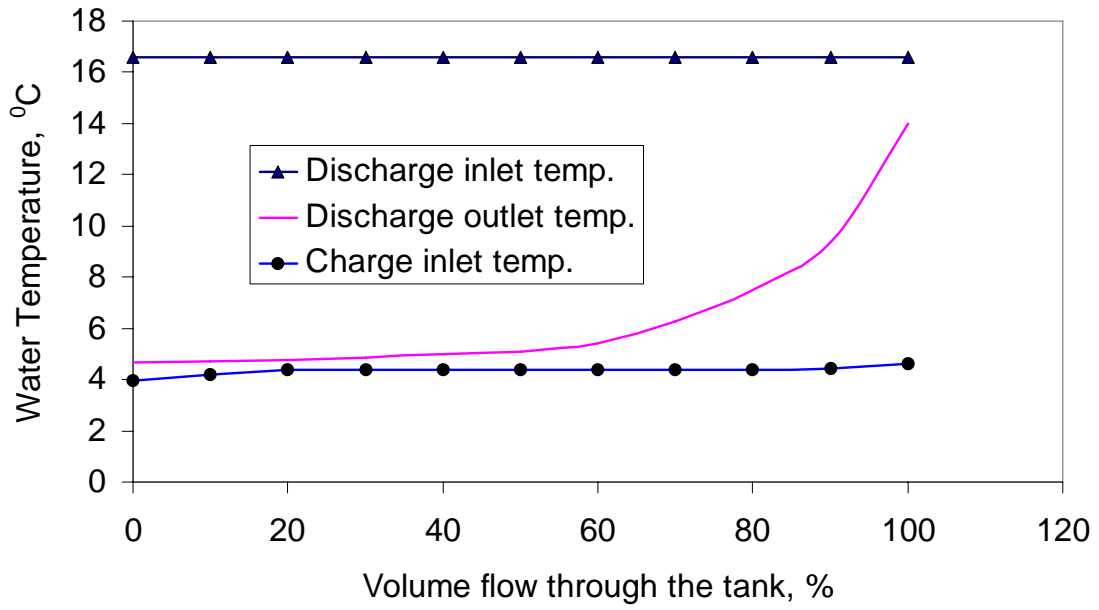

Fig. 8 Outlet and inlet temperatures during 4.2L/min charging and inlet temperature during 4.3 L/min discharging

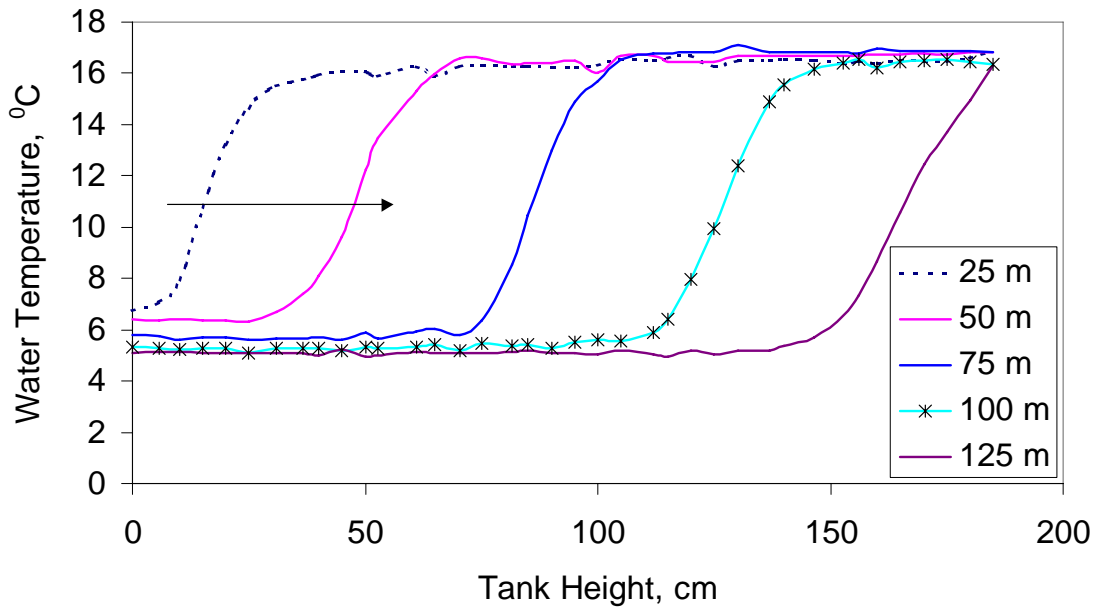

Fig. 9 Temperature profiles during 8.0 L/min charging

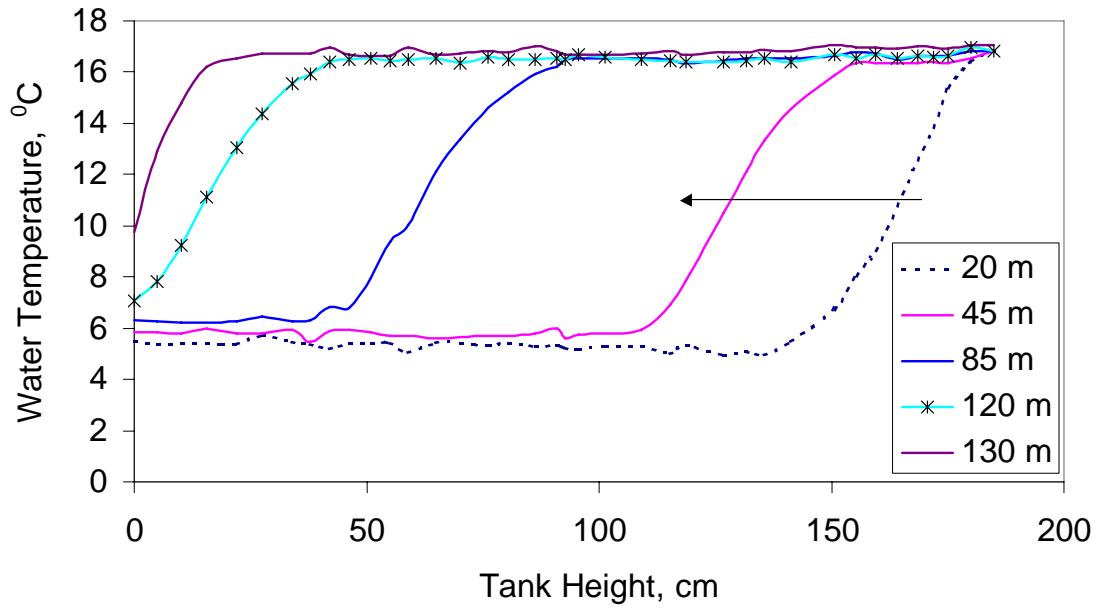

Fig. 10 Temperature profiles during 8.1 L/m discharging

TABLE I
 SUMMARY OF RESULTS FOR COMPLETE CHARGING AND DISCHARGING CYCLE TESTS

Test	Flow Rates		Total Flow		Integrated Capacity		Cycle efficiency
	Charge L/m	Discharge L/m	Charge L	Discharge L	Charge kWh	Discharge kWh	%
	3.6	4.2	1130	1020	12.63	10.73	85
B	5.4	5.28	1161	1035	13.92	12.25	88
C	4.2	4.3	1110	1029	13.44	12.10	90
D	3.8	5.95	1116	1027	14.36	12.35	86
E	3.8	5.6	1115	1022	15.33	13.11	85.5
F	8.0	8.1	1125	1025	14.45	11.85	82