

# Concept for a Multidisciplinary Design Process—An Application on High Lift Systems

P. Zamov, and H. Spangenberg

**Abstract**—Presents a concept for a multidisciplinary process supporting effective task transitions between different technical domains during the architectural design stage.

A system configuration challenge is the multifunctional driven increased solution space. As a consequence, more iteration is needed to find a global optimum, i.e. a compromise between involved disciplines without negative impact on development time. Since state of the art standards like ISO 15288 and VDI 2206 do not provide a detailed methodology on multidisciplinary design process, higher uncertainties regarding final specifications arise. This leads to the need of more detailed and standardized concepts or processes which could mitigate risks.

The performed work is based on analysis of multidisciplinary interaction, of modeling and simulation techniques. To demonstrate and prove the applicability of the presented concept, it is applied to the design of aircraft high lift systems, in the context of the engineering disciplines kinematics, actuation, monitoring, installation and structure design.

**Keywords**—Systems engineering, multidisciplinary, architectural design, high lift system.

## I. INTRODUCTION

TECHNICAL processes are used to transform system requirements into a product providing required services and to sustain the provision of those services, (see Fig. 1).

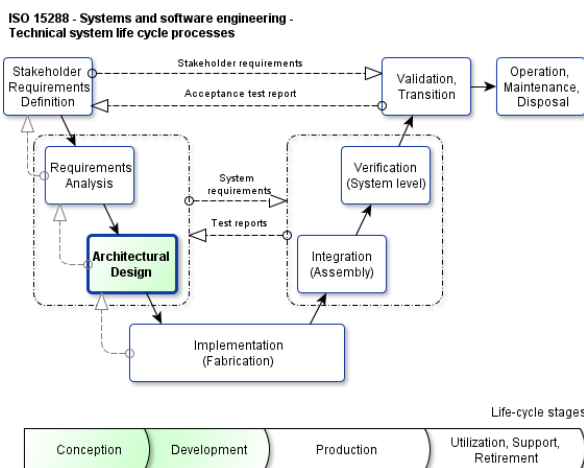

Fig. 1 System Life-cycle processes (based on [6])

P. Zamov is with the German Aerospace Center, Lilienthalplatz 7, 38108Braunschweig, Germany (phone: +495312952776; e-mail: peter.zamov@dlr.de).

H. Spangenberg is with the German Aerospace Center, Lilienthalplatz 7, 38108Braunschweig, Germany (phone: +495312952637; e-mail: holger.spangenberg@dlr.de).

The systems engineering technical processes are applied to specify, design, and verify the system to be built [5], [9]. An integrative process, capable to transform the requirements in an appropriate system, starts with the Requirements Analysis, which is one of the most essential tasks to succeed projects[6].The subsequent processes aim to derive products and services with an acceptable level of functionality which possess the required availability, cost effectiveness, maintainability, and other non-functional qualities. A detailed and mature set of specifications is produced, in particular by iterative verification and validation, supporting the design traceability, as indicated by grey dash arrows in Fig. 1.

The Architectural Design phase aims to synthesize a solution that satisfies functional and non-functional requirements. During the Architectural Design phase, functional and non-functional requirements are systematically translated in an appropriate system solution by involving different technical disciplines including typically kinematics, structure design, stress, installation, actuation and control. The state of the art practice for the Architectural Design is not static and evolves to deal with increasing demands in the mechatronic system design.

It can be observed that the main technical and management risks are caused by uncertainties of inter-disciplinary dependencies and from a lack of effective and efficient integration of involved disciplines. In order to address these drawbacks, this article aims to present a concept for multidisciplinary process and design risk minimization, involving a continuous model-based approach, in particular for mechatronic multi body systems. This concept will be applied to the design of aircraft high lift systems.

## II. MAJOR ENGINEERING TASKS AND NEEDS

Process sequences are characterized by the relation between the development stages and incorporate feedback. Examples of such sequences are the Waterfall model and the Vee model.

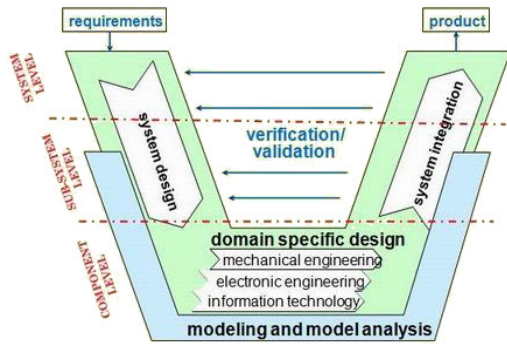

Fig. 2 Design methodology for mechatronics systems as Vee diagram as proposed by VDI 2206 [11]

Main approach of the Vee model is the sequence of Top-Down architecture decomposition & definition and Bottom-Up architecture integration by involving verification loops at every design level as shown in Fig. 2. The set of internal processes within a life cycle stage is applied with the common goal of satisfying the exit criteria for that stage or the entry criteria of the formal progress within the next stage. Exit criteria or requirements are used to devise an integration and verification strategy for the process [6].

#### A. State of the Art in Mechatronics Engineering

Typically, a state of the art design process for mechatronic systems follows a sequence of four main steps, as follows:

1. Kinematics & 3D structure design
2. Stress & Space design
3. Control & Actuation
4. Installation

The process starts with kinematics, straight followed by structure design. In a second stage, the structure design is refined by stress analysis closely followed by space allocation considerations. Thirdly, a comprehensive control design, including also actuation, monitoring and protection is achieved. At the end, mechanical and electrical installation design is performed. This “4 steps design model”, as shown in Fig. 3, is a representation of design sequence often applied in robotics and other mechatronic areas.

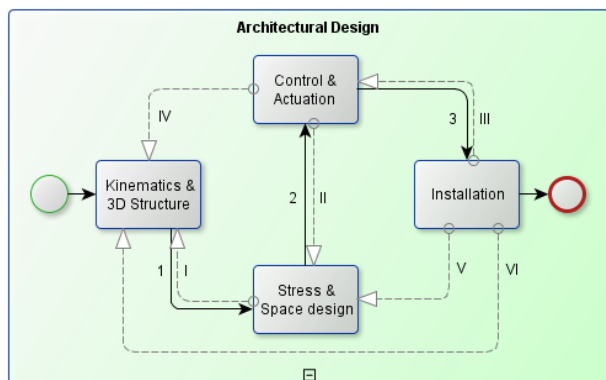

Fig. 3 Design sequence during the architectural design stage for multi body mechatronic systems

More in detail, the system development typically starts with analysis of motion requirements and constraints. A kinematics design is done in an iterative way for each relevant motion plane in an order depending on the motion plane significance [7]. Following, the structure design focuses on the high iterative 3D geometry design of mechanisms and fixed components, initially dimensioned by experience and assumed part stress characteristics.

Part dimensions, which are set in an intuitive way during structure design, are refined successive during and after stress analysis. Boundary conditions for the stress analysis are set by interface loads and motion constraints, enabling static and dynamic analysis [10]. The realistic 3D models are an input for consideration of space allocation requirements, parts assembly sequences, etc. Space analysis considers space allocation models, clearance, e.g. a minimal distance between moving parts, safety rules, supportability and maintenance aspects. Sweep volumes can consider effects coming from structural deformations and final space allocation models are used to analyze also non-linear effects which can be caused e.g. by parts bending. An advanced space allocation design should further include a zonal safety analysis of the system, considering components functionality, wiring, etc.

The control system design defines at first an architecture regarding the actuation as well as monitoring and protection mechanisms. Based on that, the system response on failures is systematically analyzed and proper means which means specific design rules are defined, searching for an optimal combination of system functionality and reliability. Safety analysis is performed to validate the system architecture by consideration of functional interdependencies, components availabilities, failure probabilities and effect classification. After that, the detailed design of subsystems, e.g. the controller design, is realized.

After the control & actuation design, the installation design proceeds with design considerations regarding safety, system maintainability, components accessibility, wiring, operational validation for different system conditions, etc. The installation design itself often starts after having performed primary stress analysis for the most relevant parts.

The presented process has an iterative nature that supports learning and continuous improvement. However, complexity can lead to unexpected and unpredictable behavior of systems [4]; hence, one of the objectives is to minimize undesirable consequences by definition of required iterations.

#### B. Process Analysis

Following disadvantages can be captured regarding the presented task sequence (see Fig. 3):

1. 3D structure design is often started before a 3D kinematics model is being validated regarding motion precision. This is an important process management issue especially in the case of systems with many degrees of freedom and complex 3D motion.
2. Installation analyses are not sufficiently linked to structure design. The early efforts applied in 3D structure

design are restricting the possible design solution for installation.

3. Control analyses are not sufficiently integrated in the kinematics concept, e.g. adequate motion sensing or monitoring. An optimization of the kinematics, e.g. towards relevant loads or monitoring mechanisms is suboptimal due to late actuation system integration. The definition of monitoring and protection concepts after actuation design leads to uncertain definition of relevant (failure) loads.
4. Safety analysis is not clearly integrated in the design and leads to possible design changes late in the development process.

Three main iterations can be noticed: during stress and initial installation design, changes can be required in structure design as well as in kinematics design due to space allocation, loads consideration, or even necessary changes in joint positions or arrangements of a mechanism (see iteration No. I in Fig. 3). Secondly, the control architecture can lead to iterative alteration of stress design, e.g. due to estimated interface loads after analysis of system response with consideration of monitoring and protection (see iteration No. II, Fig. 3). The installation design is influenced by certification rules and maintenance recommendations, e.g. zonal safety, components accessibility, etc. Since these tasks are mainly discussed in the early system architecture design with special focus on control and actuation, an early feedback from installation to the system architecture is very important (see iteration No. III, Fig. 3).

Beside these relative close feedbacks some late feedbacks can be observed too:

1. Late feedback from installation analysis to structure design and/or kinematics design (see iteration No. VI) caused by too early iterations between stress and structure design without consideration of installation.
2. Late feedback from installation design to stress and space design (see iteration No. V) leads to time consuming iterations and late prediction of weight.
3. Late feedback from actuation analysis / control analysis to kinematics design (see iteration No. IV). Besides, requirements for monitoring can have influence on system design and thus kinematic concepts.

Typically, task and feedback transitions take the form of questions with respect to requirements, analyzed risks or opportunities. Such questions should be resolved in a very integrative manner, thus even before completing concept activities of a process. Unfortunately, the combination of the effects mentioned above and the time-wasting long iterations due to the complex inter-dependencies in the context of the involved disciplines leads to not naturally convergent optimization. The variety of design solution options cannot be explored in a time efficient way, leading to a suboptimal solution. A high design risk arises due to missing integration concepts for activity groups, e.g. for kinematics and structure design, stress and installation design, and control & actuation design. A design risk reduction should be enhanced by early

concept validation mechanisms, ensuring that an optimized design output can be achieved within the preliminary design phase. This goal is challenging in projects with frequently changing boundary conditions, as can be observed in a multidisciplinary design [1].

Due to possible uncertainty of technical requirements at the beginning of a multidisciplinary project, the interaction and synergy of sub-systems should be explored and exploited at every development stage. Additionally, the process should take into account also the project progress and allocate the intensity of discipline task in the context of preliminary and detailed design phases.

### III. PROCESS CONCEPT

Necessary adoptions of requirements or functional specifications could arise at any design step within the architectural design and may alter or constrain design decisions associated with previous or superior requirements. Therefore, the new process concept should provide a basic process structure based on a holistic view on the system design and further enable a harmonization of the involved disciplines by applying a process sequence capable for the preliminary and detailed design phases.

The *Architectural Design* is therefore split into *Logical* and *Physical Architectural Design* (see Fig. 4) in a particular new understanding of these terms. The main intensity of Logical Design is assigned to the preliminary design phase, whereas the main focus of the Physical Design is assigned to the detailed design phase. This concept complies with the front loading concept by concentration of the intensity of the engineering effort to the early design stages.

The primary goal of the Logical Design is the integration of the required functions in a logical way which leads to the system architecture, to allocate appropriate system elements to these functions and to describe the interfaces between elements of different engineering specialist fields. The logical design should deliver a cost estimation based on the system architecture.

The goal of the Physical Design is to explore the physical effects, to integrate the system components geometrically and to validate the logical design against requirements coming from installation, deformations rules and weight restrictions.

Further on, the investigation priority of the different engineering specialist fields is assigned to either the logical or physical architectural design.

Kinematics and structure design, which both belong to the geometrical design, are separated. Kinematics is assigned to the logical architectural design whereas the structure design is allocated to the physical design. Although the kinematics is described with geometrical data, it defines the motion by logical rules, e.g. due to the order of constraints. The structure design has primarily physical impact on the system, in particular e.g. space allocation and components integration.

Installation is also allocated to the physical architectural design due to the dependence on space allocation. The stress

characteristic of components depends on physical properties.  
 Technical cybernetics is considered to belong to the logical design, because of its relation on system control. It can mainly influence the system architecture, which is considered to be the foundation of the logical design, and should be investigated in the preliminary design phase.

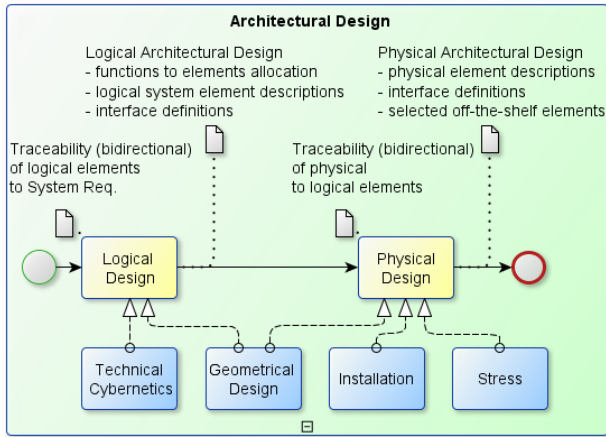

Fig. 4 Stage decomposition and split of engineering domains

Regarding the four disciplines, the following functionality should be achieved with each model of the disciplines:

1. Geometrical Design

- Motion constraints – clarification of tolerances and their impact on functions
- Kinematics – motion simulation based on geo-metrical constraints and plot of inter mediation position results, calculation of static/operation loads
- DMU structure e.g. joint definitions by geo-metrical information – motion simulation based on joint definitions
- 3D parts – parametric and associative models

2. Technical Cybernetics

- Actuation system – system architecture, drive speeds, power consumption
- Control & Monitoring – definition of monitoring and protection logic

3. Installation

- Parts functionality – approval of parts functionality considering specific parameters
- Parts integration – calculation of parts distances

4. Stress

- Interface loads – based on stick models
- Stress analysis – estimation of deformations and weight

Within the logical design frame, the main activity groups should be kinematics design, followed by an integrative architecture design of the drive system and of the control & monitoring system. The physical design includes installation design followed by an integrative structure & stress design

(see Fig. 5). This process layout leads to an integrative consideration between kinematics and control architecture in the preliminary design phase and between installation and structure & stress design in the detailed design phase.

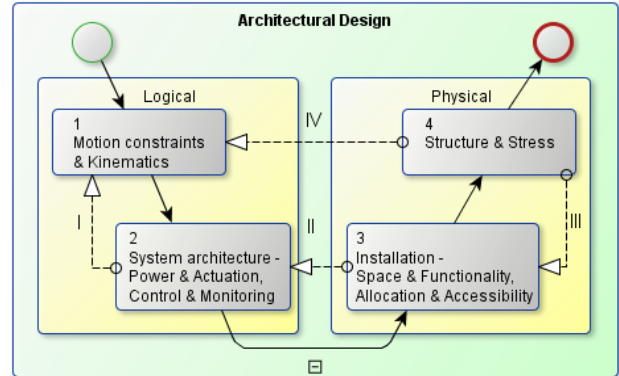

Fig. 5 Multidisciplinary approach in the architectural design

Both domains have an internal concept pre-validation: A plausibility check of the kinematics functionality related to the control system is carried out in the logical design (I in Fig. 5). A validation of the installation related to real structure dimensions and possible bending characteristics is carried out in the physical design (III in Fig. 5). Further on, two validation feedbacks on two different levels should be established between both design domains, logical and physical architectural design (II, IV in Fig. 5). On the functional level, the system architecture should be confirmed (validated) by the installation analysis, which is performed during the installation design, in order to ensure the physical implementation regarding e.g. possible space allocation restrictions (II in Fig. 5). On the geometrical level, the kinematics design should be confirmed (validated) by the structure & stress analysis (IV in Fig. 5) and vice versa.

A. Model-based Workflow

In the next step the described approach shall be implemented in a model-based workflow. This process is shown in Fig. 6 with the four main design tasks already described according to Fig. 4 and Fig. 5.

Before starting a kinematics design, the motion constraints should be analyzed and a sensitivity analysis should be performed in order to estimate the motion constraint tolerances (Fig. 6, I). The motion constraints consider positions and orientations of mechanism parts as well as motion speeds. The kinematics design should be followed by an actuation system design. As soon as kinematics and drive chain concepts have been found, these concepts should be integrated and tested in the context of the control & monitoring architecture. After successful assessment, the kinematics design should be continued and refined (Fig. 6, II) in order to carry out the 3D kinematics motion validation and before proceeding to structural design and installation design. After analysis of the control & monitoring concepts, the components functionality should be proved before generation

of the Digital Mock Up (DMU) skeleton.

Subsequently, the kinematics design should be integrated in the DMU model, elements shall be grouped and the interfaces between the available mechanism parts, e.g. joints definitions, shall be established. Additional parts should be added and described by simplified volume models in order to prepare the parts integration checks during installation analysis. The integration should be validated against the parts functionality (Fig. 6, III).

After the parts integration, the relevant parts which support the mechanisms are defined, along with the definition of the joints. Based on this, the interface loads have to be calculated and stress analysis should be started, which lead to refinement of part dimensions and forms. That leads to a repetition of part integration checks (Fig. 6, IV).

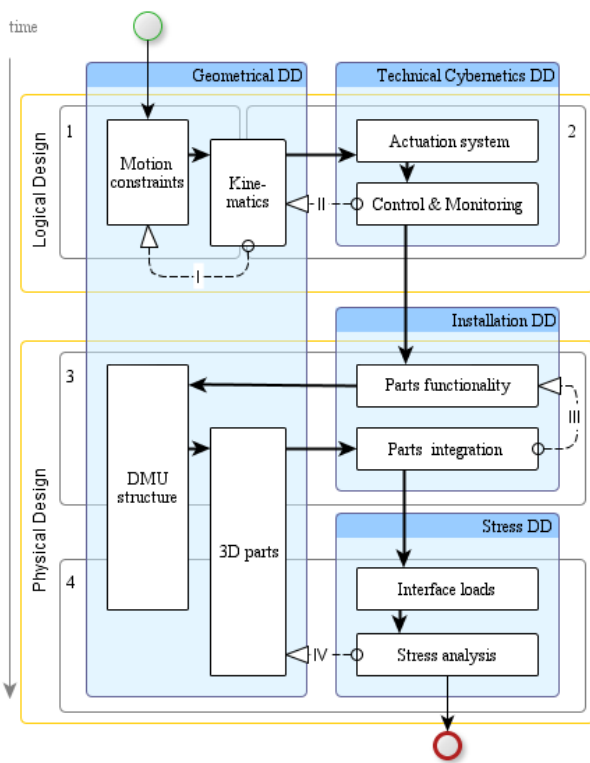

Fig. 6 Concept for a multidisciplinary design process

Four main loops are defined by these four iterations:

1. Motion Constraints – Kinematics – Motion Constraints
2. Kinematics – Actuation system – Control & Monitoring - Kinematics
3. Parts functionality - DMU structure - 3D parts-Parts integration - Parts functionality
4. Parts integration - Interface loads - Stress analysis - 3D parts - Parts integration

#### B. Workflow Implementation – Modeling Tools

Goal of the process implementation is to support fast design iterations and smooth transitions between the design phases and the development stages. The approach for new modeling and implementation techniques is addressed in this section. To

support the continuous design process, different engineering tools can be integrated. Models are assigned to the activity groups as follows:

Motion constraints and motion mechanism kinematic models are assigned to the first process step, the kinematics design.

The kinematics design optimization model, the drive system model and the control and monitoring model are assigned to the second process step, the system architecture design.

The system components functionality model, a Digital Mock Up structure model, initial part models and the parts integration model are assigned to the third process step, the installation design.

Stick models and stress models are assigned to the fourth step, the 3D structure & stress design.

The geometrical design definition is performed using a tool for parametric associative 3D modeling like Catia V5 (see Fig. 7). An interface between 3D kinematics models (CATPart) and DMU models (CATProduct) contributes to efficient assembly structure definition and is a foundation for further structure models and 3D kinematics validation. The process makes use of the available bidirectional interface between SimXpert and Catia.

The technical cybernetics design can be performed using a tool like Matlab&Simulink, currently used for validation of functional specifications of control & monitoring functions. As a powerful tool for optimization tasks, the optimization of the kinematics can be done in Simulink. Physical systems can be modeled using Simscape, which enables a closed loop for kinematics and actuation system optimization within the same simulation environment. If the transmission system is simulated in some other tool like Dymola or SimXpert, a co-simulation to Simulink should be established in order to couple the inertia characteristics of the mechanical systems with the control & monitoring system behavior.

Installation analysis in the context of the process can be performed using SimXpert because of its open model formats and native integration in the CAD tool Catia. Considering the interfaces to Catia, assembly structures and 3D parts can be updated without need for new model import. Changes which have been made in SimXpert can be saved in native Catia formats. For the same integration reasons, stress analysis can be performed also using SimXpert.

A Digital Mock-Up structure which includes parts assembly considering the kinematics or some PDM structure can be used as a backbone for the following installation design and later on also for the structure design, supported by typical coupling between PDM and CAD tools. A Digital Mock Up is widely spread, since modern CAD tools allow switching between workbenches for geometrical definition and different types of analysis.

The automation of the new interface AB (see Fig. 7) enables an automated integration of kinematics models with transmission models. This integration allows for an advanced calculation of operating as well as failure loads in the transmission. By automation of interface BC, a calculation of

interface loads using one or more flexible models of relevant parts can be automated.

An interface from state D to state C is used in order to automate the generation of flexible multi body simulations. After the 3D part design is accomplished in Catia, the use of modal neutral files previously created with Patran®, a flexible multi body simulation is performed in Adams. Models for the state C can be generated based also on templates, including a model description in Python format, as offered by the SimXpert API.

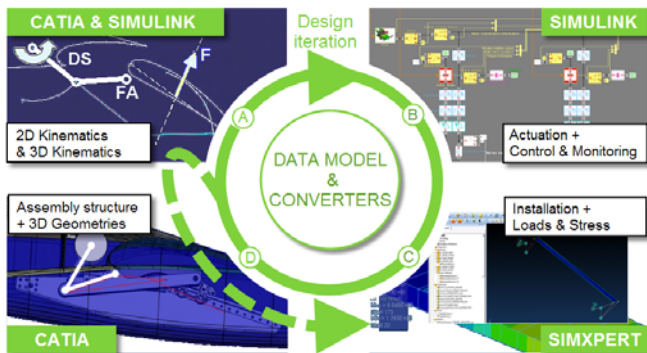

Fig. 7 Example for a multidisciplinary model-based tool chain

The new process follows a clockwise iteration direction, especially in the preliminary design phase – an ABCD states sequence. Changes of distances between kinematics joints as a result of new part strength requirements originating from advanced calculations of interface loads and the following stress analysis may necessitate an adjustment of the kinematics design. In this case, an iteration between the states C, D and A can be necessary (see dotted line) leading to an alternative steps sequence ABCDADC. The state of the art design process follows an anti-clockwise iteration (see Fig. 7) – an ADCB states sequence.

Considering the automated generation of DMU assembly, the process can also use an automated model conversion between state A and D. This includes the automated generation of the assembly structure and the DMU kinematics specifications based on extended 3D kinematics model as input.

These tool interfaces enable automation along the whole iteration circle in both directions - clockwise and anti-clockwise. This possibility for bidirectional tool iterations enables a flexible design process. According to the proposed process, the generation of installation models can be supported by the interfaces AD and DC as well as by AB and BC.

Especially in case of frequent changing of pivot points, there is a need for an automatic data transfer tool from Catia to tools for multi body simulation, installation, load calculations and initial space allocations. The bidirectional interface between A and B can be supported by PrEMISE[4], using a central data model and Eclipse based import and export functionality [4]. Additionally, this interface can be

implemented by using Matlab functions for automated generation of Simulink models as well as Visual Basic scripts for generation of preliminary installation models in Catia.

The preliminary as well as the detailed design should follow a clockwise iteration direction based on a common data model (e.g. PrEMISE), which is updated in the iteration cycles. These methodical iteration cycles guarantee the quality and the consistency of the models of the involved disciplines and aid the collaboration. This is enabled by automated interfaces between the states ABCD.

As a result of the proposed concept, iterations between kinematics, structure design and stress analysis are enhanced by continuous modeling and simulation.

#### IV. APPLICATION DEMONSTRATION

Current developments of High Lift Systems (HLS) for future civil aircraft show a tendency of integration of additional functionality compared to conventional systems [2]. Planned enhanced functions are e.g. adjustment of the center of lift and lateral compensation of undesired roll movement [2]. Possible additional functions in the future could be reached by using multifunctional control surfaces which provide classical functionalities of primary and secondary flight control. A challenge for these multifunctional control devices is the increasing solution space of possible high lift configurations with a higher degree of freedom. As a consequence, more iteration is needed to find a global optimum and a compromise between involved disciplines without negative impact on development time [3]. To be able to define and assess new high lift systems for future aircraft concepts with enhanced functionality, a process as well as tools for the integration of involved disciplines are necessary.

A High Lift System of modern transport aircraft is defined in a multi-disciplinary process which requires compromises between different design criteria driven by requirements, e.g. safety, costs, weight and aerodynamic performance [8]. Hence, the high lift system design is characterized by iterations between involved disciplines like aerodynamics, kinematics, actuation, control & monitoring, structure design, and stress and can be representative for complex mechatronic systems design. Different models are needed to be able to define and assess the system with regard to functional and non-functional requirements[12].

In the context of these disciplines, the process should ensure the achievement of following system qualities:

1. Exact achievement of predefined motion sequences or motion constraints
2. Compliance to safety standards, involving exhaustive consideration of redundancy mechanisms, failure conditions and appropriate control & monitoring concepts
3. Minimization of loads for actuation (operating loads) and structure components (interface loads)
4. Intelligent installation – the functional component arrangement should deliver appropriate component accessibility and comply to supportability and

maintainability concepts

In the context of weight, one of the main design drivers in aerospace industry, and for other advanced analysis in the logical architectural design, an integration of the kinematics

model, the control and monitoring model and the actuation drive chain model is to be established (Fig. 8, Integrate A).

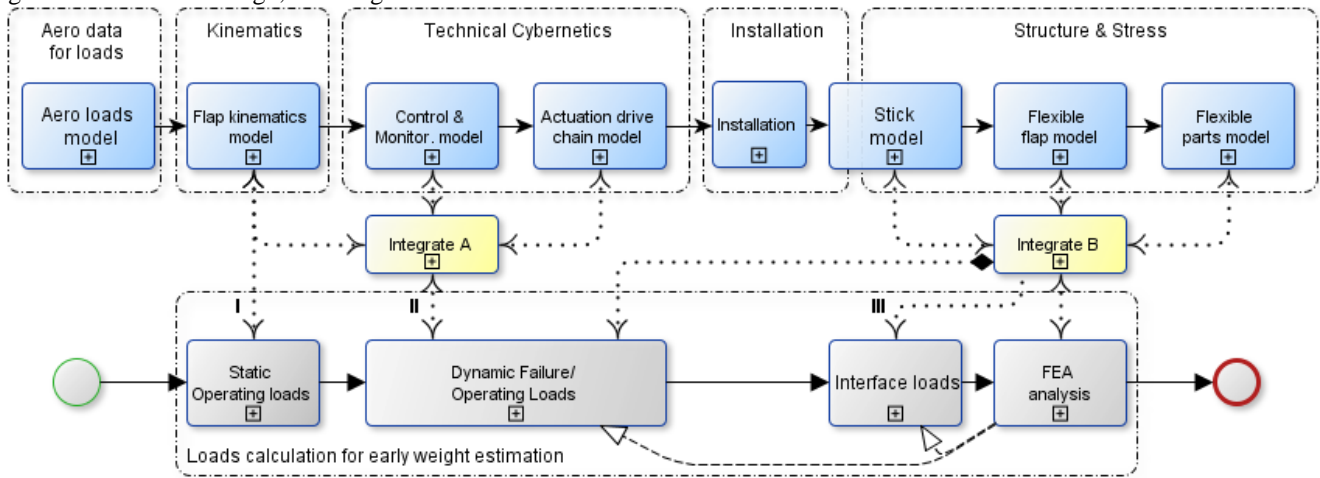

Fig. 8 Example for multidisciplinary loads calculation sequence

For further analysis in the physical architectural design, stick models, flexible flap and other parts models have to be integrated (Integrate B).

The load calculation should be performed in three main steps

1. Calculation of static loads
2. Calculation of dynamic loads
3. Calculation of interface loads

For an early weight estimation, the static operating loads should be calculated based on the kinematics models with constant input coming from the aerodynamic loads model (Fig. 8, I).

Iterations between the kinematics and actuation design (see Fig. 6) as well as the early load calculation for the purpose of early reliable weight estimation shall be supported by an integration of the flap mechanism (kinematics) and the drive and control system (actuation model), including transmission, power control unit and control and monitoring behavior (see Fig. 8, II). This integration enables simulations of transmission ruptures and in the following measurement and analysis of parameters which have to be harmonized e. g. interface loads and sensor signals for failure detection.

For flap twist and skew analysis, the system reaction times and loads from the second load calculation step in combination with flexible part models serve as input for the advanced calculation of interface loads (Fig. 8, III). This step is followed by an optimization of stress characteristics during the FEA analysis. This analysis is important for the validation especially of the safety concept due to restrictions on e.g. acceptable flap twist or skew.

Interfaces of the installation model to flexible MBS models and FEA stress models support the complete stress study (Fig. 6, IV). This enables the evaluation of interface loads, resulting in recommendations about the DMU assembly structure

and/or parts stiffness, e. g. need to change joint positions and/or flap stiffness. Another benefit of the installation model is that, with the definition of the 3D kinematic joints, multi body simulations can be performed using only stiffness models for relevant parts like high lift panels (flaps) and track beams. Third benefit is that these installation models could be continuously, and potentially automatically, transformed in structure assembly models for further detailed design in a CAD environment (Fig. 6, Step no. 3). The part design should be based on structured parameters, e. g. dimension dependencies, and is optimized at the end of the process (Fig. 6, Step no. 4) which reduces structure design iterations.

The 3D kinematics design can be partially automated based on captured expert knowledge and, later on, optimized for load reduction, considering both, operating and failure conditions. The load reduction strongly depends on the safety concept and the actuation & control design and should be analyzed in an environment for multi body simulation and kinematics analysis.

Since loads calculation has a major role in the aerospace industry, the implication of the proposed process will be shortly introduced in the context of model-based design. According to the process sequence, first static operation loads are calculated. This is an initial criterion for the quality of the kinematics design. However, these loads are not relevant for the interface loads which affect the required stiffness of structure parts, but they can be used for actuator analysis and in the context of high lift systems for analysis of torque limiters for protection of thin transmission shafts. As proposed, the next load calculation step integrates the drive system and the control & monitoring system, which can be done e.g. in Simulink using Simscape and SimMechanics. Dynamic operating loads can be calculated considering drive friction, torsional stiffness of the drive system shafts, control

of the power drive unit, etc.

For the calculation of dynamic failure loads, the integration of stiffness models of relevant parts is necessary. This can be done e.g. in Simulink by simplified bending or torsional stiffness models, for which springs and dampers can be used. Deformations can be calculation based on FEA methods using more powerful tools for flexible multi body simulations like Adams or SimXpert.

In the preliminary design phase, the first flexible multi body simulation is performed using only a flexible flap in order to calculate the preliminary interface loads for parts of interest regarding failure cases like flap skew and flap twist. Alternatively and only for flap skew, the interface loads can be calculated even without flexible multi body simulation tools integrating FEA models by using torsion stiffness coefficients. Since an integrated model of the transmission system and the control & monitoring system is available in Simulink, a co-simulation between Simulink and SimXpert is established for advanced studies e.g. on flap skew and flap twist. The flexible multi body simulation is used in the context of validation of control and monitoring concepts. An example from the high lift system domain are the interactions between the stress design of the control surfaces affecting their stiffness and thus torsion flexibility and the control system affecting the system response times and thus dynamic (failure) loads in the context of safety requirements for minimal flap torsion. Besides, fail safe concepts, structure- and system components are mainly influenced by operating and limit loads, which affect weight and cost. The calculation of interface loads considers the interactions between kinematics, actuation system in particular the control & monitoring system and the stress characteristics.

## V. SUMMARY AND OUTLOOK

The use of iterative processes is an important approach for progressive adding value and refinement of process outputs. The interaction between successive verification actions and integration actions can incrementally build confidence in the conformance of the product. Iteration is according to Fig. 3 not only appropriate but also expected; however, the added value depends on the kind of iterations. A process or set of processes, i.e. interactions between the involved disciplines, is currently still missing in the engineering standards.

Probably due to mechatronics systems complexity, nowadays a detailed process specification is not established in the context of different engineering disciplines regarding their interaction and iterations. As a result, there is still a lack of multidisciplinary collaboration caused by obsolete processes belonging to different domains like mechanical engineering, control engineering, electronic engineering and software engineering. In particular, process iterations, which are not specified in VDI 2206, are often not efficient, since interdependencies of different design disciplines as well as interactions between preliminary and detailed design stages are not considered sufficiently. Following, multi objective

optimization strategies for the system under consideration cannot easily be explored.

The presented model-based process is based on a modularization of methods and model based tasks. The utilization and integration of multidisciplinary models is presented and a reasonable integration of models and process sequences for the addressed disciplines is proposed. The analysis of more functional system concepts is supported since functional architecture design is explored more extensively in the early design stage. Design risk, resulting from sub-optimal solutions, is minimized by knowledge of inter-dependencies of engineering domains. In the context of process automation, a brief description of tool interfaces is provided, focusing on effective and seamless data flow between kinematics, cybernetics, installation and structure design. The automation and seamless data flow is a foundation for the design of future multifunctional (flight) control systems due to the tremendous growing solution domain.

An example of HLS design was introduced as a use case for the applicability of the proposed process. Major findings of the comparison of the process with a constructed process model based on state of the art approach are the reduction of costly iterations and improvement of the continuous modeling concepts. Time savings and design of complex mechatronic multi body systems are possible.

The process assessment will be performed in combination with an improved tool chain after implementation of additional interfaces which are currently under development. The tool implementation for definition and assessment of new high lift system concepts is examined at DLR. Use cases currently worked on are from the field of multifunctional moveables and will be supported by the defined process and tools.

## REFERENCES

- [1] A.Morris, MOB: A European Distributed Multi-Disciplinary Design and Optimization Project, Proceedings of 9th AIAA Symposium on Multidisciplinary Analysis and Optimization, Atlanta 2002.
- [2] C.Lulla, Functional Flexibility of the A350XWB High Lift System, DGLR Conference, Bremen 2011.
- [3] D.P.Raymer, Enhancing aircraft conceptual design using multidisciplinary optimization, Doctoral Thesis, ISBN 91-7283-259-2, Royal Institute of Technology, Stockholm 2002.
- [4] H.Schumann, P.Zamov, S.Escher, Model-Based Design and Tool Data Exchange in Aerospace: A Case Study, CEAS Aeronautical Journal, Volume 2, Issue 1-4, Springer, 2011.
- [5] C.Haskins, Systems Engineering Handbook: A Guide for System Life Cycle Processes and Activities, Version 3.2, INCOSE, San Diego, 2010.
- [6] IEEE, Systems and software engineering - System life cycle processes, ISO/IEC 15288, IEEE Std 15288-2008, Piscataway 2008.
- [7] L.Andréani, M.Kirsch, Standard- and Knowledge-Based Kinematic Design in the early Stages of Product Development, ProSTEP iViP Symposium, Berlin 2008.
- [8] P.K.C.Rudolph, D.Kinney, C.P.van Dam, S.G.Shaw, J.C.Vander Kam, R.R.Brodeur, Aero-Mechanical Design Methodology for Subsonic Civil Transport High-Lift Systems, RTO AVT Symposium on Aerodynamic Design and Optimisation of Flight Vehicles in a Concurrent Multi-Disciplinary Environment, Ottawa 1999.
- [9] S.Friedenthal, A.Moore, R.Steiner, A Practical Guide to SysML - The Systems Modeling Language, ISBN 978-0-12-385206-9, Elsevier Science & Technology, 2012.



- [10] P.Homs, Value Improvement through a Virtual Aeronautical Collaborative Enterprise (VIVACE), Final technical achievements, 2007, [http://www.vivaceproject.com/technical\\_leaflet\\_final.pdf](http://www.vivaceproject.com/technical_leaflet_final.pdf)
- [11] VDI, Design methodology for mechatronic systems, VDI 2206, Düsseldorf 2004.
- [12] E. Moerland, T. Zill, B. Nagel, H. Spangenberg, H. Schumann, P.Zamov, Application of a Distributed MDAO Framework to the Design of a Short- to Medium-Range Aircraft, DLRK, Berlin 2012, urn:nbn:de:101:1-201211303909.