

# Simultaneous Tuning of Static Var Compensator and Power System Stabilizer Employing Real-Coded Genetic Algorithm

S. Panda, N. P. Patidar and R. Singh

**Abstract**—Power system stability enhancement by simultaneous tuning of a Power System Stabilizer (PSS) and a Static Var Compensator (SVC)-based controller is thoroughly investigated in this paper. The coordination among the proposed damping stabilizers and the SVC internal voltage regulators has also been taken into consideration. The design problem is formulated as an optimization problem with a time-domain simulation-based objective function and Real-Coded Genetic Algorithm (RCGA) is employed to search for optimal controller parameters. The proposed stabilizers are tested on a weakly connected power system with different disturbances and loading conditions. The nonlinear simulation results are presented to show the effectiveness and robustness of the proposed control schemes over a wide range of loading conditions and disturbances. Further, the proposed design approach is found to be robust and improves stability effectively even under small disturbance and unbalanced fault conditions.

**Keywords**—Real-Coded Genetic Algorithm (RCGA), Static Var Compensator (SVC), Power System Stabilizer (PSS), Low Frequency Oscillations, Power System Stability.

## I. INTRODUCTION

LOW frequency oscillations are observed when large power systems are interconnected by relatively weak tie lines. These oscillations may sustain and grow to cause system separation if no adequate damping is available [1]. Power System Stabilizers (PSS) are now routinely used in the industry to damp out power system oscillations [2-4]. However, during some operating conditions, this device may not produce adequate damping, and other effective alternatives are needed in addition to PSS. With the advent of Flexible AC Transmission System (FACTS) technology, shunt FACTS devices play an important role in controlling the reactive power flow in the power network and hence the system voltage fluctuations and stability [5-7]. Static Var Compensator (SVC) is member of FACTS family that is connected in shunt with the system [8, 9]. Even though the

primary purpose of SVC is to support bus voltage by injecting (or absorbing) reactive power, it is also capable of improving the power system stability [10]. When a SVC is present in a power system to support the bus voltage, a supplementary damping controller could be designed to modulate the SVC bus voltage in order to improve damping of system oscillations [11, 12].

The interaction among PSS and SVC-based controller may enhance or degrade the damping of certain modes of rotor's oscillating modes. To improve overall system performance, many researches were made on the coordination between PSSs and FACTS power oscillation damping controllers [13-15]. Also, the controllers should provide some degree of robustness to the variations loading conditions, and configurations as the machine parameters change with operating conditions. A set of controller parameters which stabilise the system under a certain operating condition may no longer yield satisfactory results when there is a drastic change in power system operating conditions and configurations [16, 17].

The problem of PSS and FACTS controllers parameter tuning is a complex exercise as uncoordinated local control of FACTS devices and PSS may cause destabilising interactions. A number of conventional techniques have been reported in the literature pertaining to design problems of conventional power system stabilizers namely: the pole placement technique [18], phase compensation/root locus technique (Larsen and Swann [19], residue compensation [20], and also the modern control theory. Unfortunately, the conventional techniques are time consuming and require heavy computation burden and slow convergence. In addition, the search process is susceptible to be trapped in local minima and the solution obtained may not be optimal. The evolutionary methods constitute an approach to search for the optimum solutions via some form of directed random search process. A relevant characteristic of the evolutionary methods is that they search for solutions without previous problem knowledge. Recently, Genetic Algorithm (GA) appeared as a promising evolutionary technique for handling the optimization problems [21]. GA has been popular in academia and the industry mainly because of its intuitiveness, ease of implementation, and the ability to effectively solve highly nonlinear, mixed integer optimisation problems that are typical of complex engineering systems. In view of the above, this paper proposes to use Real-coded genetic algorithm (RCGA) optimization technique for the

S. Panda is working as Professor in the Department of Electrical and Electronics Engineering, National Institute of Science and Technology, Berhampur, Orissa, INDIA. (e-mail: panda\_sidhartha@rediffmail.com).

N.P.patidar is working as a Senior Lecturer in Electrical Engineering Department, MANIT, Bhopal, India. (e-mail: nppatidar@yahoo.com)

R. Singh is a Lecturer in the Department of Electrical Engineering, MANIT, Bhopal, India (e-mail: rishikhsingh@yahoo.com)

simultaneous tuning of PSS and SVC-based controller. To improve the interactions between PSS and SVC-based controller, RCGA based optimal tuning approach is employed to simultaneous and coordinately design the proposed damping controllers.

The reminder of the paper is organized in five major sections. An overview of SVC and its control system is presented in Section II. The structures of the PSS and SVC-based controller and the objective function are described in Section III. In Section IV a brief introduction about real coded genetic algorithm is provided. Results are given and discussed in Section V.

## II. OVERVIEW OF SVC AND ITS CONTROL SYSTEM

SVC is basically a shunt connected Static Var Generator whose output is adjusted to exchange capacitive or inductive current so as to maintain or control specific power system variables. Fig. 1 shows the single-line diagram of a SVC and a simplified block diagram of its control system.

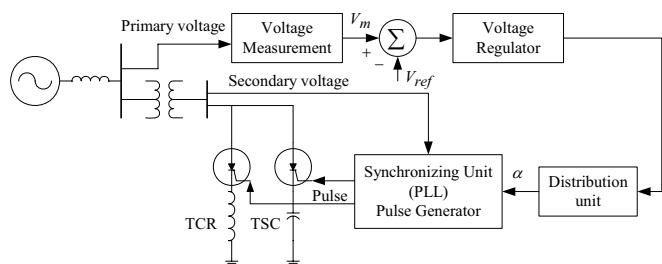

Fig. 1 Single-line diagram of a Static Var Compensator and its control system

The control system consists of [22]:

- A measurement system measuring the positive-sequence voltage to be controlled.
- A voltage regulator that uses the voltage error (difference between the measured voltage  $V_m$  and the reference voltage ( $V_{ref}$ )) to determine the SVC susceptance needed to keep the system voltage constant.
- A distribution unit that determines the Thyristor Switched Capacitors (TSC) and eventually Thyristor Switched Reactors (TSR) that must be switched in and out, and computes the firing angle  $\alpha$  of TCRs.
- A synchronizing system using a phase-locked loop (PLL) synchronized on the secondary voltages and a pulse generator that send appropriate pulses to the thyristors.

## III. PROBLEM FORMULATION

### A. Structure of PSS and SVC-based Controller

The commonly used lead-lag structure is chosen in this study as SVC-based controller as shown in Fig. 2. Fig. 3

shows the structure of the power system stabilizer used in the present study. The input signal to both the controller is the speed deviation  $\Delta\omega$ . Each structure consists of: a gain block; a signal washout block and two-stage phase compensation block. The phase compensation block provides the appropriate phase-lead characteristics to compensate for the phase lag between input and the output signals. The signal washout block serves as a high-pass filter which allows signals associated with oscillations in input signal to pass unchanged. Without it steady changes in input would modify the output.

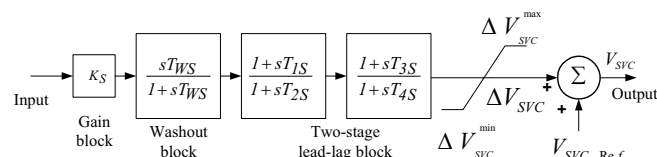

Fig. 2 Structure of the SVC-based controller

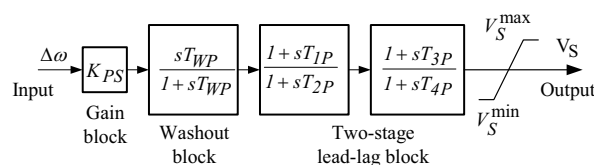

Fig. 3 Structure of the power system stabilizer

### B. Problem Formulation

In lead-lag structured controllers from the viewpoint of the washout function the value of washout time constant is not critical and may be in the range 1 to 20 seconds [1] and generally the washout time constant is prespecified. In the present study, washout time constant of  $T_{WS} = T_{WP} = 10$  s is used. The controller gains  $K_S$  and  $K_{PS}$ ; and the time constants  $T_{1S}$ ,  $T_{2S}$ ,  $T_{3S}$  and  $T_{4S}$ ,  $T_{1P}$ ,  $T_{2P}$ ,  $T_{3P}$  and  $T_{4P}$  are to be determined. For the internal voltage regulator of the SVC, the PI structure is used. The parameters of the PI controller are:  $K_{PVR}$ , and  $K_{IVR}$ . These controllers are designed in coordination with the SVC-based controller and PSS.

It is worth mentioning that the proposed controllers are designed to minimize the power system oscillations after a large disturbance so as to improve the power system stability. In the present study, an integral time absolute error of the speed deviations is taken as the objective function. The objective function is expressed as:

$$J = \int_{t=0}^{t=t_{sim}} |\Delta\omega| \cdot t \cdot dt \quad (1)$$

Where,  $\Delta\omega$  is the speed deviation and  $t_{sim}$  is the time range of the simulation.

For objective function calculation, the time-domain simulation of the power system model is carried out for the simulation period. It is aimed to minimize this objective function in order to improve the system response in terms of the settling time and overshoots.

#### IV. OVERVIEW OF GENETIC ALGORITHM (GA)

Genetic algorithm (GA) has been used to solve difficult engineering problems that are complex and difficult to solve by conventional optimization methods. GA maintains and manipulates a population of solutions and implements a survival of the fittest strategy in their search for better solutions. The fittest individuals of any population tend to reproduce and survive to the next generation thus improving successive generations. The inferior individuals can also survive and reproduce.

Implementation of GA requires the determination of six fundamental issues: chromosome representation, selection function, the genetic operators, initialization, termination and evaluation function. Brief descriptions about these issues are provided in the following sections.

##### A. Chromosome representation

Chromosome representation scheme determines how the problem is structured in the GA and also determines the genetic operators that are used. Each individual or chromosome is made up of a sequence of genes. Various types of representations of an individual or chromosome are: binary digits, floating point numbers, integers, real values, matrices, etc. Generally natural representations are more efficient and produce better solutions. Real-coded representation is more efficient in terms of CPU time and offers higher precision with more consistent results.

##### B. Selection function

To produce successive generations, selection of individuals plays a very significant role in a genetic algorithm. The selection function determines which of the individuals will survive and move on to the next generation. A probabilistic selection is performed based upon the individual's fitness such that the superior individuals have more chance of being selected. There are several schemes for the selection process: roulette wheel selection and its extensions, scaling techniques, tournament, normal geometric, elitist models and ranking methods.

The selection approach assigns a probability of selection  $P_i$  to each individuals based on its fitness value. In the present study, normalized geometric selection function has been used. In normalized geometric ranking, the probability of selecting an individual  $P_i$  is defined as:

$$P_i = q^i (1-q)^{r-1} \quad (2)$$

$$q^i = \frac{q}{1-(1-q)^P} \quad (3)$$

where,

$q$  = probability of selecting the best individual

$r$  = rank of the individual (with best equals 1)

$P$  = population size

##### C. Genetic operators

The basic search mechanism of the GA is provided by the genetic operators. There are two basic types of operators: crossover and mutation. These operators are used to produce new solutions based on existing solutions in the population. Crossover takes two individuals to be parents and produces two new individuals while mutation alters one individual to produce a single new solution. The following genetic operators are usually employed: simple crossover, arithmetic crossover and heuristic crossover as crossover operator and uniform mutation, non-uniform mutation, multi-non-uniform mutation, boundary mutation as mutation operator. Arithmetic crossover and non-uniform mutation are employed in the present study as genetic operators. Crossover generates a random number  $r$  from a uniform distribution from 1 to  $m$  and creates two new individuals by using equations:

$$x_i' = \begin{cases} x_i, & \text{if } i < r \\ y_i & \text{otherwise} \end{cases} \quad (4)$$

$$y_i' = \begin{cases} y_i, & \text{if } i < r \\ x_i & \text{otherwise} \end{cases} \quad (5)$$

Arithmetic crossover produces two complimentary linear combinations of the parents, where  $r = U(0, 1)$ :

$$\bar{X}' = r \bar{X} + (1-r) \bar{Y} \quad (6)$$

$$\bar{Y}' = r \bar{Y} + (1-r) \bar{X} \quad (7)$$

Non-uniform mutation randomly selects one variable  $j$  and sets it equal to a non-uniform random number.

$$x_i' = \begin{cases} x_i + (b_i - x_i) f(G) & \text{if } r_1 < 0.5, \\ x_i + (x_i + a_i) f(G) & \text{if } r_1 \geq 0.5, \\ x_i, & \text{otherwise} \end{cases} \quad (8)$$

where,

$$f(G) = (r_2 (1 - \frac{G}{G_{\max}}))^b \quad (9)$$

$r_1, r_2$  = uniform random nos. between 0 to 1.

$G$  = current generation.

$G_{\max}$  = maximum no. of generations.

$b$  = shape parameter.

##### D. Initialization, termination and evaluation function

An initial population is needed to start the genetic algorithm procedure. The initial population can be randomly generated or can be taken from other methods.

The GA moves from generation to generation until a stopping criterion is met. The stopping criterion could be maximum number of generations, population convergence criteria, lack of improvement in the best solution over a specified number of generations or target value for the objective function.

Evaluation functions or objective functions of many forms can be used in a GA so that the function can map the population into a partially ordered set. The computational flowchart of the GA optimization process employed in the present study is given in Fig. 4.

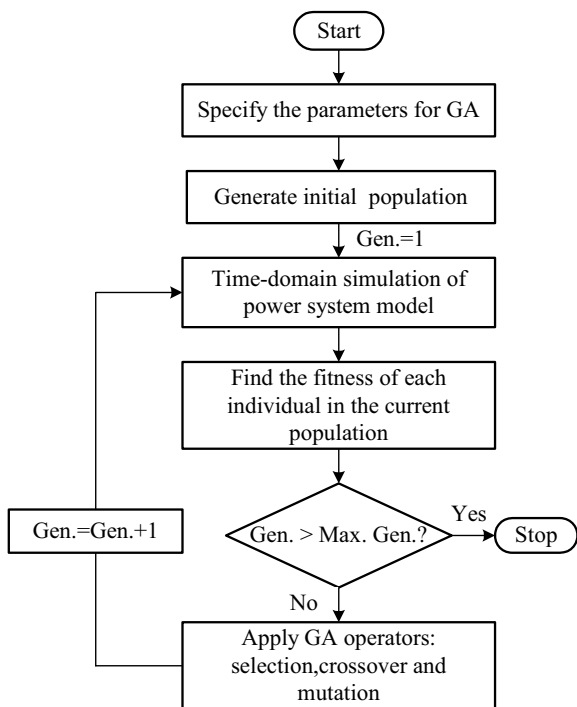

Fig. 4. Flowchart of genetic algorithm

## V. RESULTS AND DISCUSSIONS

The SimPowerSystems (SPS) toolbox is used for all simulations and PSS design. SPS is a MATLAB-based modern design tool that allows scientists and engineers to rapidly and easily build models to simulate power systems using Simulink environment. The SPS's main library, *powerlib*, contains models of typical power equipment such as machines, governors, excitation systems, transformers, and transmission lines. The library also contains the Powergui block that opens a graphical user interface for the steady-state analysis of electrical circuits. The Load Flow and Machine Initialization option of the Powergui block performs the load flow and the machines initialization [22].

In power system stability study, the fast oscillation modes resulting from the interaction of linear R, L, C elements and distributed parameter lines are of no interest. These oscillation modes, which are usually located above the fundamental frequency of 50 Hz or 60 Hz, do not interfere with the slow machine modes and regulator time constants. The phasor

solution method is used here where these fast modes are ignored by replacing the network's differential equations by a set of algebraic equations. The state-space model of the network is replaced by a transfer function evaluated at the fundamental frequency and relating inputs (current injected by machines into the network) and outputs (voltages at machine terminals). The phasor solution method uses a reduced state-space model consisting of slow states of machines, turbines, and regulators, thus dramatically reducing the required simulation time. In view of the above, the phasor solution method is used in the present study.

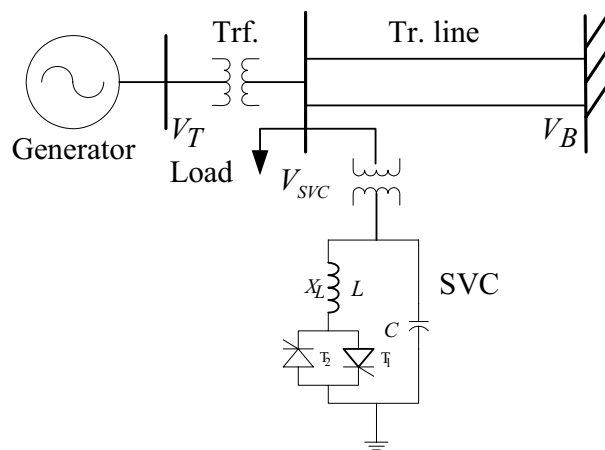

Fig. 5. Single-machine infinite-bus power system with SVC

### A. Application of RCGA

In order to coordinately design PSS and SVC-based controller, as well as to assess their performance, a single-machine infinite-bus power system with SVC depicted in Fig. 5 is considered at the first instance. The model of example power system shown in Fig. 5 is developed using SimPowerSystems blockset. The system consists of a of 500 MVA, 13.8 kV, 60 Hz hydraulic generating unit, connected to an infinite bus through a 300 km long double-circuit transmission, 3-phase 13.8/500 kV step-up transformer and a 100 MVA STATCOM. The generator is equipped with hydraulic turbine and governor (HTG), excitation system and a power system stabilizer. The HTG represents a nonlinear hydraulic turbine model, a PID governor system, and a servomotor. The excitation system consists of a voltage regulator and DC exciter, without the exciter's saturation function. All the relevant parameters are given in Appendix.

The objective function is evaluated for each individual by simulating the example power system, considering a severe disturbance. For objective function calculation, a 3-phase short-circuit fault in one of the parallel transmission lines is considered. For the implementation of GA normal geometric selection is employed which is a ranking selection function based on the normalized geometric distribution. Arithmetic crossover takes two parents and performs an interpolation along the line formed by the two parents. Non uniform mutation changes one of the parameters of the parent based on a non-uniform probability distribution. This Gaussian

distribution starts wide, and narrows to a point distribution as the current generation approaches the maximum generation. The parameters employed for the implementations of RCGA in the present study are given in Table I. Based on the previous experience these parameters have been chosen.

Simulations were conducted on a Pentium 4, 3 GHz, 504 MB RAM computer, in the MATLAB 7.0.1 environment and the optimisation process is repeated 20 times. As three-phase non-linear models of power system components are used in the present study, realization of RCGA optimization process consumes on an average 5000 sec of CPU time. The best final solutions obtained in the 20 runs are given below.

TABLE I PARAMETERS USED IN GENETIC ALGORITHM

Parameter	Value/Type
Maximum generations	100
Population size	50
Type of selection	Normal geometric [0 0.08]
Type of crossover	Arithmetic [2]
Type of mutation	Nonuniform [2 100 3]
Termination method	Maximum generation

For SVC-based controller:

$$K_S=37.6583, T_{1S}=0.3739, T_{2S}=0.2471, T_{3S}=0.1376, T_{4S}=0.2898 \text{ s}$$

For SVC voltage regulator:

$$K_{P_{VR}}=2.9959, K_{I_{VR}}=682.4987$$

$$K_{P_{ICR}}=0.2381, K_{I_{ICR}}=11.4192, K_{F_{ICR}}=0.1578$$

For power system stabilizer:

$$K_{PS}=6.7020, T_{1P}=0.3056, T_{2P}=0.32, T_{3P}=0.3542, T_{4P}=0.314 \text{ s}$$

### B. Simulation Results for SMIB Power System

To assess the effectiveness and robustness of the proposed controller given in Table II are considered. Simulation studies are carried out for various fault disturbances and fault clearing sequences. The behavior of the proposed controller under transient conditions is verified by applying various types of disturbances under different operating conditions.

TABLE II LOADING CONDITIONS CONSIDERED

Loading Conditions	P (pu)	$\delta_0$ (deg.)
Nominal	0.8	33.8 <sup>0</sup>
Light	0.5	21.5 <sup>0</sup>
Heavy	1.0	41.5 <sup>0</sup>

In all the Figs., the response without control (no control) is shown with dotted line with legend NC; the response with conventionally designed power system stabilizer [22] is shown with dashed lines with legend CP and the response with proposed RCGA optimized PSS and SVC-based controllers are shown with solid line with legend CC respectively.

Case I: Nominal loading, 3-phase fault disturbance:

The behavior of the proposed controllers is verified at nominal loading condition under severe disturbance. A 5-cycle, 3-phase fault is applied at the infinite-bus terminal at  $t = 1.0$  sec. The original system is restored upon the fault clearance. The system response under this severe disturbance is shown in Figs. 6-9.

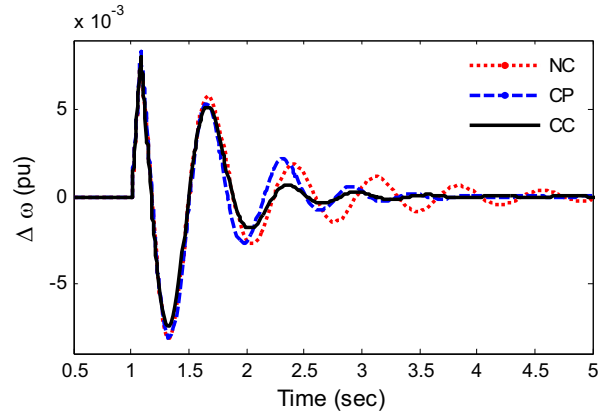

Fig. 6. Speed deviation response for Case-I

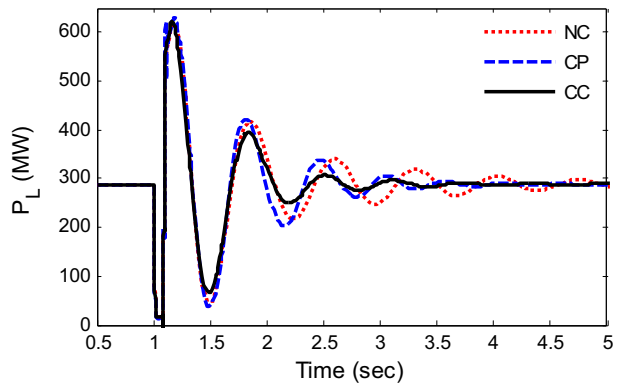

Fig. 7. Tie-line power flow response for Case-I

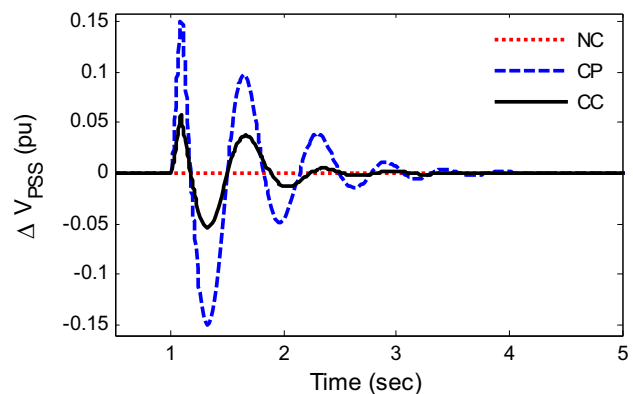

Fig. 8. Stabilising signal of PSS for Case-I

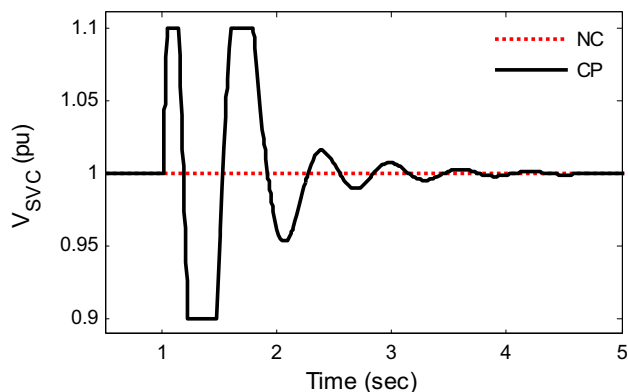

Fig. 9. SVC reference voltage signal for Case-I

It can be observed from Figs.6-9 that with out control the system is highly oscillatory for the above contingency. It is also clear that, coordinately designed PSS and SVC-based controller outperform the CPSS and power system oscillations are quickly damped out.

*Case II: Light loading, 3-phase fault and line outage disturbance:*

To test the robustness of the controller to operating condition and fault clearing sequence, the generator loading is changed to light loading condition and a 5-cycle, 3-phase fault

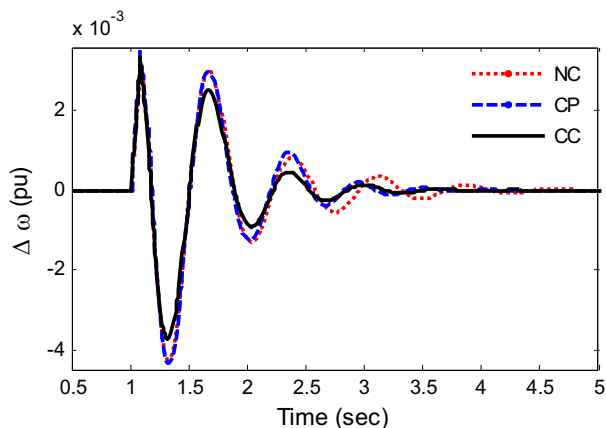

Fig. 10. Speed deviation response for Case-II

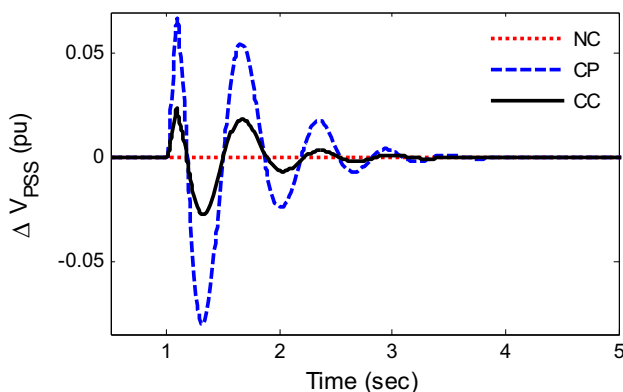

Fig. 11. Stabilising signal of PSS for Case-II

is applied at the middle of the one transmission line at  $t = 1.0$  sec. The fault is cleared by opening of the faulty line and the line is reclosed after 5-cycles. The system responses for the above contingency are shown in Figs. 10-12. It can be seen from Figs. 10-12 that without control, the system is poorly damped for the above contingency. It can also be seen from Figs. 10-12 that with proposed design approach, power system oscillations are quickly damped out and also the response is superior to that with CPSS.

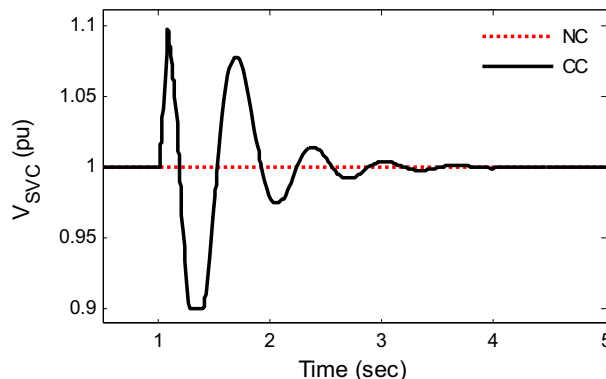

Fig. 12. SVC reference voltage signal for Case-II

*Case III: Heavy loading and line outage disturbance:*

To test the robustness of the controller to operating condition and type of disturbance, the generator loading is changed to heavy loading condition and a line outage disturbance is simulated. Both the transmission lines are tripped at  $t = 1.0$  sec and reclosed after 5-cycles. The original system is restored after the line reclosure. The system response for the above severe disturbance is shown in Figs. 13-15. It can be clearly seen from Figs. 13-15 that for the given operating condition and contingency, the system is highly oscillatory without control. Stability of the system is maintained and power system oscillations are effectively damped with the application of conventional PSS. It can also be seen from Figs. 13-15 that with proposed design approach, power system oscillations are quickly damped out and also the response is superior to that with CPSS.

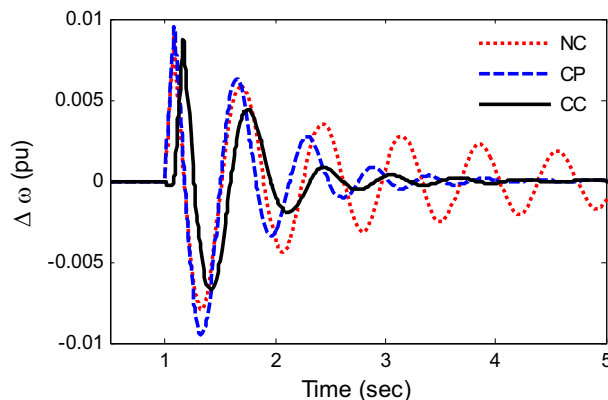

Fig. 13. Speed deviation response for Case-III

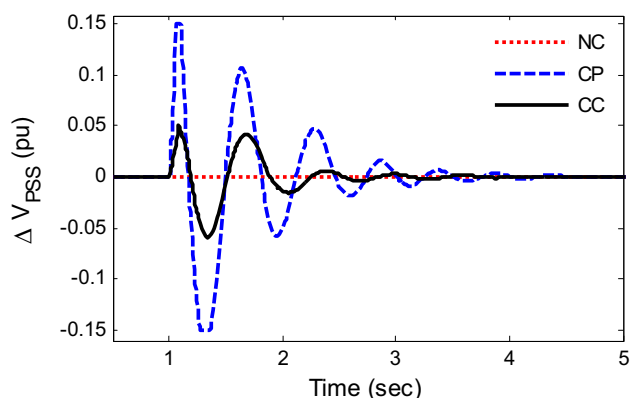

Fig. 14. Stabilising signal of PSS for Case-III

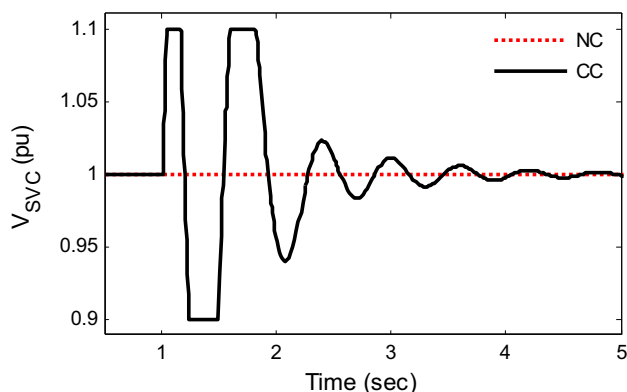

Fig. 15. SVC reference voltage signal for Case-III

*Case IV: Small disturbance:*

The effectiveness of the proposed controllers is also tested under small disturbance. The mechanical power input to the generator is increased by 10% at  $t=1.0$  s. at nominal loading condition. The system speed deviation response for the above contingency is shown in Fig. 16. It can be seen from Fig. 12 that the proposed controllers which are designed under large disturbance work effectively under small disturbance condition also.

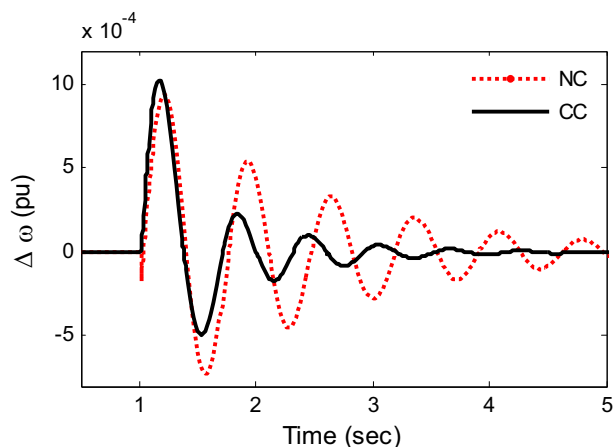

Fig. 16. Speed deviation response for Case-IV

*Case V: Unbalanced fault disturbance:*

The effectiveness of the proposed controller on unbalanced faults is also examined by applying self-clearing type unsymmetrical faults, namely L-L-G and L-G faults, each of 5-cycle duration at the infinite-bus terminal at  $t = 1.0$  sec. The system speed deviation responses for the above contingencies are shown in Fig. 16. The uncontrolled system response for the least-severe single L-G fault is also shown in Fig. 16 with dotted line. It is clear from Fig. 16 that the power-system oscillations are poorly damped in the uncontrolled case, even for the least-severe L-G fault, and the proposed damping controllers effectively stabilizes the power system oscillations under various unbalanced fault conditions.

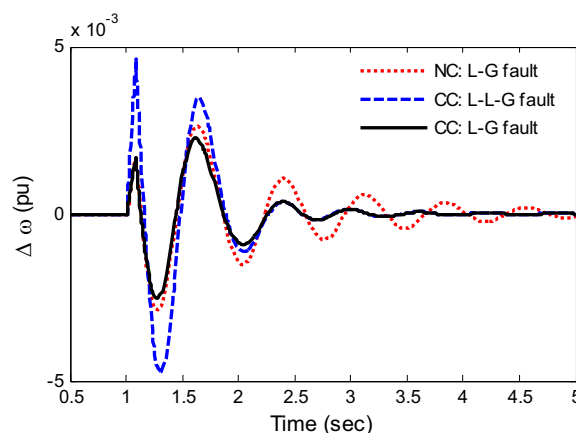

Fig. 17. Speed deviation response for Case-V

VI. CONCLUSION

In this study, real-coded genetic algorithm optimization technique is employed for the simultaneous tuning of a PSS and a SVC-based controller. The coordination among the proposed damping stabilizers and the SVC internal voltage regulator has also been taken into consideration. For the design problem, a non-linear, time-domain simulation-based objective function, to increase the power system stability is used and RCGA optimization technique is employed to optimally tune the parameters of the proposed controllers. The effectiveness of the proposed coordinated design approach in improving the power system stability is demonstrated for variation in loading conditions and under different disturbances and compared with a conventional power system stabilizer. It is observed that the proposed controllers generate suitable variation of the control signals and provide efficient damping to power system oscillations following any disturbance. Further, the proposed design approach is robust and improves stability effectively even under small disturbance and unbalanced fault conditions.

APPENDIX

A complete list of parameters used appears in the default options of SimPowerSystems in the User's Manual [22]. All data are in pu unless specified otherwise.

Generator:  $S_B = 500$  MVA,  $H = 3.7$  s,  $V_B = 13.8$  kV,  $f = 60$  Hz,  $R_s = 2.8544 \text{ e }^{-3}$ ,  $X_d = 1.305$ ,  $X_d' = 0.296$ ,  $X_d'' = 0.252$ ,  $X_q = 0.474$ ,  $X_q' = 0.243$ ,  $X_q'' = 0.18$ ,  $T_d = 1.01$  s,  $T_d' = 0.053$  s,  $T_{qo} = 0.1$  s,  $P_e = 0.8$  pu,  $\delta_0 = 48.48^\circ$

Load at Bus2: 100MW

Transformer: 500 MVA, 13.8/500 kV, 60 Hz,  $R_1 = R_2 = 0.002$ ,  $L_1 = 0$ ,  $L_2 = 0.12$ ,  $D_1/Y_g$  connection,  $R_m = 500$ ,  $L_m = 500$

Transmission line: 3-Ph, 60 Hz, Length = 300 km each,  $R_l = 0.02546 \text{ } \Omega/\text{ km}$ ,  $R_0 = 0.3864 \text{ } \Omega/\text{ km}$ ,  $L_l = 0.9337 \text{ e }^{-3} \text{ H/km}$ ,  $L_0 = 4.1264 \text{ e }^{-3} \text{ H/km}$ ,  $C_l = 12.74 \text{ e }^{-9} \text{ F/km}$ ,  $C_0 = 7.751 \text{ e }^{-9} \text{ F/km}$

Hydraulic turbine and governor:  $K_a = 3.33$ ,  $T_a = 0.07$ ,  $G_{min} = 0.01$ ,  $G_{max} = 0.97518$ ,  $V_{gmin} = -0.1$  pu/s,  $V_{gmax} = 0.1$  pu/s,  $R_p = 0.05$ ,  $K_p = 1.163$ ,  $K_i = 0.105$ ,  $K_d = 0$ ,  $T_d = 0.01$  s,  $\beta = 0$ ,  $T_w = 2.67$  s

Excitation system:  $T_{LP} = 0.02$  s,  $K_a = 200$ ,  $T_a = 0.001$  s,  $K_c = 1$ ,  $T_e = 0$ ,  $T_b = 0$ ,  $T_c = 0$ ,  $K_f = 0.001$ ,  $T_f = 0.1$  s,  $E_{fmin} = 0$ ,  $E_{fmax} = 7$ ,  $K_p = 0$

Conventional power system stabilizer:  $T_S = 15$  ms,  $T_W = 10$  s,  $T_I = 0.05$  s,  $T_2 = 0.02$  s,  $T_3 = 3$  s,  $T_4 = 5.4$  s, Output limits of  $V_S = \pm 0.15$

Static Var Compensator: 500KV,  $\pm 100$  MVAR, Droop=0.03

#### ACKNOWLEDGEMENT

The first author gratefully acknowledges the support and encouragement received from Prof. Sangram Mudali (Director) and Dr. Ajit K. Panda (Dean), National Institute of Science and Technology, Berhampur, Orissa-761008, India.

#### REFERENCES

- [1] P. Kundur, *Power System Stability and Control*. New York: McGraw-Hill, 1994.
- [2] Sidhartha Panda and N.P.Padhy, "Robust power system stabilizer design using particle swarm optimization technique", *International Journal of Electrical Systems Science and Engineering*, Vol. 1, No. 1, pp. 1-8, 2008.
- [3] Sidhartha Panda and C.Ardil, "Robust Coordinated Design of Multiple Power System Stabilizers Using Particle Swarm Optimization Technique", *International Journal of Electrical, System Science and Engineering*, Vol. 1, No. 1, pp. 41-48, 2008.
- [4] Sidhartha Panda and C.Ardil, "Real-Coded Genetic Algorithm for Robust Power System Stabilizer Design", *International Journal of Electrical, Computers and System Engineering*, Vol. 2, No. 1, pp. 6-14, 2008.
- [5] N. G. Hingorani, L. Gyugyi, *Understanding FACTS: Concepts and Technology of Flexible AC Transmission Systems*, IEEE Press, New York, 2000.
- [6] Y. H Song, T. A. Johns, *Flexible AC Transmission Systems (FACTS)*, IEE, London, 2000.
- [7] R. M Mathur, R. K. Verma, *Thyristor-based FACTS Controllers for Electrical Transmission Systems*, IEEE Press, Piscataway, 2002.
- [8] L. Gyugyi, "Reactive power generation and control by thyristor circuits" *IEEE Trans. Industrial Applications*, Vol. IA-15, No.-5, pp.521-532, Sept./Oct. 1979.
- [9] L. Gyugyi, "Power electronics in electric utilities: static var compensators," *IEEE Proceedings*, vol.76, No. 4, pp. 483-494, April 1988.
- [10] T. Hiyama, W. Hubbi and T. H. Ortmeier, "Fuzzy logic control scheme with variable gain for static Var compensator to enhance power system stability" *IEEE Trans. Power Systems*, Vol. 14, No. 1, pp.186-191, Feb. 1999.
- [11] X. Y. Bian, C. Y. Chunga, K. W. Wang and C. T. Tse, "Choice of SVC location/signal and its controller design by probabilistic method", *Electric Power Systems Research*, Vol. 71, No 1, pp. 35-40, Sept. 2004.
- [12] Y. Chang and Z. Xu, "A novel SVC supplementary controller based on wide area signals", *Electric Power System Research*, Electric Power Syst. Res. Vol. 77, pp. 1569-1574, 2007.
- [13] Sidhartha Panda, N. P. Patidar and R.Singh, "Robust coordinated design of excitation and STATCOM-based controller for power system stability improvement", article in press in *International Journal of Innovative Computing and Applications*.
- [14] Sidhartha Panda and N.P.Padhy, "Power System with PSS and FACTS Controller: Modelling, Simulation and Simultaneous Tuning Employing Genetic Algorithm" *International Journal of Electrical, Computer and Systems Engineering*, Vol. 1, No. 1, pp. 9-18, 2007.
- [15] Sidhartha Panda and N.P.Padhy, "Coordinated design of TCSC controller and PSS employing particle swarm optimization technique" *International Journal of Computer and Information Science and Engineering*, Vol. 1, No. 1, pp. 1-9, 2007.
- [16] Sidhartha Panda and N.P.Padhy, "Comparison of Particle Swarm Optimization and Genetic Algorithm for FACTS-based Controller Design", *Applied Soft Computing*. Elsevier, Vol. 8, issue 4, pp. 1418-1427, 2008.
- [17] Sidhartha Panda, N.P.Padhy, R.N.Patel, "Power System Stability Improvement by PSO Optimized SSSC-based Damping Controller", *Electric Power Components & Systems*, Vol. 36, No. 5, pp. 468-490, 2008.
- [18] M. Nambu and Y. Ohsawa, "Development of an advanced power system stabilizer using a strict linearization approach", *IEEE Transactions on Power Systems*, Vol. 11, pp. 813-818, 1996.
- [19] E. V. Larsen and D. A. Swann "Applying Power System Stabilizers Part II: Performance Objectives and Tuning Concepts", *IEEE Transactions on Power Apparatus and Systems*, Vol. 100, pp. 3025-3033, 1981.
- [20] M. E. About-Ela, A. A. Sallam, J. D. McCalley and A. A. Fouad, "Damping controller design for power system oscillations using global signals", *IEEE Transactions on Power Systems*, Vol. 11, pp. 767-773, 1996.
- [21] D. E. Goldberg, *Genetic Algorithms in Search, Optimization and Machine Learning*. Addison-Wesley, 1989.
- [22] SimPowerSystems 4.3 User's Guide, Available: <http://www.mathworks.com/products/simpower/>



**Sidhartha Panda** is a Professor at National Institute of Science and Technology, Berhampur, Orissa, India. He received the Ph.D. degree from Indian Institute of Technology, Roorkee, India in 2008, M.E. degree in Power Systems Engineering in 2001 and B.E. degree in Electrical Engineering in 1991. Earlier he worked as Associate Professor in KIIT University, Bhubaneswar, India & VITAM College of Engineering, Andhra Pradesh, India and Lecturer in the Department of Electrical Engineering, SMIT, Orissa, India. His areas of research include power system transient stability, power system dynamic stability, FACTS, optimisation techniques, distributed generation and wind energy.

**Narayana Prasad Patidar** obtained his PhD from Indian Institute of Technology, Roorkee, in 2008. Presently, he is working as a Senior Lecturer in Electrical Engineering Department, MANIT, Bhopal, India. His research interests are voltage stability, security analysis, power system stability and intelligent techniques.

**Rishi Singh** received his MTech in Power System Engineering from NIT, Bhopal. At present, he is a Lecturer in the Department of Electrical Engineering, MANIT, Bhopal, Madhya Pradesh, India and working towards his PhD. His research interests are FACTS, power system stability, optimisation techniques and modeling and simulation.