

Computational Initial Value Method for Vibration Analysis of Symmetrically Laminated Composite Plate

Ahmed M. Farag, Wael F. Mohamed, Atef A. Ata, and Burhamy M. Burhamy

Abstract—In the present paper, an improved initial value numerical technique is presented to analyze the free vibration of symmetrically laminated rectangular plate. A combination of the initial value method (IV) and the finite differences (FD) devices is utilized to develop the present (IVFD) technique. The achieved technique is applied to the equation of motion of vibrating laminated rectangular plate under various types of boundary conditions. Three common types of laminated symmetrically cross-ply, orthotropic and isotropic plates are analyzed here. The convergence and accuracy of the presented Initial Value-Finite Differences (IVFD) technique have been examined. Also, the merits and validity of improved technique are satisfied via comparing the obtained results with those available in literature indicating good agreements.

Keywords—Free Vibrations, Initial Value, Finite Differences, Laminated plates.

I. INTRODUCTION

LAMINATED plates are often used in many engineering applications such as aerospace, naval and ocean structures. The great importance of the plate free vibration is due to the necessity of their dynamic characteristics. A proper optimization of the geometry of plate cross-section has to be carried out in order to achieve the required structural performance. For such plates, the governing partial differential equations of motion are solved either by numerical techniques, or experimentally to find the fundamental frequency of vibrations. Nowadays, many researches are devoted to the numerical analysis of the free vibration of plates. However, many problems remain still unsolved exactly. Due to its simplicity, the classical laminated plate theory (CLPT) [1] is widely used for the analysis of laminated plates which are subjected to dynamic loading. More complex plate theories have also been used, such as the first-order shear deformation theory (FSDT) and the third-order laminated theory[1]-[2]-[3]. It is very difficult to obtain the exact solution for the dynamic response of laminated

composite plate. Currently, the exact solution can only be available for certain plate theories applied to simply support rectangular plates [3]. The main problems involving rectangular plates is classified into three distinct categories: (a) plates with all edges simply supported; (b) plates with a pair of opposite edges simply supported; (c) plates which do not classified on one of the above categories. The first and second categories are amenable to straightforward rigorous solutions in terms of the well-known Navier and Levy solutions [1]-[4]. These methods can be simply extended to orthotropic plates. Problems of the third category are difficult to be solved exactly [3]-[5]. Accordingly, rigorous analytical solutions, which satisfy the governing partial differential equations of motion and the boundary conditions exactly, turn out to be rare. Numerical methods have to be used if the problem involves complex geometries and complex boundary conditions. As a result, approximate numerical methods, [4]-[5]-[6], have been proposed for dynamic analysis of the laminated plates. Rayleigh-Ritz method is used in [7]-[8]-[9] to deal with the vibration problem of isotropic and orthotropic plates. More over Rayleigh-Ritz method[10]-[11]-[12] is employed with the method of superposition of normal modes to calculate the dynamic response of laminated plates with different boundary conditions. Many numerical methods have been proposed for the dynamic response analysis of plates. Out of these methods, the Finite Differences method (FD),[13]-[14]-[15], has become the universally applicable technique for solving boundary and initial value problems. Although Finite Element method (FE) [16]-[17], is an extremely versatile and powerful technique, it has certain disadvantages because large quantities of input data make implementation tedious, and one is often compelled to employ automatic mesh and load generation schemes. Also, many lower order elements will not yield acceptable stress results, necessitating the use of stress averaging or interpolation. So a computer core requirement can often be extremely large. Thus, there have been efforts to formulate alternative methods, which lead to the development of the Finite Strip method [2], Transition Matrix method [18], Initial Value method [19]-[20] and boundary element method [21]-[22].

The boundary element method [23]-[24]-[25] has been successfully applied for a great variety of problems, though a major deficiency. It is difficult to apply this method for anisotropic and inhomogeneous solids, as there is no simple applicable Green's function available.

A. M. Farag, Department of Engineering Mathematics and Physics, Faculty of Engineering, Alexandria University, Alexandria, Egypt, (e-mail: afarag59@yahoo.com).

W. F. Mohamed, Department of Engineering Mathematics and Physics, Faculty of Engineering, Alexandria University, Alexandria, Egypt, (e-mail: wfimobarak@gmail.com).

A. A. Ata, Department of Engineering Mathematics and Physics, Faculty of Engineering, Alexandria University, Alexandria, Egypt, (e-mail: atefata@gmail.com).

B. M. Burhamy, Department of Engineering Mathematics and Physics, Faculty of Engineering, Alexandria University, Alexandria, Egypt.

The main objective of the present paper is to offer a new numerical solution for free vibration analysis of symmetrically laminated plates. The capabilities of (IV) and (FD) methods are employed to achieve an improved (IVFD) hybrid numerical technique with reference to the solution for the title problem. Partial differential equation of vibrating plate is transformed at any node by the devices of the finite differences with respect to the neighboring nodes in y -direction. A selected step by step initial integration method is applied in x -direction to solve the transformed differential equation. Some derivatives at the next nodal line are expressed according to trapezoidal rule.

The frequency parameters for such plates are obtained for different laminated composites, fiber orientation angles and boundary conditions. The results are compared with those available in the literature to examine the accuracy and efficiency of the method.

II. LAMINATED PLATE THEORY

Consider the rectangular plate whose dimensions in x and y directions are a and b respectively, as shown in Fig. 1. A number k of layers of fiber reinforced laminated composite lying in the x - y plane is applied to consist the overall thickness h of plate.

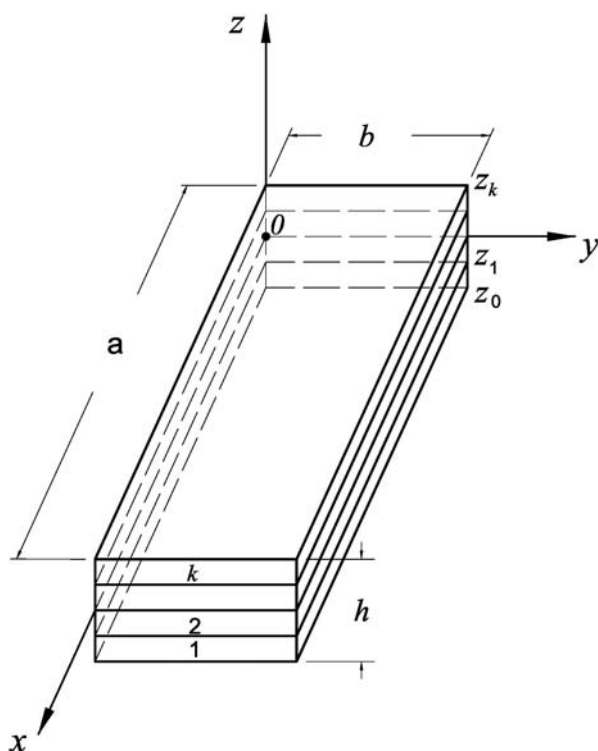

Fig. 1 The coordinate system of the composite laminated plate

The reference plane $z=0$ is located at the un-deformed mid-plane of the plate [26]-[27]. The z -axis is taken as positive upward from the mid-plane. The k^{th} layer is located

between the two planes $z = z_k - 1$ and $z = z_k$. The material principal axes 1 and 2 are oriented at an angle α_k with respect to plate axis x , as shown in Fig. 2. The magnitudes u , v and w denote the displacements in the coordinate directions x , y and z respectively. The displacements u and v can be expressed by w according to Classic Laminated Plate Theory CLPT [28]-[29]-[30] as follows:

$$u = -z\hat{w}_{,x}, \quad v = -z\hat{w}_{,y} \quad (1)$$

where the suffix x or y refers to the partial derivative of \hat{w} with respect to x or y respectively.

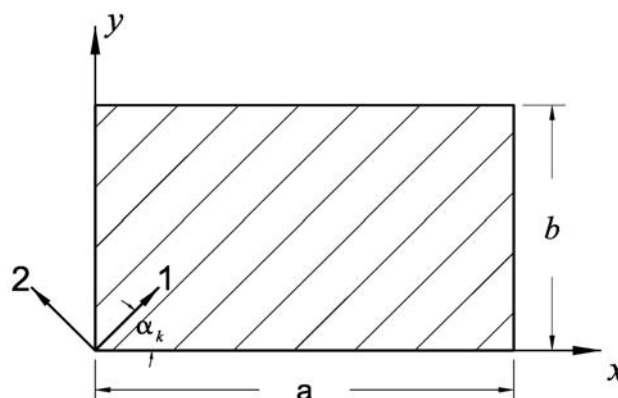

Fig. 2 Geometry and coordinate system of the k^{th} layer of a rectangular plate in the x - y plane with fiber orientation α_k

The strain-displacement relations [31]-[32]-[33] for the plate can be written in the matrix form such as:

$$\begin{Bmatrix} \varepsilon_x \\ \varepsilon_y \\ \gamma_{xy} \end{Bmatrix} = -zLw \quad (2)$$

where the differential operator L is given by:

$$L^T = \begin{bmatrix} \frac{\partial^2}{\partial x^2} & \frac{\partial^2}{\partial y^2} & \frac{\partial^2}{\partial x \partial y} \end{bmatrix}$$

The symbol T denotes transpose and $\varepsilon_x, \varepsilon_y$ and γ_{xy} are the plate strains.

According to generalized Hooke's law, the stress-strain relation for the k^{th} layer in the laminate coordinates is given by:

$$\begin{Bmatrix} \sigma_x \\ \sigma_y \\ \tau_{xy} \end{Bmatrix}^k = \begin{bmatrix} \bar{Q}_{11} & \bar{Q}_{12} & \bar{Q}_{13} \\ \bar{Q}_{21} & \bar{Q}_{22} & \bar{Q}_{23} \\ \bar{Q}_{31} & \bar{Q}_{32} & \bar{Q}_{33} \end{bmatrix}^k \begin{Bmatrix} \varepsilon_x \\ \varepsilon_y \\ \gamma_{xy} \end{Bmatrix} \quad (3)$$

or it is simplified to be in form:

$$\begin{Bmatrix} \sigma_x \\ \sigma_y \\ \tau_{xy} \end{Bmatrix}^k = \bar{Q}^k \begin{Bmatrix} \varepsilon_x \\ \varepsilon_y \\ \gamma_{xy} \end{Bmatrix} \quad (4)$$

where:

$$\bar{Q}^k = TQ^kT^T; T = \begin{bmatrix} l^2 & m^2 & ml \\ m^2 & l^2 & -ml \\ -2ml & 2ml & l^2 - m^2 \end{bmatrix}; m = \sin \alpha_k, l = \cos \alpha_k$$

in which Q^k is the matrix of material constants for the k^{th} layer in the material principal coordinates, whose elements are:

$$Q_{11} = \frac{E_1}{(1 - \nu_{12}\nu_{21})}, \quad Q_{12} = \frac{\nu_{12}E_2}{(1 - \nu_{12}\nu_{21})}, \quad (5)$$

$$Q_{22} = \frac{E_2}{(1 - \nu_{12}\nu_{21})}, \quad Q_{66} = G_{12}, \quad Q_{16} = Q_{26} = 0$$

where E_1 and E_2 are Young's moduli in the directions parallel and perpendicular to the fibers, respectively; G_{12} is the shear modulus and ν_{12} and ν_{21} are Poisson's ratios.

The case of symmetrically stacked laminates is considered. And the bending moment vector is defined as:

$$\begin{Bmatrix} M_x \\ M_y \\ M_{xy} \end{Bmatrix} = -DLw \quad (6)$$

where, the matrix D is the coefficient matrix of the bending stiffness, which is given as:

$$D = \begin{bmatrix} D_{11} & D_{12} & D_{16} \\ D_{12} & D_{22} & D_{26} \\ D_{16} & D_{26} & D_{66} \end{bmatrix} \quad (7)$$

Such that;

$$D_{ij} = \frac{1}{3} \sum_1^k (\bar{Q}_{ij})_k (z_k^3 - z_{k-1}^3) \quad (8)$$

and the shear forces are expressed as:

$$q_x = \frac{\partial M_x}{\partial x} + \frac{\partial M_{xy}}{\partial y}, \quad q_y = \frac{\partial M_y}{\partial y} + \frac{\partial M_{xy}}{\partial x} \quad (9)$$

III. INITIAL VALUE FINITE DIFFERENCES MATHEMATICAL FORMULATION OF LAMINATED PLATE

The lateral mid-plane deflection of the laminated plate is assumed to satisfy the following governing partial differential equation of motion for free vibration [1]-[34]-[35] as:

$$D_{11} \hat{w}_{,xxxx} + 4D_{16} \hat{w}_{,xxy} + 2(D_{12} + 2D_{66}) \hat{w}_{,xyy} + 4D_{26} \hat{w}_{,yyy} + D_{22} \hat{w}_{,yyyy} + I_0 \hat{w}_{,tt} - I_2 [\hat{w}_{,xx}(\hat{w}_{,tt}) + \hat{w}_{,yy}(\hat{w}_{,tt})] = 0 \quad (10)$$

where:

$$I_0 = \sum_1^k (\rho)_k (z_k - z_{k-1})^2, \quad I_2 = \frac{1}{3} \sum_1^k (\rho)_k (z_k^3 - z_{k-1}^3)$$

on which $(\rho)_k$ is the k^{th} mass per unit volume.

The magnitudes $\hat{w}_{,xxxx}$ and $\hat{w}_{,yyyy}$ are the fourth-order partial derivatives of \hat{w} with respect to x and y respectively. By analogy, the other partial derivatives of \hat{w} are written according to the independent variables. To investigate the vibration modes, the displacement is defined as time harmonic function in the form:

$$w(x, y, t) = \hat{w}(x, y) e^{i\omega t} \quad (11)$$

where ω is the circular natural frequency.

Substitution of (11) into (10) yields:

$$D_{11} \hat{w}_{,xxxx} + 4D_{16} \hat{w}_{,xxy} + 2(D_{12} + 2D_{66}) \hat{w}_{,xyy} + 4D_{26} \hat{w}_{,yyy} + D_{22} \hat{w}_{,yyyy} + I_0 \hat{w} - I_2 [\hat{w}_{,xx} + \hat{w}_{,yy}] = 0 \quad (12)$$

The model of $M \times N$ mesh of plate with equal divisions, $H = a/N$ in x -direction and $G = b/M$ in y -direction, is constructed, as shown in Fig. 3.

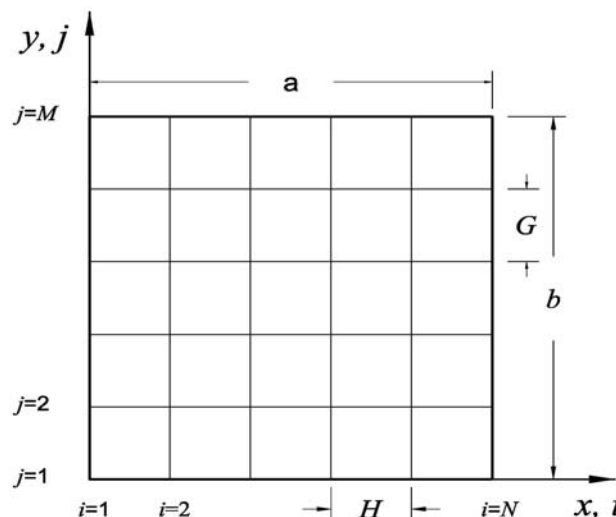

Fig. 3 Plate mesh divisions

In the present paper a step by step integration technique is used by Initial Value method in the x -direction. So the partial derivatives: $\hat{w}_{,xyy}$, $\hat{w}_{,xxxx}$ at any point (i, j) , in (10), are represented in y -direction by the lower displacement derivatives \hat{w} and $\hat{w}_{,xx}$ of four neighborhood points [36]-[37]-

[38], while the derivatives $\frac{\partial^n \hat{w}}{\partial x^n}$; $n=1,2,3,4$ in x -direction are remained. Rearranging, the equation of motion (12) at point (i, j) one can get:

$$\hat{w}_{,xxxx} = -\frac{4D_{16}}{D_{11}} \hat{w}_{,xxy} - \frac{2(D_{12} + 2D_{66})}{D_{11}} \hat{w}_{,xyy} - \frac{4D_{26}}{D_{11}} \hat{w}_{,yyy} - \frac{D_{22}}{D_{11}} \hat{w}_{,yyyy} + \frac{\omega^2}{D_{11}} \{I_0 \hat{w} - I_2 [\hat{w}_{,xx} + \hat{w}_{,yy}]\} \quad (13)$$

According to the basics of the Finite Differences [39]-[40], one can obtain:

$$(\hat{w}_{,xyy})_{(i,j)} = \frac{1}{2G^3} \left[(\hat{w}_{,x})_{(i,j+2)} - 2(\hat{w}_{,x})_{(i,j+1)} + 2(\hat{w}_{,x})_{(i,j-1)} - (\hat{w}_{,x})_{(i,j-2)} \right] \quad (14)$$

$$(\hat{w}_{,xxy})_{(i,j)} = \frac{1}{G^2} \left[(\hat{w}_{,xx})_{(i,j+1)} - 2(\hat{w}_{,xx})_{(i,j)} + (\hat{w}_{,xx})_{(i,j-1)} \right] \quad (15)$$

$$(\hat{w}_{,xxx})_{(i,j)} = \frac{1}{2G} \left[(\hat{w}_{,xxx})_{(i,j+1)} - (\hat{w}_{,xxx})_{(i,j-1)} \right] \quad (16)$$

$$(\hat{w}_{,yyy})_{(i,j)} = \frac{1}{G^4} \left[\hat{w}_{(i,j-2)} - 4\hat{w}_{(i,j-1)} + 6\hat{w}_{(i,j)} - 4\hat{w}_{(i,j+1)} + \hat{w}_{(i,j+2)} \right] \quad (17)$$

Substitution from (14) to (17) into (13), the nodal equation of motion of laminated plates is reduced to:

$$\begin{aligned} (\hat{w}_{,xxxx})_{(i,j)} = & \beta_1 \left[(\hat{w}_{,xxx})_{(i,j+1)} - (\hat{w}_{,xxx})_{(i,j-1)} \right] \\ & + \beta_2 \left[(\hat{w}_{,xx})_{(i,j+1)} - 2(\hat{w}_{,xx})_{(i,j)} + (\hat{w}_{,xx})_{(i,j-1)} \right] \\ & + \beta_3 \left[(\hat{w}_{,x})_{(i,j+2)} - 2(\hat{w}_{,x})_{(i,j+1)} + 2(\hat{w}_{,x})_{(i,j-1)} - (\hat{w}_{,x})_{(i,j-2)} \right] \\ & + \beta_4 \left[\hat{w}_{(i,j-2)} - 4\hat{w}_{(i,j-1)} + 6\hat{w}_{(i,j)} - 4\hat{w}_{(i,j+1)} + \hat{w}_{(i,j+2)} \right] \\ & + \beta_5 \left[I_0 \hat{w} - I_2 (\hat{w}_{,xx} + \hat{w}_{,yy}) \right] \end{aligned} \quad (18)$$

where:

$$\beta_1 = -\frac{4D_{16}}{D_{11}} \frac{1}{2G}, \quad \beta_2 = -\frac{2(D_{12} + 2D_{66})}{D_{11}} \frac{1}{G^2},$$

$$\beta_3 = -\frac{4D_{26}}{D_{11}} \frac{1}{2G^3}, \quad \beta_4 = -\frac{D_{22}}{D_{11}} \frac{1}{G^4}, \quad \beta_5 = \frac{\omega^2}{D_{11}}$$

The selected integration method used for solving the reduced differential equation in x -direction is the trapezoidal method, where some derivatives applied at a point (i, j) are expressed as:

$$\hat{w}_{(i,j)}^{(n)} = \hat{w}_{(i-1,j)}^{(n)} + \frac{H}{2} \cdot \left[\hat{w}_{(i-1,j)}^{(n+1)} + \hat{w}_{(i,j)}^{(n+1)} \right]; \quad n=0,1,2,3 \quad (19)$$

where $\hat{w}_{(i,j)}^{(n)}$ is the n -order derivative of the displacement $\hat{w}_{(i,j)}$ at a point (i, j) with respect to x .

The procedure of the step by step integration is explained in the following steps:

Step1: Assuming initial values at starting line $i = 1$

Along edge $i = 1$, two quantities of the deflections and their derivatives $\hat{w}_{(1,j)}^{(n)}$; $n=1,2,3$, $j=1,2,3,\dots,M$ are known from the boundary conditions at this edge where other values are assumed. For example, let the boundaries at all plate edges are being simply supported. So at $i = 1$ because the deflection and moment at point (i, j) are equal zero, then $\hat{w}_{(1,j)} = 0$, $(\hat{w}_{,xx})_{(1,j)} = 0$ for all $j=1,2,3,\dots,M$. At the same edge $i = 1$, the other values $(\hat{w}_{,x})_{(1,j)}$ and $(\hat{w}_{,xxx})_{(1,j)}$, for all $j=1,2,3,\dots,M$, must be assumed in an alternative way as shown in table I. Then by applying (18) at line $i = 1$ and $j=1,2,3,\dots,M$ the corresponding values of the fourth derivative $(\hat{w}_{,xxxx})_{(1,j)}$ are obtained. Hence all values at line $i = 1$ are known.

TABLE I
ASSUMED INITIAL VALUES FOR A SIMPLY SUPPORTED EDGE ($i = 1$)

Solutions types	Assumed initial value			
	Solution R_s	Location (j)	$(\hat{w}_{,x})_{(1,j)}$	$(\hat{w}_{,xxx})_{(1,j)}$
Homogeneous solutions	R_1	1	θ_1	0
	R_2	2	θ_2	0
	R_3	3	θ_3	0
	*	*	*	0
	*	*	*	0
	*	*	*	0
	R_M	M	θ_M	0
	R_{M+1}	1	0	q_1
	R_{M+2}	2	0	q_2
	*	*	0	*
	*	*	0	*
	*	*	0	*
	R_{2M}	M	0	q_M

Note: the assumed initial values q and θ are nonzero values.

Step2: Estimating derivatives values for the subsequent line

Generally, if all values at the line i are determined, one can transmit to line $(i+1)$. So, at the line $i = 2$, the partial derivatives $(\hat{w}_{,xxx})_{(2,j)}$ for all j s are assumed to take the same values of the previous line $i = 1$ for each corresponding point j . Accordingly, deflection \hat{w} and the partial derivatives $\hat{w}_{(2,j)}^{(n)}$; $n=1,2,3$, $j=1,2,3,\dots,M$ at line $i = 2$ are calculated from trapezoidal rule, (19), from the known values of the

corresponding values at the previous line $i = 1$. Consequently, by substituting the obtained quantities from trapezoidal rule into (18), the values of the fourth derivative $(\hat{w}_{,xxxx})_{(2,j)}$ for all j_s can be determined.

Step3: Calculating the correct values by iteration technique

If the determined values of the fourth derivative $(\hat{w}_{,xxxx})_{(i,j)}$, from (18), are not coincide with the assumed ones, then the new determined value is taken as the assumed value. So the procedure of step 2 has to be repeated for all possible $j = 1, 2, 3, \dots, M$, until the assumed value agrees as closely as with the deduced one for all j_s .

Step4: Integrating the entire mesh of plate

Steps 2 and 3 are applied to the next lines $i; i = 3, 4, 5, \dots, N$. Since the previous steps were applied to line $i = N$, Then the deflection \hat{w} and their partial derivatives, $\frac{\partial^n \hat{w}}{\partial x^n}; n = 1, 2, 3, 4$, were found at the points of the terminal edge.

Step5: Superposition of homogenous solutions

Of course, as there are assumed initial values at the beginning edge $i = 1$, so the terminal boundary conditions are not satisfied. Hence it is a necessary to apply $2M$ - homogeneous solutions, each homogeneous solution is corresponding to each assumed initial value at single point $(1, j)$. The integration procedure explained previously is applied for each solution across the structure until the terminal edge $i = N$ is reached. So there will be $2M$, sets of displacement quantities at each point (i, j) of the mesh (corresponding to each of the $2M$ - assumed initial values). The superposition method can be used to deal with individual solutions.

Step6: Satisfying the boundary condition at the end edge $i = N$

Because the individual solutions of the end edge $i = N$ will not be satisfied with boundary condition, it is necessary to force the superimposed solutions to coincident with the boundary conditions. For example, the deflection and its second partial derivative must be zero for simply supported edge, and then the following conditions must be applied for each j :

$$\left\{ \begin{matrix} (\hat{w})_{(n,j)} \\ (\hat{w}_{,xx})_{(n,j)} \end{matrix} \right\} = \left\{ \begin{matrix} 0 \\ 0 \end{matrix} \right\}; j = 1, 2, \dots, M \quad (20)$$

The true solution of any displacement quantities or one of its derivatives is the sum of the $2M$ -homogeneous solutions:

$$\hat{w}^{(n)} = \sum_{s=1}^{2M} b_s \hat{w}_s^{(n)}; n = 0, 1, 2, 3, 4, s = 1, 2, 3, \dots, 2M \quad (21)$$

where:

$\hat{w}^{(n)}$ is the true n -order partial derivative of the displacement of the superimposed solutions, for simply support terminal edge, $\hat{w}^{(0)} = \hat{w} = 0, \hat{w}^{(2)} = \hat{w}_{,xx} = 0$.

$\hat{w}_s^{(n)}$ is the n -derivative of the displacement of the homogenous solutions.

The unknown factors $b_s; s = 1, 2, 3, \dots, 2M$ are determined by satisfying the boundary conditions of the terminal edge $i = N$.

Equation (21) will be expressed in a matrix form, such as:

$$[\mathfrak{R}_s][b_s] = [0]; s = 1, 2, 3, \dots, 2M \quad (22)$$

Where \mathfrak{R}_s is $2M \times 2M$ known matrix and b_s is $2M$ unknown vector.

Step7: Calculating the circular natural frequency of plate

For a non-trivial solution of (22), the determinate of $[\mathfrak{R}_s]$ must be zero.

All values that satisfies zero determinate of $[\mathfrak{R}_s]$ are the natural frequencies ω of plate. The corresponding displacement of obtained natural frequency is the mode shape [41]-[42]-[43]:

$$(\hat{w})_{(i,j)} = \sum_{s=1}^{2M} b_s (\hat{w}_s)_{(i,j)}; s = 1, 2, 3, \dots, 2M \quad (23)$$

IV. DIFFERENT TYPES OF BOUNDARY CONDITIONS

Dealing with the boundary conditions, at edges of the rectangular plate, plays an important rule when applying the IVFD method. The assumed initial values at the edge $i = 1$ are depending on the boundary conditions along this edge.

The following table shows the different types of boundary conditions and the assigned initial values at first edge for all j_s for different boundary conditions [19].

TABLE II
BOUNDARY CONDITIONS

Boundary Conditions	Simple support	Clamped support	Free
Condition at edges at $i=1$ or $i=N$	$\hat{w}_{(i,j)} = 0$ $(\hat{w}_{,xx})_{(i,j)} = 0$	$\hat{w}_{(i,j)} = 0$ $(\hat{w}_{,x})_{(i,j)} = 0$	$V_{x(i,j)} = 0$ $M_{x(i,j)} = 0$;
Condition at edges at $j=1$ or $j=M$.	$\hat{w}_{(i,j)} = 0$ $\hat{w}_{(i,j-1)} = -\hat{w}_{(i,j+1)}$	$\hat{w}_{(i,j)} = 0$ $\hat{w}_{(i,j-1)} = \hat{w}_{(i,j+1)}$	$M_{x(i,j)} = 0$ $V_{x(i,j)} = 0$
Assumed initial values at edge $i=1$	$(\hat{w}_{,x})_{(1,j)}$ $(\hat{w}_{,xxx})_{(1,j)}$	$(\hat{w}_{,xx})_{(i,j)}$ $(\hat{w}_{,xxx})_{(i,j)}$	$\hat{w}_{(i,j)}$ $(\hat{w}_{,x})_{(i,j)}$

The boundary conditions along the two edges $j=1$ and $j=M$ are expressed by finite differences basics to represent the displacement at the outer virtual points of these edges as shown in Table II.

V. PARTICULAR TYPES OF PLATES

A. Orthotropic Plate

The one layer orthotropic material is characterized by the fact that the mechanical elastic properties have two perpendicular planes of symmetry[44]-[45]. Consequently, elastic constants are defined as;

$$D_{11} = \frac{E_1 h^3}{12(1-\nu_{12}\nu_{21})}, D_{22} = \frac{E_2 h^3}{12(1-\nu_{12}\nu_{21})},$$

$$D_{66} = \frac{G_{12} h^3}{12}, D_{12} = \nu_{12} D_{22} = \nu_{21} D_{11} \quad (24)$$

Using the Kirchhoff hypotheses, the governing differential equation of motion for free vibration of the orthotropic plate can be represented as follows [46]-[47]:

$$\hat{w}_{,xxxx} + \frac{2(D_{12} + 2D_{66})}{D_{11}} \hat{w}_{,xyxy} + \frac{D_{22}}{D_{11}} \hat{w}_{,yyyy} - \lambda^2 \hat{w} = 0 \quad (25)$$

where: $\lambda^2 = \frac{\rho h \omega^2}{D_{11}}$ is the natural frequency parameter

B. Isotropic Plate:

The isotropic plate is expressed from orthotropic plate, when $D_{11} = D_{22} = 2(D_{12} + 2D_{66}) = D$. So the partial differential equation of motion of plate takes the form [48]:

$$\hat{w}_{,xxxx} + 2\hat{w}_{,xyxy} + \hat{w}_{,yyyy} - \lambda^2 \hat{w} = 0 \quad (26)$$

where: $\lambda^2 = \frac{\rho h \omega^2}{D}$, $D = \frac{Eh^3}{12(1-\nu^2)}$ in which E and ν are the modulus of elasticity and Poisson's ratio respectively.

VI. NUMERICAL VERIFICATION AND DISCUSSION

Case I: Laminated Cross-ply Symmetrical Plate

In this case, the treated problems are related to a four-ply and a three-ply composite plates with fully simply supported edges SSSS. Each layer is of a high-modulus graphite-epoxy material. The properties of this material are shown in the following table:

TABLE III
PROPERTIES OF GRAPHITE-EPOXY MATERIAL

Material	Specifications			
	E_1/E_2	G_{12}	ν_{12}	ρ t/m
M1	20	$0.5E_2$	0.25	1.54

The normalized dimensionless natural frequency parameter Ω is defined as follows:

$$\Omega = \omega \left(\frac{a^2}{\pi^2} \right) \sqrt{\frac{\rho h}{D_{22}}}$$

The results of Ω for the treated problem are compared with the exact solution [1] showing a well convergence as shown in table IV. This convergence is due to exceeding of mesh nodal lines. As seen from results, the error decreases and be stable when the number N of the nodal lines in direction of initial value method be greater than the number M of nodal lines in the other direction.

TABLE IV
CONVERGENT RESULTS DUE TO EXCEEDING OF MESH NODAL LINES

Material: M1					
Plate specifications					
$\alpha_k = [0\ 90\ 90\ 0]$					
$(a/h) = 100$					
N	M	Ω	N	M	Ω
12	12	2.596	12	6	2.5860
16	12	2.575	12	8	2.5847
20	12	2.575	12	10	2.5885
24	12	2.558	12	12	2.5961
28	12	2.558	12	14	2.5885
32	12	2.558	12	16	2.5885
36	12	2.558	12	18	--

The dimensionless natural frequency parameter Ω deduced from the new method is illustrated in table V. The results are obtained for $N=12$, $M=42$ and compared with the exact values showing good agreements. Also, the natural frequency parameters are obtained for the variation of aspect ratio from 0.5 to 3.0 as shown in table VI.

TABLE V
NORMALIZED NATURAL FREQUENCY PARAMETER Ω
OFSSSS SQUARE PLATE

Material: M1		
Plate specifications		
$\alpha_k = [0\ 90\ 90\ 0]$		
$(a/h) = 100$		
Modes	IVFD	Reddy [1]
1,1	2.56	2.63
2,1	4.68	4.91
1,2	9.29	9.35
2,2	10.28	10.55
3,2	13.03	13.82
1,3	20.84	20.75
2,3	21.4	21.57
3,3	23.03	23.74

TABLE VI

NORMALIZED NATURAL FREQUENCY PARAMETER $\bar{\Omega}$
 OF SSSS SQUARE PLATE FOR DIFFERENT ASPECT RATIOS

Plate specifications	Material: M1	
	$\alpha_k = [0/90/90/0]$	
	$(a/h) = 100$	
$\bar{\Omega}_{(1,1)}$	a/b	IVFD Reddy[1]
	0.5	9.26 9.35
	1.0	2.54 2.63
	1.5	1.49 1.53
	2.0	1.18 1.22
	2.5	1.09 1.11
3.0	1.04 1.07	

Another case for different orthotropicity ratios is studied for fully simply supported square plate with material M1. The normalized dimensionless natural frequency parameters are compared with those obtained by Nallim [50] and Khdir [49] as shown in Tables VII and VIII. The results show a good agreement for the lower mode of vibration.

TABLE VII

NORMALIZED NATURAL FREQUENCY PARAMETER $\bar{\Omega}$, SSSS, SQUARE PLATE

Plate specifications	Material: M1					
	$\alpha_k = [0/90/0]$					
	$(a/h) = 100$					
E_1/E_2	10		20		30	
Modes	IVFD	Nallim [50]	IVFD	Nallim [50]	IVFD	Nallim [50]
1,1	1.64	1.68	1.38	1.41	1.02	1.08
2,1	2.38	2.48	2.19	2.21	1.77	1.89
3,1	4.16	4.32	3.75	3.92	3.38	3.47
1,2	6.30	6.31	5.19	5.19	3.68	3.75
2,2	6.61	6.74	5.48	5.66	4.28	4.32

TABLE VIII

NORMALIZED NATURAL FREQUENCY PARAMETER $\bar{\Omega}$, SSSS, SQUARE PLATE

$\bar{\Omega} = \alpha a^2 \sqrt{\frac{\rho h}{E_2}}$	Plate specification s	Material: M1			
		$\alpha_k = [0/90/90/0]$			
		$(a/h) = 5$			
(E_1/E_2)	10	20	30	40	
IVFD	10.14	13.47	16.17	18.54	
Khdeir[49]	10.65	13.94	16.60	18.89	

The mode shape is drawn for different modes of the studied plate of material M1 as shown in graphs from Fig. 4-a to Fig. 4-h in the appendix.

Case 2: Orthotropic Plate

Orthotropic plates with two different types of materials, shown in Table IX, are investigated for the cases of fully clamped square plate CCCC. Another case of simple-simple-clamped-clamped SSCC is studied. The results are listed in table X for material M2 and in Table XI for material M3. The natural frequency parameters λ are calculated for the first three modes of vibration and compared with those obtained Exacted and with Finite Element Method (FEM) [41].

TABLE IX

PROPERTIES OF ORTHOTROPIC PLATE MATERIALS

Material	Specifications				
	E_1 (Gpa)	E_2 (Gpa)	G_{12} (Gpa)	ν_{12}	ρ t/m
M2	185	10.5	7.3	0.28	1.6
M3	76	5.6	2.3	0.34	1.46

TABLE X

DIMENSIONLESS NATURAL FREQUENCY PARAMETER λ

$\lambda = \alpha a^2 \sqrt{\frac{\rho h}{D_{11}}}$	Material: M2 orthotropic			
	Plate dimensions $a \times b = 1.0m \times 1.2m$			
	$(a/h) = 100$			
Boundary conditions		IVFD	Exact [41]	FEM [41]
CCCC	1,1	22.84	23.04	23.13
	1,2	62.44	62.25	62.41
	2,1	25.18	25.80	26.01
SSCC	1,1	15.91	16.16	16.16
	1,2	50.54	50.69	50.69
	2,2	51.00	51.40	51.40

TABLE XI

DIMENSIONLESS NATURAL FREQUENCY PARAMETER λ

$\lambda = \alpha a^2 \sqrt{\frac{\rho h}{D_{11}}}$	Material: M3 orthotropic			
	CCCC square plate			
	$(a/h) = 100$			
Modes	a/b	IVFD	Exact [41]	FEM [41]
	1.0	1,1	23.50	23.52
1,2		62.73	62.72	62.72
2,1		28.74	29.26	29.59
0.5	1,1	22.56	22.56	22.562
	1,2	62.13	61.93	62.09
	2,1	23.13	23.23	23.23

Case 3: Isotropic Plate

A square Isotropic plate is considered with $E = 2.0 \times 10^7$ t/m² and $\nu = 0.3$. The natural frequency dimensionless parameter $\lambda = \alpha a^2 \sqrt{\frac{\rho h}{D}}$ is determined for different cases of boundary conditions in the following tables:

TABLE XII

DIMENSIONLESS NATURAL FREQUENCY PARAMETER λ

Modes	Isotropic SSSS square plate		
	$(a/h) = 100$		
	IVFD	Farag [18]	Civalek [33]
1,1	19.6922	19.7392	19.7586
2,1	49.4636	49.3480	49.7900
1,2	49.4397	49.3480	49.7900
2,2	78.2108	78.9568	79.2613
3,1	94.2291	--	--
3,2	123.9794	--	--

TABLE XIII
 DIMENSIONLESS NATURAL FREQUENCY PARAMETER λ

Boundary condition	Modes	Isotropic square plate (a/h) = 100			
		IVFD	Farag [18]	Xing & Liu [41]	Sakata & Takahshi [41]
		CCCC	1,1	35.445	36.052
CCCC	1,2	73.408	73.698	72.899	73.405
	3,1	132.300	--	131.629	131.902
CSCS	1,1	28.284	28.950	--	--
	1,2	69.500	69.320	--	--
	2,1	54.204	54.743	--	--

The results are calculated for different modes of vibrations yielding a good accuracy in comparison with those of other literature.

VII. CONCLUSION

The developed Initial Value-Finite Differences method IVFD is successfully applied for free vibration analysis of symmetrically laminated plates with different combinations of boundary conditions. Results show that the natural frequencies calculated using the IVFD method agreed closely with the results in the published literature. The solutions converge rapidly for small number of nodal lines of finite differences direction when the number of nodal lines of initial value direction increases. However, it is noticed that the number of the nodal lines in the direction of the initial value method have to be greater than the number of the nodal lines chosen for the other direction of finite difference method. This difference is due to the iteration involved in the initial value technique. In addition, the method has been easily used in the analysis of different materials types of such plates as laminated, orthotropic and isotropic. The method can be extended to in the future work to investigate the dynamic problems of different shapes of such plates as, circular plate or stepped plate or plates with hollow.

APPENDIX

Different Modes of vibration for laminated cross-ply plate cited in Table III.

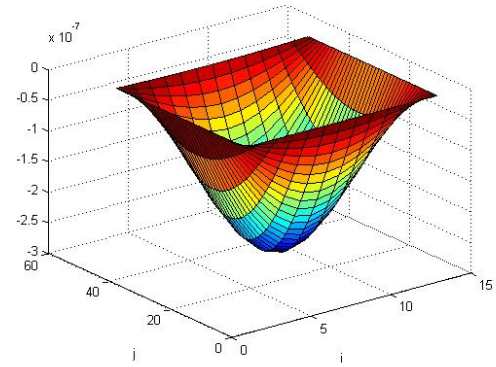

Fig. 4-a Laminated SSSS plate, $\lambda^2 = 2.558$

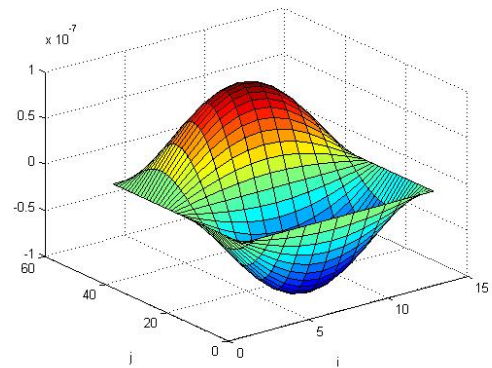

Fig. 4-b Laminated SSSS plate, $\lambda^2 = 9.2901$

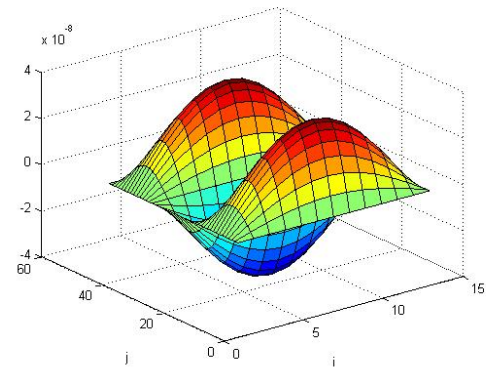

Fig. 4-c Laminated SSSS plate, $\lambda^2 = 20.8454$

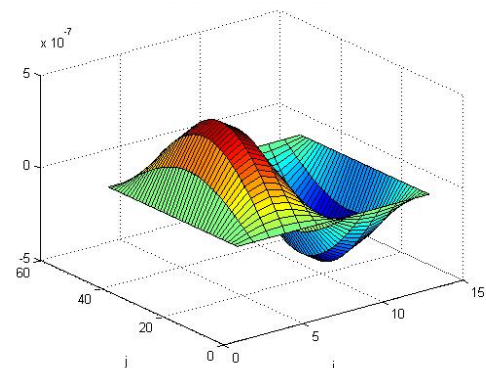

Fig. 4-d Laminated SSSS plate, $\lambda^2 = 4.6832$

REFERENCES

- [1] J. N. Reddy "Mechanics of Laminated Composite plates and shells Theory and Analysis", library of congress, 1997.
- [2] Y.Y. Wang, K.Y. Lam, G.R. Liu "A strip element method for the transient analysis of symmetric laminated plates", pergamon, International Journal of Solids and Structures vol. 38, pp, 241-259, (2001).
- [3] A.A., Khdeir, J.N., Reddy. "Exact solution for the transient response of symmetric cross-ply laminates using a higher-order plate theory". Composite Science and Technology 34, 205-224, 1989.
- [4] H.Thai, S.Kim, "Levy-type solution for free vibration analysis of orthotropic plates based on two variable refined plate theory", Elsevier, Applied Mathematical Modeling 36, pp, 3870-3882, 2012.
- [5] T. Kant, K. Swaminathan " Analytical solutions for the static analysis of laminated composite and sandwich plates based on a higher order refined theory" Elsevier, Composite Structures. vol. 56, pp. 329-344, 2002.
- [6] H. Yunshan "Dsc-Ritz method for the free vibration analysis of mindlin plate" Msc, department of computer science, national university of singapore, 2003.
- [7] S.Guenfoud, S.V.Bosakov, F.Debra" A Ritz's method based solution for the contact problem of a deformable rectangular plate on an elastic quarter-space" International Journal of Solids & Structures, Elsevier, 47 (14-15): 1822- 1829, 2010.
- [8] M. A. El-Sayad, S.A. Ghazy "Rayleigh-Ritz Method for Free Vibration of Mindlin Trapezoidal Plates" International Journal of Emerging Technology and Advanced Engineering, Volume 2, Issue 5, May 2012)
- [9] G. M. Oosterhout, P. J. Van Derhoogt and R. M. Spiering. "Accurate calculation methods for natural frequencies of plates with special attention of the higher modes" Journal of Sound and Vibration" vol. 183(1), pp. 33-47, 1995.
- [10] L.R. Chung and T.Y. Chung "Vibration Analysis of Symmetrically Laminated Composite Rectangular Plates" Proceedings of the Third (1993) International Offshore and Polar Engineering Conference, Vol. (IV), Singapore, 6-11 June, 1993.
- [11] R. Kolar "Dynamics of Shear Deformable Laminated Composites Using Raleigh Ritz Method" NASA Dryden Flight Research Center, Dryden, California. Department of Aeronautics & Astronautics, Naval Postgraduate School, 699 Dyer Road, Idg 234, Rm 245, Monterey, CA 93943, U.S.A, 2002.
- [12] S. O. Eruslu and M. A.Gdu "Free vibration analysis of short fiber reinforced laminated plates with first shear deformation theory" Turkish J. Eng. Env. Sci. 36, 95 – 107, (2012).
- [13] A.Ergun, N.Kunbasar, "A new approach of improved finite difference scheme on plate bending analysis", Scientific research and essays vol.6(1), pp, 6-17, 2011.
- [14] C.B.Dolicinan, V.B. Nikolic, D.C. Dolicanin, "Application of finite difference method to study of the phenomenon in the theory of thin plates", Appl. Math. Inform. And Mech. Vol.2 ,1 , pp, 29-43, 2010.
- [15] R. J. LeVeque, "Finite difference methods for ordinary and partial differential equations: steady-state and time-dependent problems", the Society for Industrial and Applied Mathematics, 2007.
- [16] R. Pedro. "Geometrically non-linear oscillations of composite laminated plates by the hierarchical finite element method" M.sc in computational methods in sciences and engineering , university of Coimbra, 2004.
- [17] A. K. Noor , M. D. Mnthers "Shear-flexible finite element models of laminated plates and shells" National aeronautics and space administration" Lnrzglye Resecrcrh Ceizter Hampton, v a. 23665 Washington D.C. December, 1975.
- [18] A.M.Farag, "Mathematical analysis of free and forced vibration of rectangular plate" , Ph.D Thesis, Faculty of engineering, Alexandria university, 1994.
- [19] H. Al-Khaiat, H.H.West., "Analysis of plates by the initial value method". Computer & structure vol.24 No.3, pp, 475-483, 1986.
- [20] H. Al-Khaiat, "free vibration analysis of orthotropic plates by the initial value method". Computer & structure vol.33 No.6, pp, 1431-1435, 1989.
- [21] A.d.Reis, E.L.Albuquerque, F.L.Torsani "Computation of moments and stresses in laminated composite plates by the boundary element method", Elsevier, Engineering and analysis with boundary elements, 35, pp, 105-113, 2011.

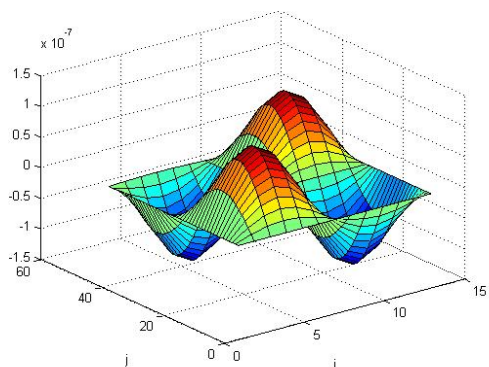

Fig. 4-e Laminated SSSS plate, $\lambda^2 = 10.2827$

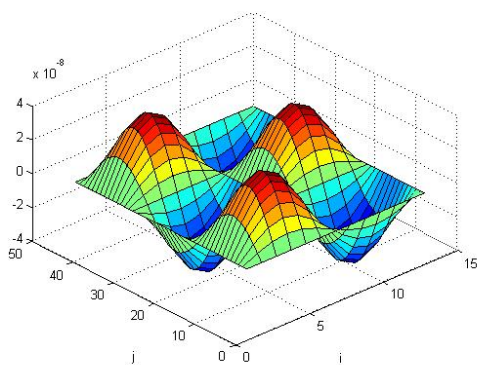

Fig. 4-f Laminated SSSS plate, $\lambda^2 = 21.4054$

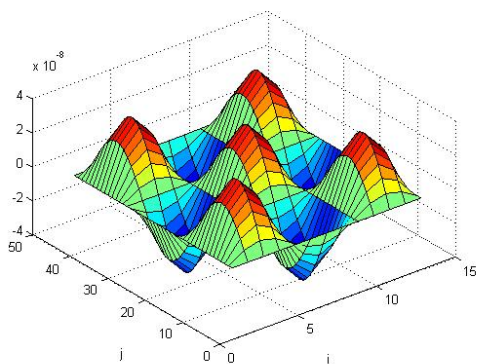

Fig. 4-g Laminated SSSS plate, $\lambda^2 = 23.0343$

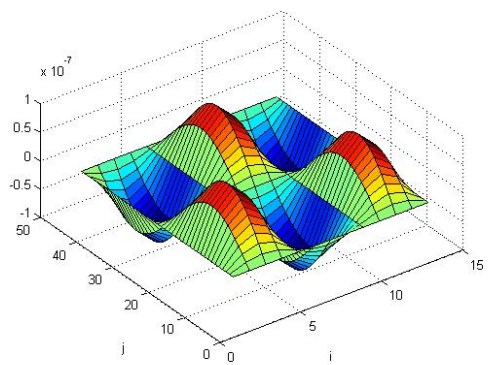

Fig. 4-h Laminated SSSS plate, $\lambda^2 = 13.0316$

- [22] E.L.Albuquerque, P.Sollero, W.S. Venturini, M.H.Aliabadi, "Boundary element analysis of anisotropic Kirchhoff plates", Elsevier, International journal of solids and structures 43,pp.4029-4046, 2006.
- [23] W. Portilho de Paiva, P. Sollero and E. L. Albuquerque, "Treatment of hyper singularities in boundary element anisotropic plate bending problems" Latin American Journal of Solids and Structures 1,pp , 49-73, (2003).
- [24] G. D. Hatzigeorgiou, D. E. Beskos, "Static and dynamic analysis of inelastic solids and structures by the BEM", Journal of the Serbian Society for Computational Mechanics / Vol. 2 / No. 1, 2008 / pp. 1-27.
- [25] W. Portilho de Paiva, P. Sollero and E. L. Albuquerque, "Treatment of hyper singularities in boundary element anisotropic plate bending problems" Latin American Journal of Solids and Structures 1,pp , 49-73, (2003).
- [26] W. Han, M. pety "Lineear vibration Analysis of Laminated Rectangular Plates Using The Hierarchical Finite Element Method—I. Free Vibration Analysis." Pergamon , computer & structures vol. 61,No. 4,pp. 705-712, 1996.
- [27] G. Davi, A. Millazzo "A meshfree method for tranverse vibration of anisotropic plates" pergamon, International Journal of solid & structures vol. 40,pp. 5229-5249, 2003.
- [28] J.N., Reddy, E.J. Barebero, "A plate bending element based on a generalized laminated plate theory", International journal of numerical methods in engineering, vol. 28, pp, 2275-2292, 1989.
- [29] C. Wanji, W. Zhen, "A Selective Review on Recent Development of Displacement-Based Laminated Plate Theories", Recent Patents on Mechanical Engineering, vol 1, pp29-44, 2008 .
- [30] L.G.Nallim, F.J. Bellomo, R.D. Quinteros, and S. Oller, "Dynamical Analysis of long fiber-reinforced laminated plates with elastically restrained edges", Hindawi publishing corporation, Advanced in acoustic and vibration, vol. 2012.
- [31] M. Haddad, Y. Gourinat, M. Charlotte, "Equivalence Theory Applied to Anisotropic Thin Plates", scientific research engineering, vol 3,pp 669-67, 2011.
- [32] S.T. chow, K.M. Liew, K.Y. Lam "Transverse Vibration of Symmetrically Laminated Rectangular Composite Plates", computer & structures vol. 20,pp213-226, 1992.
- [33] O. Civalek, O. Kiracioglu "discrete singular convolution for free vibration analysis of anisotropic plates", Mathematical and computational applications. vol. 12, No. 3, pp. 151-160, 2007.
- [34] L. Demasi "Quasi-3D analysis of free vibration of anisotropic plates", Elsevier, Composite Structures. vol. 74, pp. 449-457, 2006.
- [35] R.C. batra, J. Jin "Natural frequencies of functionally graded anisotropic rectangular plate", Elsevier, Journal of sound and vibration. vol. 282, pp. 509-56, 2005.
- [36] W.Yu, R. Mitra, T. Su, Y Liu, X. Yang, "Parallel finite-difference time-domain method" ARTECH HOUSE, 2006.
- [37] D. J. Duffy, "Finite Difference Methods in Financial Engineering A Partial Differential Equation Approach", cs-books@wiley.co.uk, John Wiley & Sons Ltd, The Atrium, Southern Gate, Chichester, West Sussex PO198SQ, England, 2006.
- [38] I. Chern "Finite difference methods for solving differential equations", Department of Mathematics, book, National Taiwan University, 2009.
- [39] J. Awrejcewicz, "Numerical Analysis – Theory and Application", Published by In. Tech, Janeza Trdine 9, 51000 Rijeka, Croatia, 2011.
- [40] A.A. Kuleshov, "Finite difference method for the model of small transverse vibrations in thin elastic plates" Proceeding of the 4th WSEAS international conference of finite differences, pp, 19-22, 2010.
- [41] Y.F.Xing, B.Liu, "New exact solutions for free vibrations of thin orthotropic rectangular plates", Elsevier, Composite Structure, 89, pp, 567-574, 2009.
- [42] A.K.Gupta, N.Agarwal, H.Kaur, "Free vibration analysis of non-homogeneous orthotropic visco-elastic elliptic plate of non-uniform thickness", Int. J. of Appl. Math and Mech. 7(6): pp, 1-18, 2011.
- [43] A.M. Farag, and A.S. Ashour "Free vibration of orthotropic skew plates", Journal of vibration and acoustics, ASMF, vol. 122, pp, 313-317, 2000.
- [44] R.P.Shimpi, H.G.Patel, "A two variable refined plate theory for orthotropic plate analysis." Aerospace Engineering, Indian Institute of Technology Bombay, pp, 6783-6799, 2003.
- [45] H. Khov a, W. L. Lib, Ronald F. Gibson An accurate solution method for the static and dynamic deflections of orthotropic plates with general boundary conditions Composite Structures 90 (2009) 474–481
- [46] H. Thai, S. Kim "Levy-type solution for free vibration analysis of orthotropic plates based on refined plate theory" Elsevier, Applied mathematical modeling. vol. 36, pp. 3870-3882, 2012.
- [47] N. Baddour, "Recent Advances in Vibrations Analysis", Published by InTech, Janeza, Trdine 9, 51000 Rijeka, Croatia, 2011.
- [48] S. Timoshenko, S. Woiowesky-krieger, "Theory of plates and shells", McGRAW-HILL, 1959.
- [49] A.A. khdeir, L. Librescu" Analysis of symmetric cross-ply laminated elastic plates using a higher-order theory: Part II—Buckling and free vibration" Composite Structures, Volume 9, Issue 4, Pages 259–277, 1988.
- [50] L. G. Nallim, R. O. Grossi. "Vibration of angle-ply symmetric laminated composite plates with edges elastically restrained", Composite structures, vol.81, pp88-83, 2007.



Ahmed M. Farag was born in El- Bohaira, Egypt in 1959. He received his B.Sc. Degree with Honor in 1982 in Civil Engineering and his MS.c and Ph.D degrees in Engineering Mathematics from faculty of Engineering, Alexandria University in 1987 and 1994, respectively. His Ph.D thesis was comprised of a study of free and forced vibration of rectangular plates. His research interests include computer graphics, geometric modeling, mathematics and vibration of structures.

He is a professor and the head of Engineering Mathematics department in the Faculty of Engineering - Alexandria University. He also is the executive manager of the Specialized Scientific Programs SSP in the Faculty of Engineering - Alexandria University. Author can be reached by: E-mail:afarag59@yahoo.comTel: +201222410680 or through postal Address: Department of Engineering Mathematics and Physics, Faculty of Engineering, Alexandria University, Alexandria, 21544 -Egypt.

Wael F. Mohamed was born in Egypt in 1979. He received his BS.c Degree in Civil Engineering from Alexandria University in Egypt in 2000. After his graduation he joined the same university as a Demonstrator where he obtained his MS.c. Degree in Engineering Mathematics in 2006.

He works as ASSISTANT LECTURE at Department of Engineering Mathematics & Physics, Faculty of Engineering, Alexandria University, Egypt. Research interests; Geometry and Vibration. Author can be reached by: E-mail: wfmobarak@gmail.com Tel: +201005337317 or through postal Address: Department of Engineering Mathematics and Physics, Faculty of Engineering, Alexandria University, Alexandria, 21544 -Egypt.

Atef A. Ata was born in Alexandria, Egypt in 1962 and received his BS.c. Degree with Honor in Mechanical Engineering from AlexandriaUniversity in Egypt in 1985. After his graduation he joined the same university as a Lecturer where he obtained his MS.c. Degree in Engineering Mathematics (Hydrodynamics) in 1990. In 1996 he obtained his Ph.D in Engineering Mathematics (Robotics) as a Joint-Venture between University of Miami, Florida, USA and Alexandria University in Egypt.

He joined Alexandria University again as Assistant Professor till 2001. Then he joined the Mechatronics Engineering Department, International Islamic University Malaysia as an Assistant Professor , Associate Professor (2004) and as a Head of Department (November 2005-June 2007). Currently he is a Professor of engineering mechanics at the Faculty of Engineering, Alexandria University, Egypt. Dr. Atef is a senior member of IACSIT as well as Egyptian Engineering Syndicate. He was also one of the Editorial Consultant Board for 2006-2008 for the International Journal of Advanced Robotic Systems, Austria. Currently he is one of the Editorial board of Mechanical Engineering Research, Canada and an Associate Editor of Alexandria Engineering Journal, Egypt hosted by Elsevier. His research interest includes Dynamic and Control of Flexible Manipulators, Trajectory Planning, Genetic Algorithms and Modeling and Simulation of Robotic Systems.

Author can be reached by: E-mail: atefata@gmail.com or through postal Address: Department of Engineering Mathematics and Physics, Faculty of Engineering, Alexandria University, Alexandria, 21544 -Egypt.