

High Precision Draw Bending of Asymmetric Channel Section with Restriction Dies and Axial Tension

Y. Okude, S. Sakaki, S. Yoshihara and B. J. MacDonald

Abstract—In recent years asymmetric cross section aluminum alloy stock has been finding increasing use in various industrial manufacturing areas such as general structures and automotive components. In these areas, components are generally required to have complex curved configuration and, as such, a bending process is required during manufacture. Undesirable deformation in bending processes such as flattening or wrinkling can easily occur when thin-walled sections are bent. Hence, a thorough understanding of the bending behavior of such sections is needed to prevent these undesirable deformations. In this study, the bending behavior of asymmetric channel section was examined using finite element analysis (FEA). Typical methods of preventing undesirable deformation, such as asymmetric laminated elastic mandrels were included in FEA model of draw bending. Additionally, axial tension was applied to prevent wrinkling. By utilizing the FE simulations effect of restriction dies and axial tension on undesirable deformation during the process was clarified.

Keywords—bending, draw bending, asymmetric channel section, restriction dies, axial tension, FEA

I. INTRODUCTION

EXTRUDED aluminum alloy sections have the advantages of light weight and a high bending rigidity. These sections are suitable for general structures with curved parts and automotive components. During manufacturing a bending process as a secondary process is usually required. During draw bending of the thin extruded sections, undesirable deformation problems such as flattening or wrinkling are often encountered. Flattening is characterized as unwanted cross-sectional deformation and wrinkling is generally caused by buckling. Channel sections are especially prone to undesirable deformation due to the open cross-section. The deformation of the tube is clearly influenced by its material properties, namely the plastic modulus C value and work-hardening exponent n value. Many studies have been carried out to clarify the effect

of these material properties on the deformation behavior using the finite element method (FEM). Specifically, finite element simulation has been shown to successfully predict undesirable deformation behavior in the draw bending process. For example, the positive effects of the additional axial tension and the presence of center rib were further clarified by FEA [1]. Li et al have proposed a finite element (FE) method for the evaluation of wrinkling limit diagrams in pipe bending [2]. The method described a calculated stress field that considered material anisotropy, the 3D strain field and different loading paths and took into account the boosting force. Thus, this method gave the wrinkling criterion which accurately reflects the true wrinkling mode. Kristoffer demonstrated a study which detailed a multi-stage forming operation with tube bending followed by tube hydroforming [3]. This study represented the importance of including the effects acquired from the bending and the pre-forming processes in the hydroforming simulation in order to obtain reliable simulation results. The effect of material constants on tube bending is required for further clarification. Murata et al have used the experimental and FE analysis to indicate that the work-hardening exponent n value did not affect for spring-back, thickness strain distribution and flatness ratio at the same bending radius of same tube dimension [4]. FE simulation of bending method with slight reduction in diameter was calculated to indicate the deformation behavior and the deformation mechanism in the thin-walled electric resistance welded steel (ERW) tube [5]-[6]. The results of the FEM simulation conformed well to the experimental results. It was clearly shown that when the mandrel is inserted into the work-piece it helps prevent flattening and wrinkling in the case of the square tubes [7]. An axial tensile force on the work-piece has also been successfully used to prevent the wrinkling at the compression flange and buckling during plug bending [8]. Studies of bending of channel sections have also been carried out to determine the working properties of these sections. For example, to provide the bending characteristic of channel sections, pure bending has been used [9]-[10]. Moreover, a model of a U-section was constructed to calculate the deformation behavior of the work-piece during stretch bending [11]. A new method of bending defined as rotary stretch bending was demonstrated to bend a hat section to improve the bending limit in draw bending [12]. Multi-axis bending was also carried out to determine the bending behavior of a channel section beam without undesirable deformation [13]. In addition, the bending of channel sections was demonstrated to clarify the working

Y. Okude is with the Engineering for Functional Material System, University of Yamanashi, Yamanashi, 4-3-11 Takeda Kofu-city, Japan (phone: +81-55-220-8438; fax: +81-55-220-8779; e-mail: g10df004@yamanashi.ac.jp).

S. Sakaki is with the Tokyo Metropolitan Institute of Technology, Tokyo, 6-6 Asahigaoka Hino-city, Japan (phone: +81-42-558-4198; fax: +81-42-558-419; e-mail: ssakaki@kind.ocn.ne.jp).

S. Yoshihara is with the Department of Mechanical System Engineering, University of Yamanashi, Yamanashi, 4-3-11 Takeda Kofu-city, Japan (phone: +81-55-220-8438; fax: +81-55-220-8779; e-mail: yoshihara@yamanashi.ac.jp).

B. J. MacDonald is with the School of Mechanical Engineering, Dublin City University, Dublin 9, Ireland (phone: +353-1-700 8046; fax: +353-1-700 5345; e-mail: bryan.macdonald@dcu.ie).

property during the bending process [14]. A floating mandrel which transferred with flow of work-piece and step rotary drum were suggested to bend asymmetric channel sections [15]. In the bending of asymmetric channel sections, methods which are typified by restriction dies or axial tension are generally suggested to prevent undesirable deformation. In these previous studies however, the effect of the method for the bending of asymmetric channel section on the undesirable deformation has not been completely elucidated because the relationship between the occurrence of the undesirable deformation and the stress state are complicated.

Therefore, it is necessary to determine the effect of the material properties under different working conditions in order to prevent undesirable deformation of the channel section. In this study, the objective is to clarify the deformation property by the applying the method to bending of asymmetric channel section. From the results of the FEA, the effect of the restriction dies and the axial tension on the deformation property of asymmetric channel sections was investigated.

II. FEA OF DRAW BENDING FOR CLARIFYING BASIC BENDING CHARACTERISTIC OF ASYMMETRIC CHANNEL SECTION

A. FEA model

The finite element analysis code LS-DYNA3D was used. The finite element models of extruded aluminum alloy (A6061S-O and A6061S-T6) channel sections tubes were constructed. Fig.1 shows a schematic of work-piece. Two elements were used in the thickness direction. Ten element divisions were used for both height and width directions. The work-pieces of channel sections were modeled using 7870 solid elements and consisted of 10920 nodes. Table I shows the material properties of the work-pieces. They were assumed to be made of an elasto-plastic material satisfying the n -th power strain hardening law with the constitutive equation

$$\sigma = C(\varepsilon_e + \bar{\varepsilon}_p)^n \quad (1)$$

where C is the plastic modulus, n the work-hardening exponent, ε_e the offset due to elastic strain and $\bar{\varepsilon}_p$ the effective plastic strain.

Fig.2 shows the simulation model of draw bending with square type mandrel in FEA. The bending radius is 150mm. The bending angle is 90 degrees. The bending roller was located at a distance of $4H_0$ from the bending point. In addition, bending moment was applied to the work-piece by this roller. The guide roller was positioned at a distance of $6H_0$ from the bending point.

B. Laminated elastic mandrel

The mandrel was inserted into the work-pieces to prevent undesirable deformation. Table II indicates the material properties of the laminated elastic mandrel. The mandrel is layered with 8 sheets of 66nylon plates and 2 sheets of phosphor bronze plates. The phosphor bronze plates are set on the exterior of the mandrel to protect the 66nylon plates from the wrinkling of folding. The clearance between the work-piece and the mandrel was regulated to within 0.2 mm in the directions of both the radius and the width of the work-piece.

The apex of the mandrel was set at a distance of $2H_0$ from the bending point to prevent the wrinkling and flattening. The web direction of the mandrel was constrained in order to prevent the protruding of the mandrel from the work-piece.

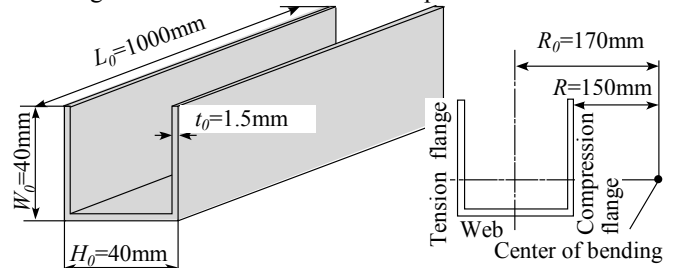

Fig. 1 Schematic of work-piece

TABLE I
 MATERIAL PROPERTIES OF WORK-PIECES

Material	Density ρ [kg/mm ³]	Modulus of elasticity E [GPa]	C value [MPa]	n value
A6061S-O	2.7×10^{-6}	68.9	204	0.22
A6061S-T6	2.7×10^{-3}	68.9	388	0.08

* $\sigma = C\varepsilon^n$

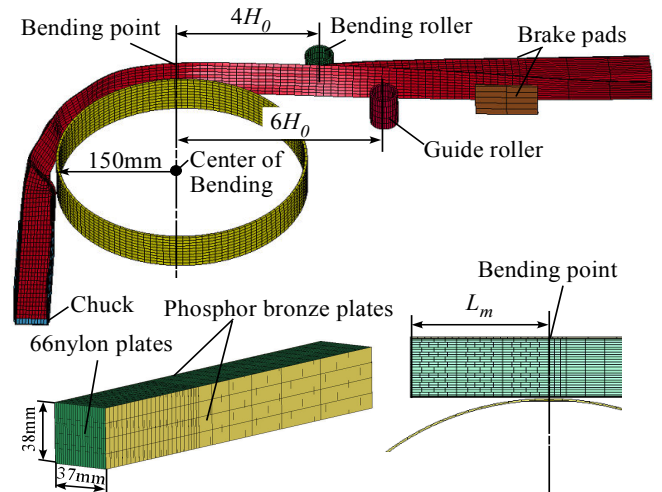

Fig. 2 FEA model of draw bending with square type mandrel

TABLE II
 MATERIAL PROPERTIES OF LAMINATED ELASTIC MANDREL

Material	Density ρ [kg/mm ³]	Modulus of elasticity E [GPa]
Phosphor bronze	8.8×10^{-6}	102
66nylon	1.14×10^{-6}	0.799

C. Bending behavior of asymmetric channel section

Fig. 3 shows the FEA results of the asymmetric channel section with the square type mandrel in the both materials A6061S-O and A6061S-T6. Flattening in the tension flange occurred, also the work-pieces were ejected by the mandrel caused by reaction force along the web direction. In the area of contact between the work-piece and the mandrel, torsion occurred on the work-piece caused by the restriction force in the web direction.

From these results, it is clear that flattening and torsion were not prevented by the square type mandrel alone. Therefore,

further methods of the preventing undesirable deformation were utilized in the following simulations.

III. METHODS OF PREVENTING UNDESIRABLE DEFORMATION FOR ASYMMETRIC CHANNEL SECTION

A. Restriction dies to prevent wrinkling or folding

Floating wiper die

The use of a wiper die which is able to constrain both the flanges and the web was suggested in order to prevent undesirable deformation in each direction. Fig.4 shows a schematic of the wiper die. The wiper die is located at the rear of bending point to prevent wrinkling or folding. The square tube passes through the inner cavity (40 mm × 40 mm) of the wiper die during the forming. Table III shows the conditions of the length of the wiper die (L_w).

Front wiper die

In the bending of asymmetric channel section, the wrinkling specifically occurred at the range between the chuck and a point bending angle of 0 degrees (bending start point). Therefore, the front wiper die was suggested to prevent the wrinkling at the range between the chuck and the bending start point. Additionally, the front wiper die has the role to prevent the flattening in the tension flange.

B. Restriction dies to prevent torsion

Plates for preventing torsion

Plates were suggested to prevent torsion which is introduced in the non-working area. These plates were set on the range between the end of the wiper die and the guide roller to guide the work-piece into the wiper die. In addition, a bending moment was applied on the work-piece by a plate on the tension flange in space of the bending roller.

Back plate

The back plate at the web was devised to prevent torsion on the forming area. The angle from bending point to the apex of the back plate was determined as 35 degrees so as not to impinge the trajectory of the chuck during the bending process.

C. Asymmetric type mandrel

Fig.5 shows the schematic of reaction force on each of the mandrels. In the case of the bending with square type mandrel, the reaction force concentrates at the apex of the mandrel. Therefore, an asymmetric type mandrel was used in the draw bending of asymmetric channel sections to reduce reaction force. The effect of the L_m (length of mandrel) on wrinkling was investigated to clarify the relationship between wrinkling and the wiper die. L_m was defined as the length between the bending point and the apex of the compression flange in the asymmetric type mandrel. Table IV shows the conditions of the length of the mandrel (L_m).

D. Axial tension

Fig.6 shows the FEA model of the draw bending with the restriction dies. Axial tension is applied by sandwiching between the work-piece and both brake pads. The axial tension ratio R_{at} was calculated from the axial tension and the tensile strength as follows.

$$R_{at} = \frac{T}{\sigma_B \times A} \times 100(\%) \quad (2)$$

where T is the axial tension, σ_B the tensile strength and A the cross section area of work-piece. Table V shows the relationship between the axial tension and the axial tension ratio.

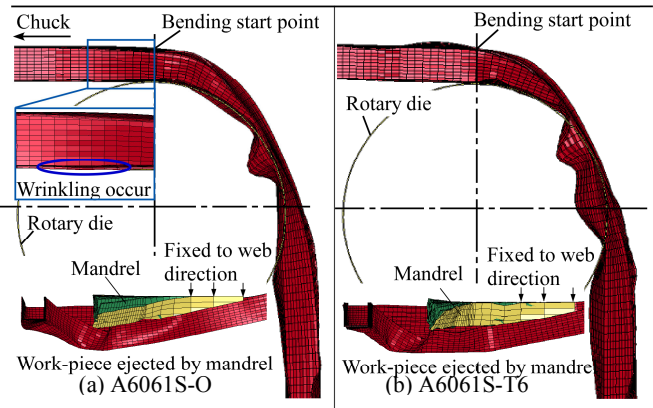

Fig. 3 FEA results of asymmetric channel section with mandrel in both materials A6061S-O and A6061S-T6

TABLE III
CONDITIONS OF LENGTH OF WIPER DIE

L_w [mm]	20	40	60	80	100
L_w/H_0	0.5	1.0	1.5	2.0	2.5

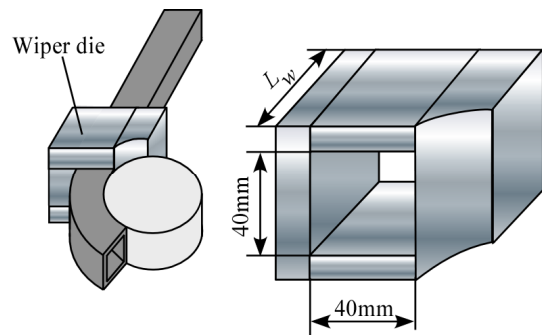

Fig. 4 Schematic of floating type wiper die

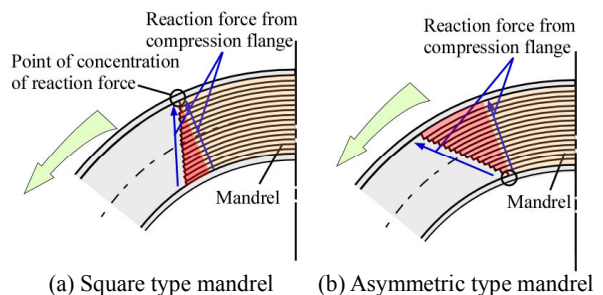

Fig. 5 Schematic of reaction force on each mandrels

IV. DEFORMATION BEHAVIOR OF ASYMMETRIC CHANNEL SECTION WITH RESTRICTION DIES AND AXIAL TENSION

A. Evaluation methods

After the bending process, a method was required to evaluate undesirable deformation occurring in the forming area defined as the range of bending angle from 0 to 90 degrees. Fig.7 shows an A-A' cross section. Table VI indicates the parameters used to evaluate undesirable deformation. The inner distance between the compression and the tension flanges was defined as H_i . The location of A-A' was selected at the point of minimum H_i , thus corresponding to the cross section that has the maximum amount of undesirable deformation. The parameters measured at A-A' were used to clarify the effect of the various methods employed for preventing undesirable deformation.

B. Bending characteristic with mandrel and floating wiper die

Relationship between length of floating wiper die and wrinkling at area without bending strain

Fig.8 shows the FEA model and the outer shape of the compression flange (A6061S-O). There is clear evidence of wrinkling in the area without bending strain (wrinkling I and II), and the inflow of the work-piece into the working area was inhibited by the wrinkling. It is clearly important to prevent wrinkling in this area in order to improve the quality of the product. The depth W_{nd} and the pitch P_{nw} of wrinkling were measured to clarify the effect of the floating wiper die. Table VII shows the relationship between the length of floating wiper die and wrinkling in the unbent section in the A6061S-O and A6061S-T6. In the condition of $L_w=100$ mm, the work-piece smoothly inflow to the axial direction of the work-piece but the tensile force decreased. Since the analysis at $L_w=100$ mm stopped by increase of the wrinkling at forming area.

Effect of material properties on behavior of wrinkling at area without bending strain

Two wrinkles of the different wavelength (wrinkling I and II) occurred in the unbent section under the $L_w \leq 40$ mm in both materials as shown in Fig.8. Wrinkling behavior was different, however, between A6061S-O and A6061S-T6 when $L_w=60$ mm. These results indicated that wrinkling behavior was significantly affected by the material properties.

The W_{nd} and the P_{nw} totally decreased as the L_w increased. From these results, the $L_w=100$ mm was selected as the basic condition of the floating wiper die to prevent wrinkling in the unbent section of the work-piece.

TABLE IV
 CONDITIONS OF LENGTH OF MANDREL

L_m [mm]	120	160	200	240
L_m/H_0	3.0	4.0	5.0	6.0
Filling rate of mandrel for length at area passed through bending point [%]	51	68	85	102

TABLE V

RELATIONSHIP BETWEEN AXIAL TENSION AND AXIAL TENSION RATIO			
Material	A6061S-O	A6061S-T6	
Tensile strength σ_B [MPa]	147	296	
Cross section A [mm ²]	204	204	
Axial tension ratio R_{at} [%]	Value of axial tension [kN]		
	0	0	0
	5	1.3	2.6
	10	2.6	5.2
15	3.9	7.8	

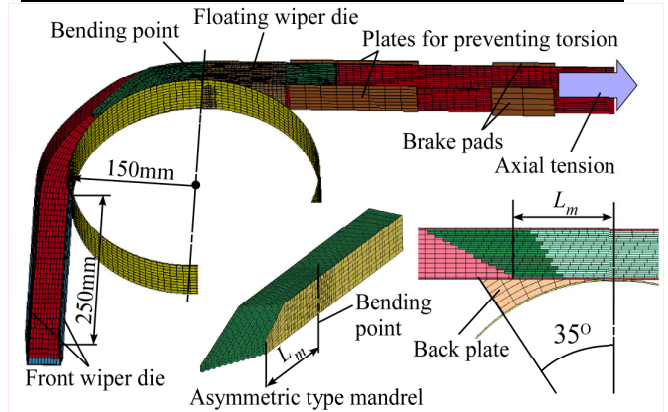

Fig. 6 FEA model of draw bending with restriction dies

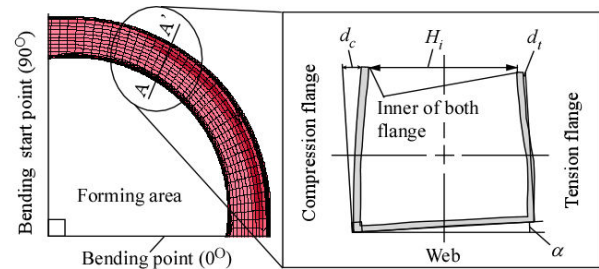

Fig. 7 A-A' cross section

TABLE VI
 PARAMETERS USED TO EVALUATE UNDESIRABLE DEFORMATION

H_i	Inner distance between compression and tension flanges
d_t	Flattening of tension flange
d_c	Flattening of compression flange
α	Torsion angle

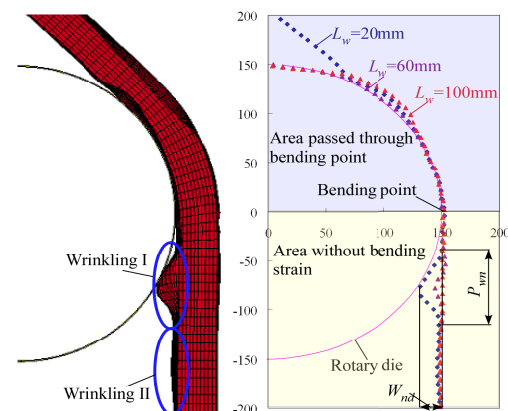

Fig. 8 FEA model and outer shape of compression flange (A6061S-O)

C. Effect of restriction dies on bending behavior (square type mandrel)

Fig.9 shows the FEA predicted effective plastic strain distribution with restriction dies using A6061S-O and a bending radius of 150 mm, and bending angle of 90 degrees. Four conditions (condition I: with mandrel and floating wiper die. condition II: with mandrel, floating wiper die and plates for preventing torsion. condition III: with mandrel, floating wiper die, plates for preventing torsion and back plate. condition IV: with mandrel, floating wiper die, plates for preventing torsion, back plate and front wiper die) were modeled and the values of A-A' cross section were compared with each results.

Effect of plates for preventing torsion on the bending behavior at the area which has passed through bending point

By applying the plates for preventing torsion, the torsion at the area without bending strain was prevented. Furthermore, wrinkling which occurred at the area without bending strain was completely prevented by the constraining effect on the compression flange. It was confirmed, however, that undesirable deformation was not particularly affected by the plates for preventing torsion.

Effect of back plate on bending behavior at area passed bending point

The back plate was applied at the web of forming area to prevent torsion of the section. Wrinkling and flattening at the forming area decreased by the tensile force which occurred by the frictional force between the back plate and the work-piece. Additionally, torsion decreased at area passed through bending point. On the other hand, the d_t and the α of A-A' cross section increased as undesirable deformation on the compression flange decreased. The angle of the A-A' cross section was located at the vicinity of bending angle 0 degrees.

Effect of front wiper die on bending behavior at area passed through bending point

To prevent the undesirable deformation which occurred at a point of bending angle of 0 degrees, the front wiper die was applied. Wrinkling, flattening and torsion decreased by using the front wiper die. Torsion which occurred at a point bending angle 0 degrees was especially decreased by the function of the feature to maintain the tension flange. In the condition of the bending analysis with front wiper die, the angle of the A-A' cross section was glided from the vicinity of bending angle 0 to

45 degrees.

D. Effect of asymmetric type mandrel on bending Behavior

Effect of the mandrel type on the bending behavior at the forming area

Fig.10 shows the FEA predicted effective plastic strain distribution with the asymmetric type mandrel using A6061S-O, a bending radius of 150mm, and a bending angle of 90 degrees. Both torsion at the A-A' cross section and flattening on the tension flange during bending process were decreased by using the asymmetric type mandrel. The value of d_t reduced from 7.1 mm to 3.8 mm in comparison with the results obtained using the square type mandrel. The reduction of torsion was caused by the decrease in flattening on the tensile flange. The force for inner direction of cross section decreased by using the asymmetric type mandrel. Additionally, the reaction force at the apex of the mandrel was compared with the asymmetric type mandrel and the square type mandrel. The reaction force reduced to one-tenth in the case of the asymmetric type mandrel.

TABLE VII
RELATIONSHIP BETWEEN LENGTH OF FLOATING WIPER DIE AND WRINKLING ON AREA WITHOUT BENDING STRAIN IN A6061S-O AND A6061S-T6

Material	A6061S-O					A6061S-T6				
L_w [mm]	20	40	60	80	100	20	40	60	80	100
(L_w/H_0)	(0.5)	(1.0)	(1.5)	(2.0)	(2.5)	(0.5)	(1.0)	(1.5)	(2.0)	(2.5)
W_{nat} [mm]	17.2*	14.1	6	5.9	1.4	16.4*	7.2*	7.4	4.1	1.5*
P_{wnt} [mm]	101.8*	51.2	49.6	122.2	105.5	104.4*	52.1*	121.4	131.7	123.0*
W_{natl} [mm]	2.9*	8.2*	1.7	0	0	5.0*	5.1*	0	0	0
P_{wntll} [mm]	114.4*	122.2*	131.9*0	0	0	131.2*	166.2*0	0	0	0

*The maximum value when the analyses stopped.

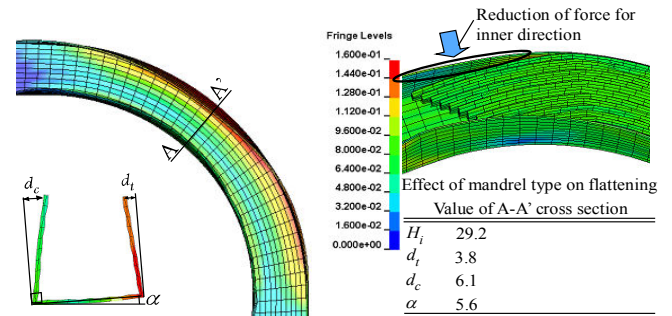

Fig. 10 Effective plastic strain distribution of FEA result with asymmetric type mandrel

Condition	Condition I	Condition II	Condition III	Condition IV
Results				
H_i [mm]	10.2	8.6	3.6	19.5
d_t [mm]	8.1	8.5	9.3	7.1
d_c [mm]	20.3	22.1	23.1	12.4
α [°]	24.2	24.5	24.6	14.3

Fig. 9 Effective plastic strain distribution of FEA result with restriction dies in the conditions of A6061S-O the bending radius 150mm, the bending angle 90°, mandrel length 80mm, length of floating wiper die 100mm

Relationship between length of asymmetric type mandrel and bending behavior at the forming area

Fig.11 shows the relationship between L_m and the relevant parameters of the A-A' cross section. The depth of undesirable deformation decreased as L_m increased. The torsion angle α was significantly affected by the length of the mandrel.

E. Effect of axial tension on reducing wrinkling

Fig.12 shows the compression stress-bending angle diagram obtained by FEA and the measurement point of the stress. The compression stress was measured at the element that passed through the bending point. The compression stress decreased with application of axial tension. However, wrinkling, which caused flattening occurred at a point near a bending angle of 0 degrees under both conditions. Table VIII shows the effect of axial tension on the A-A' cross section (A6061S-O and A6061S-T6). In both materials, wrinkling was prevented by applying axial tension of $R_{at}=15\%$.

V.CONCLUSION

Various restriction dies for the bending of channel sections were suggested in order to help prevent undesirable deformation. The results from the FE analyses of draw bending with the restriction dies and axial tension suggest that:

1) The restriction dies and axial tension were effective for preventing undesirable deformation which occurred during bending of the asymmetric type work-piece. Therefore, it is possibility to bend sections which have complex shapes or low formability (i.e. poor material properties) by introducing these methods.

2) It is necessary to consider the fracture on the work-piece since the possibility of the fracture is increased by applying axial tension. Future work will concentrate on this.

ACKNOWLEDGMENT

This work was supported by Japan Aluminum Association Inc. in Japan.

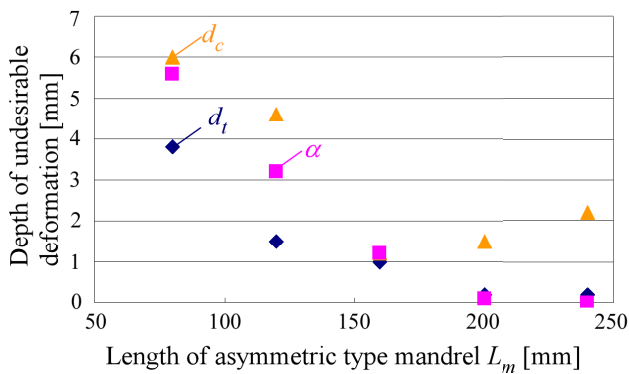

Fig. 11 Relationship between L_m and value of A-A' cross section

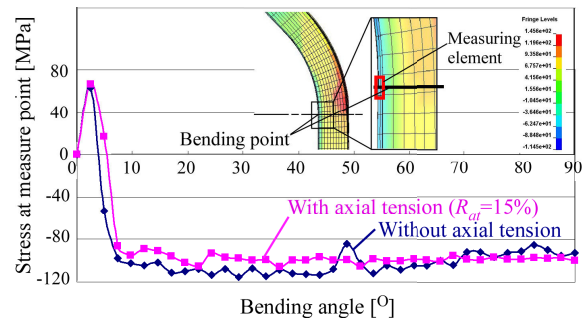

Fig. 12 Compression stress-bending angle diagram obtained by

TABLE VIII
 EFFECT OF AXIAL TENSION ON A-A' CROSS SECTION

Material and condition	A6061S-O, $L_m=200$ mm, $R_{at}=15\%$	A6061S-T6, $L_m=200$ mm, $R_{at}=15\%$
H_t [mm]	36.0	34.4
d_i [mm]	0.5	0.6
d_c [mm]	0.5	2.0
α [°]	0	0

REFERENCES

- [1] N. Utsumi, "Countermeasures against undesirable phenomena in the draw-bending process for extruded square tubes," *J. Mater. Process. Technol.*, vol. 123, pp. 264–269, Apr. 2002.
- [2] H. Li, "A new method to accurately obtain wrinkling limit diagram in NC bending process of thin-walled tube with large diameter under different loading paths," *J. Mater. Process. Technol.*, vol. 177, pp. 192–196, July 2006.
- [3] K. Trana, "Finite element simulation of the tube hydroforming process—bending, preforming and hydroforming," *J. Mater. Process. Technol.*, vol. 127, pp. 401–408, Oct. 2002.
- [4] M. Murata, "Effect of hardening exponent on tube bending," *J. Mater. Process. Technol.*, vol. 201, pp. 189–192, May 2008.
- [5] O. Sonobe, "Deformation mechanism of thin-walled tubes in bending method with slight reduction in diameter," *J. of the JSTP*, vol. 52, pp. 720–725, June 2011 (in Japanese).
- [6] O. Sonobe, "Deformation behavior of thin-walled ERW tubes in bending method with slight reduction in diameter and FEM simulation," *J. of the JSTP*, vol. 52, pp. 715–719, June 2011 (in Japanese).
- [7] H. Suzuki, "Bending of circular tube with a drawing die," *The Japan society of mechanical engineering*, vol. 54, pp. 1933–1937, Aug. 1988 (in Japanese).
- [8] S. Maki, "Addition of pulling force to pipe bending method using a floating expanding plug," *J. of the JSTP*, vol. 42, pp. 129–133, Apr. 2000 (in Japanese).
- [9] M.M. Pastor, "Open cross-section beams under pure bending. I. Experimental investigations," *Thin-Walled Structures*, vol. 46, pp. 476–478, May 2008.
- [10] M.M. Pastor, "Open cross-section beams under pure bending II. Finite element simulation," *Thin-Walled Structures*, vol. 47, pp. 514–521, May 2009.
- [11] A.A. EL-DOMIATY, "Open cross-section beams under pure bending II. Finite element simulation," *Int. J. Math. Tools Manufact.*, vol. 38, pp. 75–95, Feb. 1998.
- [12] Y. Liu, "Bending collapse of thin-walled circular tubes and computational application," *Thin-Walled Structures*, vol. 46, pp. 442–450, Apr. 2008.
- [13] Z. YU, "Numerical analysis of dimension precision of U-shaped aluminium profile rotary stretch bending," *Transactions of Nonferrous Metals Society of China*, vol. 17, pp. 581–585, June 2007.
- [14] I. Ochiai, "A study of V-bending of thin channels," *J. of the JSTP*, vol. 10, pp. 591–597, Aug. 1969 (in Japanese).
- [15] I. Ochiai, "Improvement of bending accuracy on draw bending of channel section," *2002 Jpn. Spring conf. for the Technol. of plasticity*, pp. 363–364, (in Japanese).