

Optimization of GAMM Francis Turbine Runner

Sh. Derakhshan, A. Mostafavi

Abstract—Nowadays, the challenge in hydraulic turbine design is the multi-objective design of turbine runner to reach higher efficiency. The hydraulic performance of a turbine is strictly depends on runner blades shape. The present paper focuses on the application of the multi-objective optimization algorithm to the design of a small Francis turbine runner. The optimization exercise focuses on the efficiency improvement at the best efficiency operating point (BEP) of the GAMM Francis turbine. A global optimization method based on artificial neural networks (ANN) and genetic algorithms (GA) coupled by 3D Navier-Stokes flow solver has been used to improve the performance of an initial geometry of a Francis runner. The results show the good ability of optimization algorithm and the final geometry has better efficiency with initial geometry. The goal was to optimize the geometry of the blades of GAMM turbine runner which leads to maximum total efficiency by changing the design parameters of camber line in at least 5 sections of a blade. The efficiency of the optimized geometry is improved from 90.7% to 92.5%. Finally, design parameters and the way of selection have been considered and discussed.

Keywords—Francis Turbine, Runner, Optimization, CFD

I. INTRODUCTION

AERO/HYDRO dynamic shape optimization is one of the most popular issues in aero/hydrodynamic design procedure in recent decades. Optimization algorithms are widely used in turbomachinery design process to achieve higher performance of the machines. In this research, optimization of blades shape of a reference Francis turbine runner namely GAMM has been considered to maximize its total efficiency at the best efficiency point of the turbine via a numerical optimization package including parameterization, CFD, artificial neural networks and genetic algorithms modules. The goal was to optimize the geometry of the blades of GAMM turbine runner which leads to maximum total efficiency by changing the design parameters of camber line in at least 5 sections of a blade. The methodology relies on the interaction between genetic algorithm, artificial neural network, database and user generated objective functions and constraints. The optimization is coupled to the FINETM/Turbo environment of NUMECA as the solver. The efficiency of the initial geometry was improved by various objective functions and optimized geometry was obtained. Finally the best objective function which was a combination of head and torque was selected. It caused increase in the desired efficiency which has been discussed in detail in the paper. The efficiency of the optimized geometry is improved from 90.7% to 92.5% by a robust optimization method.

II. BACKGROUND

Turbomachinery blades design is a complex task involving many different objectives and constraints coming from various disciplines.

Shahram Derakhshan Houreh is with Iran University of Science and Technology, Iran, e-mail(shderakhshan@iust.ac.ir)

Further improvement of this design cycle is probably one of the main challenges of the next decade in the turbomachinery community. Major improvements are expected in terms of reduced design time, reduced engineering time, better performance and increased design complexity. This challenge can only be tackled by selecting and further developing general and efficient design algorithms integrated into software dedicated to this specific design task [1].

The optimization problems associated to turbomachinery design often involve many constraints and large sets of parameters, which in general leads to objective functions presenting many extremes. It is well known that optimization methods based on gradients techniques are efficient in terms of convergence rate, but do not guarantee to produce the global optimum [2]. On the other hand, genetic algorithms offer the advantage of enhancing the probability of reaching the global optimum, but may require thousands of iterations [3]. Their coupling with a three-dimensional Navier-Stokes solver cannot be considered under the framework of an industrial design process. The major idea of the optimization system contained in FINETM/Design3D is that the evaluation of the successive designs is performed using an artificial neural network instead of a flow solver, which permits to use the genetic algorithms in an efficient way. The accuracy of the optimization depends on the knowledge of the artificial neural network, which is fed by design examples stored in a database.

Demeulenaere et al. [4] used multipoint optimization method to have performance improvements over a wide range of operating conditions in the case of an industrial pump. Significant improvements have been obtained in terms of efficiency, pressure rise and NPSH. Kueny and Alanga have done optimal design of a Francis turbine distributor to obtain new geometry with better efficiency and performance compared to the initial design [5]. Kueny et al. [6] have used an optimal design technique based on artificial neural network and genetic algorithm to improve the design of a small hydraulic axial turbine.

The core of the design system is a database containing the results of all Navier-stokes computations performed during the previous and present design processes. For each sample the geometrical parameters and the fluid properties and flow-field boundary conditions used by the Navier-Stokes solver which as an inputs and the hydrodynamic performance characterized by the efficiency, total pressure rise and other quantities as an outputs depending on the configuration.

An iterative procedure is used, that the first step is a "learning process" is used to build the artificial neural network on basis of all the examples stored in the database. Learning process is performed by back-propagation of the errors. After this process, the artificial neural network is able to predict the aerodynamic performance of blade geometries under given boundary conditions that are not inside the database.

The next step consists of finding a new design using an optimization procedure formed by a genetic algorithm, the aerodynamic performance being evaluated by means of the trained artificial neural network instead of Navier-Stokes

solver. The global blade performance is evaluated through an objective function, which translates all the user imposed constraints into a single number. The result of this optimization is a point in the design space that is expected to be the optimum of the real problem. The new geometry provided by the optimization is then evaluated by means of the 3D Navier-Stokes flow solver and this new sample is added to the database. The comparison of the obtained performance with the one predicted by the artificial neural network permits to evaluate the accuracy of the network. The obtained performance is also compared to the imposed one. If the target performance has not been achieved other iteration is started, and the same process is repeated until the optimum blade is obtained (Fig. 1). Each design iteration starts with the artificial neural network learning. As the design proceeds, the database grows, leading to improvements of the approximate relation and therefore to a better localization of the real optimum [4].

III. DESCRIPTION OF THE GAMM FRANCIS TURBINE

The test model corresponds to a Francis turbine of medium/high specific speed. It was designed at IMHEF for experimental research study in the hydraulic laboratory. The model was used as a test case in the 1989 GAMM workshop, where all the geometrical information, including stay and guide vanes, runner and draft tube, and the best efficiency measurements were available. The runner is also used as a test case in the annual ERCOFTAC Seminar and Workshop on Turbomachinery flow Predictions. The distributor CONSISTS of 24 stay vanes and 24 guide vanes. The runner has 13 blades and its external diameter is 0.4m, so the reference radius is 0.2m. The runner angular velocity and flow rate of this turbine on best operating condition were 500 rpm and 0.372 m³/s with guide vanes opening angle $\alpha=25^\circ$. The draft tube is simple, without any inner pillar. In Fig. 2, a schematic view of the GAMM Francis turbine meridian section has been presented [7].

IV. GEOMETRY PARAMETERIZATION

The geometry parameterization is a critical element in the success of any shape optimization method. Ideally, the parameterization of the geometry should be able to generate a large variety of physically realistic shapes with as few design variables as possible. Turbomachinery designers are accustomed to work with two-dimensional sections that are then stacked to the three-dimensional blade geometry. One method in blade construction defines a camber line and adds thickness distributions to obtain the suction and the pressure sides. The advantage of this method is that the blade thickness can be easily maintained during the optimization, by freezing the associated parameters. Endwalls can be parameterized by making use of Bezier or B-spline curves.

In this paper, the parametric model that has been adopted in AutobladeTM consists of 5 sections at hub, shroud and 3 sections between hub and shroud (Fig. 3), defined by a camber line and symmetric thickness distributions. Each camber line is a B-spline curve which was defined with 5 parameters (Fig. 4.a). Bezier curve with 5 parameters was used to represent the symmetric blade thickness at each

section that they were fixed via optimization process (Fig. 4.b).

The meridional location of each leading and trailing edges traces were imposed using a B-spline with 5 parameters which parameters were fixed via optimization process.

The tangential location law for the leading edge was defined using a lean law B-spline curve with 5 parameters. The meridional location of each hub and shroud endwall was defined by B-spline curve with 8 parameters which parameters were fixed via optimization process.

Finally, in optimization process, we allowed only variation of cord lines and leading edge stacking curve. Therefore the number of design parameters were limited to 30 (5 control points on each section and 5 control point for tangential law).

V. 3D FLOW SIMULATION

FINETM/Turbo developed by Numeca, is integrated software based on finite volume discretization for multi-block structured grids. To simulate the turbulent quantities with also a good rate of convergence the Spalart-Allmaras model was preferred (with turbulent viscosity, $\mu_t = 1.1e^{-6}$). The flow conditions for each calculus are imposed at boundaries related to Mass Flow Rate flow angles at inlet and Averaged Static Pressure at the outlet. The multi-block structured grids by O4H topology on the blades have been prepared by AutoGrid5TM developed by Numeca. The mesh template file must be defined to be as robust as possible with respect to the blade geometry modification.

For the near wall treatment, the first cell widths were assumed to be 0.1, 0.1 and 0.01 millimeter respectively for stay vanes, guide vanes and runner blades by assuming $y^+ = 3.0$.

To confirm the grid independency of the present simulations, three grid sizes (340527, 1042131 and 5547915 grid points) for initial turbine included of stay vanes, guide vanes, runner blades and draft tube were used. The computed efficiencies were 90.3%, 90.7% and 90.7% respectively, so medium grid level was selected. The error of the maximum efficiency calculated by present numerical method is less than 0.22% in comparison with the experimental measurement [8]. A blade to blade mesh view at section 4 of an initial runner blade has been shown in Fig. 5. As a convergence criterion, the computations were continued until the global residual decreased to less than 10^{-6} for discretized equations.

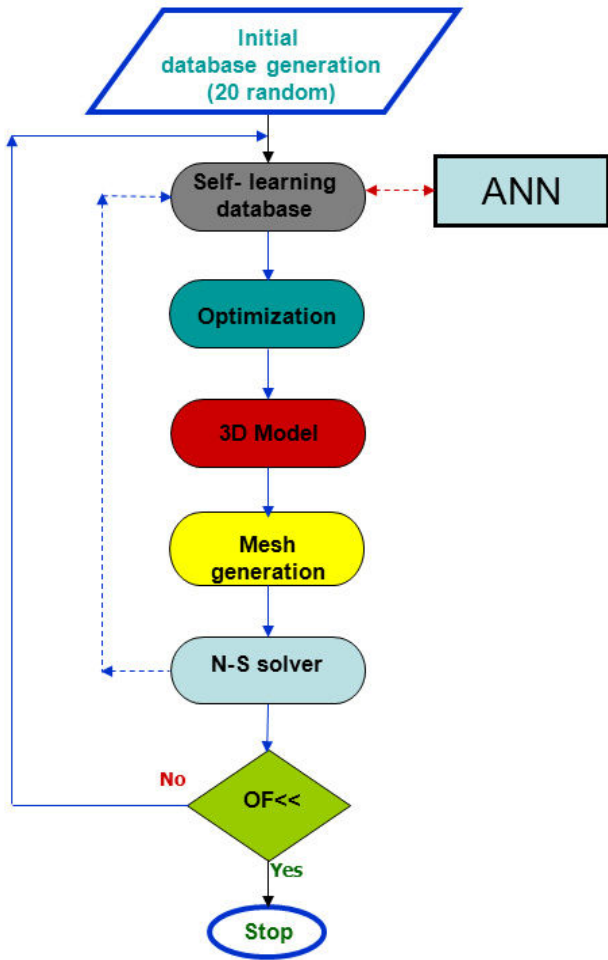

Fig. 1 Schematic view of optimization technique

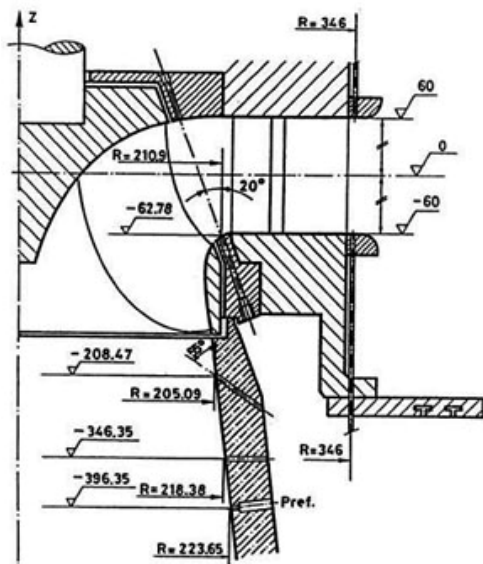

Fig. 2 Geometrical information of GAMM runner turbine [7]

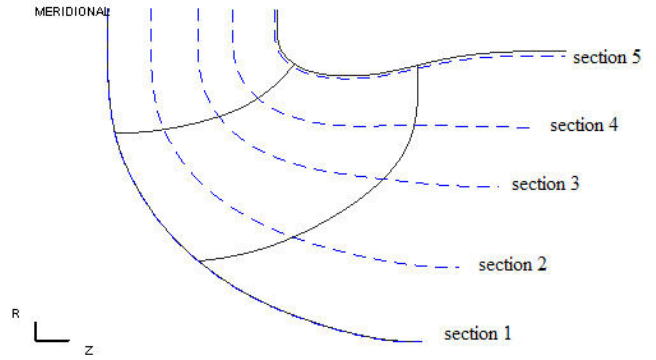

Fig. 3 Geometrical information of GAMM runner turbine

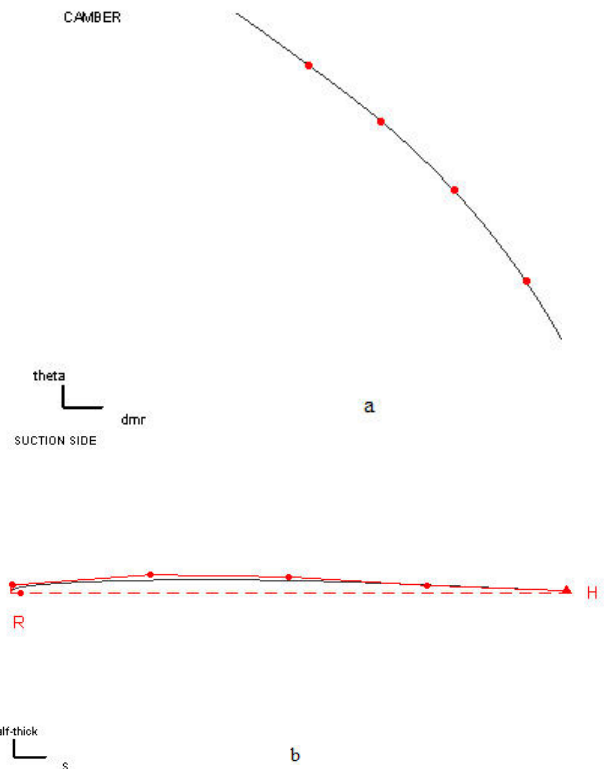

Fig. 4 a) B-spline curve with 5 parameters for each section, b) Bezier curve with 5 parameters for thickness distribution at each section

We also keep unchanged existing stay vane, guide vane and draft tube. Thus we separate the runner from other parts of turbine for optimization process. The associated computational domain has been shown in Fig. 5.

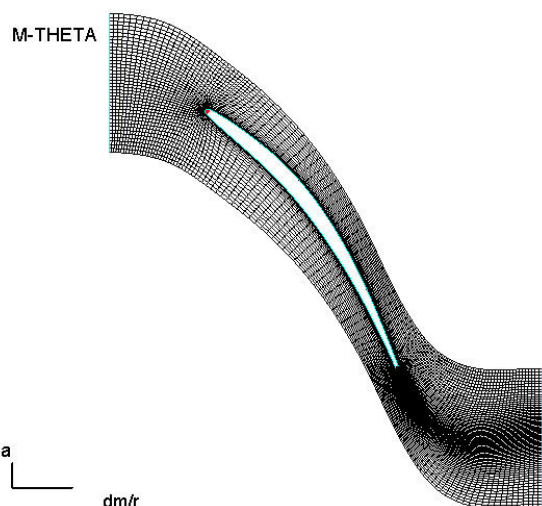

Fig. 5 Blade to blade mesh view at section 4 of an initial runner blade

VI. OPTIMIZATION

The multi-objective optimization was based on constant operating point. A database of 90 geometries has first been generated, the 30 geometrical parameters being varied in a random way. The optimization objective has imposed to the operating point to increase the efficiency in constant total pressure difference. In the beginning, the objective function has been considered as a combination of head and efficiency terms. This objective function is described as follows:

$$OF = m \left(\frac{E_t - E}{E_t} \right)^2 + n \left(\frac{\Delta P_i - \Delta P}{\Delta P_i} \right)^2 \quad (1)$$

Where $E_t = 1.0$ is the target efficiency and $\Delta P_i = -54000$ Pa is the initial total pressure difference. Optimization results with this objective function has been shown in Table I with various $K_e = \frac{m}{n}$ parameters

After that the objective function has been considered as a combination of torque and total pressure difference terms. This objective function is shown in the following.

$$OF = m \left(\frac{T_i - T}{T_i} \right)^2 + n \left(\frac{\Delta P_i - \Delta P}{\Delta P_i} \right)^2 \quad (2)$$

Where: $T_i = 420$ N.m is the target torque and $\Delta P_i = -54000$ Pa is the initial total pressure difference.

Optimization results with this objective function are shown in Table I with various $K_t = \frac{m}{n}$ parameters. The results of

optimization with this kind of objective function have been shown in Table II. With regard to Tables I and II, the objective function which is a combination of total pressure difference and torque terms with the value of $K_t=0.1$ is the best and selected as the desired objective function.

TABLE I
CFD RESULTS FOR OBJECTIVE FUNCTIONS WHICH ARE A COMBINATION OF EFFICIENCY AND HEAD TERMS

	Efficiency (%)	Total pressure difference (Pa)	Torque (N.m)	Minimum of static pressure (Pa)
Initial turbine	90.7	59900	386	62282
$K_e=1000$	91.7 (+1.1%)	61650 (+2.92%)	401 (+3.88%)	70960 (+13.9%)
$K_e=100$	91.6 (+0.99%)	60980 (+1.8%)	396 (+2.59%)	71057 (+14%)
$K_e=10$	91.6 (+0.99%)	60360 (+0.76%)	392 (+1.55%)	69717 (+11.9%)
$K_e=0.1$	91.5 (+0.88%)	60210 (+0.51%)	391 (+1.29%)	67704 (+8.7%)

TABLE II
CFD RESULTS FOR OBJECTIVE FUNCTIONS WHICH ARE A COMBINATION OF TORQUE AND HEAD TERMS

	Efficiency (%)	Total pressure difference (Pa)	Torque (N.m)	Minimum of static pressure (Pa)
Initial turbine	90.7	59900	386	62282
$K_t=10$	91 (+0.33%)	68550 (+14.44%)	443 (+14.7%)	66799 (+7.2%)
$K_t=0.1$	92.5 (+1.98%)	60810 (+1.51%)	399 (+3.36%)	70922 (+13.8%)
$K_t=0.01$	91.2 (+0.55%)	60390 (+0.81%)	391 (+1.29%)	69707 (+11.9%)
$K_t=0.001$	91.1 (+0.44%)	60330 (+0.71%)	390 (+1.03%)	68180 (+9.4%)

VII. RESULTS

The convergence histories of the optimization procedure have been shown in Fig. 6. One can be observed that the error between the artificial neural network predictions and the CFD results decrease, by iteration increasing and both of curves converges after some 30 iterations.

The approximated time required for one design iteration has been presented in Table III. The corresponding required computational time was 25 hours for optimization process with Intel Core i5, 2.4 GHz and 3GB of RAM memory.

For improving hydraulic efficiency in constant design point, the total pressure difference was added as a state constraint by penalty in the objective function.

As it has been shown in Tables I and II, by increasing K_e and K_t parameters, the difference to the design point has also been increased. Because when these parameters have been increased, the effect of the applied restriction by the head penalty for limiting the optimization to the constant design point has been decreased.

The turbine hydraulic efficiency is defined as:

$$\eta = \frac{T \cdot \omega}{\Delta p \cdot Q} \quad (3)$$

Where T (N.m) is the axial torque from the fluid to the runner, ω (rad/s) is the rotational speed of the turbine, Δp (Pa) is the

total pressure difference and Q (m^3/s) is the volumetric flow rate in the turbine. In Eq. (3) increasing the torque improves efficiency in constant Q and Δp .

For increasing efficiency by the objective function which is a combination of the total pressure difference and efficiency terms, the torque increasing has been restricted by the applied restriction for the head as Δp_i penalty in Eq. (2).

But in the optimization of the objective function which is a combination of the total pressure difference and torque terms, just one pressure difference restriction has been applied in the head penalty.

Finally, obtained geometry by the optimization with the objective function which is a combination of total pressure difference and torque terms with the value of $K_r=0.1$ is selected as the desired optimized runner. We can see that in Table II, the efficiency has been increased 1.98% by only increasing of 1.51% of the total pressure difference. Also we can see the increasing the minimum static pressure in the runner outlet (13.8%) that it means the geometry has been improved also in point of cavitation phenomena.

According to incomplete sensitivities theory, when the objective function is in term of aero/hydrodynamic force coefficients, the objective function is more sensitive to the geometry changes than state changes. It means when we define the objective function including torque we can expect more improved objective function. More detail can be found in [9, 10]. Therefore the torque in constant head is better objective function than the efficiency for improving the machine efficiency.

TABLE III
TIME REQUIRED FOR ONE DESIGN ITERATION

Step	Time(minutes)
ANN training	5
Optimization by GA	4
Mesh generation	4
CFD	32
One design iteration	45

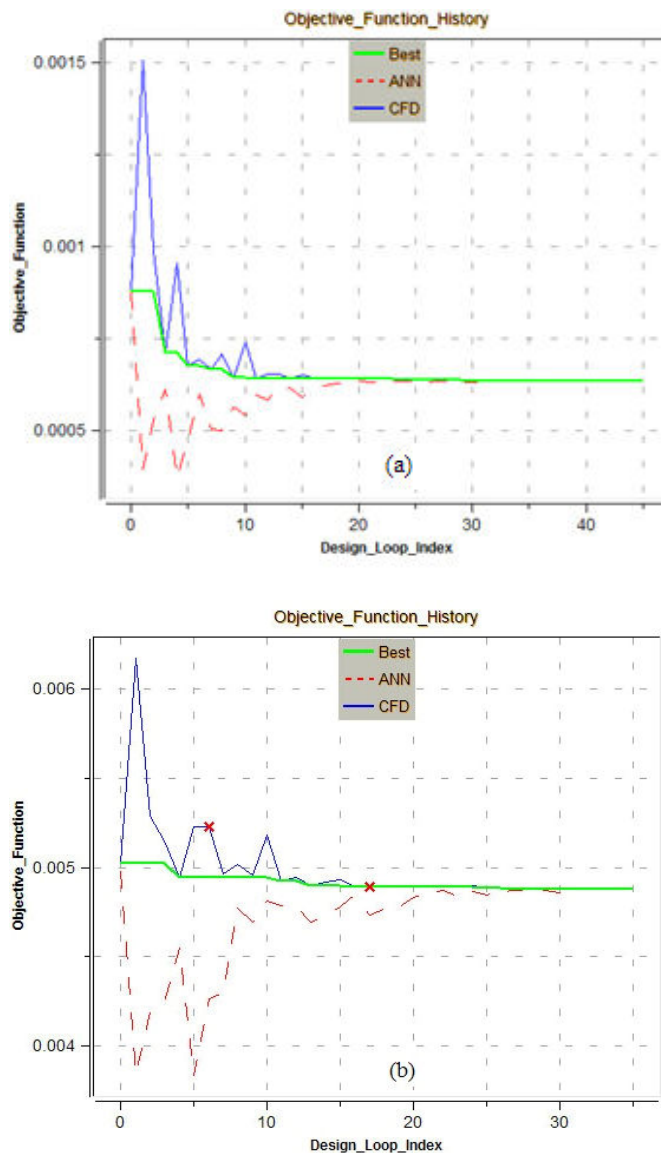

Fig. 6 Evolution of objective function during optimization a) with the objective function which is a combination of head and efficiency terms with the value of $K_e=0.1$ b) with the objective function which is a combination of head and torque terms with the value of $K_r=0.1$

The associated geometrical changes have been shown in Fig. 7. We can observe very significant modifications of the camber lines at section 3 and section 5.

Two multi-objectives were grouped into one single objective function, built as the summation of two objectives. The efficiency of the optimized geometry was improved from 90.7% to 92.5%. Inlet blade angle has been decreased in sections 3 and 5.

3D views of the initial and optimized blades have been shown in Fig. 8. Fig. 9 presents the static pressure distributions along the initial and optimized turbine.

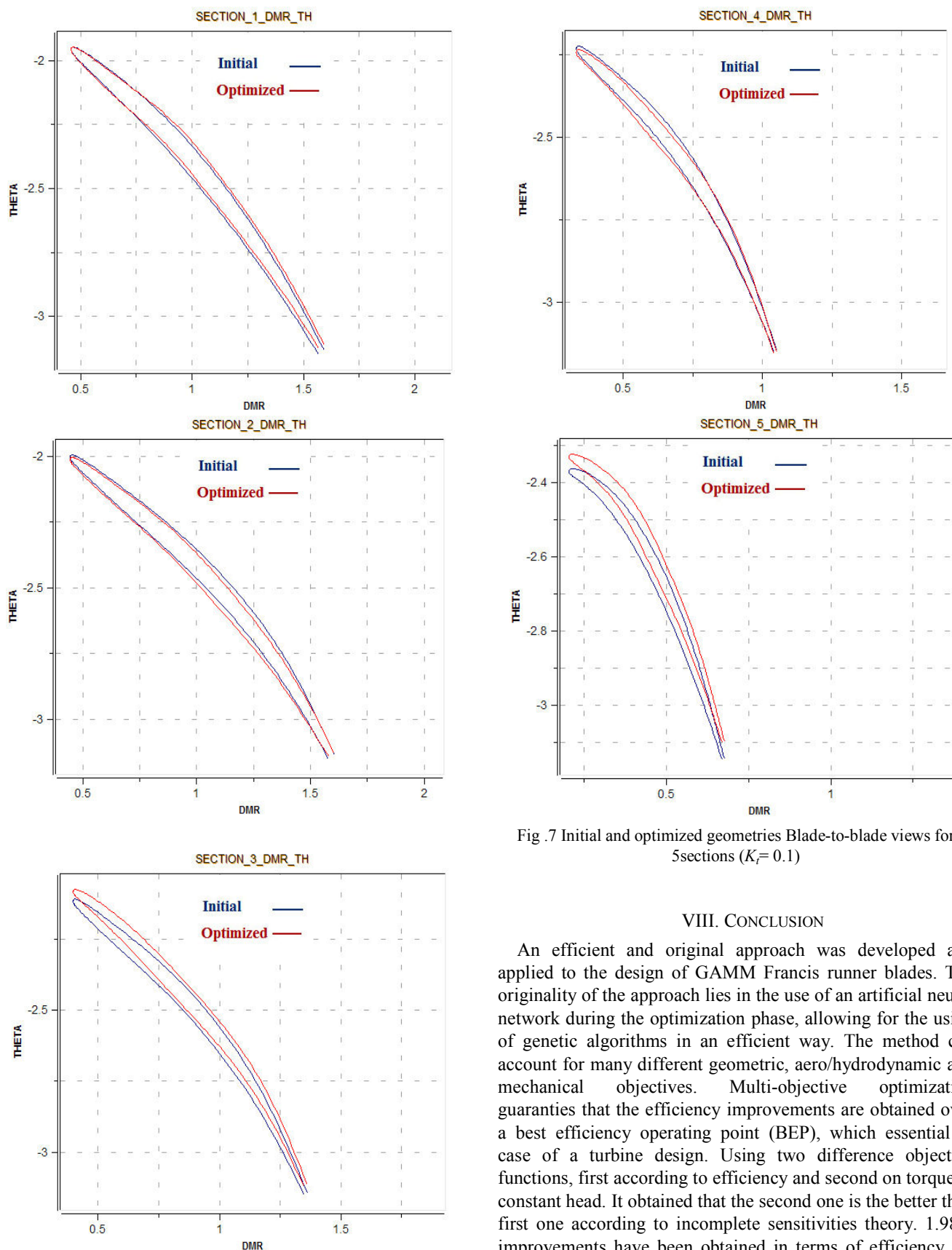
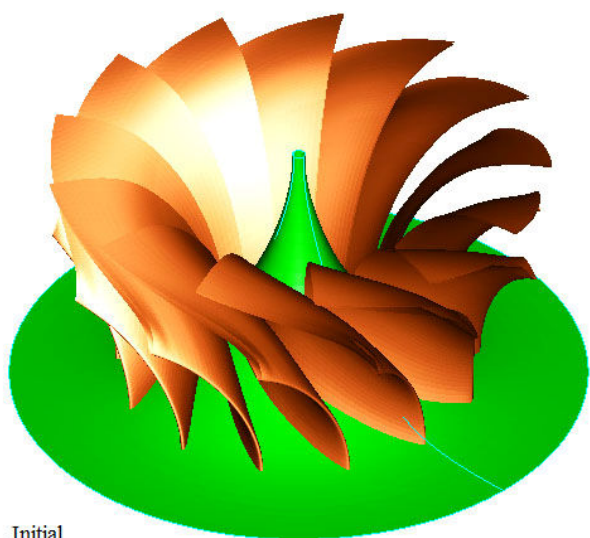

Fig.7 Initial and optimized geometries Blade-to-blade views for 5sections ($K_T=0.1$)

VIII. CONCLUSION

An efficient and original approach was developed and applied to the design of GAMM Francis runner blades. The originality of the approach lies in the use of an artificial neural network during the optimization phase, allowing for the using of genetic algorithms in an efficient way. The method can account for many different geometric, aero/hydrodynamic and mechanical objectives. Multi-objective optimization guaranties that the efficiency improvements are obtained over a best efficiency operating point (BEP), which essential in case of a turbine design. Using two difference objective functions, first according to efficiency and second on torque in constant head. It obtained that the second one is the better than first one according to incomplete sensitivities theory. 1.98% improvements have been obtained in terms of efficiency for GAMM Francis turbine ($K_T=0.1$). The new blade geometry presents much more changes in the camber line of sections 3

and 5. The new optimized turbine has had a 13.8% minimum static pressure increase. We noticed that there was 3.36% torque improvement and 1.51% head increasing.



Initial

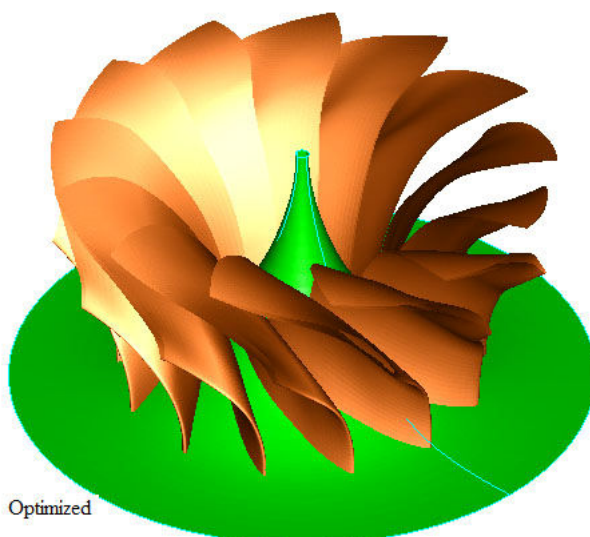

Optimized

Fig. 8 3D View of initial and optimized geometry ($K_r=0.1$)

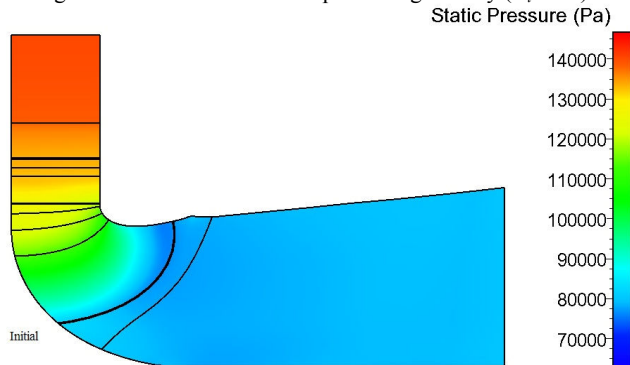

(a)

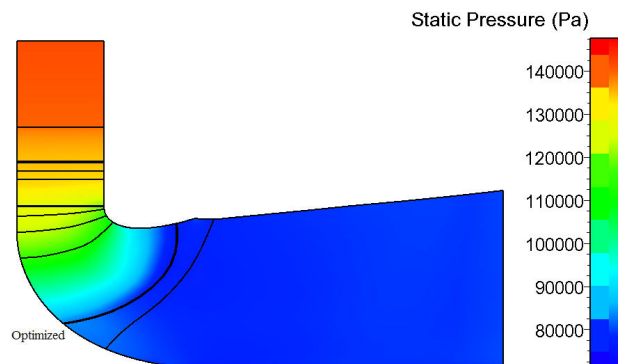

(b)

Fig. 9 Static pressure distributions along initial and optimized geometry ($K_r=0.1$)

REFERENCES

- [1] A. Demeulenaere, Ch. Hirsch, "Application of Multipoint Optimization to the Design of Turbomachinery Blades," *ASME Paper GT-2004-53110*.
- [2] G.N. Vanderplaats, *Numerical optimization techniques for engineering design*, McGraw-Hill, 1984.
- [3] D.E. Goldberg, *Genetic Algorithm*, Addison Wesley, 1994.
- [4] A. Demeulenaere, A. Purwanto, A. Ligout, C. Hirsch, R. Dijkers, F. Visser, "Design and Optimization of an Industrial Pump: Application of Genetic Algorithm and Neural Network," in *Proc of insert Conf. abbreviation, ASME Fluid Engineering Summer Conf.*, Houston, Texas, June 2005.
- [5] A. Alnaga, J.L. Kueny, "Optimal Design of Hydraulic Turbine Distributor," *WSEAS Transactions on Fluid Mechanics*, Issue 2, Volume 3, April 2008.
- [6] J.L. Kueny, R. Lestriez, A. Helali, and C. Hirsch, "Optimal design of a small hydraulic turbine," *22nd IAHR Symposium on Hydraulic Machinery and Systems*, Stockholm, Sweden, 2004.
- [7] H. Nilsson, L. Davidson, "A validation of parallel multiblock CFD against the GAMM Francis water turbine runner at best efficiency and off-design operating conditions," *Int.rep.01/02, Dept. of Thermo and Fluid Dynamics*, Chalmers University of Technology, Gothen-burg, 2001.
- [8] F. Avellan, P. Dupont, M. Farhat, B. Gindroz, P. Henry, M. Hussain, E. Parkinson, O. Santal, "Flow survey and blade pressure measurements in a Francis turbine model," *Pejovic S. (ed) Proceedings of the 15th IAHR Symposium on Hydraulic Machinery and Cavitation*, Belgrade, Yugoslavia, 1990, vol 2, I5, pp 1-14.
- [9] S. Derakhshan, B. Mohammadi and A. Nourbakhsh, "Incomplete Sensitivities for 3D Radial Turbomachinery Blade Optimization," *Comput. Fluids*, 37, pp. 1354-1363, 2008.
- [10] S. Derakhshan, B. Mohammadi and A. Nourbakhsh, "Efficiency Improvement of Centrifugal Reverse Pumps," *Journal of Fluids Engineering*, Vol. 131, 021103-1-9, February 2009.

Sh. Derakhshan is Assistant Professor at Mechanical Engineering Department, Iran University of Science and Technology, Tehran, Iran. (Phone: +982177240540; fax: +982177240448; e-mail: shderakhshan@iust.ac.ir).

A. Mostafavi is MSc Student at Mechanical Engineering Department, Iran University of Science and Technology, Tehran, Iran. (Phone: +982177240540; e-mail: amirhosein.mos@gmail.com).