

An Online Evaluation of Operating Reserve For System Security

Le-Ren Chang-Chien, Yin-Juin Lin, Chin-Chung Wu

Abstract—Utilities use operating reserve for frequency regulation. To ensure that the operating frequency and system security are well maintained, the operating grid codes always specify that the reserve quantity and response rate should meet some prescribed levels. This paper proposes a methodology to evaluate system's contingency reserve for an isolated power network. With the presented algorithm to estimate system's frequency response characteristic, an online allocation of contingency reserve would be feasible to meet the grid codes for contingency operation. Test results from the simulated conditions, and from the actual operating data verify the merits of the proposed methodology to system's frequency control, and security.

Keywords—Contingency, frequency control, operating reserve.

I. INTRODUCTION

OPERATING reserve is essential in system operation & control. Whenever a frequency incident occurs, one major function of the operating reserve is to provide adequate generation to support the network load and loss, and restore the frequency back to the nominal level. Because the response of the operating reserve could deeply influence the frequency restoration following the contingency, utilities are always interested in the methodologies of allocating effective power sources for operating reserve to ensure system security.

Fig. 1 illustrates the categories of operating reserve in system operation. Owing to the different purposes and the reserve responses, the operating reserve could be divided into two categories: one is the continuous operating reserve for frequency regulation. The other one is the occasional operating reserve for contingency.

Control areas utilize different kinds of reserves to deal with the frequency control [1], [2]. System's primary response is to halt the frequency excursion following the disturbance. Since the actions to stabilize the system frequency generally come from the direct governor response, units participating the primary control should be synchronically allocated [3]. After the primary response, the follow up action is to bring the frequency back to the nominal value. The AGC reserve is to provide available spinning unit margins for AGC to vary units' set-points in response to small load disturbances. However, for a credible disturbance such as a contingent event, more standby units that are synchronized or not synchronized

This work was supported in part by the National Science Council under grant NSC94-2213-E-006-123 and in part by Taiwan Power Company under grant TPC-546-2101-9403

Le-Ren Chang-Chien is with Electrical Engineering Department, National Cheng Kung University, Tainan, Taiwan.

Yin-Juin Lin is with Industrial Technology Research Institute, Tainan, Taiwan.

Chin-Chung Wu is with System Operation Department, Taiwan Power Company, Taipei, Taiwan.

Total Generation Available	Operating Reserve	Standby for Contingency	Tertiary Reserve (Backup Supply)	Primary Reserve (Spinning)
			Supplemental Reserve (Spinning & Non-Spinning)	
	Continuous for Regulation	AGC Reserve (Spinning)		
Forecasted Daily Load (Base & Schedule)				

Fig. 1. Categories of operating reserve in system operation

would be employed to make amends for the disturbance. Since the frequency restoration time for the different scales of the disturbances may range from the order of a few minutes to the order of ten minutes, units allocated for these kinds of reserves would be different [4].

This paper first presents the importance of system's β in frequency response analysis. Following that, we will introduce the real-time β estimate to portray frequency dynamics, and to calculate the contingency reserve. Issues related to the performance of the estimation method, such as the accuracy of the estimated β under time-varying system conditions, effectiveness of contingency reserve according to various operating cases will be presented in the following sections.

II. LFC DYNAMICS AND FREQUENCY RESPONSE

Fig. 2 demonstrates the primary, and supplementary control loops of load-frequency control for an isolated (single area) power system [6], [7], [8]. When the system encounters an instantaneous power imbalance from a disturbance, system frequency will start to deviate. If the frequency deviation $\Delta F(s)$ goes beyond the governor deadband, it will initiate the speed governors to adjust the power output for the frequency change. Such a primary control could be expressed in the form

$$\Delta P_{G1}(s) = -\frac{\Delta F(s)}{R_{eq}} \quad (1)$$

Consider the transfer function of the lumped generating unit model that is represented by $K(s)$,

$$K(s) = \frac{1}{T_g s + 1} \cdot \frac{1}{T_{ch} s + 1} \quad (2)$$

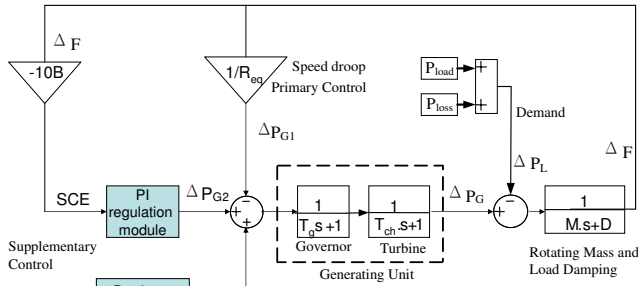

Fig. 2. The load frequency control loops for an isolated power system.

where T_g and T_{ch} are the equivalent governor's time constant and turbine's charging time constant of online units, respectively. Assuming the disturbance amount is $\Delta P_L(s)$, before the supplementary control takes effect, frequency excursion will be affected by the following electromechanical relation

$$\Delta F(s) = \{K(s) \cdot \Delta P_{G1}(s) - \Delta P_L(s)\} \cdot \frac{1}{Ms + D} \quad (3)$$

where D is also referred to as the load-frequency damping coefficient [9]. Substituting $\Delta P_{G1}(s)$ in (3) with (1), (3) yields

$$-\frac{\Delta F(s)}{\Delta P_L(s)} = \frac{1}{(Ms + D)} \cdot \frac{1}{(1 + \frac{K(s)}{R_{eq}} \cdot \frac{1}{Ms + D})} \quad (4)$$

Generally, the contingent disturbance could be approximated by a step change function (i.e. $\Delta P_L(s) = \Delta P_L/s$). Using the final-value theorem, (4) would be

$$\frac{-\Delta F}{\Delta P_L} = \lim_{s \rightarrow 0} \left\{ s \cdot \frac{\Delta F(s)}{\Delta P_L(s)} \right\} = \frac{1}{\frac{1}{R_{eq}} + D} \quad (5)$$

where ΔF is the static frequency deviation after the primary response. By definition [8], [9], [10], system's frequency response characteristic (FRC), β , is equivalent to

$$\beta = \frac{1}{R_{eq}} + D \quad (6)$$

where the value of β continuously varies with load type changes, and online governor responses. Therefore, (5) can be rewritten into the form

$$\Delta F = -\frac{\Delta P_L}{\beta} \quad (7)$$

From (7), we can see that the frequency drop is determined by the amount of generation loss, and β during the operating instant. Because β is not measurable, most utilities approximate this value using the relation

$$\beta = -\frac{\Delta P_L}{\Delta F} \quad (8)$$

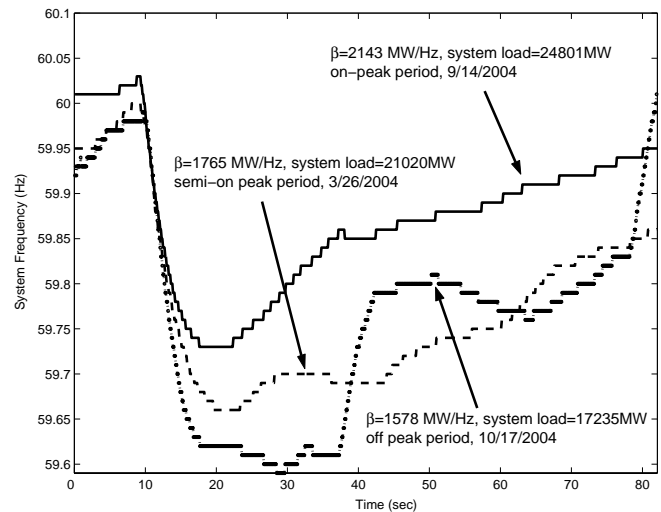

Fig. 3. Frequency excursion curves following 600 MW unit trips.

where β is numerically positive in the engineering unit of MW/Hz. Once the records of disturbance amount & frequency dip are available, β could be calculated accordingly [11], [12].

Fig. 3 shows three different frequency excursion curves following three cases of unit trip for the Taiwan power (Taipower) system. The solid-line, dot-line, and dash-line curves represent the 600 MW unit trip contingency occurred at different load conditions. The estimated β s are 2143 MW/Hz for 24801 MW system load during the on peak period, 1765 MW/Hz for 21020 MW system load during the semi-on peak period, and 1578 MW/Hz for 17235 MW system load during the off peak period. The frequency nadir of each curve shows that the higher the value of β , the higher the frequency nadir for the same amount of generation loss. It implies that the system is more able to withstand a contingency impact with a higher β . This result agrees with our derivation in (7). Another observation we obtained from Fig. 3 is that the frequency decline rate is dependent upon the lumped rotating inertia of the spinning units. However, β may vary with load-frequency damping coefficient, plant responses of the available spinning units. Therefore, the effect of higher system's β with increasing load may come from the higher load-frequency damping coefficient and more spinning units available for regulation.

To ensure power system security, under-frequency relays are commonly utilized in the load shedding protection. When system frequency declines under the pre-determined threshold, under-frequency relays will start to shed loads in order to restore the frequency. As far as system security is concerned, it is essential to evaluate the system's capability, and assure that under-frequency relay will not initiate the unexpected load shedding. As we illustrated from the aforementioned work, the system's β determines the frequency dip after the contingent event. As long as β could be obtained in real-time, we would be able to evaluate the extent of system security at all times, and dynamically allocate appropriate primary and contingency reserves if necessary.

III. STATE ESTIMATION OF β FOR THE ISOLATED POWER SYSTEM

The system's β could not only be obtained from the contingent event, but could be calculated from state estimation approach. Here, we propose the online β estimation algorithm for the isolated system. Consider the electromechanical power balance mechanism for the single area power system; the equation may be expressed from Fig. 2 as

$$\left\{ P_{G2}(s) - \frac{1}{R_{eq}} \Delta F(s) \right\} - P_L(s) = (D + Ms) \Delta F(s) \quad (9)$$

where $P_L(s)$ is the system load, and the unit transfer function is neglected at this point. Combining the primary response terms together, (9) would yield

$$P_{G2}(s) - P_L(s) = \left\{ \frac{1}{R_{eq}} + D \right\} \Delta F(s) + Ms \Delta F(s) \quad (10)$$

where $(1/R_{eq} + D)$ is equal to β . Substituting $(1/R_{eq} + D)$ with β , and taking the inverse Laplace transform of (10), the equation becomes

$$P_{G2}(t) - P_L(t) = \beta \Delta F(t) + M \Delta \dot{F}(t) \quad (11)$$

In practice, Taipower uses frequency bias B (MW/0.1Hz, numerically negative) to calculate the system control error (SCE) in the form

$$SCE = -10B \cdot \Delta F \quad (12)$$

Such SCE signal not only indicates Taipower's generating control error within its territory but is utilized as a control reference for Taipower's AGC [13]. The AGC forwards the pre-filtered SCE signal into the regulation module for power regulation. The total generated power dispatched by AGC could be expressed by the scheduled reference (P_{sch}) from the base-point module, and proportional & integral control references from regulation module [14],

$$P_{G2}(t) = -K_I \int SCE(t) dt - K_P SCE(t) + P_{sch}(t) \quad (13)$$

where K_P , and K_I are the proportional, and the integral gains, respectively. If the non-linearities inherent in the generating units could cause sizable response difference from the desired set point, a deviation variable P_{Gerr} could be introduced to account for the difference between desired and actual generation outputs. Therefore, (13) can be expressed as

$$P_{G2}(t) = -K_I \int SCE(t) dt - K_P SCE(t) + P_{sch}(t) + P_{Gerr}(t) \quad (14)$$

Replacing P_{G2} in (11) with (14), and taking the partial derivative of (11) with respect to t , the equation becomes

$$SCE(t) = -\frac{1}{K_I} \left\{ K_P \cdot \dot{SCE}(t) - \dot{P}_{sch}(t) - \dot{P}_{Gerr}(t) + \dot{P}_L(t) + \beta \Delta \dot{F}(t) + M \Delta \ddot{F}(t) \right\} \quad (15)$$

Our testing on the weighting of each term in (15) for most cases shows that $M \Delta \ddot{F}(t)$ is negligibly small compared with

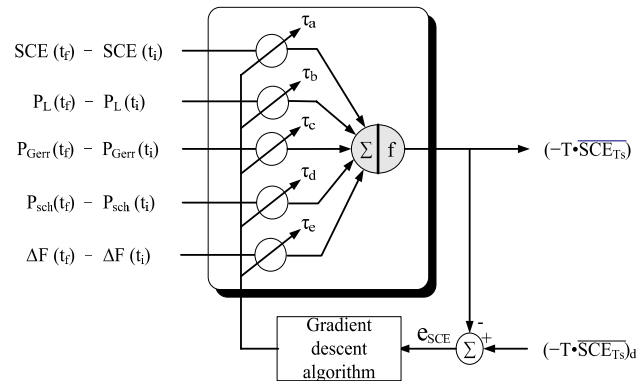

Fig. 4. The τ estimation scheme

other variables. Omitting $M \Delta \ddot{F}(t)$, (15) can be expressed as

$$SCE(t) = - \left\{ \tau_a \dot{SCE}(t) + \tau_b \dot{P}_L(t) - \tau_c \dot{P}_{Gerr}(t) - \tau_d \dot{P}_{sch}(t) + \tau_e \Delta \dot{F}(t) \right\} \quad (16)$$

where $\tau_a = K_P/K_I$, $\tau_b = \tau_c = \tau_d = 1/K_I$, and $\tau_e = \beta/K_I$.

To accommodate the algorithm into the digital system, (16) is converted into a difference equation, a sampling period of T_s seconds is selected, and (16) becomes

$$\overline{SCE}_{T_s}(t) = -\frac{1}{T_s} \left\{ \tau_a (SCE(t_f) - SCE(t_i)) + \tau_b (P_L(t_f) - P_L(t_i)) - \tau_c (P_{Gerr}(t_f) - P_{Gerr}(t_i)) - \tau_d (P_{sch}(t_f) - P_{sch}(t_i)) + \tau_e (\Delta F(t_f) - \Delta F(t_i)) \right\} \quad (17)$$

The equation parameters τ_a through τ_e could be varying due to the change of operating states in LFC. Therefore, the τ parameters have to be updated should system condition change. Such update could be achieved by recursive least square (RLS) algorithm. Given the sampled values of SCE , P_L , P_{Gerr} , P_{sch} , and ΔF which could be obtained from the AGC-SCADA system over a time period, the values of τ are estimated for the corresponding interval. The estimation algorithm sum up the input state variables with the associated system parameter τ 's to compare with the moving average of measured SCE for the T_{sec} interval. The sum square errors between the measured $\overline{SCE}_{T_s}(t)$ and sum of right-hand side of (17) could be minimized by the gradient algorithm. Once the sum square error is minimized, τ 's will converge to some specific values. The τ 's could be updated with system condition by given more new state inputs. The τ estimation scheme is illustrated by Fig. 4.

Suitable sampling period could affect the convergence of the algorithm, a preliminary test of sampling data to the τ estimation algorithm was tested. Our exam of the algorithm showed that a range between 40 to 60 s of sampling period T with 20 s updating rate would be the suitable window that the algorithm comes out with better performance.

Once τ 's are available for each updating step, β is calculated from the relation

$$\beta(t) = \tau_e / \tau_b \quad (18)$$

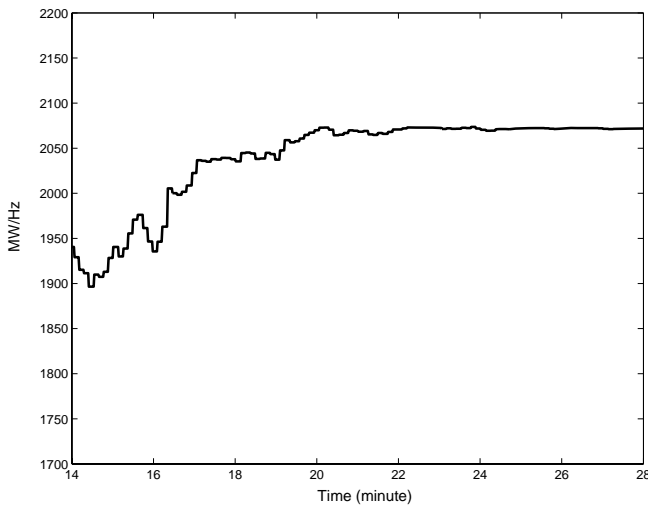

Fig. 5. Trace of β_{est} in Taipower system on 10/11/2005.

To accommodate the algorithm into the digital system, (18) is converted into a difference equation. For each time step k , the system's β is computed as

$$\beta(k) = \tau_e(k)/\tau_b(k) \quad (19)$$

The efficacy of β estimation was verified on the actual field data sampled from the Taipower system. A sample result from such a test is shown in Fig. 5. The estimating snapshot on 10/11/2005 was corresponding to on peak hours. It is noted that the varying β may result from the load variation, or the plant responses.

IV. EVALUATE POWER SYSTEM'S PRIMARY RESPONSE

When a system encounters a credible generation loss, the declined frequency is first affected by the damping of frequency-sensitive load and governor regulation of online units. Such mechanism is called the primary response. As far as system reliability is concerned, our first criterion is to assess whether the primary response is sufficient enough to stop the frequency excursion above the frequency level that will not initiate the first stage load-shedding. Therefore, the frequency nadir, F_1 , following the credible single unit contingency, could be obtained by the equation

$$F_1 = 60 - \frac{\Delta P_{Gmax}}{\beta_{est}} \quad (20)$$

where ΔP_{Gmax} is the amount of the most credible single contingency ($\Delta P_{Gmax} = 950$ MW in Taipower's case), and β_{est} is the real-time estimated β calculated from section III.

If F_1 is above the first stage load-shedding frequency threshold, the system's primary response is sufficient to avoid unexpected load shedding. Otherwise, system operators should allocate more governor free units, or adjust the units' speed-droop effects to increase the governor responses. The addition of primary response could be observed in real-time with the increasing value of β_{est} .

V. ALLOCATE OPERATING RESERVE FOR CONTINGENCY

A. Allocate fast instantaneous reserve for contingency

After the primary response, supplemental reserve is responsible to raise the frequency back to the nominal level. At the first stage of frequency restoration process, many utilities' operating standards require that the frequency should be restored to the prescribed safety frequency level, F_2 , within one minute following a single contingent event [5], [15], [16]. Because such reserve response should be fast, it is called the fast instantaneous reserve (FIR).

FIR is to allocate the partial-loaded online spinning units or interruptible load shedding (ILS) for this task. If the utilization of spinning units is the first option, the response time for raising the frequency would depend on the type of units. For example, Hydro and pumped-storage generators can respond within 10 s, and can ramp from 0 to 100% in one minute. Therefore, the hydro- & pumped-storage generators are the candidates to serve as FIR.

To define system's F_2 level, we use the form

$$F_2 = F_{thrsd} + 0.2 \quad \text{Hz} \quad (21)$$

where F_{thrsd} is relay's first stage frequency threshold for load shedding, and 0.2 Hz margin is to account for the effects of estimation error and load growth during the restoration period. Assuming the largest generation loss in the utility's single contingency record is ΔP_{Gmax} , we can derive the frequency deviation, ΔF_1 , following the generation loss ΔP_{Gmax} from (20)

$$\Delta F_1 = \frac{\Delta P_{Gmax}}{\beta_{est}} \quad (22)$$

Our observation shows that the system's β does not change widely when the amount of generation loss is comparably smaller than the system load. Therefore, we assume the system's β is the same as the pre-fault estimated β after the contingency. The amount of FIR in MW can be calculated as

$$\begin{aligned} FIR_{MW} &\geq \beta_{est} \cdot (\Delta F_1 - \Delta F_2) \\ &\geq \beta_{est} \cdot \left(\frac{\Delta P_{Gmax}}{\beta_{est}} - \Delta F_2 \right) \\ &\geq \Delta P_{Gmax} - \beta_{est} \cdot \Delta F_2 \end{aligned} \quad (23)$$

where $\Delta F_2 = 60 - F_2$. To restore the frequency back to F_2 within one minute, the equivalent ramp up rate for the units participating FIR should be equal or larger than FIR_{MW} in (MW/min). In the Taipower system, the first stage load-shedding frequency is set at 59.5 Hz with 50 s time delay. Whenever the frequency excursion trend is approaching 59.5 Hz, FIR will respond to raise up the frequency.

Generally, the summer on-peak hours and drought season are usually the most challenging time for Taipower to allocate appropriate FIR due to the limited source constraints. When hydro- or pumped-storage units could not fully support the FIR, allocating enough ILS quantity is the alternative.

Fig. 6 shows a frequency curve following the loss of a 950 MW unit due to the insufficient FIR case. On 06/06/2002, the system load was 21700 MW with an estimated β of about 1727 MW/Hz. The frequency excursion curve in Fig. 6 shows the frequency dropped to 59.44 Hz from the pre-fault frequency

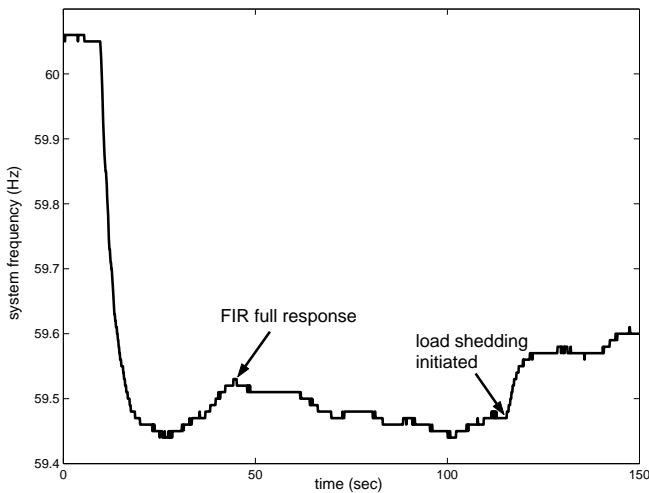

Fig. 6. Frequency curve following a loss of the largest generating unit on 06/06/2002.

at 60.04 Hz. From (23), the required FIR was about 430 MW in order to restore the frequency back to 59.7 Hz. However, owing to the water shortage during that season, the available FIR that can be allocated to hydro- and pumped-storage units were 170 MW. The deviated frequency was raised above 59.5 Hz after the full response of 170 MW FIR in about 20 seconds. However, the deficient frequency margin, and the slow follow-up thermal units, could not catch up with the increasing load demand. It resulted in a further frequency dip below 59.5 Hz again, and initiated 182.76 MW unexpected load shedding. Following the load shedding, the frequency rose to 59.58 Hz within 5 seconds. If the thermal units could not respond fast enough to raise up the frequency, such 0.08 Hz margin could not prevent another possible load shedding. If ILS is our option in FIR scheduling, the quantity of ILS that may apply to this case is

$$ILS = 430 - 170 = 260 \text{ MW} \quad (24)$$

Fig. 7 shows the simulation result that verifies our evaluation. A 260 MW ILS was initiated after the full response of a 170 MW hydro spinning reserve in 10 seconds. The ILS response apparently brought the frequency back above 59.7 Hz in 6 seconds. From the simulation result, we can confirm that cooperating dynamic ILS with FIR allocating method appears to be feasible in the limited fast spinning reserve condition. In the deregulated power environment, when ILS is considered as an alternative of ancillary service, its contributions to system reliability and associated market interest are attracting more attention.

Shutting down the pumped-storage (PMPS) units operating in pumping mode is equivalent to load shedding [1], [17]. For utilities that have PMPS units, the amount of pumping load could replace parts of the fast spinning unit or ILS in (23).

B. Allocate sustained instantaneous reserve for contingency

After frequency has been restored to the F_2 level after the full response of FIR, the sustained instantaneous reserve (SIR)

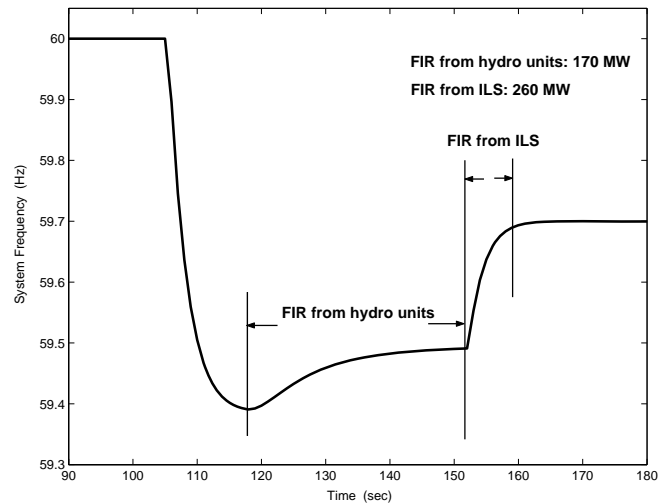

Fig. 7. Simulation result of FIR with ILS application to the case of 06/06/2002.

is necessary to quickly bring the frequency back to the nominal operating level. Assuming the deviated frequency following a contingent event should be brought back to 60 Hz, the frequency operating range that SIR intends to serve is between F_2 , and 60 Hz. The required SIR is calculated as

$$SIR_{MW} \geq \beta_{est} \cdot (60 - F_2) \text{ MW} \quad (25)$$

In the Taipower system, the operating standards also require that the overall frequency restoration process following a single contingent event should be completed within 5 minutes. Therefore, SIR's ramp up rate should be at least $SIR_{MW}/(5-1)$ MW/min for a single contingency, where 1 minute is FIR's full response time. Although SIR does not require units to be fast enough to ramp up their generating outputs as FIR units, our experience shows that SIR's ramp up rate is still substantial. The larger the ramp up rate, the better the system frequency can bear another contingent event. Generally, the average response time of LNG combined-cycle plants is within 10 seconds. Their ramp rates range from 10 to 21 MW/min. As a result, most SIR units are LNG combined-cycle units, online spinning combustion generators, and fast cold-start combustion turbines.

Fig. 8 shows the frequency restoration curve from a simulation using the proposed FIR, and SIR evaluation methods. With a system load of 22626 MW, and β of 1862 MW/Hz, the system encountered a 950 MW generation loss from 60 Hz, the 391 MW FIR quickly raised the frequency from 59.49 Hz to 59.70 Hz, and the follow up 559 MW SIR restored the frequency back to 60 Hz within 5 minutes. It is noted that the sum of FIR and SIR is equal to the amount of the 950 MW generation loss.

C. Schedule the backup supply

The task of backup supply is to replace the roles of FIR and SIR so that part of the fast spinning units could be released and ready for another possible contingent impact. The amount

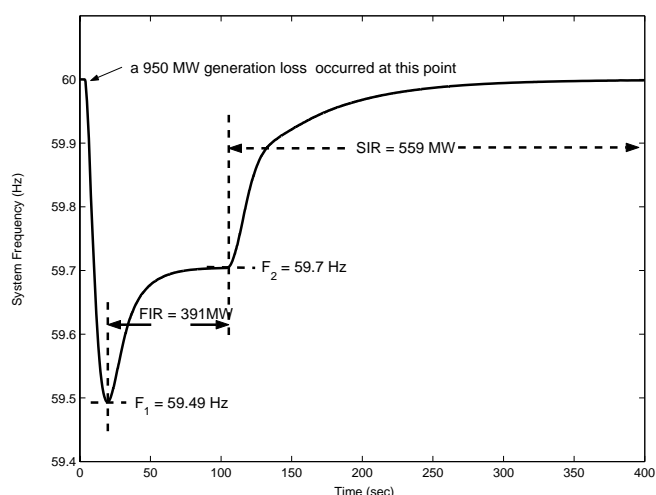

Fig. 8. Simulation result of the frequency restoration curve following a credible generation loss.

of the backup supply is shown in the form

$$BS_{MW} \geq \Delta P_{G_{max}} \quad MW \quad (26)$$

where $\Delta P_{G_{max}}$ is the defined single contingency amount. Units that allocated for backup supply could be slower spinning thermal plants, and some non-spinning generators.

VI. CONCLUSIONS

In this paper, we have illustrated the potential benefit of estimating a system's β in reserve scheduling for an isolated power system. The field test of the β estimate showed that the traceability of the estimating algorithm was performing well in tracking frequency response dynamics.

This paper also presented an online allocation of contingency reserve using the proposed estimation algorithm. Steps of the reserve allocation process (FIR and SIR) based on the preset frequency levels are planned to meet the different frequency response requirements. Results from our simulation tests do confirm such methods in ensuring system's security under the time varying operating condition.

VII. ACKNOWLEDGEMENT

The authors are greatly indebted to the Taiwan Power Company for the provision of frequency response data to publish this paper.

REFERENCES

- [1] C.C. Wu and N. Chen, "Frequency-based method for fast-response reserve dispatch in isolated power systems," *IEE Proc., -Gener. Transm. Distrib.*, vol: 151(1), pp. 73-77, 2004.
- [2] G.A. Chown and B. Wigdorowitz "A methodology for the redesign of Frequency Control for AC Networks," *IEEE Trans. Power Syst.*, vol: 19(3), pp. 1546-1554, Aug. 2004.
- [3] G.A. Chown and M.G. Coetzee "Implementation of regulation as an ancillary service in Eskom and use of the Eskom internal web for this service," *IEEE Trans. Power Syst.*, vol: 15(3), pp. 1132-1136, Aug. 2000.
- [4] F.D. Galiana, F. Bouffard, J.M. Arroyo, and J.F. Restrepo "Scheduling and pricing of coupled energy and primary, secondary, and tertiary reserves," *IEEE Proc.*, vol: 93(11), pp. 1970-1983, Nov. 2005.

- [5] C.C. Wu and N. Chen "Online methodology to determine reasonable spinning reserve requirement for isolated power systems," *IEE Proc., -Gener. Transm. Distrib.*, vol: 150, pp. 455-461, 2003.
- [6] S.-J. Huang, and C.-C. Huang, "An automatic load shedding scheme including pumped-storage units," *IEEE Trans. Energy Conv.*, vol: 15(4), pp. 427-432, Dec. 2000.
- [7] A.J. Wood, and B.F. Wollenberg *Power generation, operation and control*, John Wiley Interscience., 2nd, Ed. New York, 1996.
- [8] P. Kundur *Power system stability and control*, McGraw-Hill, Inc., 1994.
- [9] N. Jaleeli, L.S. VanSlyck, D.N. Ewart, L.H. Fink and A.G. Hoffman, "Understanding Automatic Generation Control," *IEEE Trans. Power Syst.*, vol: 7, pp. 1106-1122, Aug. 1992.
- [10] T. Kennedy, S.M. Hoyt and C.F. Abell "Variable, Non-linear Tie-Line Frequency Bias For Interconnected System Control," *IEEE Trans. Power Syst.*, Vol: 3, pp. 1244-1253, Aug. 1988.
- [11] *NERC operating manual*, North American Electric Reliability Council, Feb., 2006.
- [12] S.P. Hoffman "Frequency response characteristic study for ComED and the eastern interconnection," *Proc. American Power Conf.*, vol: 59, pp. 1019-1022, 1997.
- [13] *Power system operation standards and manual*, Taipower Power Company, Taipei, 2000.
- [14] L.-R. Chang-Chien, C.M. Ong, and R.A. Kramer "Field tests and refinements of an ACE model," *IEEE Trans. Power Syst.*, Vol: 18(2), pp. 898-903, May. 2003.
- [15] R.J. Koessler, J.W. Feltes and J.R. Willis "A methodology for management of spinning reserve requirements," *IEEE PES Winter Meeting.*, vol: 1, pp. 584-589, 1999.
- [16] I.A. Erinmez, D.O. Bickers, G.F. Wood and W.W. Hung "NGC experience with frequency control in England and Wales-provision of frequency response by generators," *IEEE PES Winter Meeting.*, vol: 1, pp. 590-596, 1999.
- [17] S.-J. Huang, and C.-C. Huang, "Adaptive approach to load shedding including pumped-storage units during underfrequency conditions," *IEE Proc., -Gener. Transm. Distrib.*, vol: 148(2), pp. 165-171, March. 2001.

Le-Ren Chang-Chien received the Ph.D. degree from Purdue University, West Lafayette, IN, USA, in 2002. He joined the Department of Electrical Engineering at National Cheng Kung University, Tainan, Taiwan, as an Assistant Professor in 2003. His research interests include electric machines, power system operation, control, and reliability.

Yin-Juin Lin was born in Yunlin, Taiwan on May 1, 1979. He received the B.E. degree in Electrical Engineering from National Taiwan University of Science and Technology, Taipei, Taiwan, in 2004, and M.S. degree in Electrical Engineering from National Cheng Kung University, Tainan, Taiwan. At present, he is a technical Engineer at Industrial Technology Research Institute, Tainan, Taiwan. His research interests include power electronic application, reliability analysis, and control of electrical power systems.

Chin-Chung Wu was born in February, 1964 in Taipei, Taiwan, Republic of China. He received his BSEE, and MSEE degrees in electrical engineering from National Taiwan Institute of Technology in 1990, and 1993, respectively. He obtained his Ph.D. degree in electrical engineering from National Taiwan University of Science and Technology in 2003.

From 1990 through 1996, Dr. Wu worked as an engineer in the Taipei Area Dispatch Control Center of the Taiwan Power Company. Since 1996, he has worked as a chief dispatching engineer. Dr. Wu currently works in the System Operations Department of the Taiwan Power Company, with responsibilities for the Taiwan Power System Dispatch Operations. His research interests are in power system operation & analysis, particularly in system securities, voltage regulation, and dispatch control. Dr. Wu is a Registered Professional Engineer of Taiwan, Republic of China.