

Using Genetic Algorithm for Distributed Generation Allocation to Reduce Losses and Improve Voltage Profile

M. Sedighzadeh, and A. Rezazadeh

Abstract—This paper presents a method for the optimal allocation of Distributed generation in distribution systems. In this paper, our aim would be optimal distributed generation allocation for voltage profile improvement and loss reduction in distribution network. Genetic Algorithm (GA) was used as the solving tool, which referring two determined aim; the problem is defined and objective function is introduced. Considering to fitness values sensitivity in genetic algorithm process, there is needed to apply load flow for decision-making. Load flow algorithm is combined appropriately with GA, till access to acceptable results of this operation. We used MATPOWER package for load flow algorithm and composed it with our Genetic Algorithm. The suggested method is programmed under MATLAB software and applied ETAP software for evaluating of results correctness. It was implemented on part of Tehran electricity distributing grid. The resulting operation of this method on some testing system is illuminated improvement of voltage profile and loss reduction indexes.

Keywords—Distributed Generation, Allocation, Voltage Profile, losses, Genetic Algorithm.

I. INTRODUCTION

BEFORE installing distributed generation, its effects on voltage profile, line losses, short circuit current, amounts of injected harmonic and reliability must be evaluated separately. The planning of the electric system with the presence of DG requires the definition of several factors, such as: the best technology to be used, the number and the capacity of the units, the best location, the type of network connection, etc. The impact of DG in system operating characteristics, such as electric losses, voltage profile, stability and reliability needs to be appropriately evaluated. The problem of DG allocation and sizing is of great importance. The installation of DG units at non-optimal places can result in an increase in system losses, implying in an increase in costs and, therefore, having an effect opposite to the desired. For that reason, the use of an optimization method capable of indicating the best solution for a given distribution network can be very useful for the system planning engineer. The selection of the best places for installation and the preferable

size of the DG units in large distribution systems is a complex combinatorial optimization problem.

The optimal placement and sizing of generation units on the distribution network has been continuously studied in order to achieve different aims. The objective can be the minimization of the active losses of the feeder [1], [2]; or the minimization of the total network supply costs, which includes generators operation and losses compensation [3], [4], [5], [6]; or even the best utilization of the available generation capacity [7]. As a contribution to the methodology for DG economical analysis, in this paper it is presented an algorithm for the allocation of generators in distribution networks, in order to voltage profile improvement and loss reduction in distribution network. The Genetic Algorithm is used as the optimization technique. In Section 2 it is presented a brief discussion about distributed generation issues and Section 3 is an introduction to the Genetic Algorithm. The problem formulation is presented in Section 4 and the proposed solution method is discussed in Section 5. It is presented an application example in Section 6 and finally, the conclusions.

II. DISTRIBUTED GENERATIONS

A general definition was then suggested in [8] which are now widely accepted as follows: ‘‘Distributed Generation is an electric power source connected directly to the distribution network or on the customer site of the meter’’. The definitions of DG do not define the technologies, as the technologies that can be used vary widely. However, a categorization of different technology groups of DG seems possible, such as, non-renewable DG and renewable DG. From distribution system planning point of view, DG is a feasible alternative for new capacity especially in the competitive electricity market environment and has immense benefit such as [6]: Short lead-time and low investment risk since it is built in modules, Small-capacity modules that can track load variation more closely, Small physical size that can be installed at load centers and does not need government approval or search for utility territory and land availability, Existence of a vast range of DG technologies.

For these reasons, the first signs of a possible technological change are beginning to arise on the international scene, which could involve in the future the presence of a consistently generation produced with small and medium size plants directly connected to the distribution network (LV and MV) and characterized by good efficiencies and low

Manuscript received January 5, 2008

The Authors are with Faculty of Electrical and Computer Engineering, Shahid Beheshti University, Tehran, 1983963113, Iran (phone: +98-21-29902290, fax: +98-21-22431804, e-mail: m_sedighi@sbu.ac.ir).

emissions. This will create new problems and probably the need of new tools and managing these systems.

III. GENETIC ALGORITHM

Genetic Algorithm is a general-purpose search techniques based on principles inspired from the genetic and evolution mechanisms observed in natural systems and populations of living beings. Their basic principle is the maintenance of a population of solutions to a problem (genotypes) as encoded information individuals that evolve in time [6].

Generally, GA comprises three different phases of search:

Phase 1: creating an initial population; phase 2: evaluating a fitness function; phase 3: producing a new population. A genetic search starts with a randomly generated initial population within which each individual is evaluated by means of a fitness function. Individual in this and subsequent generations are duplicated or eliminated according to their fitness values. Further generations are created by applying GA operators. This eventually leads to a generation of high performing individuals.

There are usually three operators in a typical genetic algorithm [6]: the first is the production operator (elitism) which makes one or more copies of any individual that posses a high fitness value; otherwise, the individual is eliminated from the solution pool; the second operator is the recombination (also known as the 'crossover') operator. This operator selects two individuals within the generation and a crossover site and carries out a swapping operation of the string bits to the right hand side of the crossover site of both individuals. Crossover operations synthesize bits of knowledge gained from both parents exhibiting better than average performance. Thus, the probability of a better offspring is greatly enhanced; the third operator is the 'mutation' operator. This operator acts as a background operator and is used to explore some of the invested points in the search space by randomly flipping a 'bit' in a population of strings. Since frequent application of this operator would lead to a completely random search, a very low probability is usually assigned to its activation.

IV. PROBLEM FORMULATION

The main goal of the proposed algorithm is to determine the best locations for new distributed generation resources by minimizing different function, related to project aims. In this work, we are following two goals for determining the formula that are used in point of start:

1. loss Reduction
2. voltage profile Improvement

These items should compose with constraints to obtain the proper objective functions. The main constraints in the optimization process in the proposed methodology are:

1. Losses before installing DG in power grid should be less than losses after installing of it.

$$LOSS_{with\ DG} \leq LOSS_{without\ DG}$$

2. Voltage constraint

$$V_{bus\ min} \leq V_{bus} \leq V_{bus\ max}$$

The objective function, with composing constraints and goals, is determined as following:

$$MaxF = k_1 \left\{ Max \left[0, \frac{1}{n} \sum_{i=1}^n (Voltage\ \%_{i_{withDG}} - Voltage\ \%_{i_{withoutDG}}) \right] \right\} \\ + k_2 \left\{ Max \left[0, \left(\sum_{j=1}^m P_{j_{withoutDG}} - P_{j_{withDG}} \right) \right] \right\} \\ k_3 \left\{ Max \left[0, \left(\sum_{j=1}^m Q_{j_{withoutDG}} - Q_{j_{withDG}} \right) \right] \right\}$$

First term in this expression, related to difference between average of voltage profile percentage in base case and other cases according to DG's locations. By this way summation of active and reactive power losses difference are computed and objective function is established. *Max* operator is used for enforcing the constraints. The negative values influence is forbidden by this operator. Mentioned parameters are listed below:

$Voltage\ \%_{i_{withDG}}$: Voltage Percent in *i*th bus with DG resource.

$Voltage\ \%_{i_{withoutDG}}$: Voltage Percent in *i*th bus without DG

resource.

$P_{i_{withDG}}$: Active Power Losses in *j*th branch with DG resource.

$P_{i_{withoutDG}}$: Active Power Losses in *j*th branch without DG

resource.

$Q_{i_{withDG}}$: Reactive Power Losses in *j*th branch with DG

resource.

$Q_{i_{withoutDG}}$: Reactive Power Losses in *j*th branch without DG

resource.

k_1, k_2, k_3 : Emphasis or penalty factors

n : Number of Buses

m : Number of Branches.

V. PROPOSED ALGORITHM

Although using algorithm genetic is applied to this optimization problem, but we think objective functions are different so this algorithm is chosen for Distributed Generation allocation in this research. GAs are able to reach a good solution - with high probability to be the best one - by a finite steps of evolution steps performed on a finite set of possible solutions. Some objective function for optimization problem is the minimization of:

1. The cost due to system losses
2. The network upgrading investments
3. The generation cost (investments fuel, operation and maintenance)

The flow chart of our manner is shown in Fig. 1. Genetic Algorithm sets in the core of it and load flow algorithm is

used in everywhere that evaluation process is essential. First of all, base case network is evaluated and its indexes are registered. In the main path of it, Genetic Algorithm meaningful search to find the optimum place for installing DG. This routine is programmed under MATLAB software.

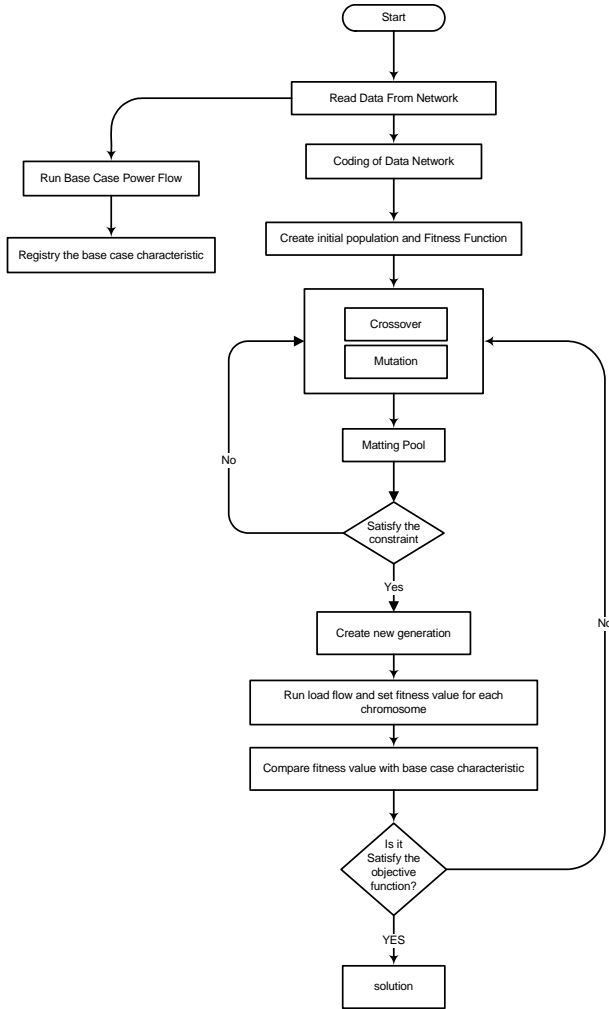

Fig. 1 Flow chart of implemented methodology

VI. CASE STUDY

Other system was selected from one part of Tehran distribution network. Single line diagram of the network is shown in Fig. 2. ETAP software (ETAP PowerStation is a strong analyzer program that is used for checking the obtained result from MATLAB). This is MV feeder with 13 buses from 63/20 kV Khoda-Bande-Loo substation. Table I illustrates line and bus information. The advantage of using this network should be its practicality.

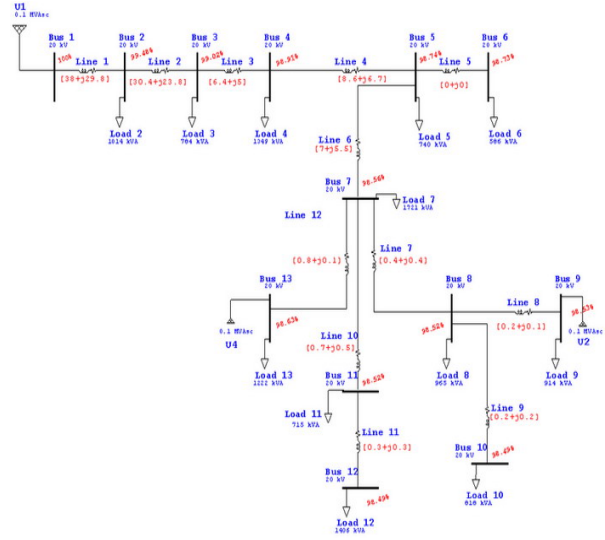

Fig. 2 Single Line Diagram of the Khoda Bande Loo feeder in ETAP space

TABLE I
LINE INFORMATION

Line Characteristics			
From	To	R ^{ohm}	X ^{ohm}
1	2	0.176	0.138
2	3	0.176	0.138
3	4	0.045	0.035
4	5	0.089	0.069
5	6	0.045	0.035
5	7	0.116	0.091
7	8	0.073	0.073
8	9	0.074	0.058
8	10	0.093	0.093
7	11	0.063	0.05
11	12	0.068	0.053
7	13	0.062	0.053

Two DG resources are used for improving of network indexes. Both of them have 1600^{kw} and 0.01^{kVar}. For normalizing fitness values that are attained during performing the routine, following points are intended:

- Three constant values are:

$$SAP = \sum_{i=1}^{12} P_i \quad (1)$$

$$SRP = \sum_{i=1}^{12} Q_{i_{withoutDG}}$$

$$AVP = \frac{1}{13} \sum_{j=1}^{13} Voltage\%_j_{withoutDG}$$

$$MaxF = \frac{1000}{AVP} \left\{ \text{Max} \left[0, \frac{1}{13} \left(\sum_{i=1}^{12} Voltage\%_{i_{withoutDG}} - AVP \right) \right] \right\} + \frac{700}{SAP} \left\{ \text{Max} \left[0, \left(SAP - \sum_{j=1}^{12} P_{j_{withoutDG}} \right) \right] \right\} + \frac{200}{SRP} \left\{ \text{Max} \left[0, \left(SRP - \sum_{j=1}^{12} Q_{j_{withoutDG}} \right) \right] \right\} \quad (2)$$

TABLE II
 BUS INFORMATION

Bus Characteristics		
Bus Number	P ^{kw}	Q ^{kvar}
1	0	0
2	890	468
3	628	470
4	1112	764
5	636	378
6	474	344
7	1342	1078
8	920	292
9	766	498
10	662	480
11	690	186
12	1292	554
13	1124	480

In this expressions SAP is summation of branches Active Power Losses in base case, SRP is summation of branches Reactive Power Losses in base case and AVP is Average of Voltage Percent in base case.

- Maximum amounts of active and reactive power losses summation for buses are occurred when DG resources not installed in the network (base case).
- Minimum amounts of voltage percent average for buses are occurred in base case.
- With this constant values, objective function normalized as following expression:

Emphasis factor for each terms are: $k_1 = 1000$; $k_2 = 700$ and $k_3 = 200$. With this expression, the best location is bus 9 and 13.

Genetic Algorithm has a matting pool that new generations are exist with GA operators. However the number of chromosomes which are injected into matting pool be more, the number of offspring will be highness. If this number is not proper, a purpose location, close to absolute optimal point is selected or time is grown up.

Voltage percent and power losses in base case and all possible cases with installing DG are illustrated in Fig. 3 and 4.

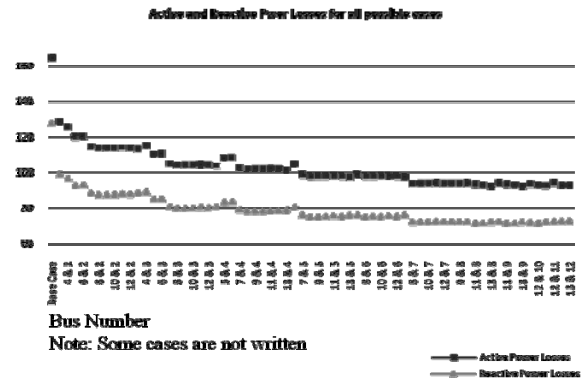

Fig. 3 Comparing Total Power Losses for all possible cases

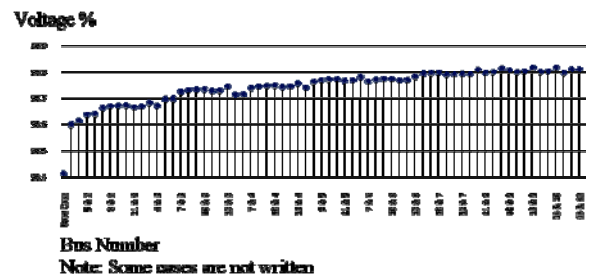

Fig. 4 Comparing Average of Percent for all possible cases

Results for installing of two DG on bus 3 and 9 are shown in following figures:

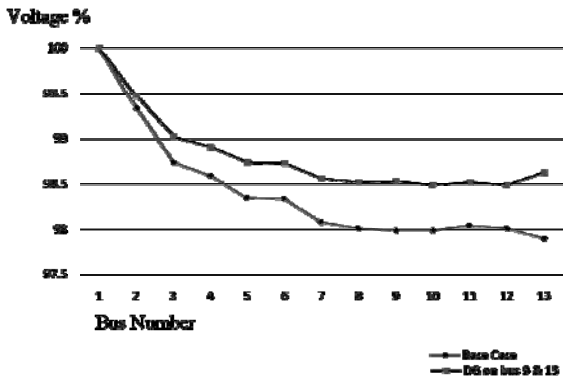

Fig. 5 Average voltage percent for base case and DG installed on bus 9 and 13

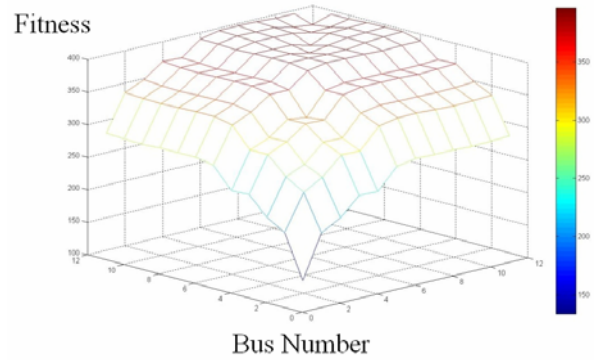

Fig. 8 Surface diagram of fitness values

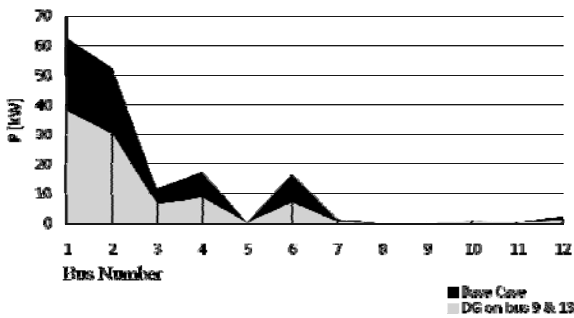

Fig. 6 Total active power losses for base case and DG installed on bus 9 and 13

For assurance of result validity, all possible cases are calculated. You should see them in Fig. 7. If fitness values are indicated in a matrix, because of the same selected capacities for both DG resources, it is symmetrical. For example the element 2, 4 is same amount as 4, 2. Element 2, 4 point to the fitness value which comes from installing DG on bus 2 and 4. Fig. 8 shows this value in surface diagram. It is clear that, these values are increased, with closing to the last buses.

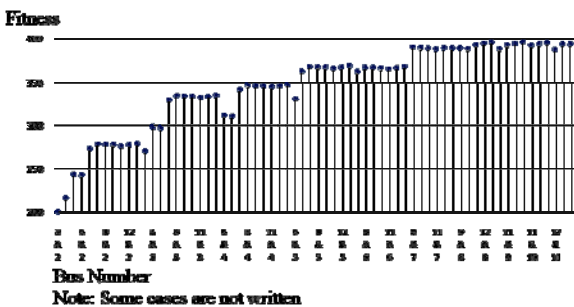

Fig. 7 Comparing fitness values for all possible cases

With analyzing of simulations we can conclude:

1. The appropriate selection of the first population is effected on algorithm convergence. So be sure about grid coding correctness and them fitness values.
2. For Distributed Generation resource placing in network with lower number of buses, disabling the GA operators, cause to convert GA to direct search. Absolute optimal point is given by this way and in case of increasing the number of buses, even with one distributed generation resource, direct research finished by increasing of calculating and passing time.
3. Considering the load flow algorithm, one disadvantage of GA in this routine is increasing of computing level and passing time. The maximum style of installing DG for 13 buses case study with two distributed generation source is 78 time. Finding the best solution without performing routine for all possible cases is art of GA by using its operator and valuing method. Part of computing and passing time is related to use multi objective genetic algorithm.
4. Lack of updatable and available information bank which is contained specification of distribution network in different part of the country would be a failure in continuous connection between university researches and electricity industry. Existing such information based on reality need for applying university theory researches practically.
5. In running our algorithm, whatever amounts of chromosomes which enter in mating pool are higher, it closes to absolute solution, but if this amounts to be low, it has a point near the absolute solution.
6. To comprehensive evaluate of this system, we compose tow DG sources and cerate a matrix for all available cases. For example element 22 of this matrix illuminate fitness of installing DG with double capacity on bus number 2.

After analyzing this matrix best values are yield as following:

TABLE III
COMPARE RESULTS

Bus No.	Voltage % mean	Active Power Losses	Total Reactive Power Losses (kw)	Fitness
13	<u>98.823</u>	100.5	74	361.47
13 & 9	98.81	<u>92.9</u>	72.3	396.35
12 & 9	98.803	93.5	<u>71.7</u>	394.60

As you see in this Table III best amounts are shown. The algorithm has been used this values for its decision criteria. Maximum of mean voltage percent, occur when DG installed at bus 13 ($3200^{kw} = 1600^{kw} + 1600^{kw}$). Minimum total of active power losses occur when DG install at buses 9 and 13, also minimum amount of total reactive power occur when DG install at buses 12 and 9. The last column shows fitness value of this best point, but notes that, weight factors have clear effects on fitness.

7. This surface diagram in Fig. 8 is shown that:

- Installing DG in every bus improve network characteristic, in other hand totally installing DG has proper effects in this system.
- Whatever you close to last bus, fitness value is more important.

VII. CONCLUSION

In this paper the results of application of GA algorithm to the optimal allocation of DGs in distribution network is presented. The effectiveness of the proposed algorithm to solve the DG allocation problem is demonstrated through a numerical example. The Khoda Bande Loo distribution test feeder in Tehran has been solved with the proposed algorithm and, the simple genetic algorithm.

REFERENCES

- [1] K. Nara, Y. Hayashi, K. Ikeda, and T. Ashizawa, "Application of tabu search to optimal placement of distributed generators," in Proc. 2001 IEEE Power Engineering Society Winter Meeting, pp. 918-923.
- [2] T. K. A. Rahman, S. R. A. Rahim, and I. Musirin, "Optimal allocation and sizing of embedded generators," in Proc. 2004 National Power and Energy Conference, pp.288-294.
- [3] G. Celli, and F. Pilo, "Optimal distributed generation allocation in MV distribution networks," in Proc.2001 IEEE PICA Conference, pp. 81-86.
- [4] W. El-Khattam, K. Bhattacharya, Y. Hegazy, and M. M. A. Salama, "Optimal investment planning for distributed generation in a competitive electricity market," IEEE Trans. Power Systems, vol. 19, pp. 1674-1684, Aug.2004.
- [5] W. El-Khattam, Y. G. Hegazy, and M. M. A. Salama, "An integrated distributed generation optimization model for distribution system planning," IEEE Trans. Power Systems, vol. 20, pp. 1158-1165, May 2005.
- [6] M. Gandomkar, M. Vakilian, M. Ehsan, " A combination of genetic algorithm and simulated annealing for optimal DG allocation in

distribution networks", CCECE/CCGEI, Saskatoon, May 2005 IEEE, PP.645-648.

- [7] A. Keane, and M. O'Malley, "Optimal allocation of embedded generation on distribution networks," IEEE Trans. Power Systems, vol. 20, pp. 1640-1646, Aug. 2005.
- [8] Distributed generation: a definition; Thomas Ackermann , Göran Andersson, Lennart Söder; Electric Power Systems Research 57 (2001) 195-204; December 2000.



M. Sedighzadeh received the B.S. degree in Electrical Engineering from the Shahid Chamran University of Ahvaz, Iran and M.S. and Ph.D. degrees in Electrical Engineering from the Iran University of Science and Technology, Tehran, Iran, in 1996, 1998 and 2004, respectively. From 2000 to 2007 he was with power system studies group of Moshanir Company, Tehran, Iran. Currently, he is an Assistant Professor in the Faculty of Electrical and Computer Engineering, Shahid Beheshti University, Tehran, Iran. His research interests are Power system control and modeling, FACTS devices and Distributed Generation.



A. Rezazade was born in Tehran, Iran in 1969. He received his B.Sc and M.Sc. degrees and Ph.D. from Tehran University in 1991, 1993, and 2000, respectively, all in electrical engineering. He has two years of research in Electrical Machines and Drives laboratory of Wuppertal University, Germany, with the DAAD scholarship during his Ph.D. and Since 2000 he was the head of CNC EDM Wirecut machine research and manufacturing center in Pishraneh company. His research interests include

application of computer controlled AC motors and EDM CNC machines and computer controlled switching power supplies. Dr. Rezazade currently is an assistant professor in the Power Engineering Faculty of Shahid Beheshti University. His research interests are Power system control and modeling, Industrial Control and Drives.