

# Application of Genetic Algorithm for FACTS-based Controller Design

Sidhartha Panda, N. P. Padhy, R.N.Patel

**Abstract**—In this paper, genetic algorithm (GA) optimization technique is applied to design Flexible AC Transmission System (FACTS)-based damping controllers. Two types of controller structures, namely a proportional-integral (PI) and a lead-lag (LL) are considered. The design problem of the proposed controllers is formulated as an optimization problem and GA is employed to search for optimal controller parameters. By minimizing the time-domain based objective function, in which the deviation in the oscillatory rotor speed of the generator is involved; stability performance of the system is improved. The proposed controllers are tested on a weakly connected power system subjected to different disturbances. The non-linear simulation results are presented to show the effectiveness of the proposed controller and their ability to provide efficient damping of low frequency oscillations. It is also observed that the proposed SSSC-based controllers improve greatly the voltage profile of the system under severe disturbances. Further, the dynamic performances of both the PI and LL structured FACTS-controller are analyzed at different loading conditions and under various disturbance condition as well as under unbalanced fault conditions..

**Keywords**—Genetic algorithm, proportional-integral controller, lead-lag controller, power system stability, FACTS.

## I. INTRODUCTION

RECENT development of power electronics introduces the use of flexible ac transmission system (FACTS) devices in power systems. FACTS devices are capable of controlling the network condition in a very fast manner and this feature of FACTS can be exploited to improve the stability of a power system [1]. Static synchronous series compensator (SSSC) is one of the important members of FACTS family which can be installed in series in the transmission lines. With the capability to change its reactance characteristic from capacitive to inductive, the SSSC is very effective in controlling power flow in power systems [2]. An auxiliary stabilizing signal can also be superimposed on the power flow control function of the SSSC so as to improve power system oscillation stability [3]. The applications of SSSC for power oscillation damping,

stability enhancement and frequency stabilization can be found in several references [4 -7]. The influence of degree of compensation and mode of operation of SSSC on small disturbance and transient stability is also reported in the literature [8, 9]. Most of these proposals are based on small disturbance analysis that required linearization of the system involved. However, linear methods cannot properly capture complex dynamics of the system, especially during major disturbances. This presents difficulties for tuning the FACTS-based controllers in that the controllers tuned to provide desired performance at small signal condition do not guarantee acceptable performance in the event of major disturbances. Further, unbalanced fault analysis can not be performed using the single-phase models. In order to overcome the above shortcomings, this paper uses three-phase non-linear models of SSSC and power system components.

Despite significant strides in the development of advanced control schemes over the past two decades, the classical proportional-integral-derivative (PID) controller and its variants as well as the conventional lead-lag (LL) structure controller, remain the controllers of choice in many industrial applications. These controller structures remain an engineer's preferred choice because of their structural simplicity, reliability, and the favorable ratio between performance and cost. Beyond these benefits, these controllers also offer simplified dynamic modeling, lower user-skill requirements, and minimal development effort, which are issues of substantial importance to engineering practice [10, 11].

The problem of controllers parameter tuning is a complex exercise. A number of conventional techniques have been reported in the literature pertaining to design and tuning of these controllers. Unfortunately, the conventional techniques are time consuming as they are iterative and require heavy computation burden and slow convergence. In addition, the search process is susceptible to be trapped in local minima and the solution obtained may not be optimal [12]. Genetic algorithm (GA) is becoming popular for solving the optimization problems in different fields of application, mainly because of its robustness in finding an optimal solution and ability to provide a near-optimal solution close to a global minimum. Unlike strict mathematical methods, the GA does not require the condition that the variables in the optimization problem be continuous and different; it only requires that the

Sidhartha Panda is a research scholar in the Department of Electrical Engineering, Indian Institute of Technology, Roorkee, Uttaranchal, 247667, India. (e-mail: speeddee@iitr.ernet.in, panda\_sidhartha@rediffmail.com).

N.P.Padhy is with Department of Electrical Engineering, IIT, Roorkee, and R.N.Patel is with Electrical Engineering Department of SSCET, Bhilai, India. (e-mail: nppeefee@iitr.ernet.in ramnpatel@gmail.com.)

problem to be solved can be computed. GA employs search procedures based on the mechanics of natural selection and survival of the fittest. The GAs, which use a multiple-point instead of a single-point search and work with the coded structure of variables instead of the actual variables, require only the objective function, thereby making searching for a global optimum simple [13]. The GA as an optimization technique has advantage as it adapts to irregular search space unlike other conventional techniques. The advantage of using GA is evident, as it finds its application in a number of papers for optimization problems [14, 15]. Therefore, in the present work GA is employed to search the optimal controller parameters.

In this paper, a comprehensive assessment of the effects of SSSC-based damping controller has been carried out. Two types of SSSC-based controller structure namely a proportional-integral (PI) and a LL structure are considered. The design problem of the proposed controllers is transformed into an optimization problem. The design objective is to improve the stability of a single-machine-infinite-bus (SMIB) power system, subjected to severe disturbances. GA-based optimal tuning algorithm is used to optimally tune the parameters of these controllers. The proposed controllers have been applied, tested and compared on a weakly connected power system under different severe disturbances and loading conditions and also under unbalanced fault conditions.

This paper is organized as follows. In Section II, the power system under study, which is a SMIB power system with SSSC and a brief overview of control system of SSSC, is presented. The proposed controller structures and problem formulation is described in Section III. A short overview of GA is presented in Section IV. Simulation results are provided and discussed in Section V and conclusions are given in Section VI.

## II. POWER SYSTEM UNDER STUDY

### A. Single-machine Infinite Bus Power System with SSSC

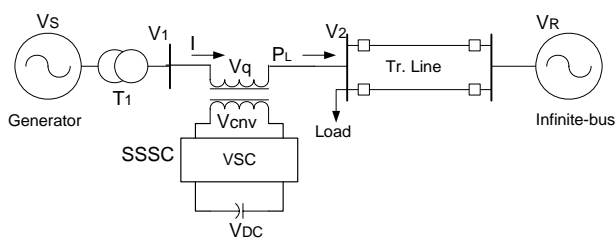

Fig. 1 Single-machine infinite bus power system with SSSC

The SMIB power system with SSSC controller, as shown in Fig. 1, is considered in this study. The system comprises a generator connected to an infinite bus through a step-up transformer and a SSSC followed by a double circuit transmission line. In the figure  $T_1$  represents the transformer;  $V_S$  and  $V_R$  are the generator terminal and infinite bus voltage respectively;  $V_1$  and  $V_2$  are the bus voltages;  $V_{DC}$  and  $V_{cnv}$

are the DC voltage source and output voltage of the SSSC converter respectively;  $I$  is the line current and  $P_L$  is the real power flow in the transmission lines

### B. Overview of SSSC and its Control System

A SSSC is a solid-state voltage source inverter, which generates a controllable AC voltage source, and connected in series to power transmission lines in a power system. The injected voltage ( $V_q$ ) is in quadrature with the line current  $I$ , and emulates an inductive or a capacitive reactance so as to influence the power flow in the transmission lines [3]. The compensation level can be controlled dynamically by changing the magnitude and polarity of  $V_q$  and the device can be operated both in capacitive and inductive mode.

The single-line block diagram of control system of SSSC is shown in Fig. 2 [15]. The control system consists of:

- A phase-locked loop (PLL) which synchronizes on the positive-sequence component of the current  $I$ . The output of the PLL ( $\theta = \omega t$ ) is used to compute the direct-axis and quadrature-axis components of the AC three-phase voltages and currents (labeled as  $V_d$ ,  $V_q$  or  $I_d$ ,  $I_q$  on the diagram).
- Measurement systems measuring the q components of AC positive-sequence of voltages  $V_1$  and  $V_2$  ( $V_{1q}$  and  $V_{2q}$ ) as well as the DC voltage  $V_{dc}$ .
- AC and DC voltage regulators which compute the two components of the converter voltage ( $V_{denv}$  and  $V_{qenv}$ ) required to obtain the desired DC voltage ( $V_{dcref}$ ) and the injected voltage ( $V_{qref}$ ).

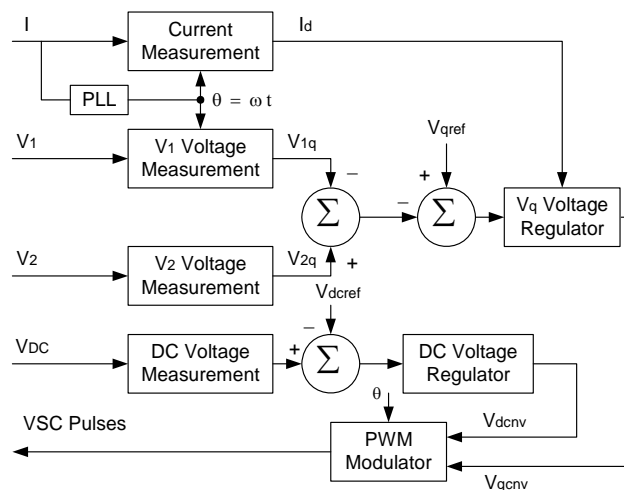

Fig. 2 Single line diagram of the control system of SSSC

The variation of injected voltage is performed by means of a Voltage-Sourced Converter (VSC) connected on the secondary side of a coupling transformer. The VSC uses forced-commutated power electronic devices (e.g. GTOs, IGBTs or IGCTs) to synthesize a voltage  $V_{cnv}$  from a DC voltage source. A capacitor connected on the DC side of the VSC acts as a DC voltage source. In the control system block diagram  $V_{denv}$  and  $V_{qenv}$  designate the components of converter

voltage  $V_{cnv}$  which are respectively in phase and in quadrature with line current  $I$ . VSC using IGBT-based PWM inverters is used in the present study. However, as details of the inverter and harmonics are not represented in power system stability studies, a GTO-based model can also be used. This type of inverter uses Pulse-Width Modulation (PWM) technique to synthesize a sinusoidal waveform from a DC voltage with a typical chopping frequency of a few kilohertz. Harmonics are cancelled by connecting filters at the AC side of the VSC. This type of VSC uses a fixed DC voltage  $V_{dc}$ . The converter voltage  $V_{cnv}$  is varied by changing the modulation index of the PWM modulator.

### III. THE PROPOSED APPROACH

#### A. Structure of the PI and LL Controller

The PI control scheme chosen in the present study is a variant of PID control scheme with the derivative (D) coefficient set equal to zero. A derivative coefficient is not essential and may have a detrimental effect on system response characteristics [10]. The PI and LL structures of SSSC-based damping controller, to modulate the SSSC injected voltage  $V_q$ , are shown in Figs. 3 and 4 respectively.

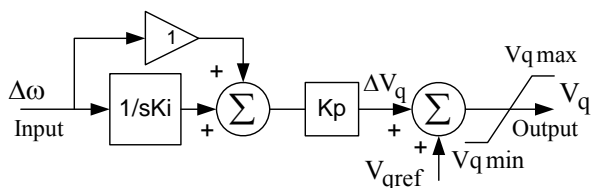

Fig. 3 PI structure of SSSC-based controller

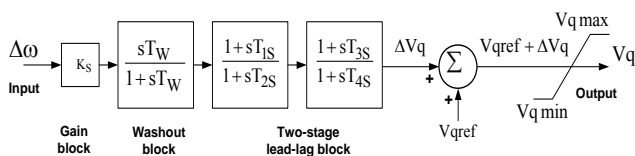

Fig. 4 Lead-lag structure of SSSC-based controller

The input signal of the proposed controllers is the speed deviation ( $\Delta\omega$ ), and the output signal is the injected voltage  $V_q$ . The integral and proportional parameters of the PI controller are  $K_i$  and  $K_p$ , respectively. The LL controller consists of a gain block with gain  $K_s$ , a signal washout block and two-stage phase compensation blocks. The signal washout block serves as a high-pass filter, with the time constant  $T_w$ , high enough to allow signals associated with oscillations in input signal to pass unchanged. From the viewpoint of the washout function, the value of  $T_w$  is not critical and may be in the range of 1 to 20 seconds. The phase compensation block (time constants  $T_{1S}$ ,  $T_{2S}$  and  $T_{3S}$ ,  $T_{4S}$ ) provides the appropriate phase-lead characteristics to compensate for the phase lag between input and the output signals. In the Figs. 3 and 4,  $V_{qref}$  represents the reference injected voltage as desired by the steady state power flow control loop. The steady state power

flow loop acts quite slowly in practice and hence, in the present study,  $V_{qref}$  is assumed to be constant during large disturbance transient period. The desired value of compensation is obtained according to the change in the SSSC injected voltage  $\Delta V_q$  which is added to  $V_{qref}$ .

#### B. Problem Formulation

In case of PI controller, the parameters  $K_i$  and  $K_p$  are to be determined. In case of LL controller, the washout time constants  $T_w$  and the time constants  $T_{2S}$ ,  $T_{4S}$  are usually prespecified. In the present study,  $T_w=10s$  and  $T_{2S} = T_{4S} = 0.3 s$  are used. The controller gain  $K_s$  and the time constants  $T_{1S}$  and  $T_{3S}$  are to be determined. During steady state conditions  $\Delta V_q$  and  $V_{qref}$  is constant. During dynamic conditions the series injected voltage  $V_q$  is modulated to damp system oscillations. The effective  $V_q$  in dynamic conditions is:

$$V_q = V_{qref} + \Delta V_q \quad (1)$$

It is worth mentioning that the SSSC-based controllers are designed to minimize the power system oscillations after a large disturbance so as to improve the power system stability. These oscillations are reflected in the deviations in power angle, rotor speed and line power. Minimization of any one or all of the above deviations could be chosen as the objective. In the present study, an integral time absolute error of the speed deviations is taken as the objective function expressed as follows:

$$J = \int_{t=0}^{t=t_{sim}} [ |\Delta\omega| ] \cdot t \cdot dt \quad (2)$$

In the above equations,  $\Delta\omega$  denotes the rotor speed deviation for a set of controller parameters (note that here the controller parameters represent the parameters to be optimized;  $K_i$  &  $K_p$ ; the parameters of PI controller and  $K_s$ ,  $T_{1S}$ ,  $T_{3S}$ ; the parameters of the LL controller), and  $t_{sim}$  is the time range of the simulation. For objective function calculation, the time-domain simulation of the power system model is carried out for the simulation period. It is aimed to minimize this objective function in order to improve the system response in terms of the settling time and overshoots.

### IV. OVERVIEW OF GENETIC ALGORITHM (GA)

GA has been used for optimizing the parameters of the control system that are complex and difficult to solve by conventional optimisation methods. GA maintains a set of candidate solutions called population and repeatedly modifies them. At each step, the GA selects individuals from the current population to be parents and uses them to produce the children for the next generation. Candidate solutions are usually represented as strings of fixed length, called chromosomes. A fitness or objective function is used to reflect the goodness of each member of the population. Given a random initial population, GA operates in cycles called generations, as follows:

- Each member of the population is evaluated using a fitness function.
- The population undergoes reproduction in a number of

iterations. One or more parents are chosen stochastically, but strings with higher fitness values have higher probability of contributing an offspring.

- Genetic operators, such as crossover and mutation, are applied to parents to produce offspring.
- The offspring are inserted into the population and the process is repeated.

Tuning a controller parameter can be viewed as an optimization problem in multi-modal space as many settings of the controller could be yielding good performance. Traditional method of tuning doesn't guarantee optimal parameters and in most cases the tuned parameters needs improvement through trial and error. In GA based method, the tuning process is associated with an optimality concept through the defined objective function and the time domain simulation. The designer has the freedom to explicitly specify the required performance objectives in terms of time domain bounds on the closed loop responses. Hence the GA methods yield optimal parameters and the method is free from the curse of local optimality. In view of the above, the proposed approach employs GA to solve this optimization problem and search for optimal set of SSSC-based damping controller parameters.

The fitness function comes from time-domain simulation of power system model. Using each set of controllers' parameters, the time-domain simulation is performed and the fitness value is determined. Good solutions are selected, and by means of the GA operators, new and better solutions are

number of parameters are required to be specified. An appropriate choice of these parameters affects the speed of convergence of the algorithm. For different problems, it is possible that the same parameters for GA do not give the best solution, and so these can be changed according to the situation. One more important point that affects the optimal solution more or less is the range for unknowns. For the very first execution of the programme, a wider solution space can be given and after getting the solution one can shorten the solution space nearer to the values obtained in the previous iteration. The computational flowchart of the proposed design approach is shown in Fig. 5.

## V. RESULTS AND DISCUSSIONS

The SimPowerSystems (SPS) toolbox is used for all simulations and SSSC-based damping controller design. SPS is a MATLAB-based modern design tool that allows the user to rapidly and easily build models to simulate power systems using simulink environment. The SPS main library 'powerlib' contains models of typical power system components such as machines, governors, excitation systems, transformers, lines and FACTS devices. The library also contains the 'powergui' block that opens a graphical user interface for the steady-state analysis of electrical circuits. The load flow and machine initialization option of the 'powergui' block performs the load flow and the machine initialization [16]. In order to optimally tune the parameters of the SSSC-based damping controller, as well as to assess its performance and robustness under wide range of operating conditions with various fault disturbances and fault clearing sequences, the test system depicted in Fig. 1 is considered for analysis. The model of the example power system shown in Fig. 1 is developed using SPS blockset. The system consists of a of 2100 MVA, 13.8 kV, 60Hz hydraulic generating unit, connected to a 300 km long double-circuit transmission line through a 3-phase 13.8/500 kV step-up transformer and a 100 MVA SSSC. The generator is equipped with hydraulic turbine & governor (HTG) and excitation system. All the relevant parameters are given in appendix.

### A. Application of GA Optimization Technique

For the purpose of optimization of Eq. (2), routines from genetic algorithm for optimization toolbox (GOAT) [17] is used. The objective function is evaluated for each individual by simulating the example power system, considering a severe disturbance. For objective function calculation nominal operating condition is considered with  $P_e = 0.8$  pu and  $\delta_0 = 48.48^\circ$ . A 3-phase short-circuit fault in one of the parallel transmission lines is considered and objective function is minimized by means of GA. The normalized geometric ranking, which is one of the ranking methods, is used as a selection function to select individuals in the population for the next generations. Also, arithmetic crossover as the crossover function and non-uniform mutation as mutation operators are adopted. In Table I the parameters for GAOT optimization routines are given. The description of these operators and their properties can be found in the work of

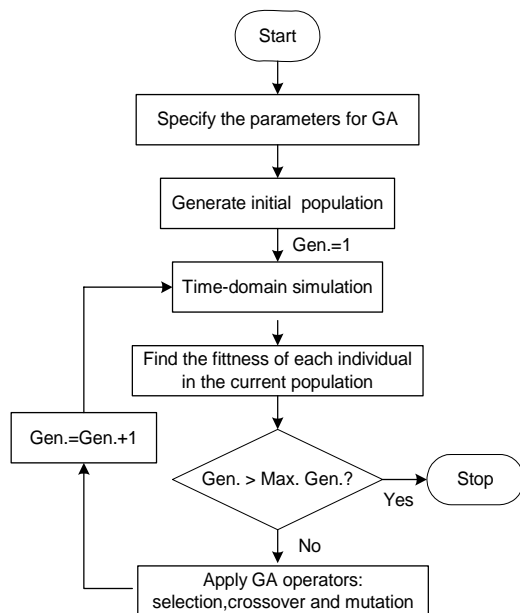

Fig. 5 Flowchart of the genetic algorithm

achieved. This procedure continues until a desired termination criterion is achieved. Although the chances of GA giving a local optimal solution are very few, sometimes getting a suboptimal solution is also possible. While applying GA, a

Houck et al. [17]. Optimization is terminated by the prespecified number of generations. Optimization is performed with the total number of generations set to 50. The optimal values of PI and LL controller parameters obtained by the GA optimization technique are:  $K_i = 0.2050$ ,  $K_p = 47.6179$  and  $K_s = 76.06$ ,  $T_{1S} = 0.5923$ ;  $T_{3S} = 0.1463$  respectively.

TABLE I  
 PARAMETERS USED IN GENETIC ALGORITHM

Parameter	Value/Type
Maximum generations	100
Population size	50
Type of selection	Normal geometric [0 0.08]
Type of crossover	Arithmetic [2]
Type of mutation	Nonuniform [2 100 3]
Termination method	Maximum generation

### B. Simulation Results

To assess the effectiveness and robustness of the proposed controllers, simulation studies are carried out for various fault disturbances and fault clearing sequences. The behavior of the proposed controller under transient conditions is verified by applying various types of disturbances under different operating conditions. In the figures, the response without control (no control) and responses with GA optimized PI and LL SSSC-based controllers are shown with legends NC, GAPI and GALL respectively. The following cases are considered:

#### Case I: Nominal loading:

A 3-phase fault is applied at the nominal operating conditions ( $P_e = 0.8$  pu,  $\delta_0 = 48.48^\circ$ ), at the middle of the one transmission line at  $t = 1$  sec. The fault is cleared after 5-cycles and the original system is restored after the fault clearance. The system power angle response under this severe disturbance is shown in Fig. 6. It is clear from the figure that, the system is unstable without control under this disturbance. Stability of the system is maintained and the first swing in rotor angle is significantly reduced with the application of proposed GAPI and GALL controllers. Hence, the proposed controllers extend the power system stability limit and the power transfer capability. It is also clear from the figure that, the performance of GALL is slightly better than that of GAPI. The responses of speed deviation, line power flow, terminal voltage and injected voltage by SSSC controllers, for both the control structures are shown in Figs. 7-10. It is clear from these figures that the proposed controllers provide good damping characteristics to low frequency oscillations and stabilizes the system voltage in the event of major disturbance.

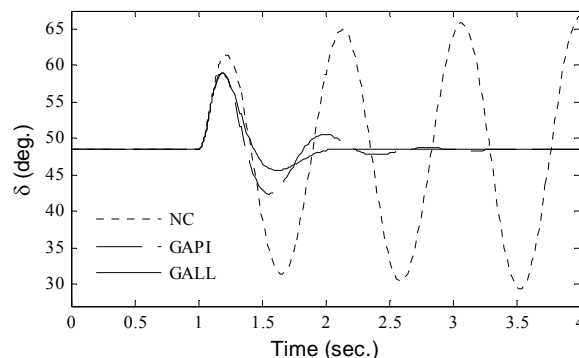

Fig. 6 Response of power angle for a 5-cycle 3-phase fault disturbance at nominal loading condition

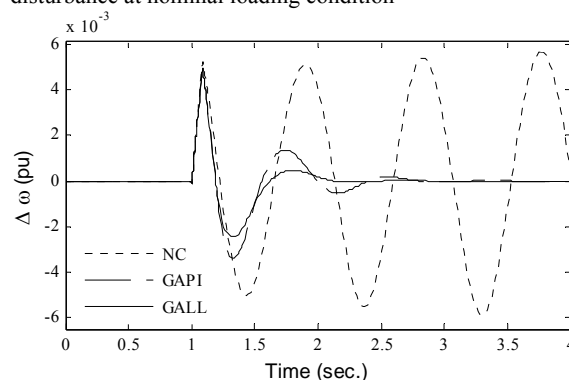

Fig. 7 Response of speed deviation for a 5-cycle 3-phase fault disturbance at nominal loading condition

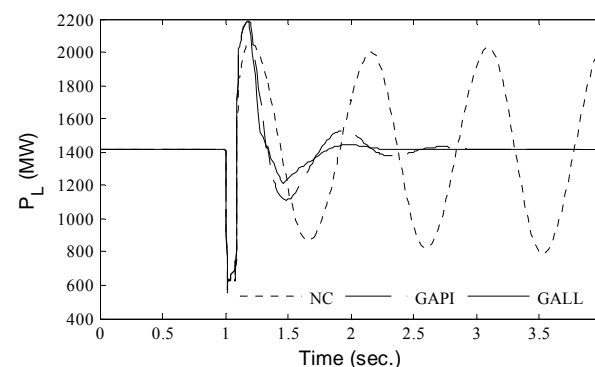

Fig. 8 Response of line power flow for a 5-cycle 3-phase fault disturbance at nominal loading condition

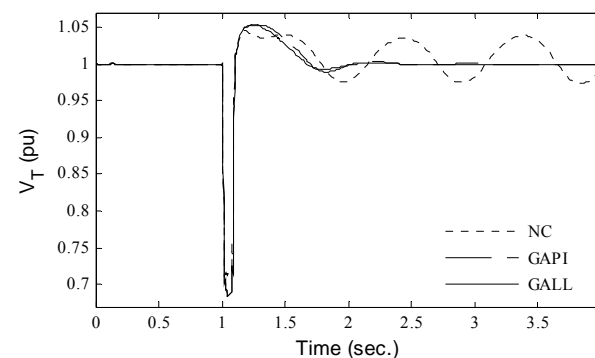

Fig. 9 Response of terminal voltage for a 5-cycle 3-phase fault disturbance at nominal loading condition

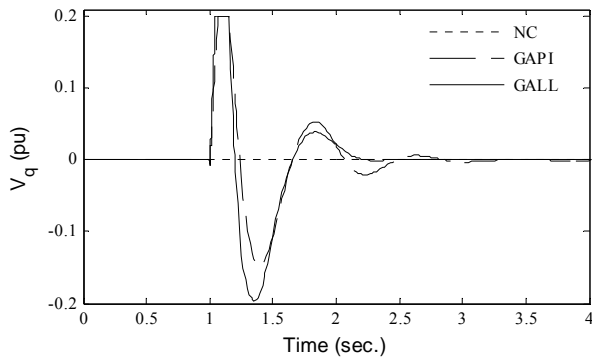

Fig. 10 Variation of SSSC injected voltage for a 5-cycle 3-phase fault disturbance at nominal loading condition

**Case II: Light loading:**

To test the robustness of the controller to operating condition and location of the fault, the generator loading is changed to light loading condition ( $P_e = 0.4$  pu,  $\delta_0 = 22.9^\circ$ ), and a 5-cycle, 3-phase fault is applied at Bus3. The fault is cleared by opening both the lines. One of the lines is reclosed after 5-cycles and the other is reclosed after 5 sec. The system speed deviation response to this disturbance is shown in Fig. 11. It can be seen from the figure that, without control, the system is highly oscillatory under the above contingency. The proposed controllers quickly stabilize the power system oscillations. However, the performance of the GALL is much better than that of GAPI. Critical examination of the speed deviation responses shown in Figs. 7 and 11, indicates that the dynamic performance of the PI controller deteriorates further compared to the LL controller. This indicates that at the off-nominal operating conditions, the performance of the PI controller tuned at the nominal operating conditions deteriorates, whereas the LL controller performance is similar at all the operating conditions.

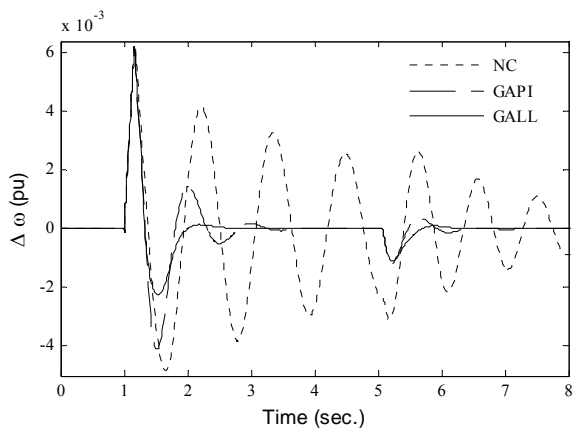

Fig. 11 Response of speed deviation for a 5-cycle 3-phase fault disturbance at Bus 3 followed by line tripping at light loading condition

**Case III: Heavy loading:**

The robustness of the proposed controllers is also tested at heavy loading condition ( $P_e = 0.4$  pu,  $\delta_0 = 60.7^\circ$ ). Fig. 12

shows the system speed deviation response for a 3-cycle, 3-phase fault at middle of the one transmission line and cleared by permanent tripping of the faulted line. It can be clearly seen from Fig. 12 that, for the given operating condition and contingency, the system is first swing unstable without control. With the application of GAPI, even though the system is first swing stable, the power system oscillations are sustained and continued to grow resulting in loss of stability. Stability of the system is maintained and power system oscillations are rapidly stabilized with GALL. This confirms that the performance of PI controller tuned at nominal operating conditions deteriorates at the non-nominal operating conditions and the LL controller is robust to operating conditions and fault locations.

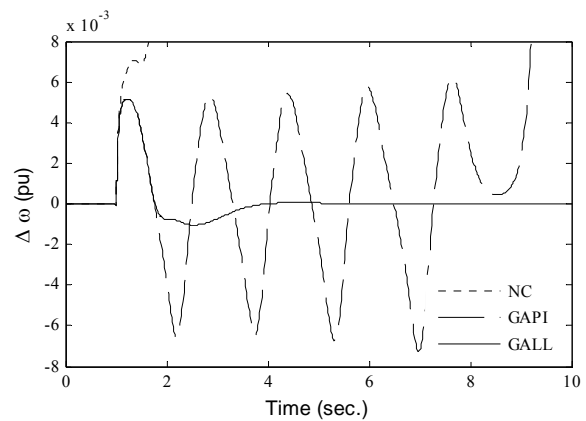

Fig. 12 Response of speed deviation for a 3-cycle 3-phase fault disturbance at middle of line followed permanent tripping of faulted line at heavy loading condition

**Case IV: Small disturbance:**

In order to examine the effectiveness of the proposed controllers under small disturbance, the load at Bus2 is disconnected at  $t = 1$  sec for 50 ms. The speed deviation response with PI structure SSSC controller for the three loading conditions mentioned above is shown in Fig. 13.

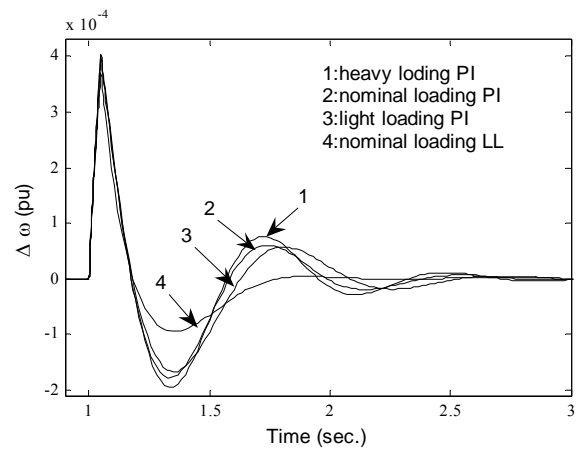

Fig. 13 Response of speed deviation for a small disturbance at Bus 2

The response with LL controller at the nominal operating conditions is also shown in the Fig. 13. Under small disturbance and for different operating conditions, the performance of the LL controller is almost similar and hence only one response is shown in the figure. It is also clear from the Fig. 13 that, for small disturbance conditions, the dynamic performance of the PI controller is quiet robust and the performance almost similar at all the operating conditions.

**Case V: Unbalanced faults:**

The effectiveness of the proposed controllers to unbalanced faults is also examined by applying different types of unbalanced faults, namely double line-to-ground (LLG) and single-line-to-ground (LG), near Bus3. The duration of each unbalanced fault is assumed to be of 10-cycles, and the original system is restored after the clearance of the fault. The system speed deviation response for the above contingencies is shown in Fig. 14, which also shows the uncontrolled response for the least severe fault i.e. LG fault. It is clear from the figure that, the system is unstable for the least severe LG fault and the proposed controllers maintain the stability of the system and also stabilizes the oscillations quickly. Further, it can be seen from figure that the dynamic performance of both the proposed controllers are almost similar under unbalanced fault conditions.

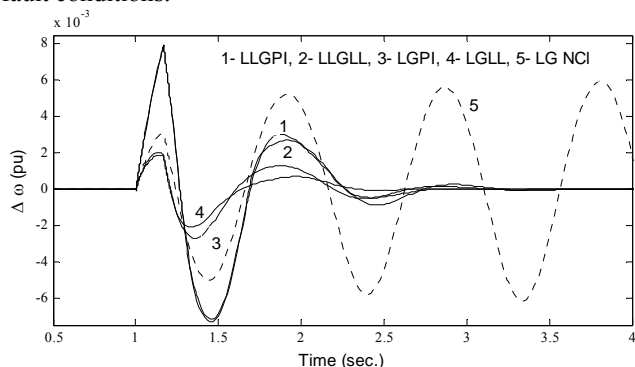

Fig. 14 Response of speed deviation for unbalanced faults at Bus 3

**VI. CONCLUSION**

In this paper, power system stability enhancement by SSSC-based damping controllers is presented. Both PI and LL controller structures are considered in the present work. For the proposed controllers design problem, a non-linear simulation-based objective function to increase the system damping was developed. Then, the genetic algorithm optimization technique is implemented to search for the optimal controllers parameters. The effectiveness of the both the proposed SSSC-based damping controllers, for power system stability improvement, are demonstrated by a weakly connected example power system subjected to different severe disturbances. The non-linear simulation results show the effectiveness of the proposed controllers and their ability to provide good damping of low frequency oscillations and to improve the system voltage profile. It is observed that, the dynamic performance of the PI controller at the nominal operating conditions is satisfactory and compares well with the LL controller. However, the dynamic performance of PI

controller deteriorates as the operating conditions and fault locations change. The GA optimized LL SSSC-based controller is found to be robust and ensure stability of power system at different operating conditions. However, the dynamic performances of both the proposed PI and LL controllers are robust to loading conditions under small disturbance and almost similar under unbalanced fault conditions.

**APPENDIX**

A complete list of parameters used appears in the default options of SimPowerSystems in the User's Manual [15]. All data are in pu unless specified otherwise.

- 1) **Generator**  
 $S_B = 2100 \text{ MVA}$ ,  $H = 3.7 \text{ s}$ ,  $V_B = 13.8 \text{ kV}$ ,  $f = 60 \text{ Hz}$ ,  
 $P_{co} = 0.75$ ,  $V_{to} = 1.0$ ,  $\delta_o = 41.51^\circ$ ,  $R_S = 2.8544 \text{ e-}3$ ,  $X_d = 1.305$ ,  $X_d' = 0.296$ ,  $X_d'' = 0.252$ ,  $X_q = 0.474$ ,  $X_q' = 0.243$ ,  $X_q'' = 0.18$ ,  $T_d = 1.01 \text{ s}$ ,  $T_d' = 0.053 \text{ s}$ ,  $T_{qo} = 0.1 \text{ s}$ .
- 2) **Hydraulic Turbine and Governor**  
 $K_a = 3.33$ ,  $T_a = 0.07$ ,  $G_{min} = 0.01$ ,  $G_{max} = 0.97518$ ,  $V_{gmin} = -0.1 \text{ pu/s}$ ,  $V_{gmax} = 0.1 \text{ pu/s}$ ,  $R_p = 0.05$ ,  $K_p = 1.163$ ,  
 $K_i = 0.105$ ,  $K_d = 0$ ,  $T_d = 0.01 \text{ s}$ ,  $\beta = 0$ ,  $T_w = 2.67 \text{ s}$
- 3) **Excitation System**  
 $T_{LP} = 0.02 \text{ s}$ ,  $K_a = 200$ ,  $T_a = 0.001 \text{ s}$ ,  $K_e = 1$ ,  $T_e = 0$ ,  $T_b = 0$ ,  $T_c = 0$ ,  $K_f = 0.001$ ,  $T_f = 0.1 \text{ s}$ ,  $E_{fmin} = 0$ ,  $E_{fmax} = 7$ ,  $K_p = 0$
- 4) **Transformer**  
 $2100 \text{ MVA}$ ,  $13.8/500 \text{ kV}$ ,  $60 \text{ Hz}$ ,  $R_1 = 0.002$ ,  $L_1 = 0$ ,  
 $D_1/Y_g$  connection,  $R_m = 500$ ,  $L_m = 500$
- 5) **Transmission line**  
 $3\text{-Ph}$ ,  $60 \text{ Hz}$ ,  $\text{Length} = 300 \text{ km}$  each,  $R_1 = 0.02546 \text{ } \Omega/\text{km}$ ,  
 $R_0 = 0.3864 \text{ } \Omega/\text{km}$ ,  $L_1 = 0.9337 \text{ e-}3 \text{ H/km}$ ,  $L_0 = 4.1264 \text{ e-}3 \text{ H/km}$ ,  
 $C_1 = 12.74 \text{ e-}9 \text{ F/km}$ ,  $C_0 = 7.751 \text{ e-}9 \text{ F/km}$
- 6) **SSSC**  
 $S_{nom} = 100 \text{ MVA}$ ,  $V_{nom} = 500 \text{ kV}$ ,  $f = 60 \text{ Hz}$ ,  
 $V_{qmax} = 0.2$ ,  $\text{Max rate of change of } V_{qref} = 3/\text{s}$ ,  $R_{cnv} = 0.00533$ ,  
 $L_{cnv} = 0.16$ ,  $V_{DC} = 40 \text{ kV}$ ,  $C_{DC} = 375 \text{ e-}6 \text{ F}$ ,  
 $K_{P\_IVR} = 0.00375$ ,  $K_{I\_IVR} = 0.1875$ ,  $K_{P\_VdcR} = 0.1 \text{ e-}3$ ,  
 $K_{I\_VdcR} = 20 \text{ e-}3$

**REFERENCES**

- [1] N. G. Hingorani and L. Gyugyi, "Understanding FACTS: concepts and technology of flexible AC transmission systems", IEEE Press, New York, 2000.
- [2] L. Gyugyi, C. D. Schauder and K. K. Sen, "Static synchronous series compensator: a solid-state approach to the series compensation of transmission lines," *IEEE Transactions on Power Delivery*, vol. 12, no. 1, pp. 406-17, Jan. 1997.
- [3] H. F. Wang, "Static synchronous series compensator to damp power system oscillations," *Electric Power Systems Research*, vol. 54, pp. 113-119, 2000.
- [4] R. Mihalic and I. Papic, "Static synchronous series compensator—a mean for dynamic power flow control in electric power systems," *Electric Power Systems Research*, vol. 45, pp. 65–72, 1998.

- [5] D. Menniti, A. Pinnarelli, N. Scordino and N. Sorrentino, "Using a FACTS device controlled by a decentralised control law to damp the transient frequency deviation in a deregulated electric power system," *Electric Power Systems Research*, vol. 72 pp. 289–298, 2004.
- [6] I. Ngamroo, J. Tippayachai and S. Dechanupaprittha, "Robust decentralised frequency stabilisers design of static synchronous series compensators by taking system uncertainties into consideration," *Electrical Power and Energy Systems* vol. 28, pp. 513–524, 2006.
- [7] F. A. R. Al Jowder and B. T. Ooi, "Series Compensation of Radial Power System by a Combination of SSSC and Dielectric Capacitors," *IEEE Transactions on Power Delivery*, vol. 20, no. 1, pp., pp458-465, January 2005.
- [8] F. A. R. Al Jowder, "Influence of Mode of Operation of the SSSC on the Small Disturbance and Transient Stability of a Radial Power System," *IEEE Transactions on Power Systems*, vol. 20, no. 2, pp935-942, May 2005.
- [9] M.S. Castro, H.M. Ayres, V.F. da Costa and L.C.P. da Silva, "Impacts of the SSSC control modes on small-signal transient stability of a power system," *Electric Power Systems Research*, vol. 77, pp. 1–9, 2007.
- [10] Available: <http://www.control-innovation.com/>
- [11] Y.L. Abdel-Magid, M.A. Abido, "Coordinated design of a PSS and a SVC-based controller to enhance power system stability. *Electrical Power & Energy Syst*, vol. 25, pp. 695-704, 2003.
- [12] Y.L. Abdel-Magid and M.A. Abido, "Robust coordinated design of excitation and TCSC-based stabilizers using genetic algorithms, *International Journal of Electrical Power & Energy Systems*, vol. 69, no. 2-3, pp. 129-141. 2004.
- [13] D. E. Goldberg, *Genetic Algorithms in Search, Optimization and Machine Learning*. Addison-Wesley, 1989.
- [14] S. Mishra, P.K. Dash, P.K. Hota and M. Tripathy, "Genetically optimized neuro-fuzzy IPFC for damping modal oscillations of power system." *IEEE Trans. Power Syst.*, vol-17, pp. 1140–1147, 2002.
- [15] M.A. Abido, "Analysis and assessment of STATCOM-based damping stabilizers for power system stability enhancement," *Electric Power Systems Research*, vol. 73, pp. 177–185, 2005.
- [16] SimPowerSystems 4.3 User's Guide. Available: <http://www.mathworks.com/products/simpower/>
- [17] C. Houck, J. Joines and M. Kay, *A genetic algorithm for function optimization: A MTLAM implementation*. NCSU-IE, TR 95–09. 1995. Available: <http://www.ise.ncsu.edu/mirage/GAToolBox/gaot>

**Sidhartha Panda** received the M.E. degree in Power Systems Engineering from University College of Engineering, Burla, Sambalpur University, India in 2001. Currently, he is a Research Scholar in Electrical Engineering Department of Indian Institute of Technology Roorkee, India. He was an Associate Professor in the Department of Electrical and Electronics Engineering, VITAM College of Engineering, Andhra Pradesh, India and Lecturer in the Department of Electrical Engineering, SMIT, Orissa, India. His areas of research include power system transient stability, power system dynamic stability, FACTS, optimization techniques, distributed generation and wind energy.

**Narayana Prasad Padhy** received the electrical engineering degree and Master's degrees in power systems engineering (with distinction) in 1990 and 1993, respectively, from the Institution of Engineers, Calcutta and Thiagarajar College of Engineering, Madurai, Tamilnadu, India, and the Ph.D. degree in electrical engineering from Anna University, Chennai, India. He joined Birla Institute of Technology and Science (BITS) as Assistant Professor in Electrical Engineering Department in 1997. He is presently an Associate Professor in the Department of Electrical Engineering, Indian Institute of Technology, Roorkee (IITR), India. His fields of interest include power system privatization, restructuring, and deregulation, artificial intelligence applications to power system operation and optimization problems, unit commitment, power system wheeling, and FACTS.

**R. N. Patel** is working as a faculty in the Electrical Engineering Department of SSCET, Bhilai. Prior to this he has worked for BITS Pilani and Indian

Institute of Technology Roorkee, India. He received his Ph.D. degree from Indian Institute of Technology, Delhi in the year 2003. He has published many papers in reputed international journals and conferences. His main research interests are in the areas of power system transient stability, power system dynamics and optimization, application of intelligent controls and modeling & simulation.