

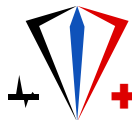

## Project Deliverable

<b>Project Number:</b> 325275	<b>Project Acronym:</b> SAPPHIRE	<b>Project Title:</b> System Automation of PEMFCs with Prognostics and Health management for Improved Reliability and Economy
<b>Instrument:</b> Collaborative Project (CP)		<b>Thematic Priority:</b> Fuel Cells and Hydrogen Joint Undertaking
<b>Title:</b> <b>Characterization and measurement techniques (update D2.4)</b>		
<b>Contractual Delivery Date:</b> April 30, 2016		<b>Actual Delivery Date:</b> May 18, 2016
<b>Start Date of the Project:</b> May 1, 2013		<b>Duration:</b> 36 months
<b>Organisation name of lead contractor for this deliverable:</b> FCLAB		<b>Document Version:</b> 1.0
<b>Organisation notes:</b>		

Dissemination level (Project co-funded by the European Commission within the Seventh Framework Programme)		
<b>PU</b>	Public	<b>PU</b>  Public
<b>PP</b>	Restricted to other programme participants (including the Commission)	
<b>RE</b>	Restricted to a group defined by the consortium (including the Commission)	
<b>CO</b>	Confidential, only for members of the consortium (including the Commission)	

**Authors (organisations):**

Elodie Lechartier (FCLAB)

**Abstract:**

Performing FC characterizations (polarization curves and EIS) can be time consuming and even impossible (according to the type of application). Thereby, it can be critical for an online implementation of the PHM-aware controller. According to that, the aim of this deliverable is to discuss the opportunity of reducing this step by assessing the performances of the prognostics approach described in D6.2 if available data are reduced, i.e. if only few points from characterization procedures are used as for parameters initialization and updating.

**Keywords:**

Data, Characterization, Prediction, Specification, Prognostics, EIS, Polarization curve

## Revision History

Rev.	Date	Description	Author (organisation)
1.0	2015/04/04	First version	Elodie Lechartier (FCLAB)
1.0	2015/05/18	Last version	Elodie Lechartier (FCLAB)



## Table of Contents

<b>1</b>	<b>Recall of the model</b>	<b>5</b>
<b>2</b>	<b>Problematic and process</b>	<b>6</b>
2.1	Objective . . . . .	6
2.2	Process . . . . .	7
<b>3</b>	<b>Test A: Reduction of the number of points for each characterization</b>	<b>7</b>
3.1	Reduction of the number of points . . . . .	7
3.2	Updating procedure . . . . .	8
3.3	Behavior prediction . . . . .	9
<b>4</b>	<b>Test B: reduction of the number of points after the first characterization</b>	<b>9</b>
4.1	Reduction of the number of points . . . . .	9
4.2	Updating procedure . . . . .	10
4.3	Behavior prediction . . . . .	10
<b>5</b>	<b>Synthesis</b>	<b>11</b>

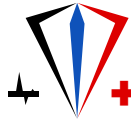

## Nomenclature

$\eta_a$	Voltage drop at the anode	[V]
$\eta_c$	Voltage drop at the cathode	[V]
$\tau_{Oc}$	Time constant of the diffusion convection impedance	[s]
$b_a$	Tafel anode parameter	[V <sup>-1</sup> ]
$b_c$	Tafel cathode parameter	[V <sup>-1</sup> ]
$b_{Oc}$	Parameter of the variation law of $R_{Oc}$	[V <sup>-1</sup> ]
$C_{dca}$	Double layer capacity at the anode	[F/cm <sup>2</sup> ]
$C_{dcc}$	Double layer capacity at the cathode	[F/cm <sup>2</sup> ]
$E_n$	Nernst Potential	[V]
$i$	Number of EIS realized at each characterizations	
$j_{0a}$	Exchange current density at the anode	[A/cm <sup>2</sup> ]
$j_{0c}$	Exchange current density at the cathode	[A/cm <sup>2</sup> ]
$j_{0Oc}$	Parameter of the variation law of $R_{Oc}$	[A/cm <sup>2</sup> ]
$J_{AC}$	Dynamic current density	[A/cm <sup>2</sup> ]
$J_{DC}$	Static current density	[A/cm <sup>2</sup> ]
$j_{Lc}$	Limit current density at the cathode	[A/cm <sup>2</sup> ]
$k$	Number of characterizations	
$k_{Oc}$	Parameter of the variation law of $\tau_{Oc}$	[A.s/cm <sup>2</sup> ]
$L$	Connectors' inductance	[H.cm <sup>2</sup> ]
$R_m$	Internal resistance	[ $\Omega$ .cm <sup>2</sup> ]
$R_{Oc}$	Module of the diffusion convection impedance	[ $\Omega$ .cm <sup>2</sup> ]
$R_{ta}$	Transfer resistance at the anode	[ $\Omega$ .cm <sup>2</sup> ]
$R_{tc}$	Transfer resistance at the cathode	[ $\Omega$ .cm <sup>2</sup> ]
$U$	Stack Voltage	[V]
$U_{AC}$	Dynamic stack Voltage normalized per cell	[V]
$U_{DC}$	Static stack Voltage normalized per cell	[V]
$U_n$	Stack voltage normalized per cell	[V]
$W_{Oc}$	Diffusion convection impedance	[ $\Omega$ .cm <sup>2</sup> ]

## 1 Recall of the model

In this section is presented a quick recall of the model used for the hybrid prognostics approach. More details and a complete description can be found in [1] and D6.1.

The input of this model is the current which is normalized as current density to be decomposed in alternative and continuous parts. These two current densities are the input of the static and dynamic models. The outputs of these models are recomposed in voltage per cell to finally be de normalized in voltage (Figure 1).

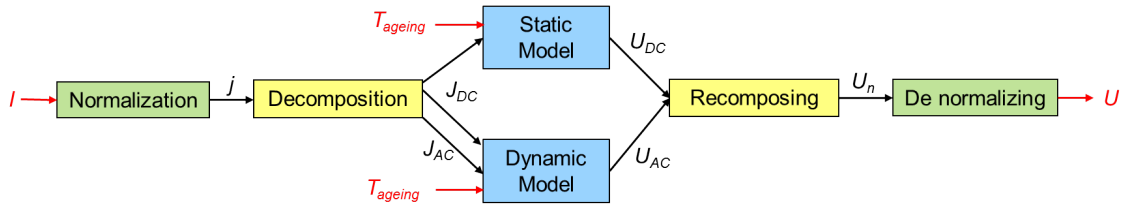

Figure 1: Scheme of the model

The aim of the dynamic part of the model is to link voltage variations with the current variation around a static operating point. This part of the model is based on an electrical equivalency. Indeed, the physical phenomena are represented by an impedance (Figure 2).

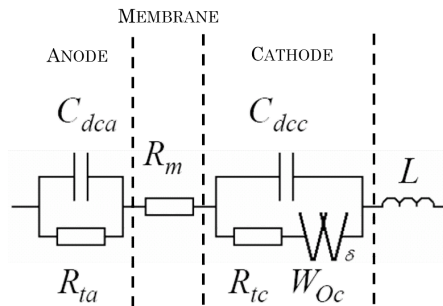

Figure 2: Electrical equivalency impedance of the dynamic model

The static part is based on a development of the Butler Volmer law with a difference made between the electrodes (eq. (1)) :

$$U_{DC} = E_n - R_m \cdot J_{DC} - \frac{1}{b_a} \cdot \operatorname{asinh} \left( \frac{J_{DC}}{2 \cdot j_{0a}} \right) - \frac{1}{b_c} \cdot \operatorname{asinh} \left( \frac{J_{DC}}{2 \cdot j_{0c} \cdot \left( 1 - \frac{J_{DC}}{j_{Lc}} \right)} \right) \quad (1)$$

The time is included in the model (Figure 1). The process realized for adding a time dependency is described on the figure 3, and on the following.

First, thanks to a characterization (composed of EISs and one polarization curve), the values of the parameters can be obtained for the time considered with the updating procedure (Figure

3). It is realized on all the characterizations learnt. Then exponential models are obtained with an identification thanks to the parameters values.

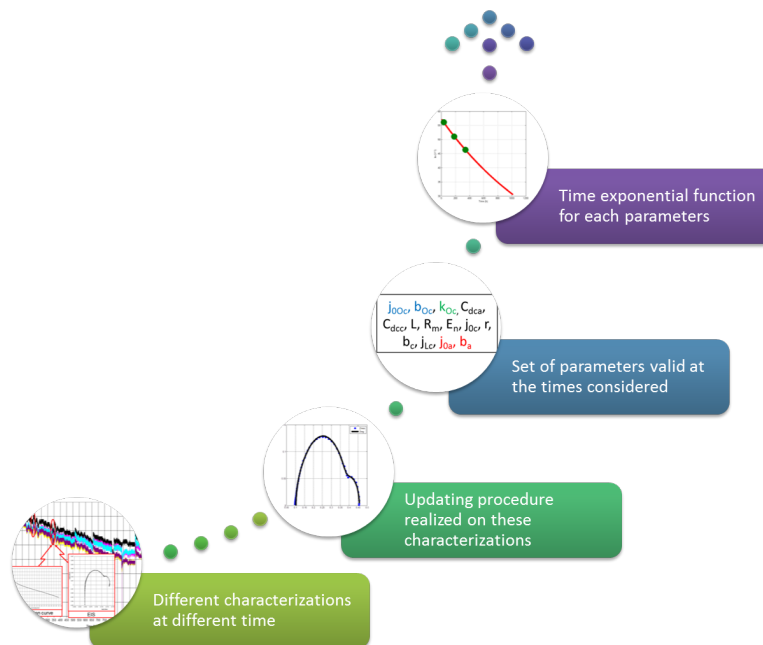

Figure 3: Process for initializing the ageing model

The parameters that are chosen as evolving with the time (cf. D6.2) are modeled by an exponential function (eq. (2)).

$$Param(t) = \alpha \cdot e^{\beta \cdot t} \quad (2)$$

Where, both parameters ( $\alpha, \beta$ ) are identified by a fitting with of the expression (eq. (2)) and the values obtained from the experimentation.

## 2 Problematic and process

### 2.1 Objective

The goal of this deliverable is to specify the minimal amount of data the prognostics approach proposed in the D6.2 needs. Indeed, performing characterizations is time consuming and even partly not realized on the system. Here, we discuss the opportunity of reducing this step of characterization by assessing the performances of the prognostics approach described in D6.2 if available data are reduced.

Thus, in the D6.2 the use of the approach is validated, but we would like to go further. Indeed, in the frame of SAPPHIRE the measure of EIS on the system was not possible. However, it would be preferable. In this deliverable, the reduction of the number of points for the EIS measurement is studied.

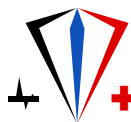

For an online implementation on an industrial system, the realization of the characterization should be as fast as possible. For that purpose, the number of points measured should be reduced. In the following document, the term "point" should be a point of measurement for an EIS and / or polarization curve.

## 2.2 Process

The data used here is the Exp. 2, realized by ZSW during the project. A 5-cell stack was cycled with one cycle per day based on a  $\square$ CHP profile. The characterization measurement was not homogeneous for the two first characterizations. This implies that they are not usable here, as not comparable. The first characterization we can use is the one realized after 620h of trial, the third one.

Different tests have been realized:

- in the **Test A** the number of points taken at each characterization is reduced to 5;
- in the **Test B**, the first characterization, usually realized at time 0 is supposed complete, in the following the number of points is reduced to 3.

In the D6.2, 3 characterizations are shown to be enough for an accurate prediction (3.9% of error on the final behavior prediction). This amount should not be changed as it is satisfying. The reduction of the number of points per measure (EIS or polarization curve) should not imply an increase of the size for the learning set. So in the following, only three characterizations are used for the process.

The process realized for each test is the following :

1. the updating procedure is realized on each characterization we consider;
2. the exponential models are identified;
3. the prediction of the behavior is realized.

The evaluation of the quality of the results is done on different points. First, the fitting of the characterizations is evaluated. Then is given the time necessary for measuring an EIS and finally the error on the end of the prediction is calculated on: the polarization curve and the behavior between 2000h and 2120h.

The comparison is done between the tests, but also with the results with the complete characterizations done in D6.2.

## 3 Test A: Reduction of the number of points for each characterization

### 3.1 Reduction of the number of points

The number of points taken for each measurement (EIS and polarization curve) is reduced to 5. The points are not specifically chosen as specific solicitation. As so if the EIS is composed

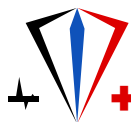

of 80 points initially, the 1<sup>st</sup>, the 20<sup>th</sup>, the 40<sup>th</sup>, the 60<sup>th</sup> and the 80<sup>th</sup> are the one used for the updating procedure.

The frequencies kept for the treatment of the EIS at the third characterization are reported in the table 1 in which the time necessary for each point measurement is precised. For the measurement of the EIS, a sollicitation under 10Hz will imply the realization of 5 cycles for the measurement of the point, and 10 for the higher frequencies.

Current of the EIS	Point frequency (Hz)	Time (s)
15A (Total 39s )	0.15	34
	1.16	4.3
	10	1
	86.6	0.11
	673	0.015
25A (Total 32s )	0.18	27
	1.29	3.9
	10	1
	69.8	0.14
	542	0.018
30A (Total 59s )	0.09	52
	0.75	6.67
	6.5	0.77
	56.2	0.18
	487	0.02

Table 1: Points used frequencies and respected time at 620h

The EIS measurement lasts less than one minute thanks to the reduction of points to 5; this measure can take more than 15 minutes usually.

### 3.2 Updating procedure

The updating procedure for the model is realized on the characterizations used for the learning phase, the first three usable (so the one at 620h, 800h, 984h).

The errors on the regressions for the EIS and polarization curves are reported on the tables 2 and 3. Even though only 5 points are used for the regression, the whole measurement is used for the calculation of the fitting's errors. They show a good adjustment measure / model with only 5 points used for the fitting.

	Mean error
RMSE	$1.97E^{-2}$
$R^2$	0.97

Table 2: Mean error on the fitting of the polarization curve





	Imaginary part	Real part
RMSE	$5.00E^{-3}$	$4.26E^{-3}$
$R^2$	0.981	0.9999

Table 3: Mean error on the real and imaginary parts of Nyquist plans' fitting

The use of the EIS lasting 32s doesn't trigger a higher error than the one lasting 59s.

### 3.3 Behavior prediction

Finally, the values obtained for the parameters are fitted to exponential functions. These functions are used for the prediction.

The error calculated between 2000h and 2120h is 0.055 for the RMSE and 6.67% for the MAPE. It shows that the prediction is honorable. The prediction of the last polarization curve is also accurate with an adjustment coefficient of 0.97 and a MAPE of 1.67% (Figure 4).

Polarization curve	MAPE (%)	$R^2$
6 (1130h)	2.4	0.96
7 (1298h)	1.79	0.97
8 (1465h)	1.79	0.98
9 (1635h)	1.68	0.98
10 (1800h)	1.49	0.98
11 (1968h)	1.58	0.97
12 (2010h)	1.67	0.97

Table 4: Errors between the polarization curves predicted and measured

The reduction of the points' amount at each characterization is viable. The measurements are then doable and quick.

## 4 Test B: reduction of the number of points after the first characterization

### 4.1 Reduction of the number of points

In order to lower even more the amount of data to obtain while the stack is in operation, we aim at balancing a new idea. Here, we consider that the first characterization can be complete, as it could be realized after the manufacture, so before its commissioning. For each characterization following, the polarization curve and EIS would be measured with only 3 points.

On the table 5, the times for the measurement of EIS is reported, as well as the frequencies used. The times necessary for theses reduced EIS are included between 28s and 53s a very reasonable time for an on-line measure on a stationary system.



EIS current	Frequency (Hz)	Time (s)
15A (34s)	0.15	34
	10	1
	673	0.015
25A (28s)	0.18	27
	10	1
	542	0.018
30A (53s)	0.09	52
	6.5	0.77
	487	0.02

Table 5: Example of the frequencies and time needed for measuring them (third characterization)

## 4.2 Updating procedure

The regressions on the characterizations at 800h and 984h are done thanks to only three points, but the errors' calculation are done with the complete spectra.

In the tables 6 and 7 are reported the errors for the three characterizations used for the EIS and polarization curve fitting (i.e. regressions). As it can be seen, the errors are still low and satisfying.

	Mean error
RMSE	$1.36E^{-2}$
$R^2$	0.986

Table 6: Mean of the obtained errors on the three polarization curves used

	Imaginary part	Real part
RMSE	$5.00E^{-3}$	$4.26E^{-3}$
$R^2$	0.981	0.999

Table 7: Mean of the errors on the imaginary and real parts of the regressions on the Nyquist plot used

## 4.3 Behavior prediction

The simulation of the global model allows an error calculation with the measure. As before, it is done between 2000h and 2120h. The RMSE is 0.038 and the MAPE 4.33% , low errors that demonstrate the accuracy of the **Test B**.

The prediction of the last polarization confirms the legitimacy of this hypothesis with 1.57% for the MAPE and .098 for the  $R^2$  (Figure 8).



Polarization curve	MAPE (%)	$R^2$
6 (1130h)	1.27	0.98
7 (1298h)	0.88	0.98
8 (1465h)	0.84	0.987
9 (1635h)	0.89	0.987
10 (1800h)	1.01	0.988
11 (1968h)	1.28	0.98
12 (2010h)	1.57	0.98

Table 8: Error between the predicted and measured polarization curve

## 5 Synthesis

The realization on-line of the prediction approached proposed seems to be jeopardized by the amount of data necessary. Indeed, the measurement of EIS, for a better prediction, is not possible yet on the system.

However, this type of measurement is totally possible with low cost thanks to an other European project, D-CODE [2]. The possibility of the quick realization of characterizations is shown thanks to two tests.

The table 9 reports the results for the prediction errors with the standard simulation (on D6.2) and with both tests.

The errors are slightly higher with the reduction of data. The "worst" result is the **Test A**. The idea of a first complete characterization allows taking only 3 points for the following characterizations with a better result. As a conclusion, the prognostics approach can be deployed with reduced characterizations phases while maintaining quite accurate performances (as reported in the table below).

	Pola's prediction à 2016h	Final behavior prediction
Initial (D6.2)	1.26%	3.9%
<b>Test A</b> : 5 points used (3)	1.67%	6.67%
<b>Test B</b> : complete then 3 points (4)	1.57%	4.33%

Table 9: Comparison of the MAPE on the predictions

The **Test B** is the best compromise. With the realization of an EIS in less than a minute, the approach offers a good prediction.



## References

- [1] Elodie Lechartier, Elie Laffly, Marie-Cécile Péra, Rafael Gouriveau, Daniel Hissel, and Noureddine Zerhouni. Proton exchange membrane fuel cell behavioral model suitable for prognostics. *International Journal of Hydrogen Energy*, 40(26):8384 – 8397, 2015.
- [2] D-code - dcdc converter-based diagnostics for pem systems; <https://dcode.eifer.kit.edu/>.