

# Ionosphere: Past, Present and Future Problems

R.W. Schunk

Center for Atmospheric & Space Sciences  
Utah State University  
Logan, Utah 84321

CEDAR Meeting  
June 23, 2006

# Outline

- Ionospheric Environment
- Status
- High Latitudes
- Middle Latitudes
- Low Latitudes
- Summary

# Ionospheric Environment

# ATMOSPHERE

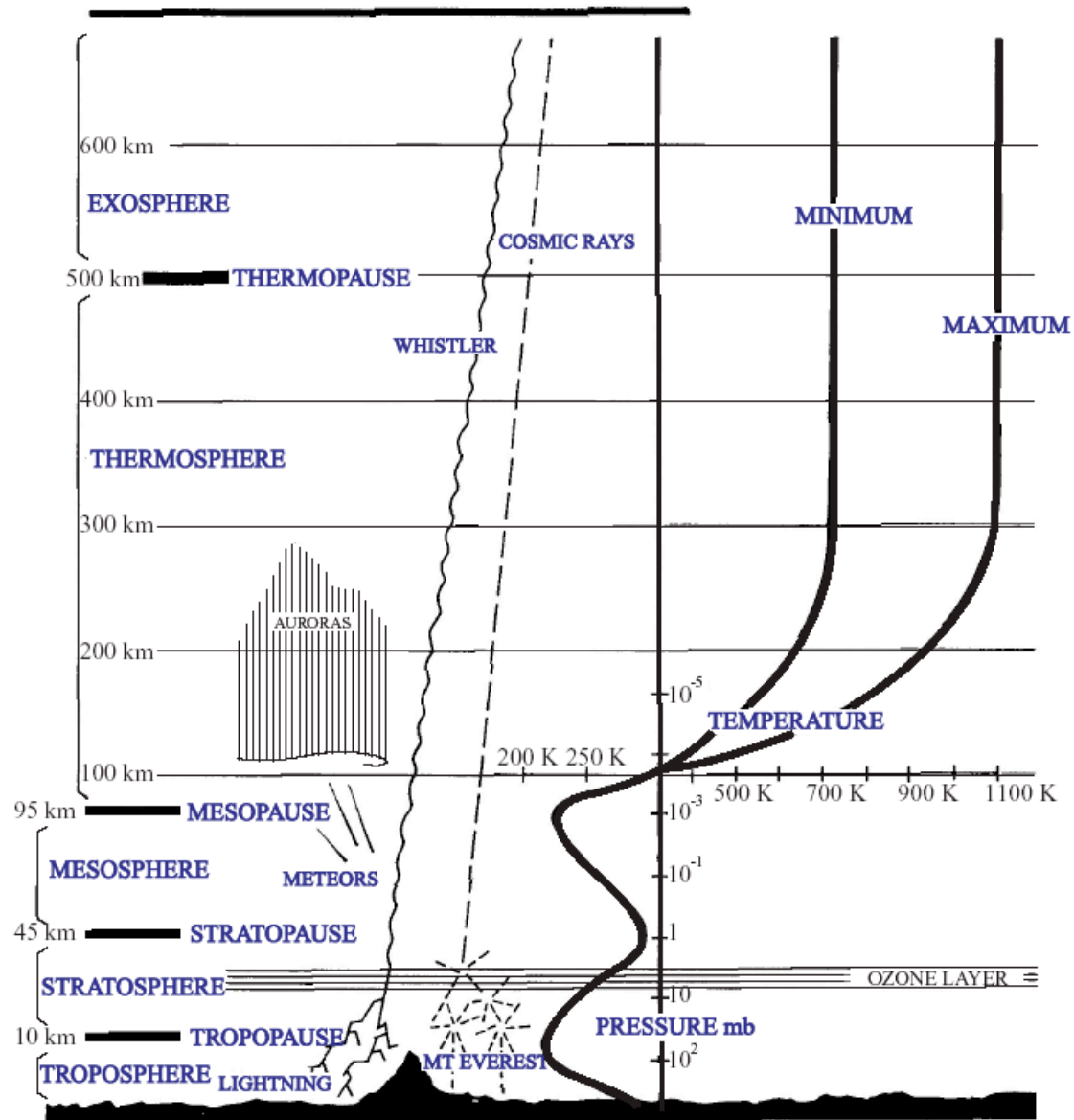

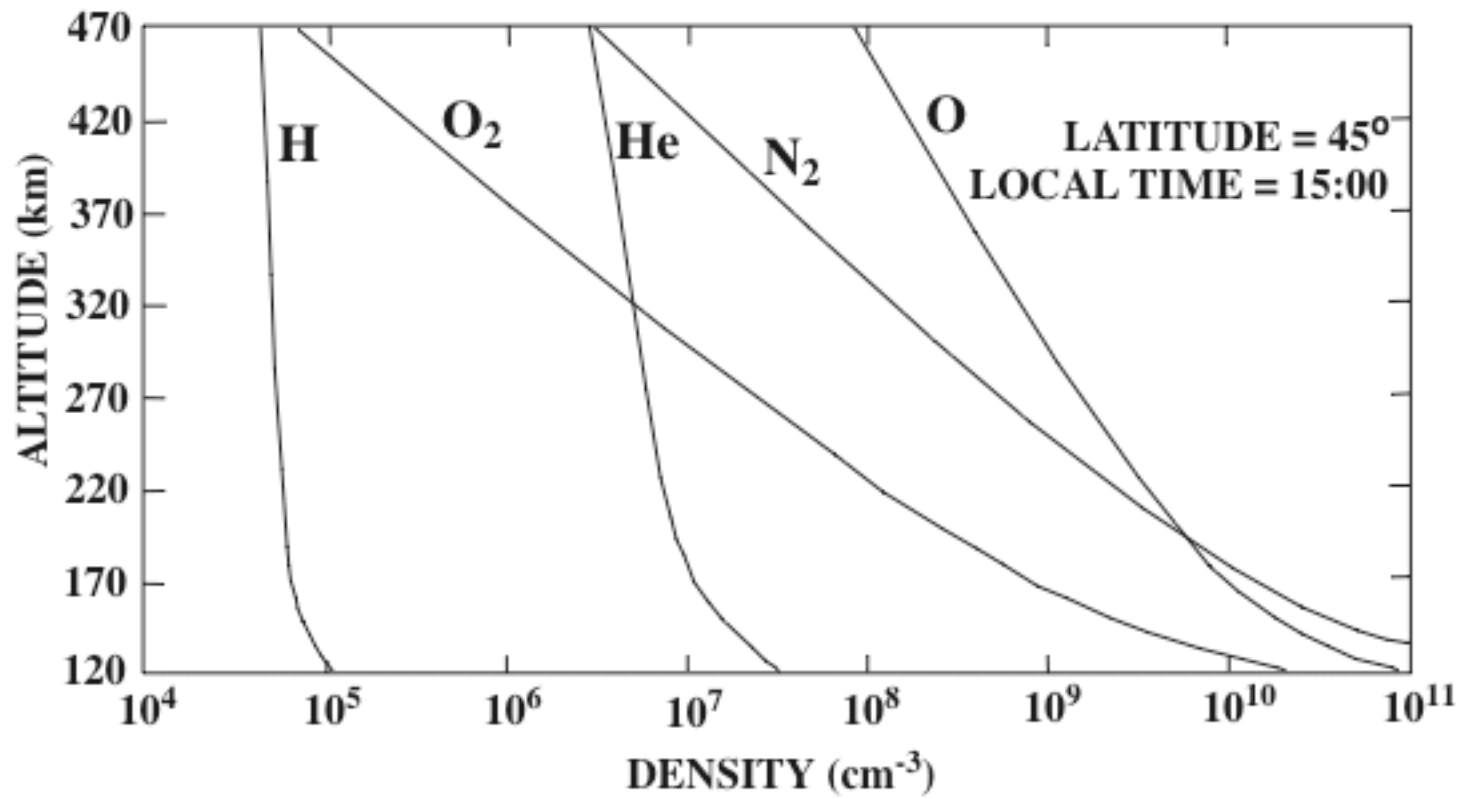

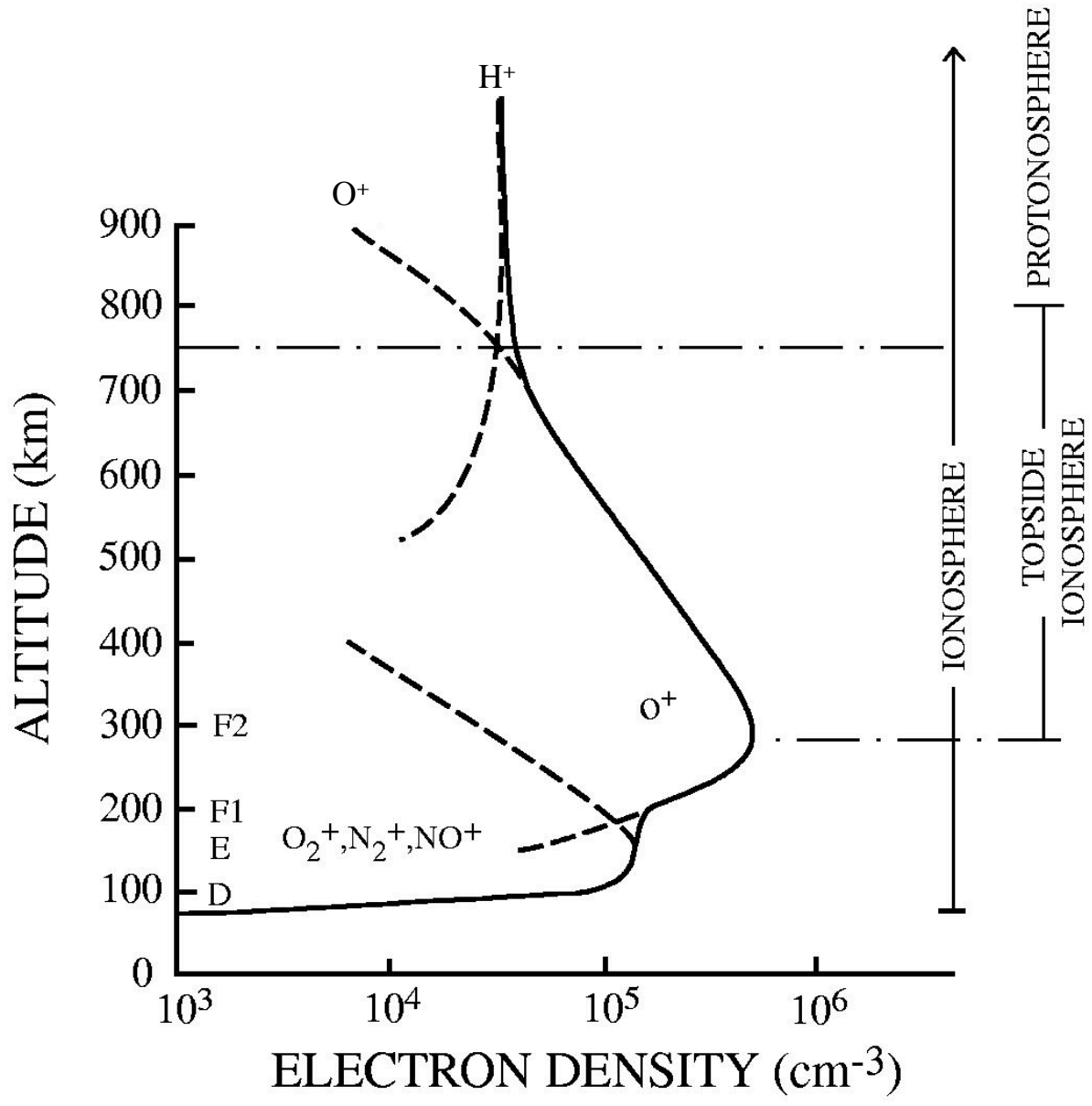

F-Region

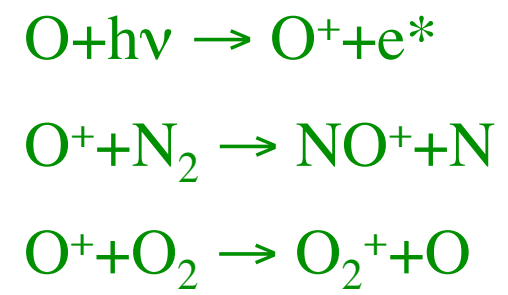

Topside



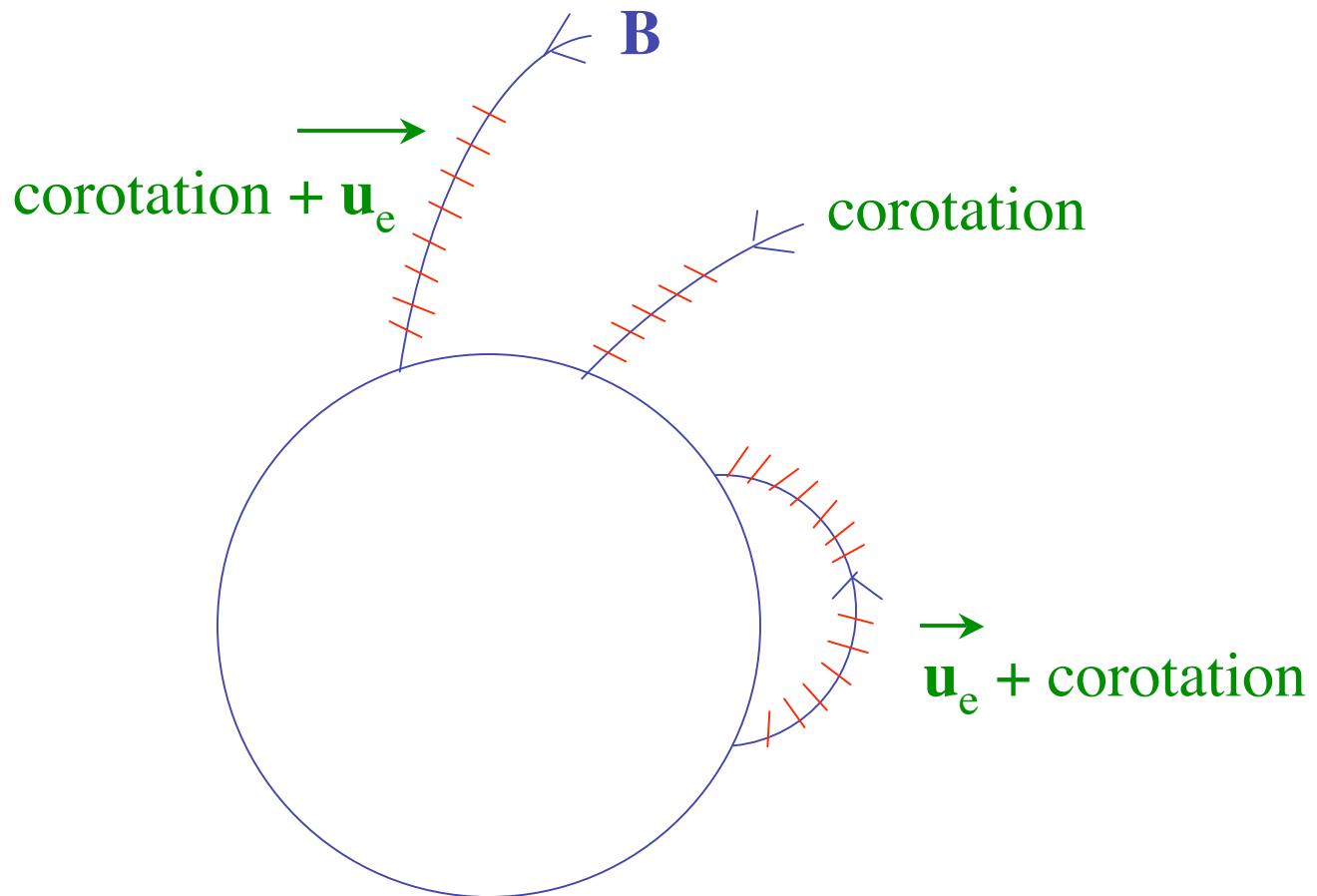

**Diffusion and Wind-Induced Flow Along B**

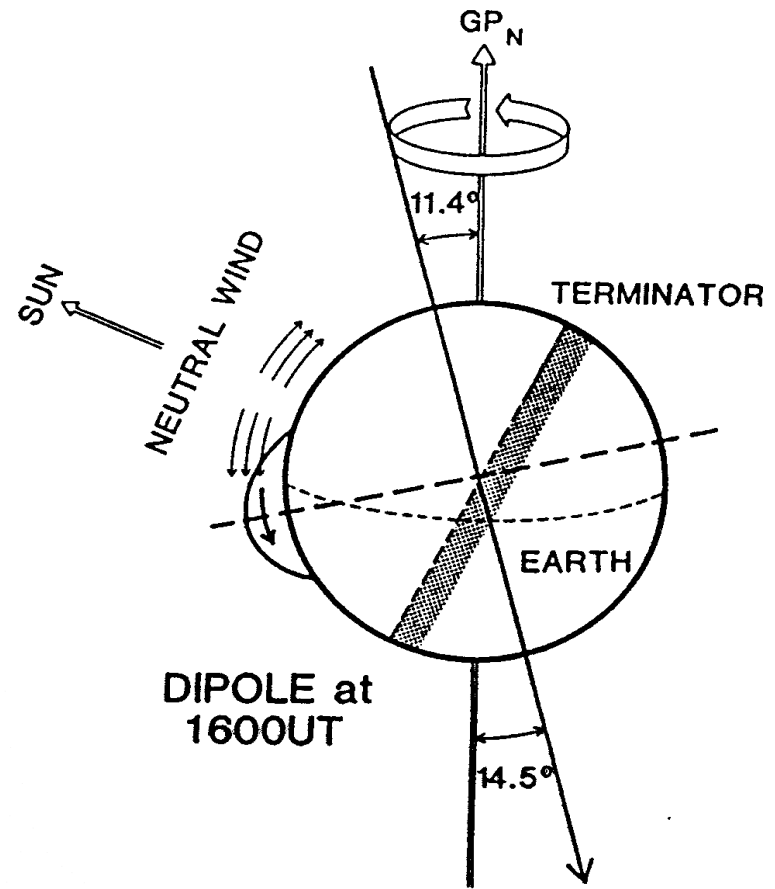
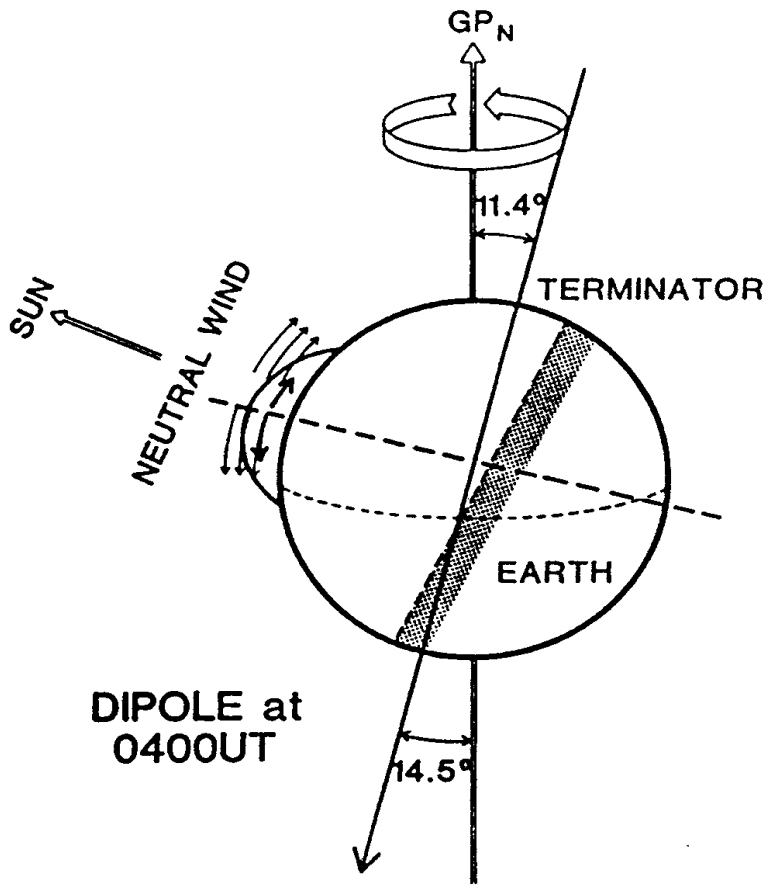

Sojka and Schunk (1979)



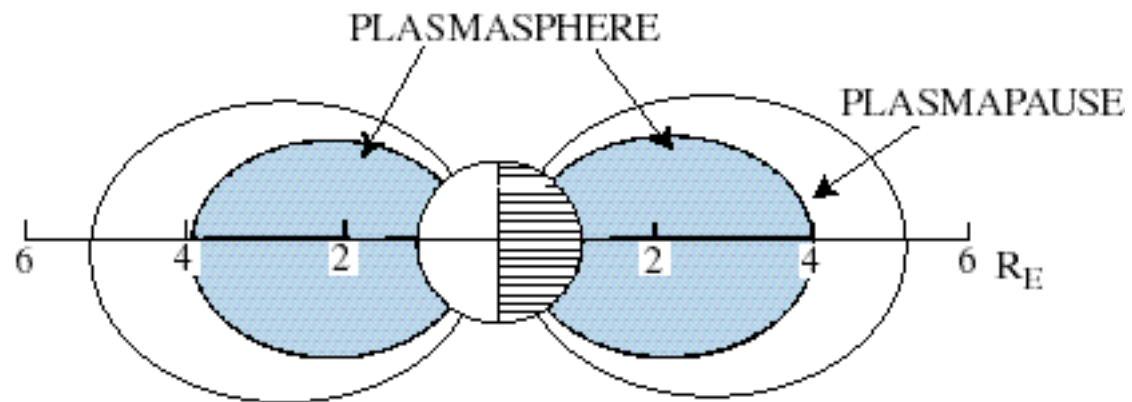
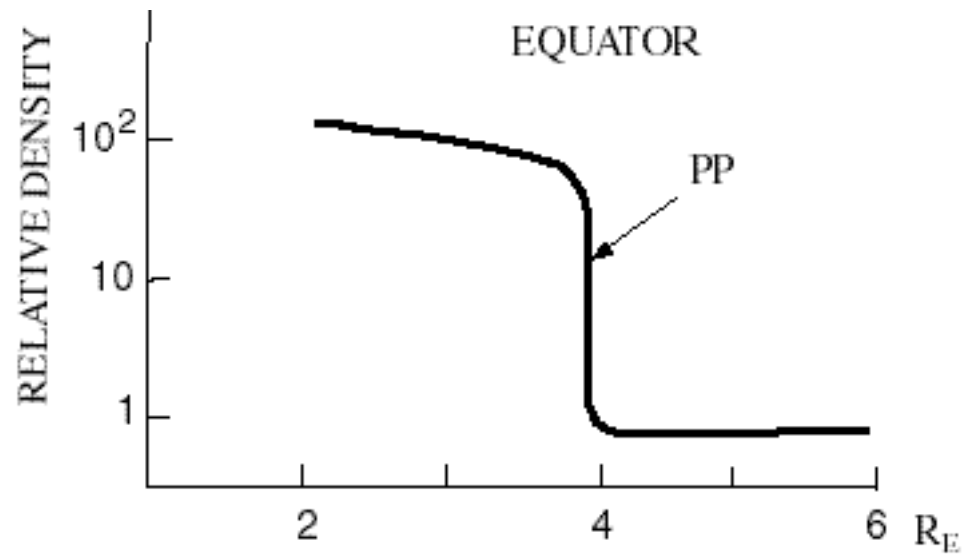

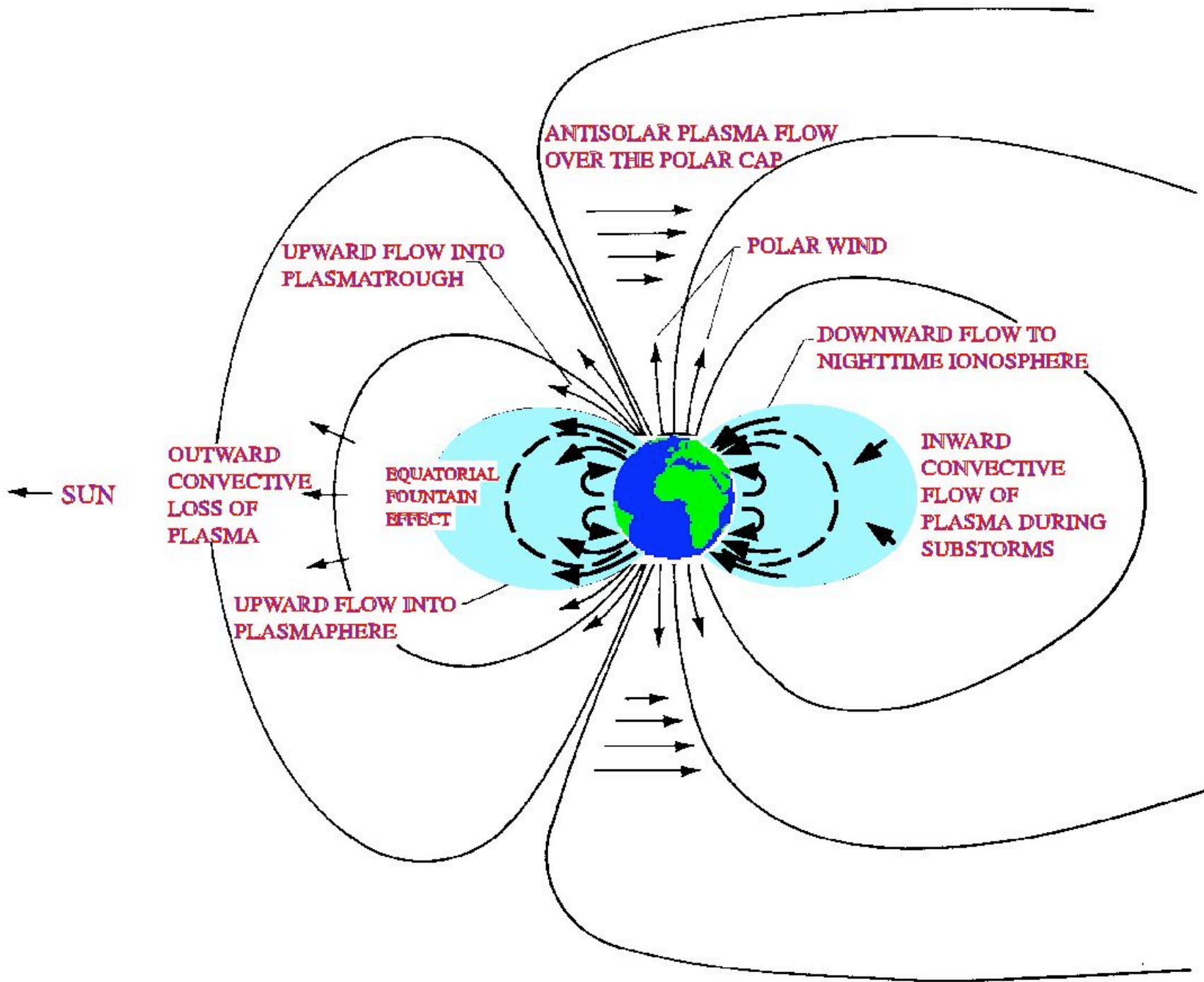

# Ionospheric Variations

- Altitude
- Latitude
- Longitude
- Universal Time
- Season
- Solar Cycle
- Geomagnetic Activity

## Status

- Ionosphere has both a Background State (Climatology) and a Disturbed State (Weather)
- Climatology is Basically Understood
- Weather Involves Storms, Substorms, Plasma Structures, Wave Activity, and Plasma Instabilities
- Main Research Focus is on Weather

# High Latitudes

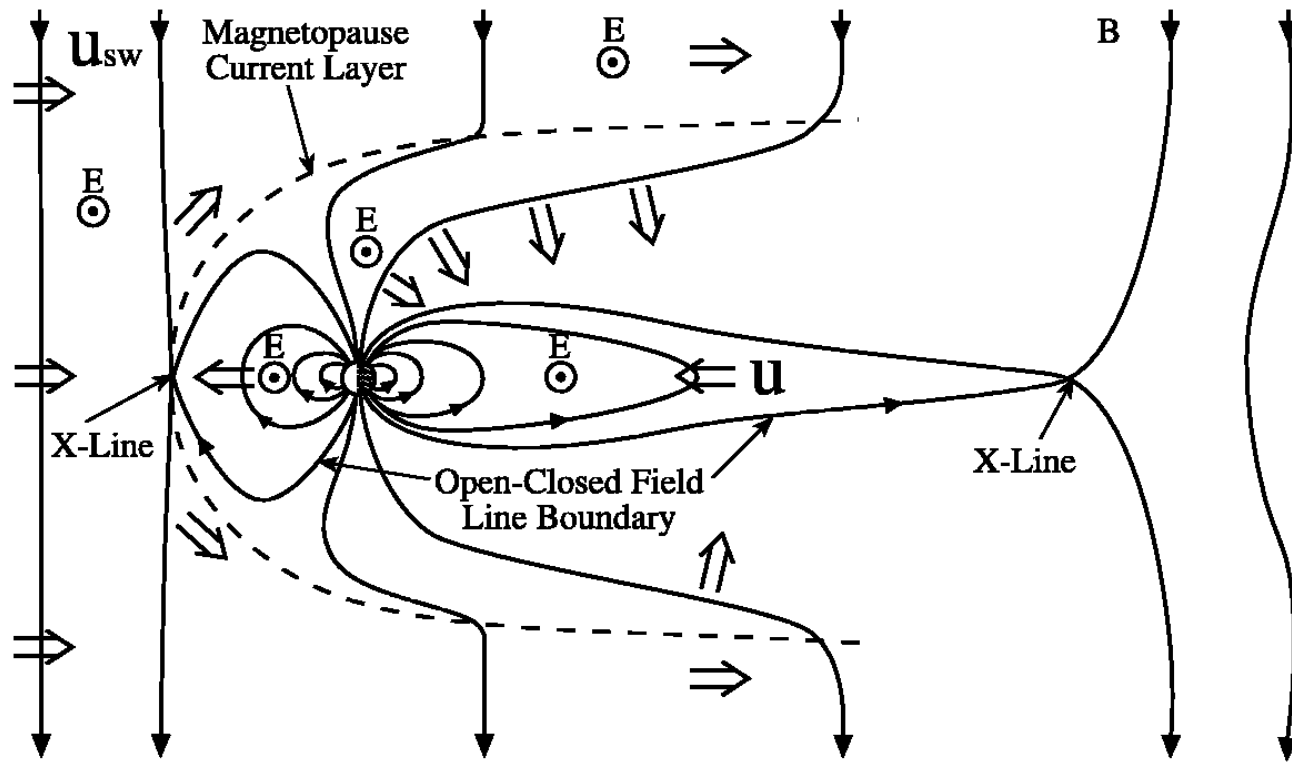

Lyons (1992)

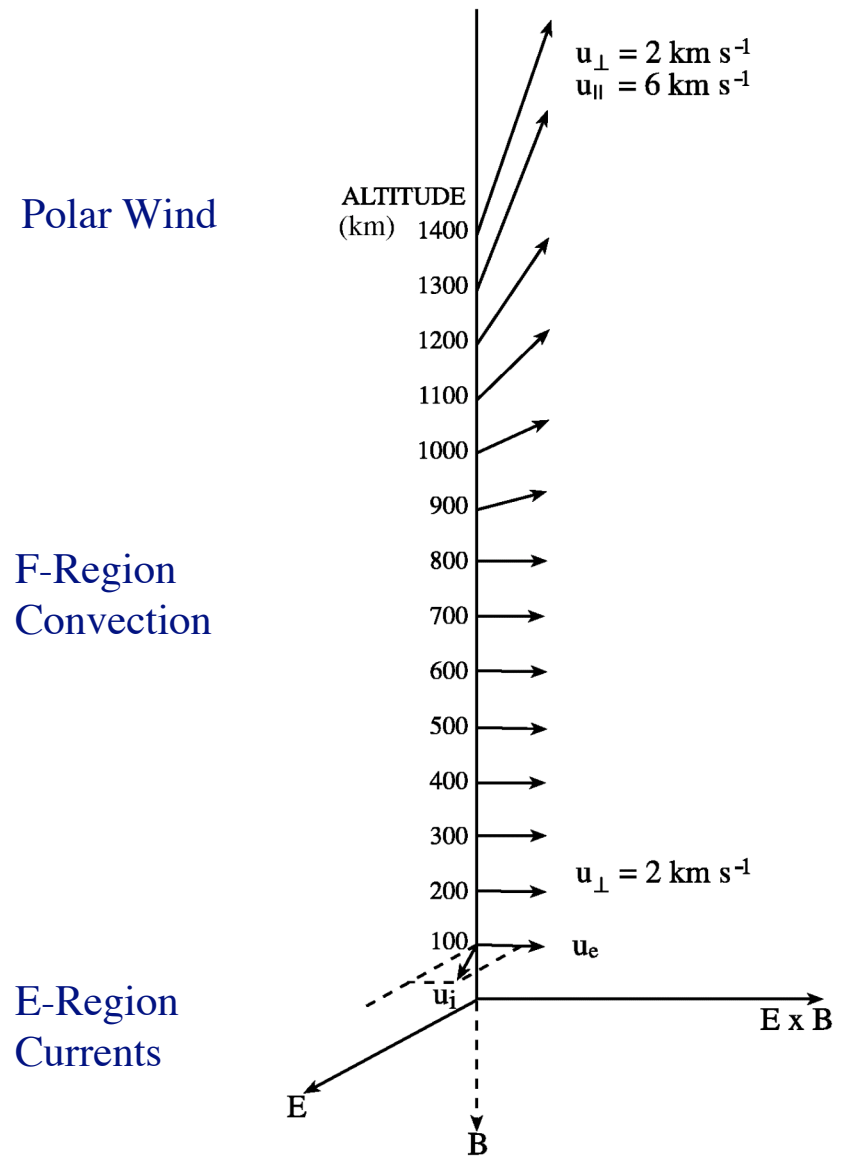

Schunk (1983)

# Volland Model

2-cell Pattern,  $\Delta\Phi=40$  kV, No Corotation

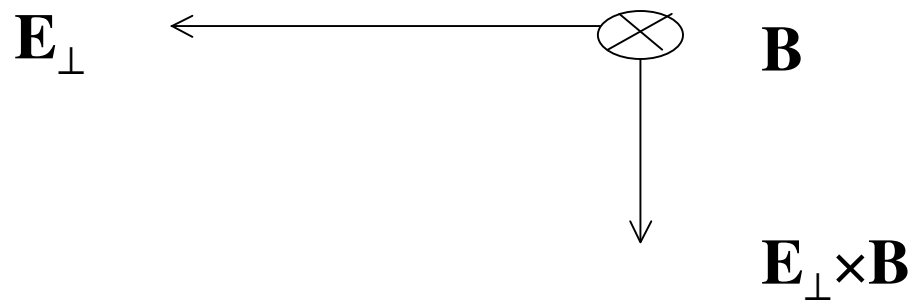
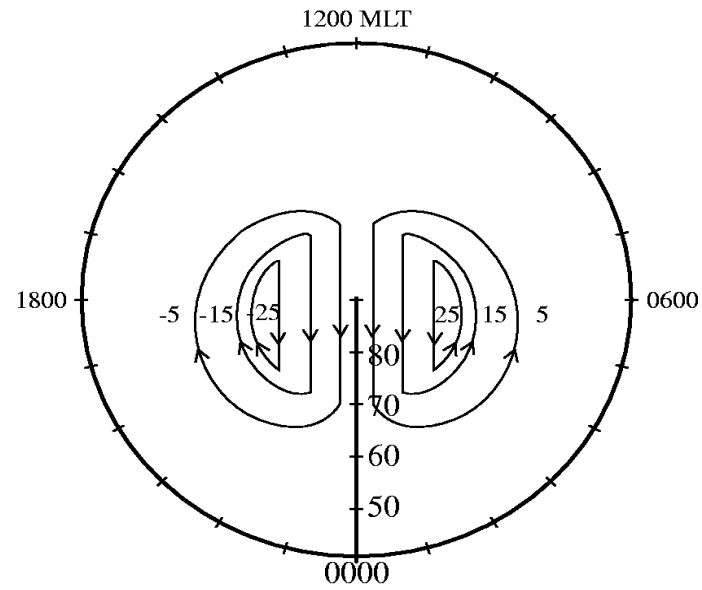



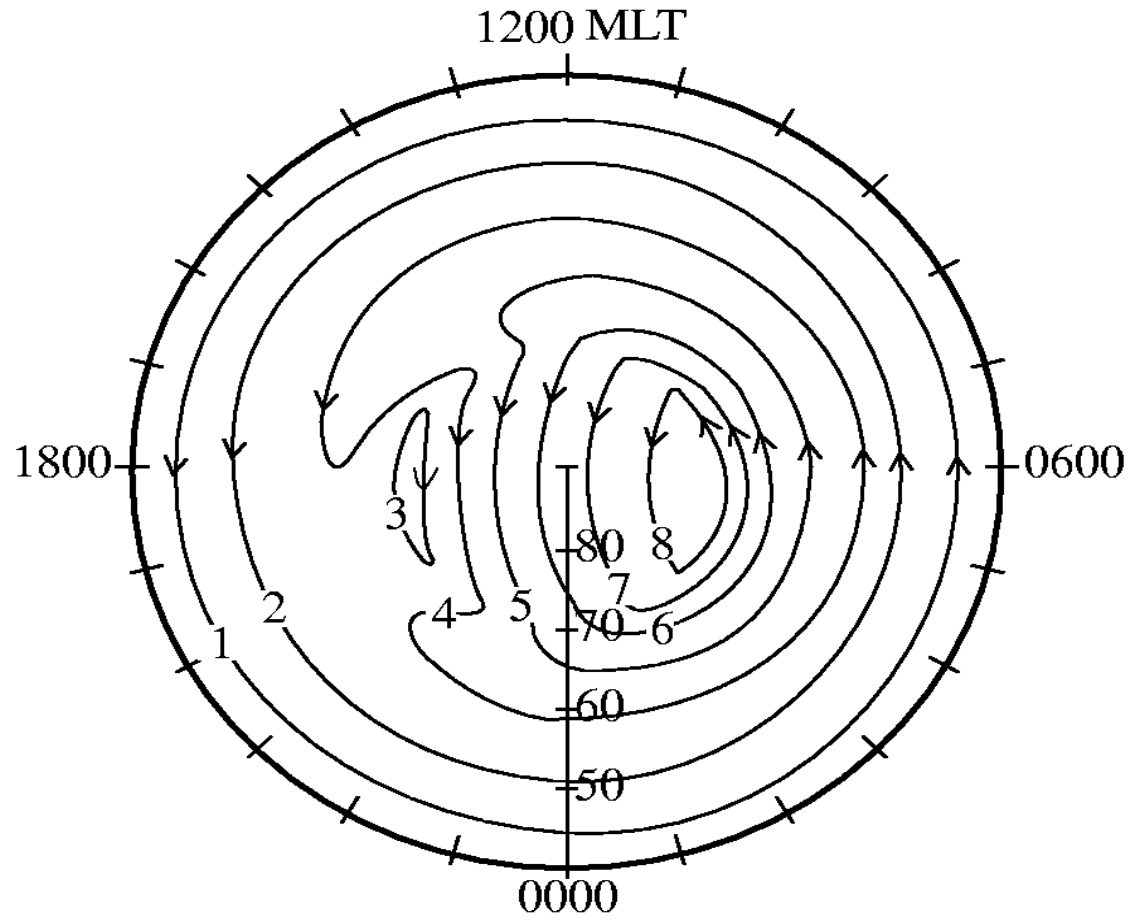

LABEL	1	2	3	4	5	6	7	8
CIRCULATION PERIOD (day)	1.00	1.01	0.10	1.34	0.50	0.31	0.18	0.11

Sojka et al. (1979)

# Geographic Inertial Frame

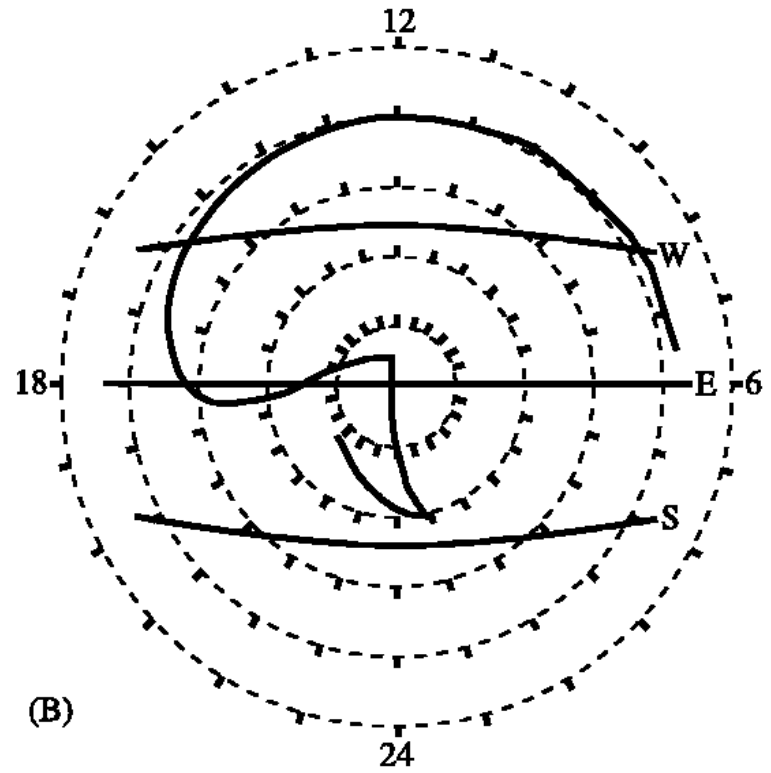
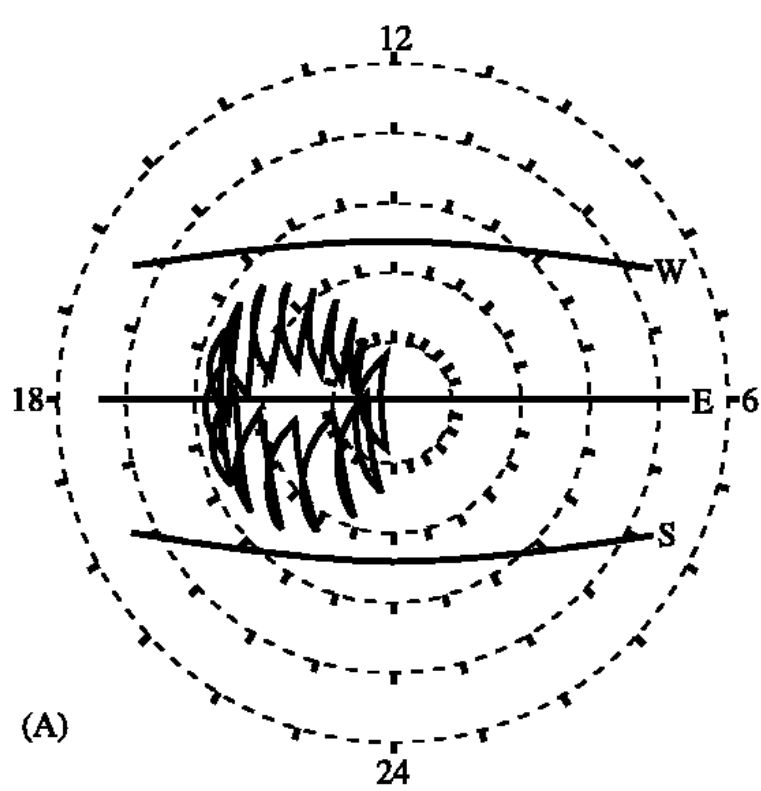

Sojka et al. (1979)

# High Latitude Climatology

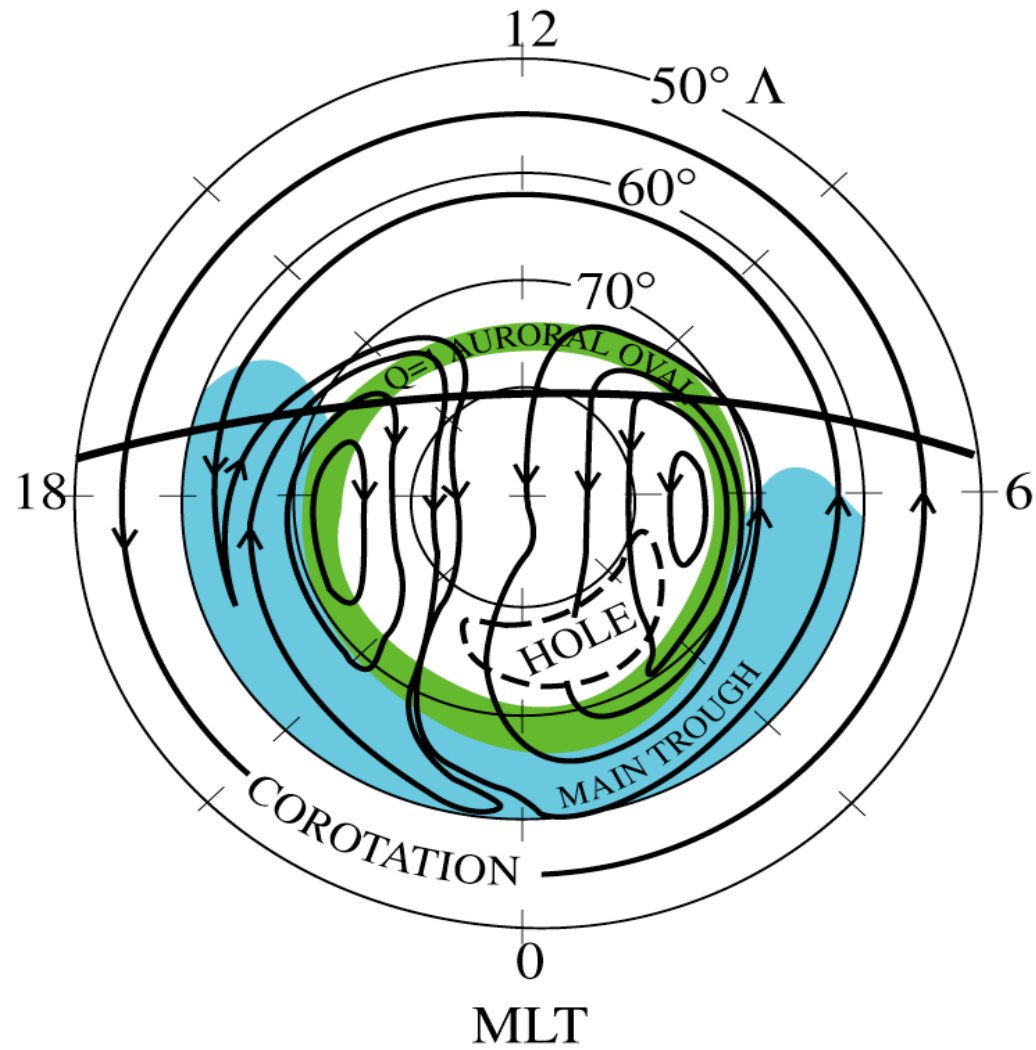

Brinton et al., 1978

# Storms and Substorms

- Ionosphere
  - Increased Convection Speeds
  - Increased Joule and Particle Heating
  - $O^+ \rightarrow NO^+$
  - $T_i \rightarrow T_{i||}, T_{i\perp}$
- Thermosphere
  - Gravity Waves
  - O/N<sub>2</sub> Changes
  - Enhanced Winds
  - Supersonic Winds
  - Anisotropic T<sub>n</sub>

# Satellite Images



- Ground Photograph by Jan Curtis.
- FUV Image from the IMAGE Satellite.

# Satellite Images

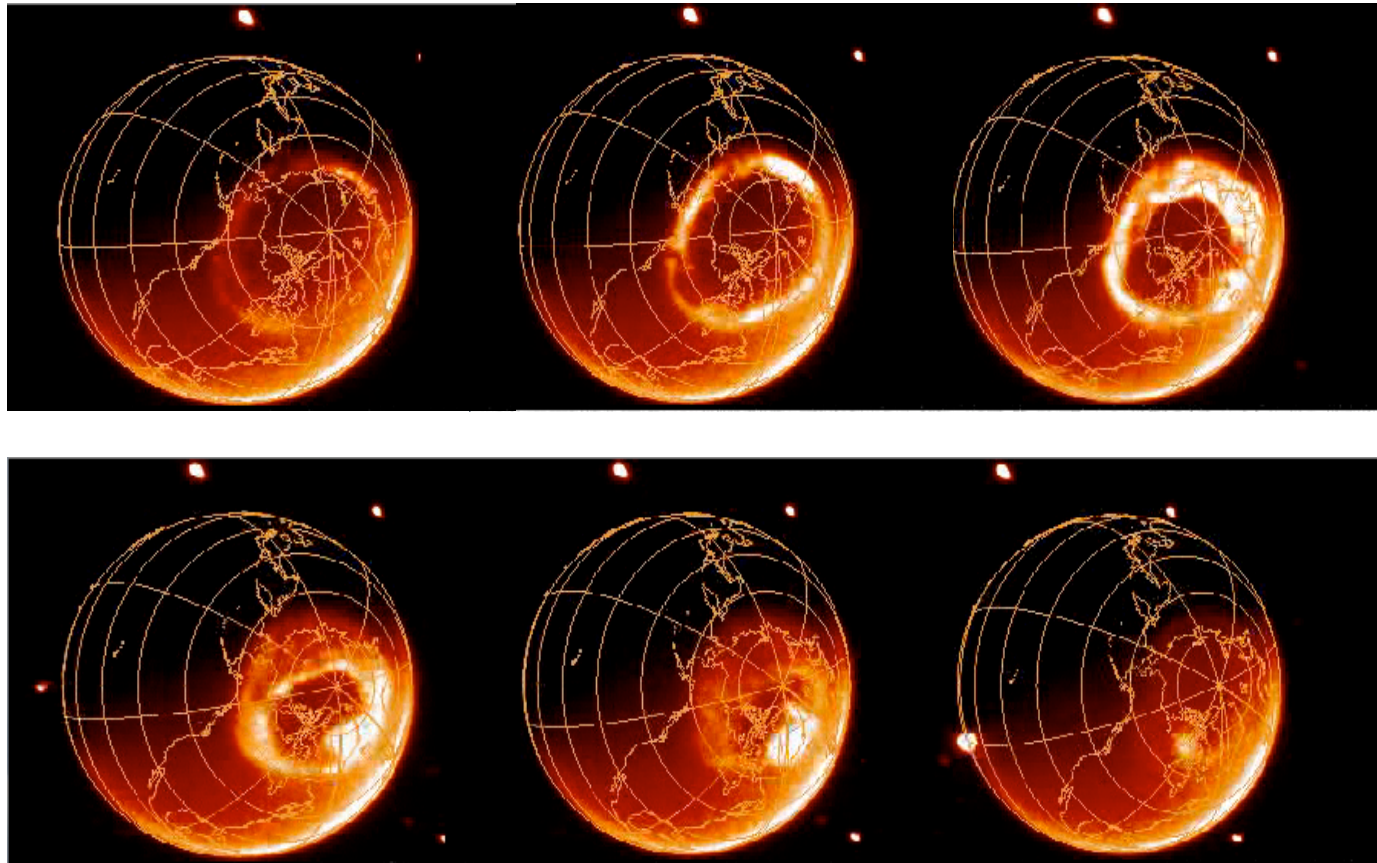

Burch, J. L., *Scientific American*, 284, 72-80, 2001

- Bastille Day Storm
- July 14-15, 2000
- Snapshots During a 1-Hour Period

# Ionosphere Forecast Model

## NmF2 UT 0700

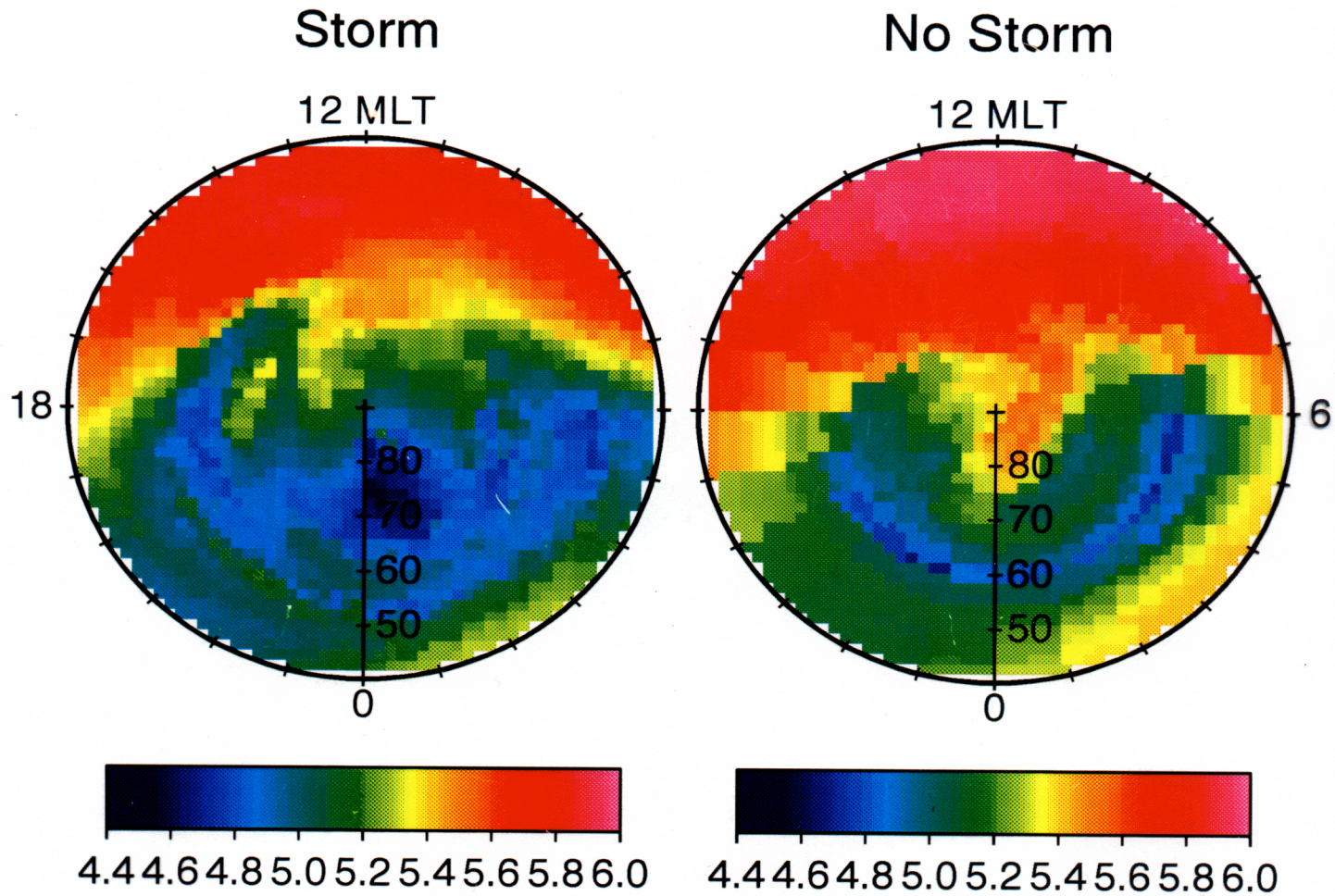

# Ionosphere Forecast Model

## O<sup>+</sup>/Ne 300 km UT 0700

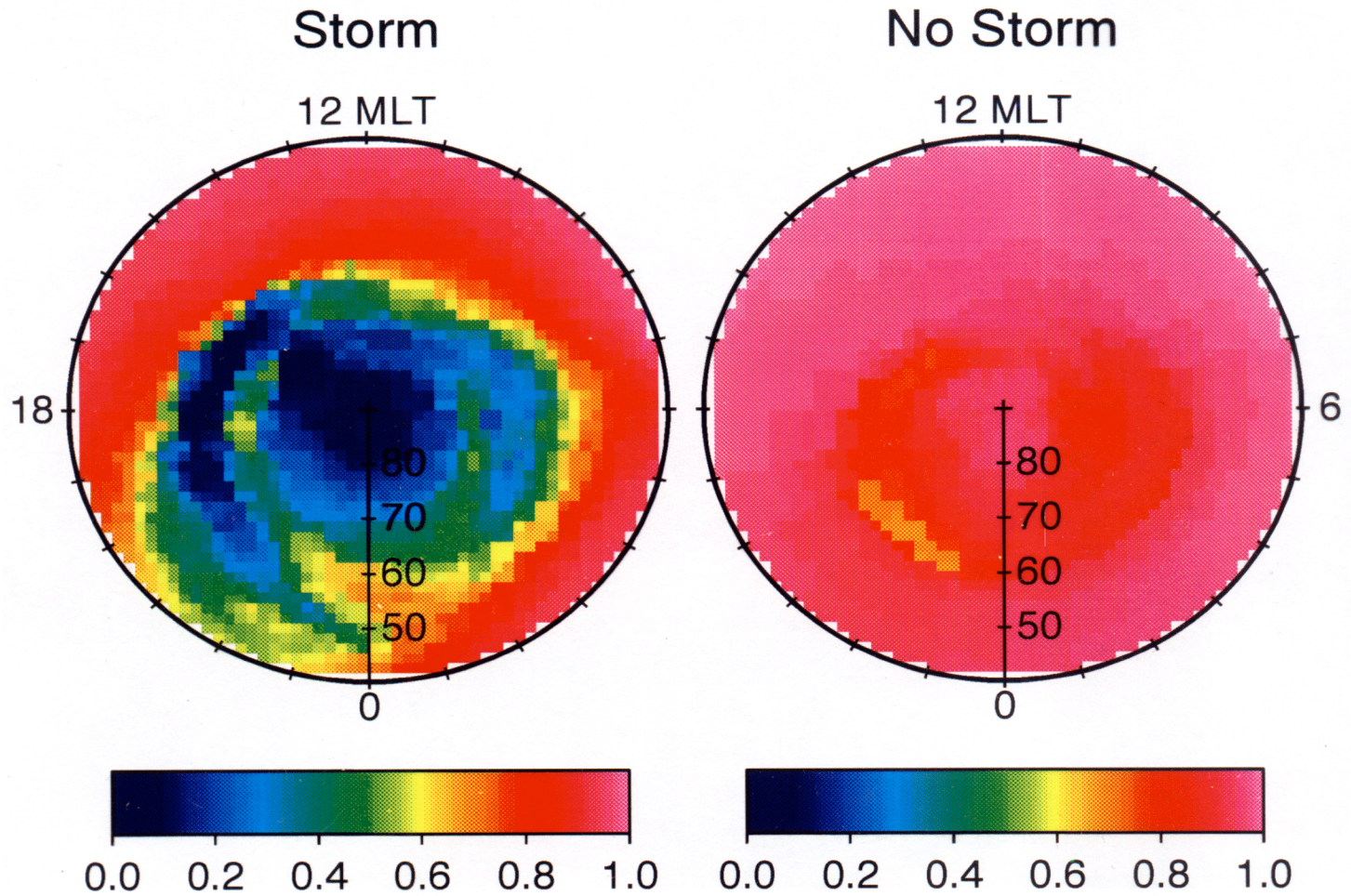



# Neutral Gas Expansion

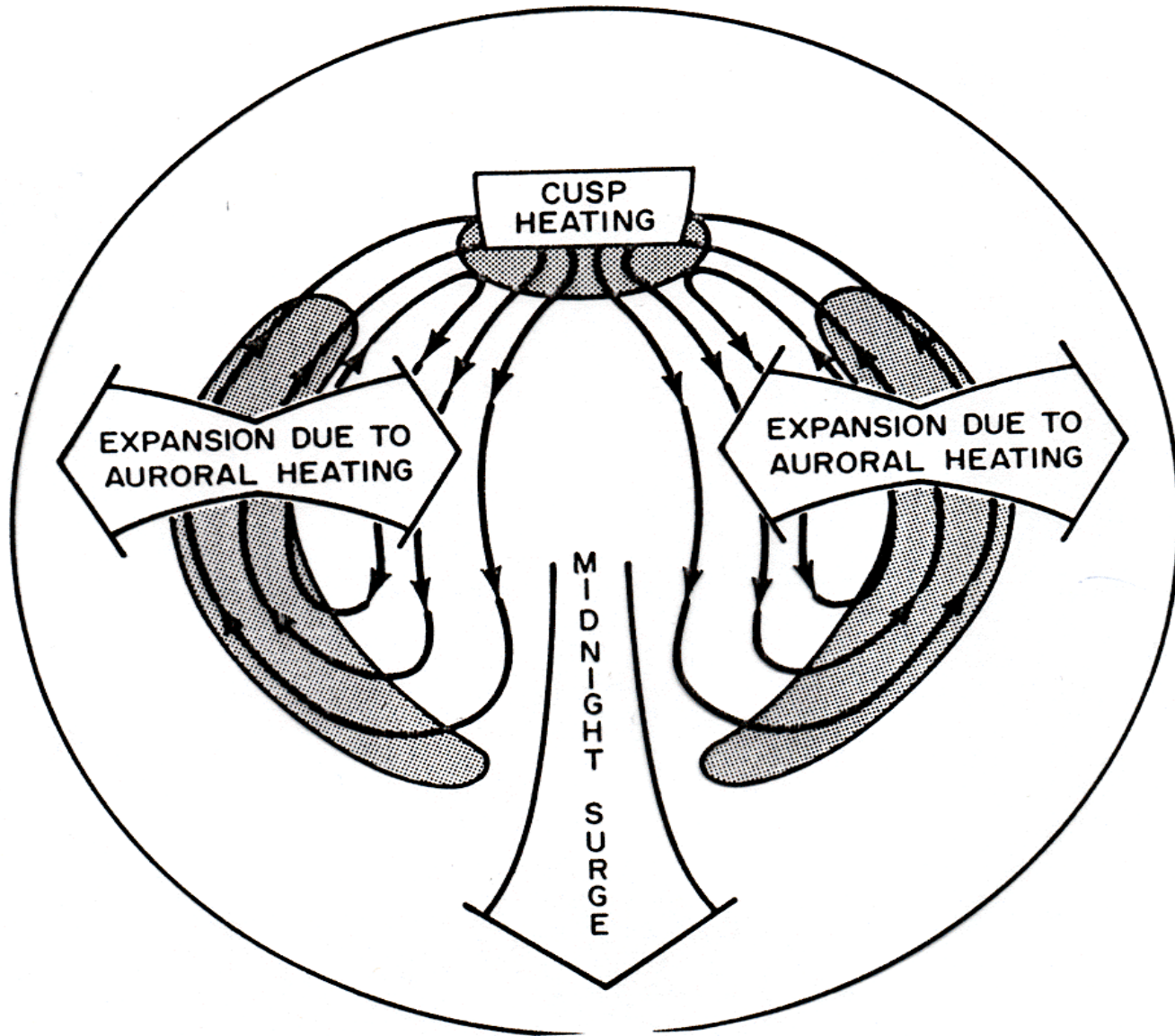

# Ion Polar Wind

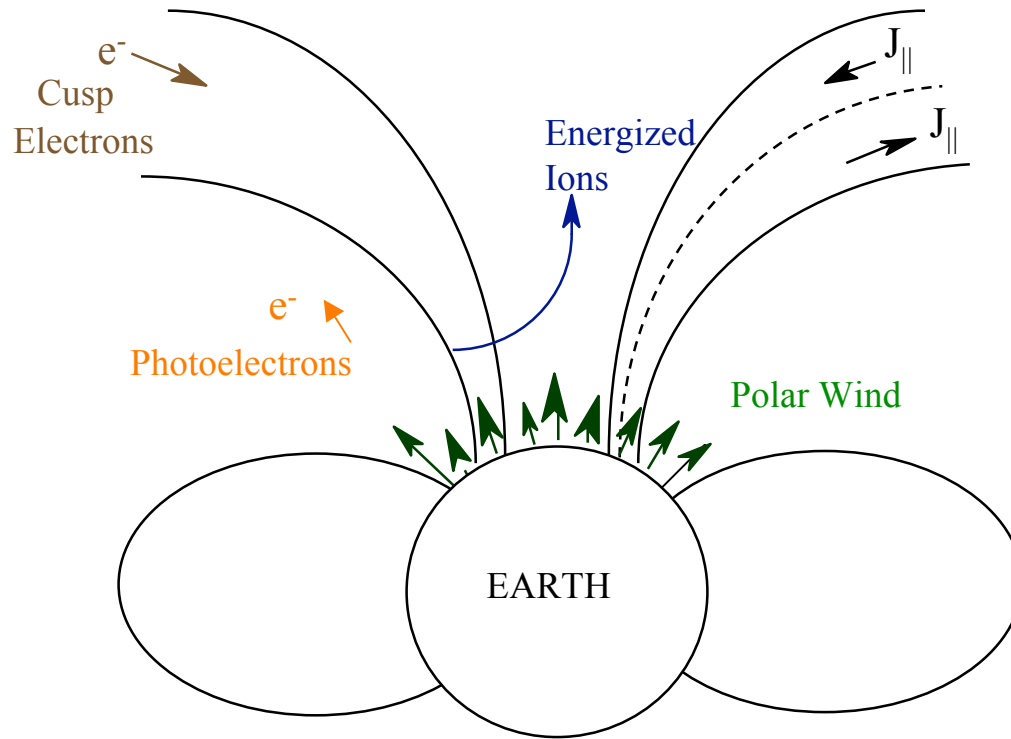

O<sup>+</sup> 6 UT

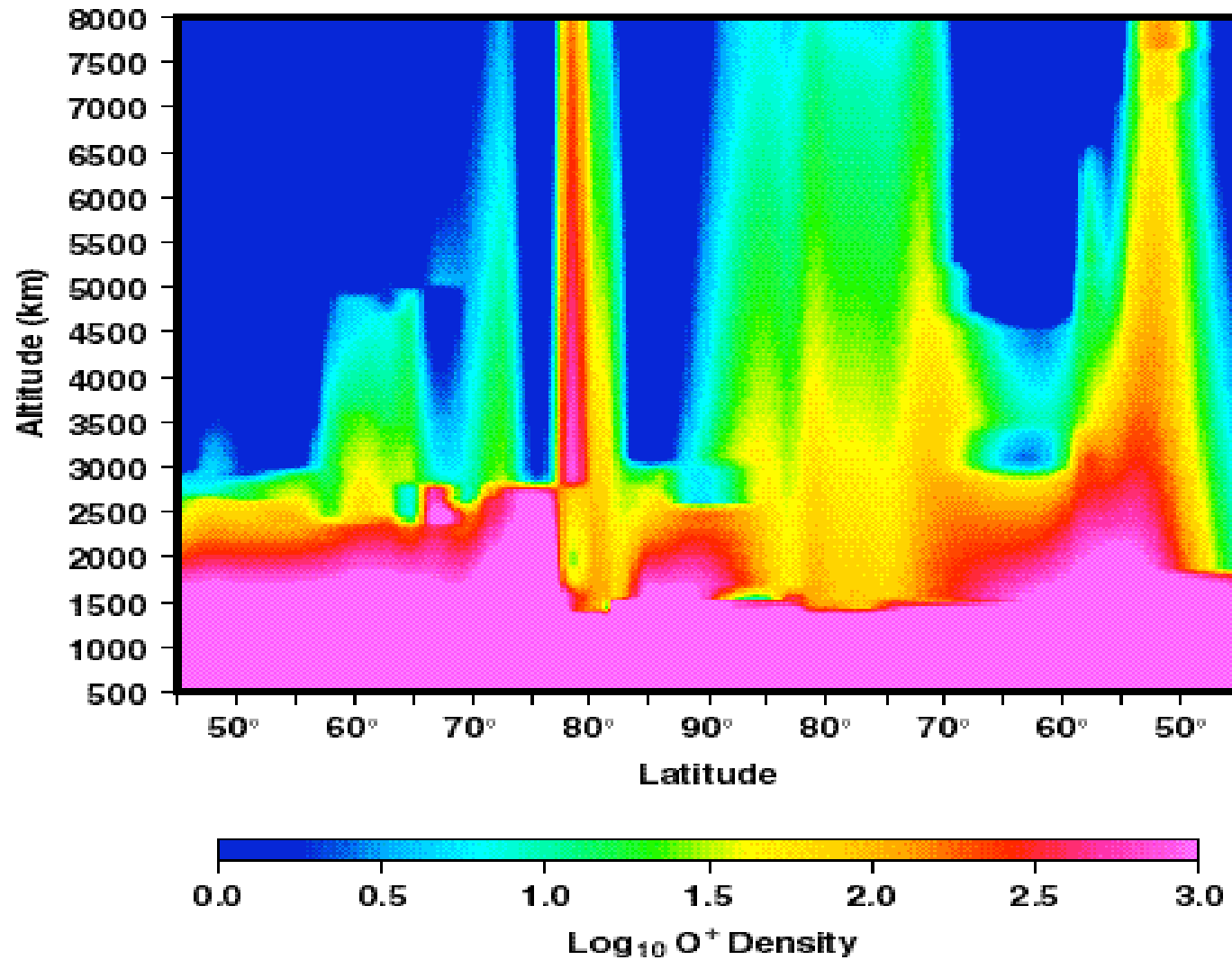

Demars and Schunk (2003)

H<sup>+</sup> 6 UT

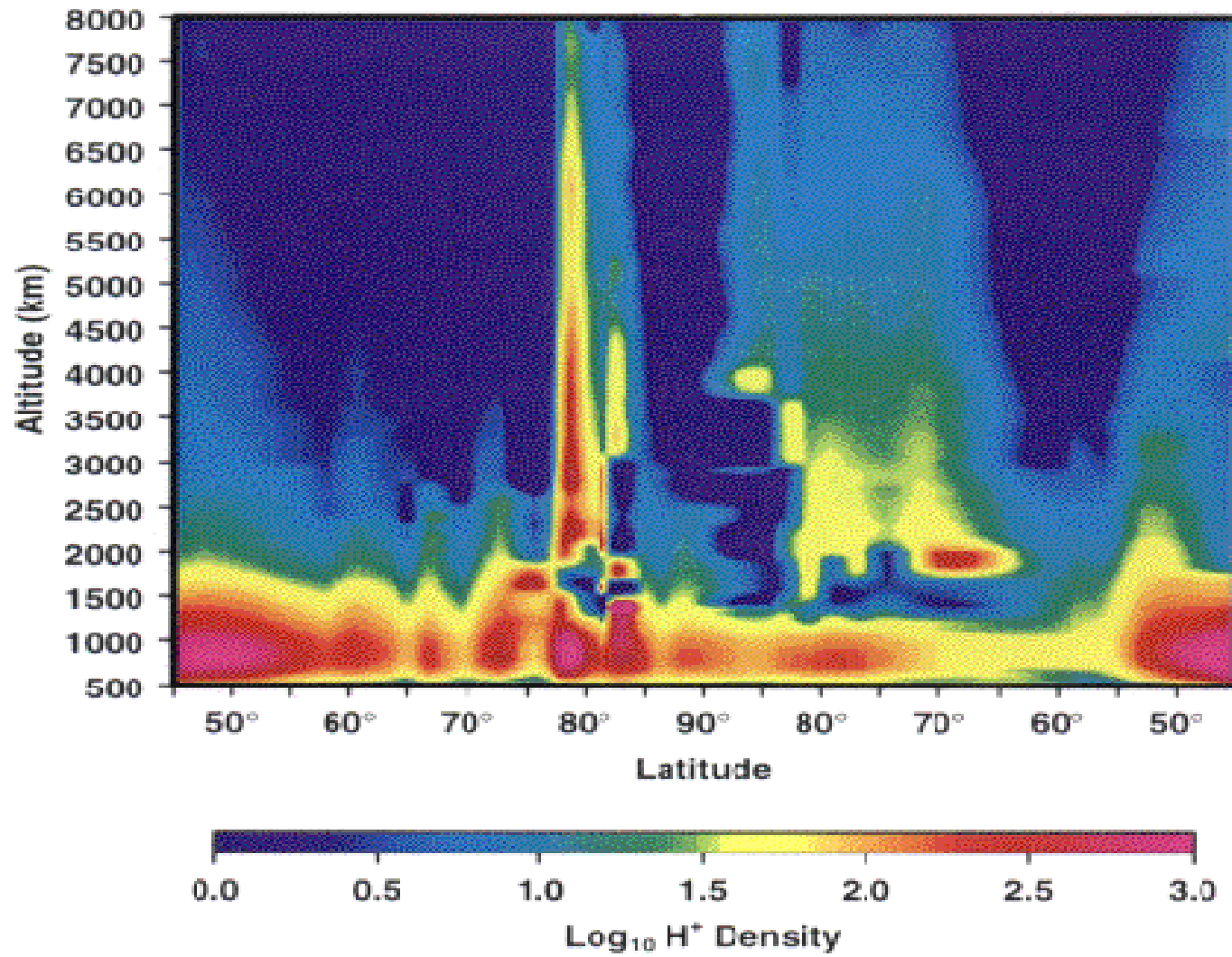

Demars and Schunk (2003)

# Neutral Polar Wind

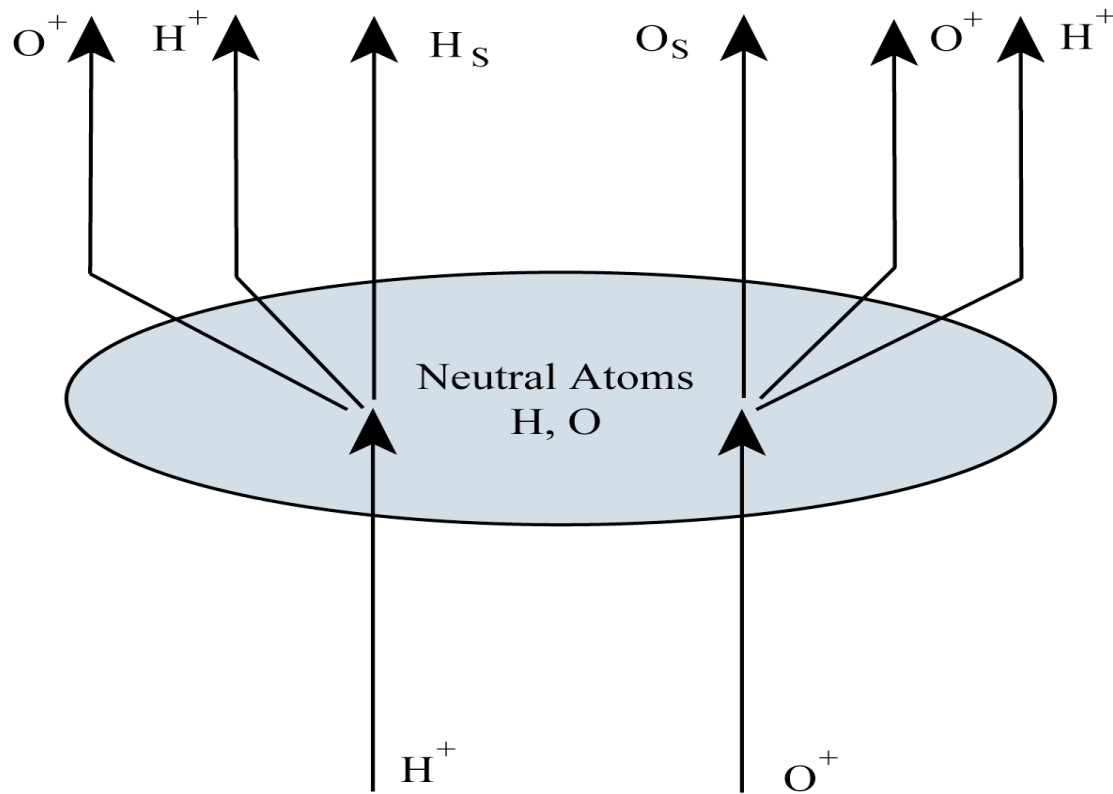

Gardner and Schunk (2004)

# Neutral Polar Wind

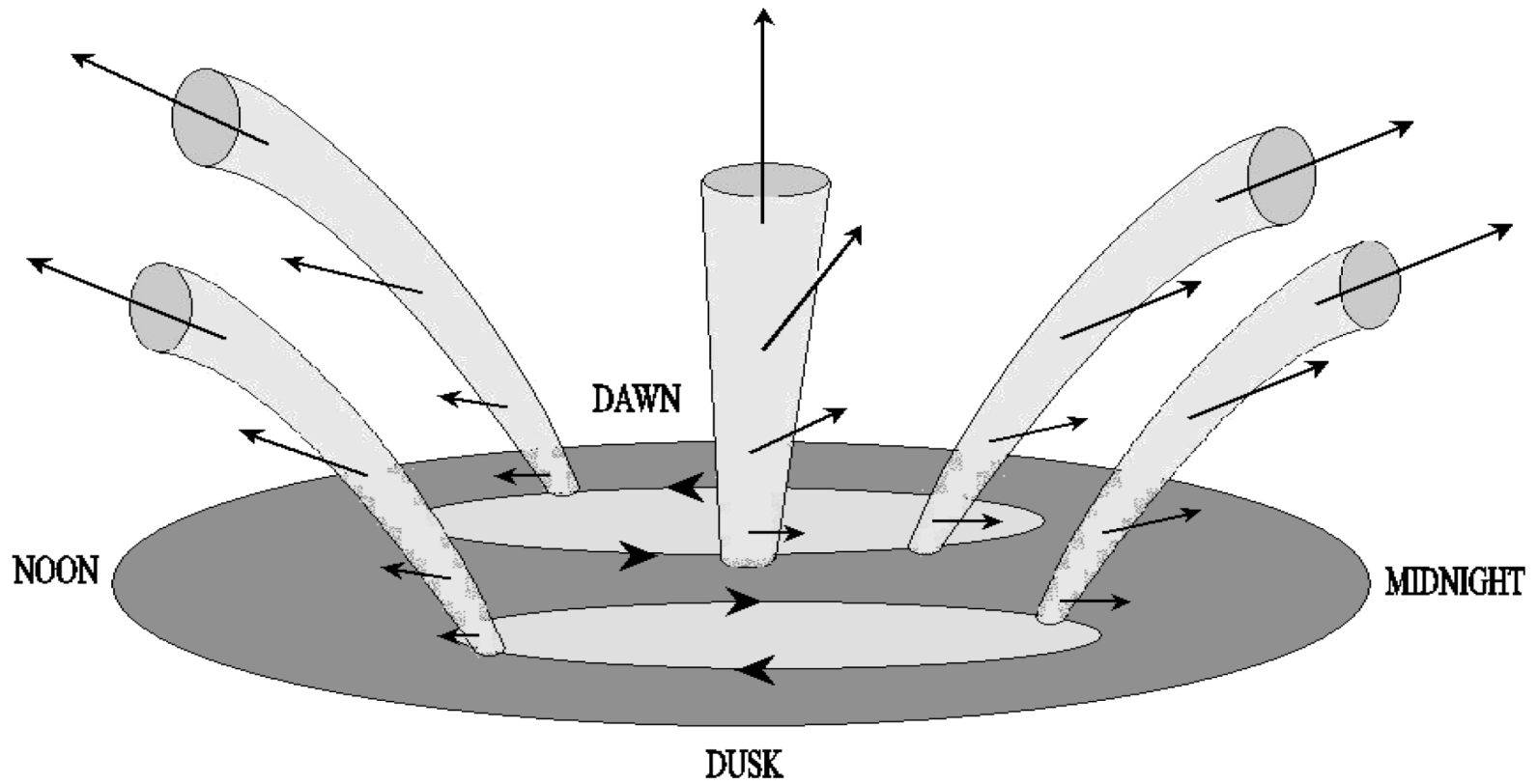

Gardner and Schunk (2004)

# Noon-Midnight Meridian Flux 6:10 UT

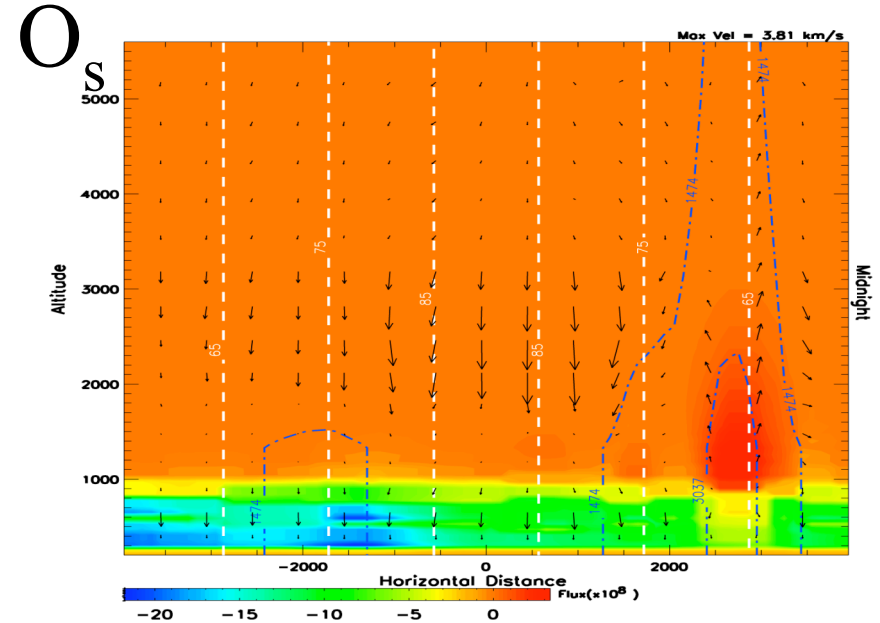
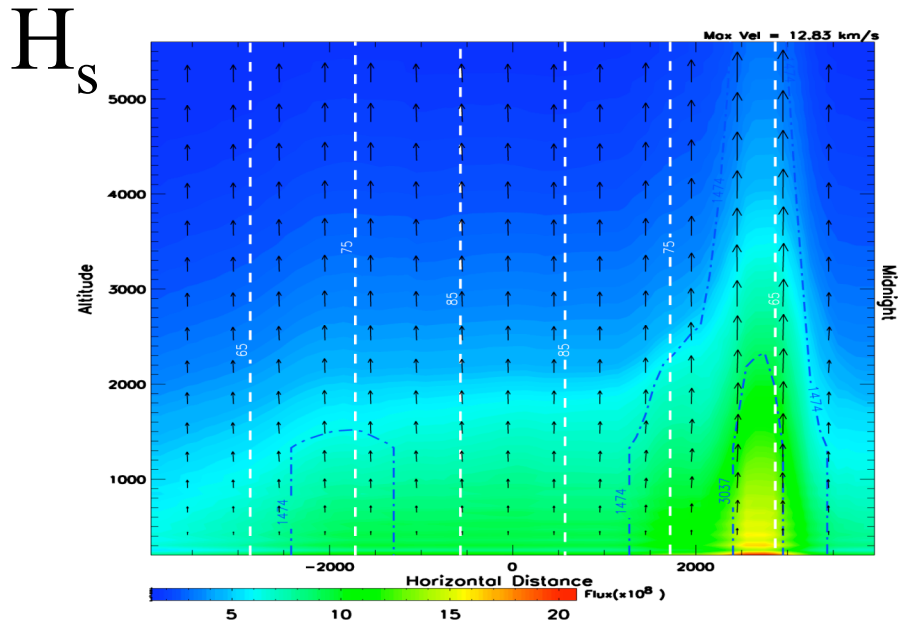
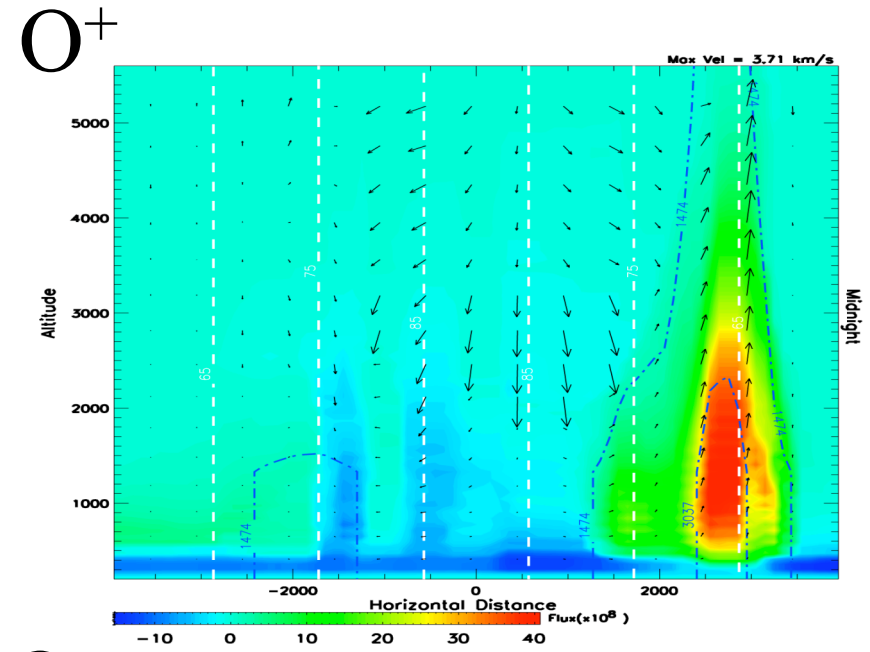
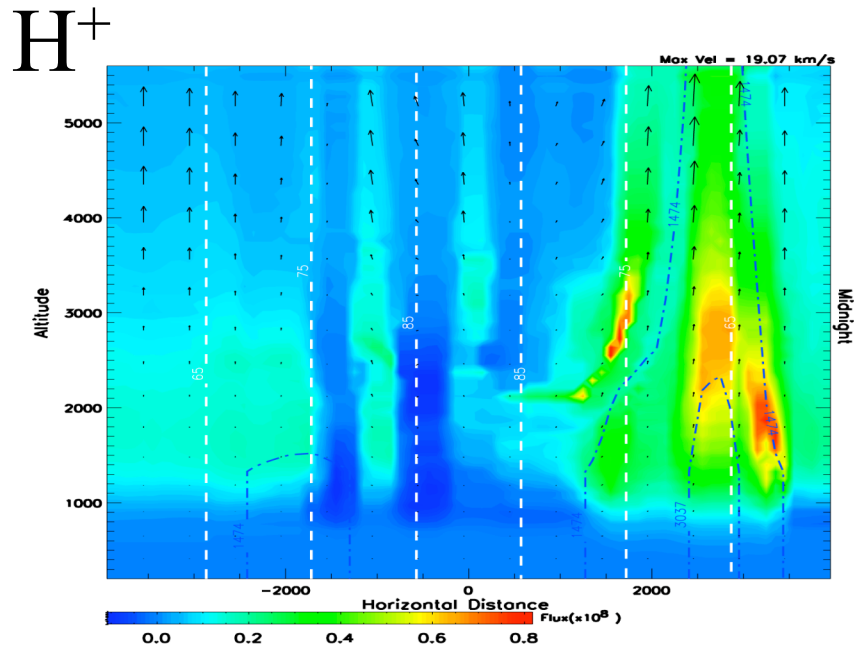

# Causes of Plasma Structures

- Changes in the Solar Wind Drivers
- Structured Electric Fields
- Structured Particle Precipitation
- Time Variations in E-fields and Precipitation
- Time Delays and Feedback Mechanisms in the M-I-T System
- Plasma Instabilities



$$-1 < B_y < +1; B_z < -1$$

12

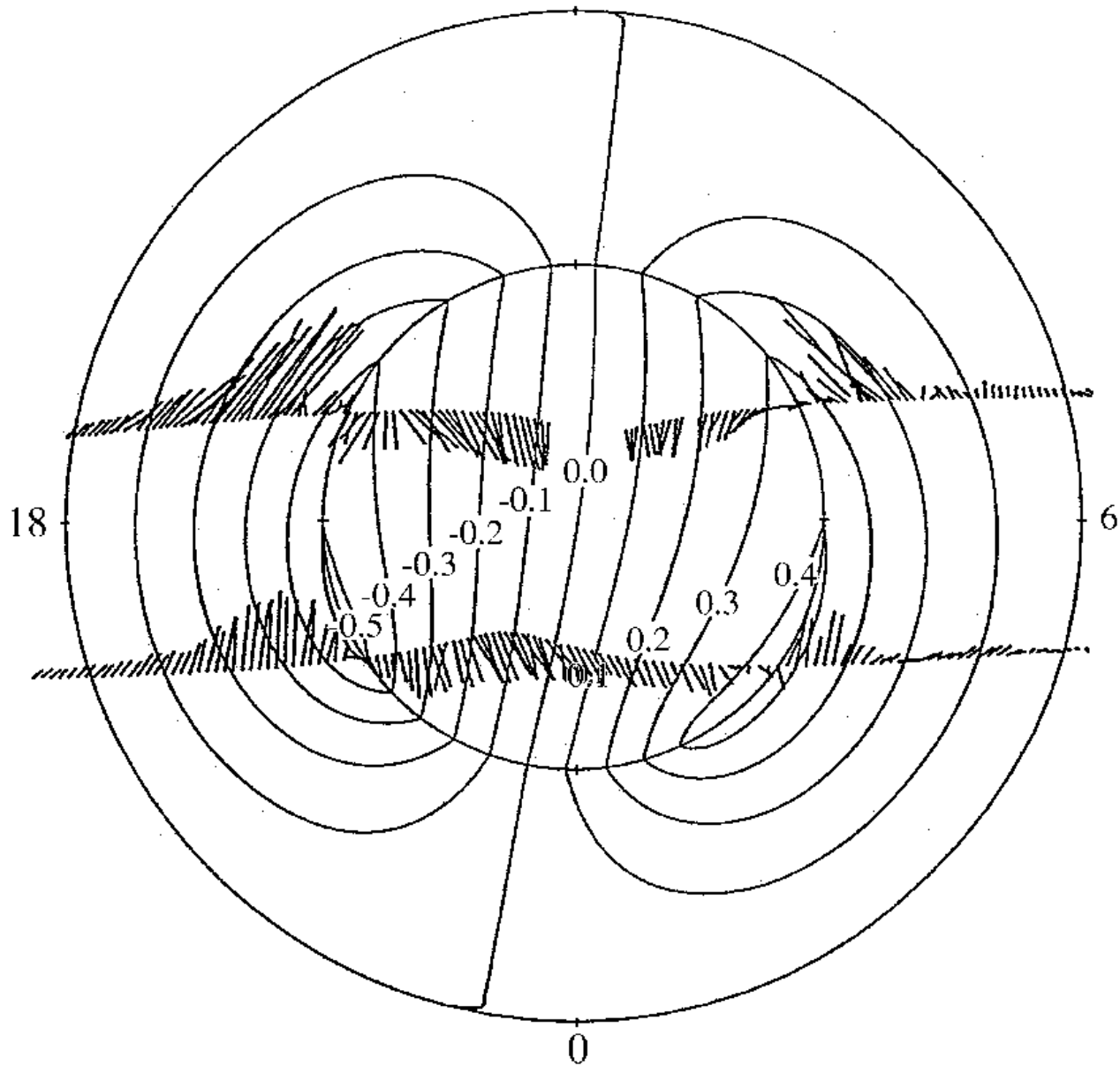

ION DRIFT METER, DE-2  
UNIVERSITY OF TEXAS AT DALLAS  
OCTOBER 17, 1981  
1634-1646 UT

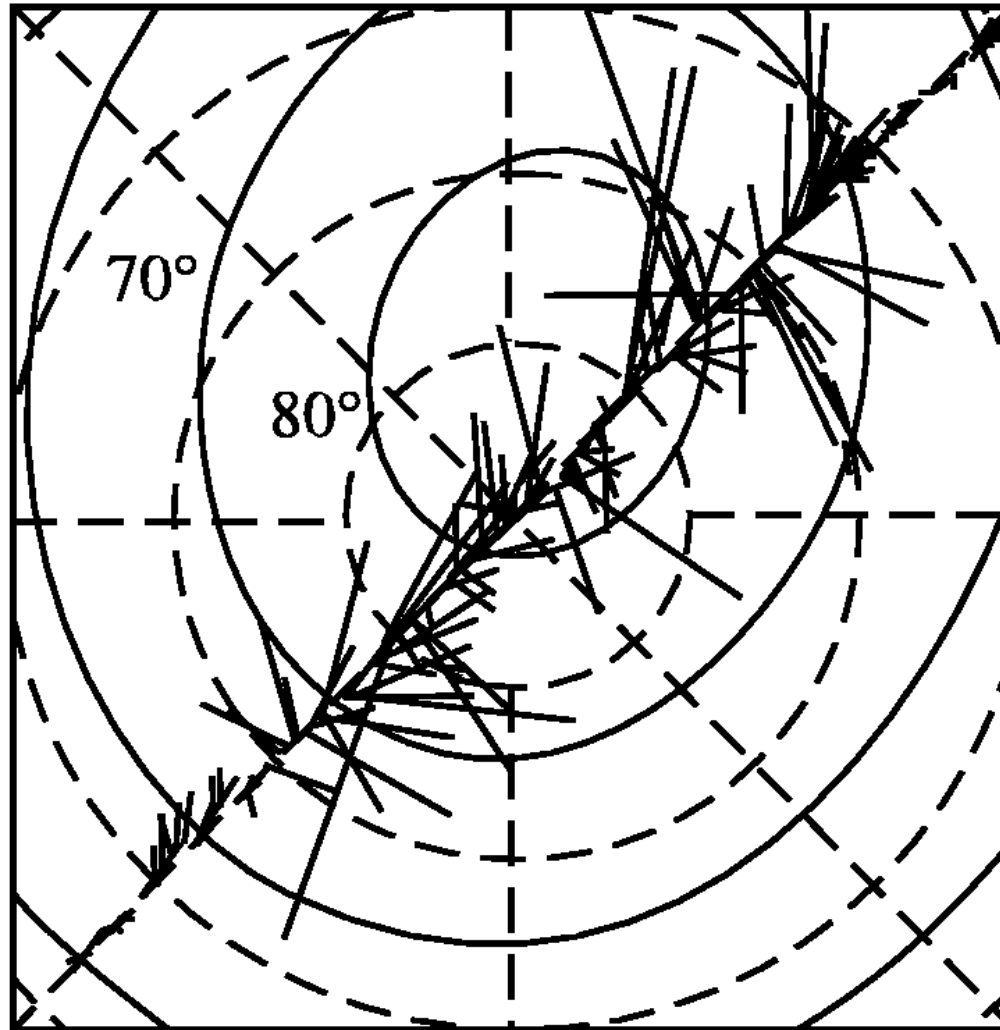

1 km s<sup>-1</sup>

**Greenland**

**100-300 km  
by  
1000-3000 km**

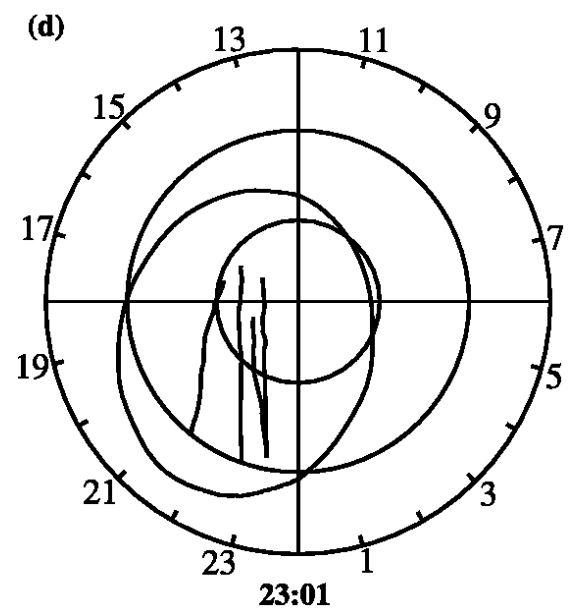
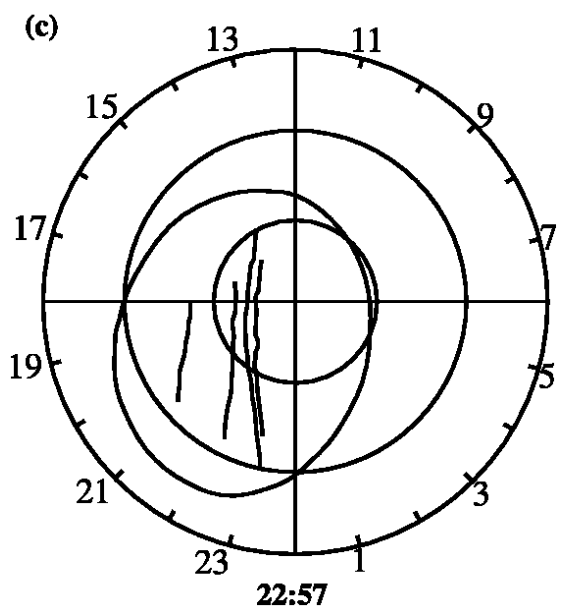
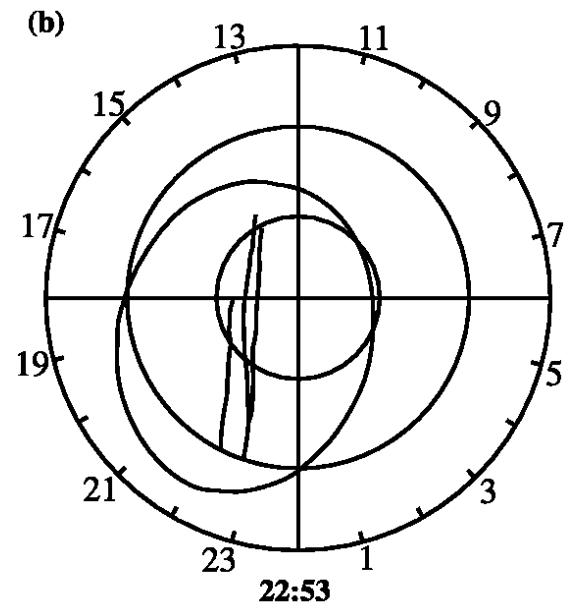
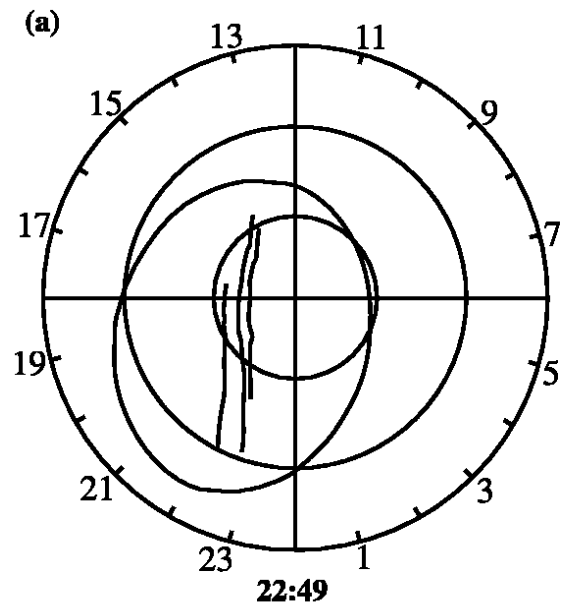

**Valladares et al (1994)**

1 MARCH 1982

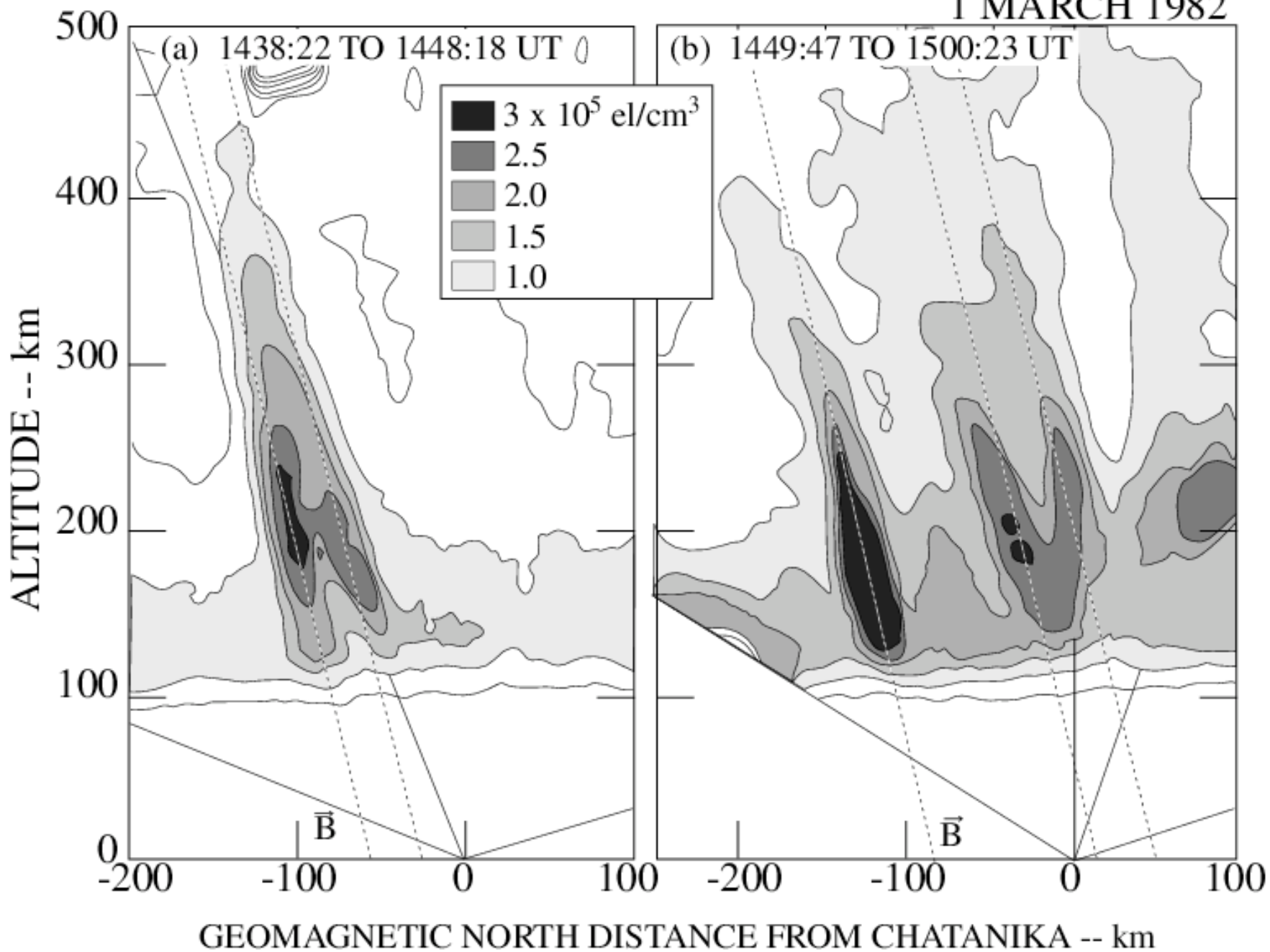

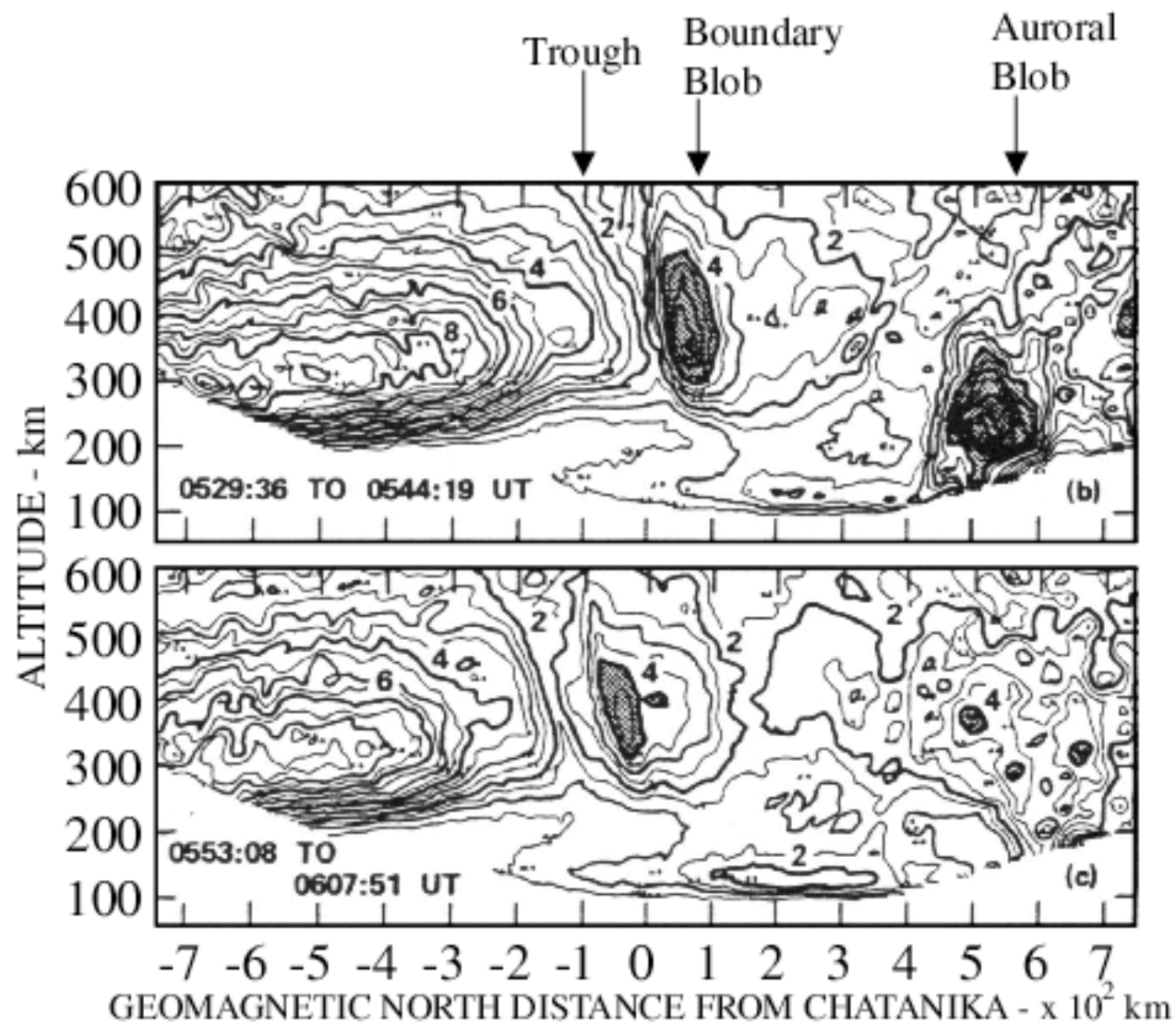

# Mesoscale Ionospheric Structures

- Propagating Plasma Patches
- Propagating Atmospheric Hole
- Propagating Polar Wind Jets
- Propagating Neutral Streams
- Sun-Aligned Polar Cap Arcs
- Theta Aurora
- Boundary and Auroral Blobs
- Stationary Polar Wind Jets
- Neutral Polar Wind Streams
- Sub-Auroral Ion Drift Events (SAID)
- Storm Enhanced Densities (SED) Ridges

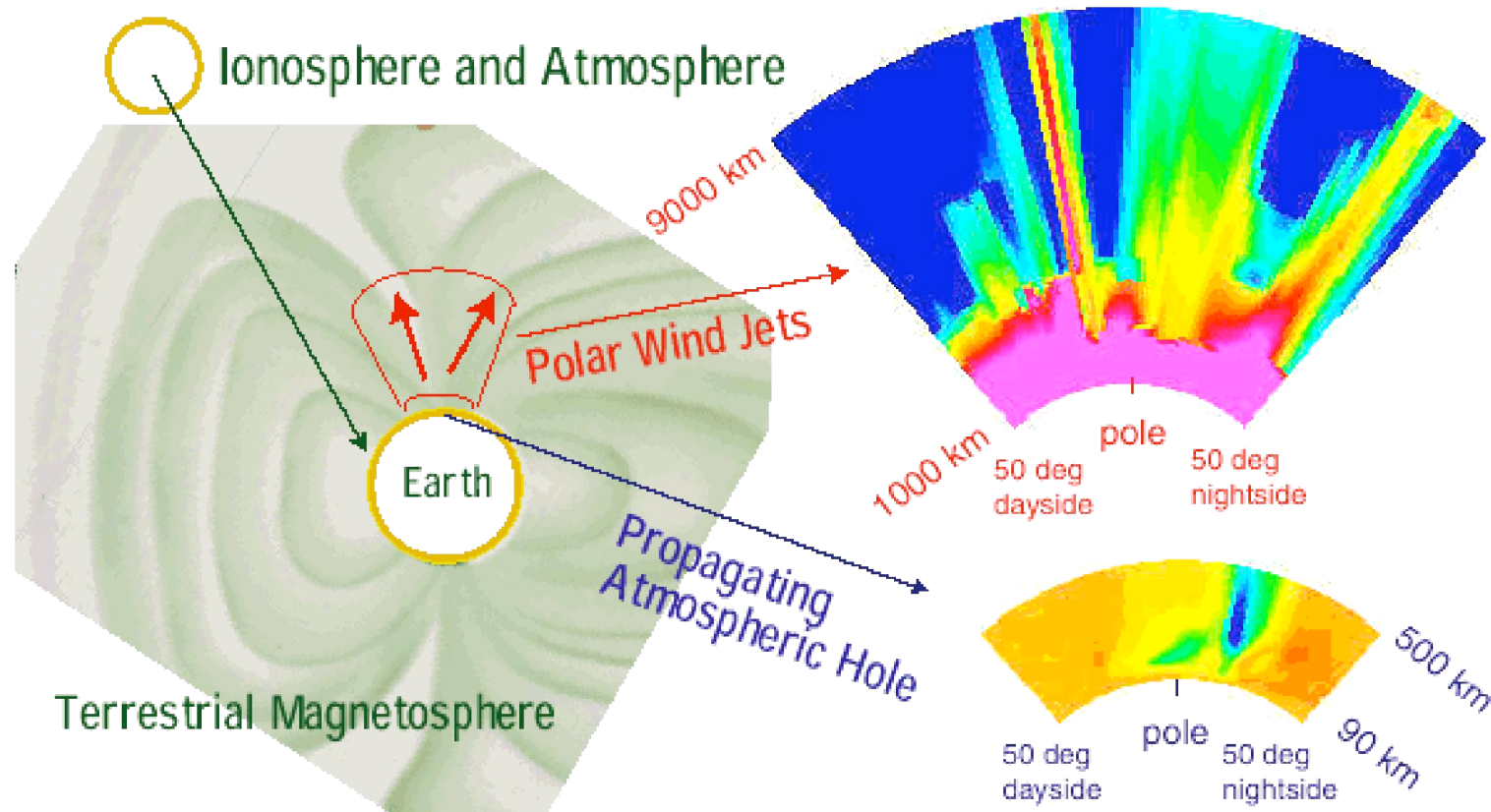

The near-Earth domain composed of the magnetosphere, polar wind, ionosphere and neutral atmosphere. Shown are propagating, supersonic, polar wind jets and propagating atmospheric holes.

# Propagating Plasma Patches

- Mesoscale Regions of Enhanced Plasma Density
- Created in or Equatorward of Noon Auroral Zone
- Antisunward Convection with Background Plasma
- Horizontal Extent of 200 - 1000 km
- Circular or Cigar-Shaped
- Single or Multiple Patches
- Density Enhancement of Few % to Factor 100
- Enhancement Extends Along **B**



## Single, Circular, Propagating Plasma Patch

- Gaussian Patch Distribution - 1000 km
- Peak  $N_e$  Factor 5 Above Background
- F10.7 = 150, Winter Polar Region
- Quiet Conditions, then Southward IMF & 100 kV at Time Plasma Patch Imposed
- Collisional Snowplow
- $N_n$  Depletion in and Behind Patch, Enhancement in Front
- Increased  $U_n$  in Patch
- Neutral Gas Upwelling and O/N<sub>2</sub> Changes
- Disturbance Moves Along with Patch

$t = 0$

$t = 1 \text{ hr}$

$N_e$   
300 km

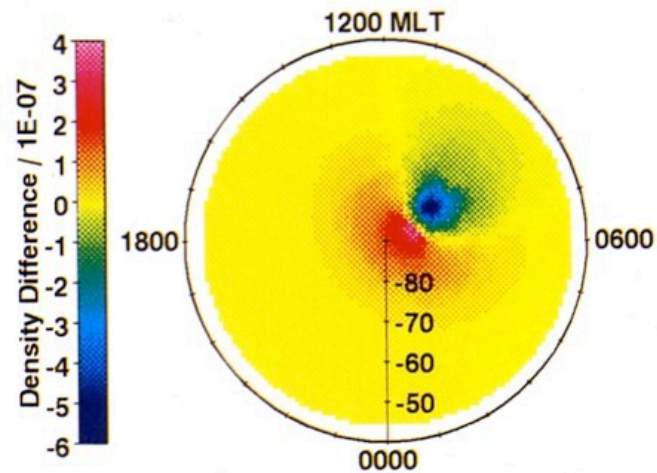
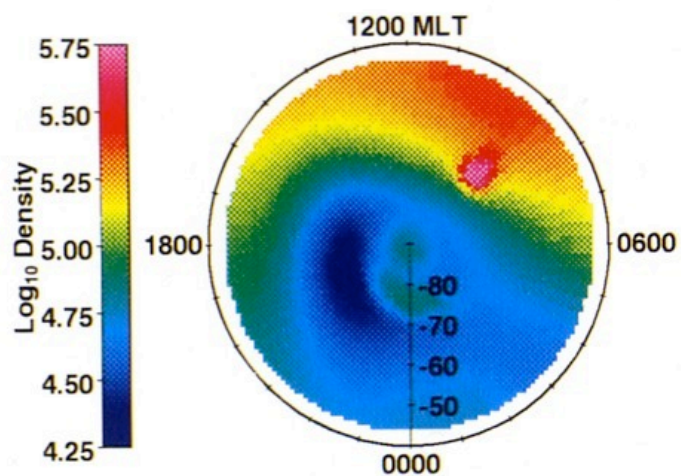

$\Delta N$

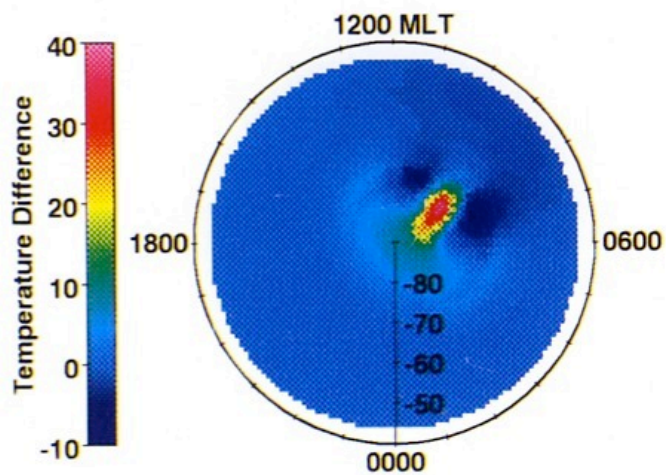

$\Delta T_n$

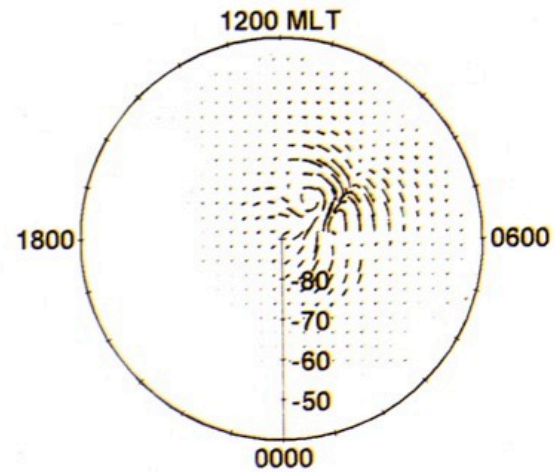

$\Delta U_n$

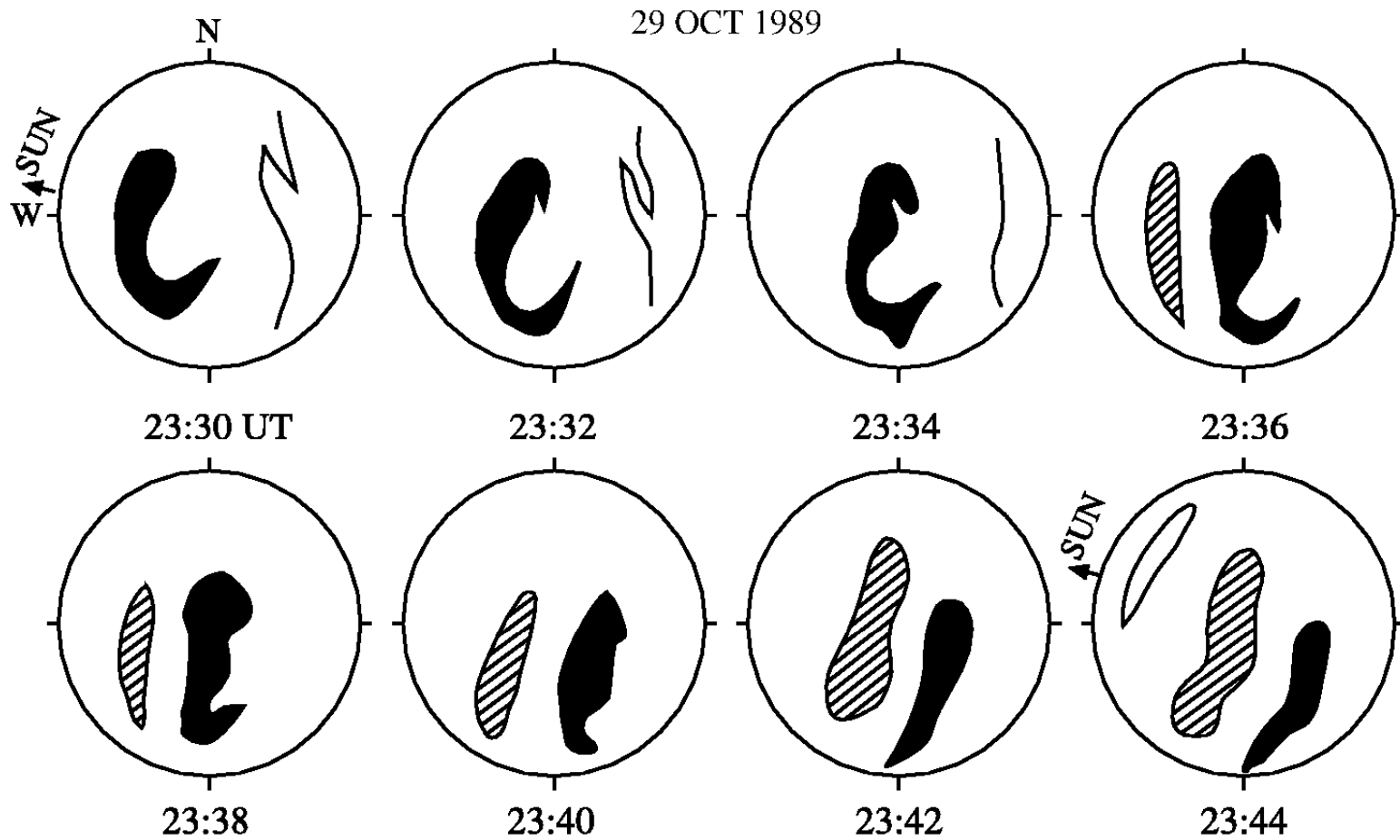

Qaanaaq, Greenland, October 29, 1989

All-Sky Images (630 nm)

2 - Minute Interval

t = 3hr

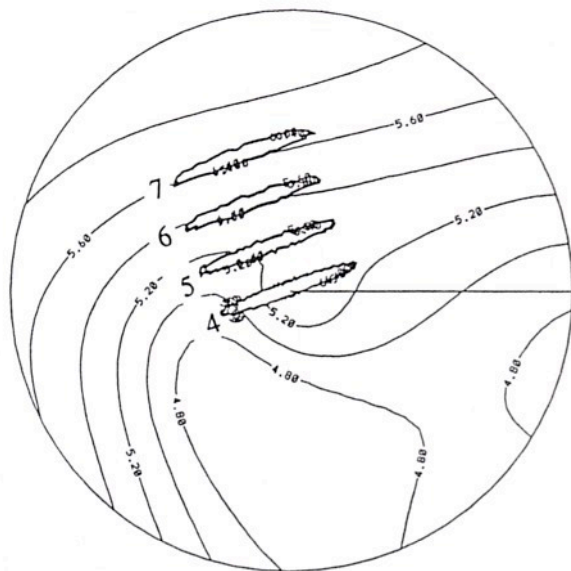

t = 3 hour

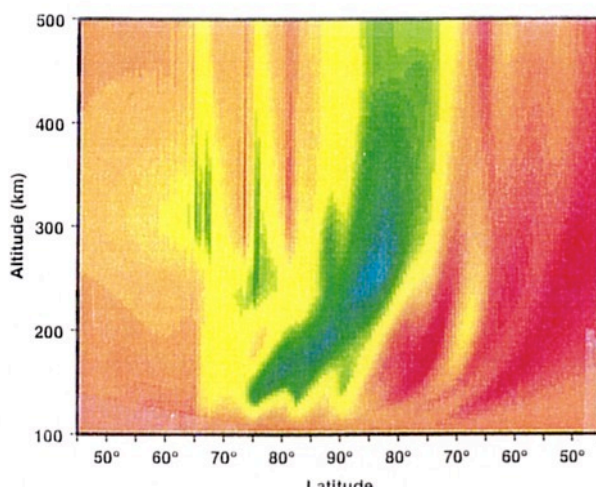
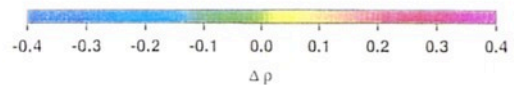
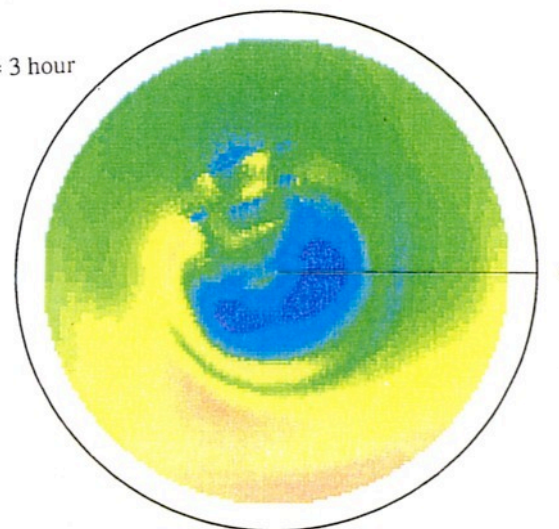

**Neutral Density  
Perturbation**

# Neutral Gas Perturbations

## 300 km

- Single, Circular, Propagating Plasma Patch
  - $\rho_n \sim 30\text{-}35\%$
  - $T_n \sim 100 - 300\text{ K}$
  - $U_n \sim 100\text{ m/s}$
- Multiple, Cigar-Shaped, Propagating Plasma Patches
  - $\rho_n \sim 30\%$
  - $T_n \sim 100 - 400\text{ K}$
  - $U_n \sim 150\text{ m/s}$
- Comparable to Day-Night Change in the Thermosphere at Mid-Latitudes

# MSIS Thermosphere

## Noon-Midnight Variation at 300 km Mid-Latitudes

- Solar Minimum, Winter Solstice
  - $\rho_n \sim 40 \%$
  - $T_n \sim 45 \text{ K}$
- Solar Maximum, Summer Solstice
  - $\rho_n \sim 50 \%$
  - $T_n \sim 250 \text{ K}$

# Propagating Polar Wind Jet

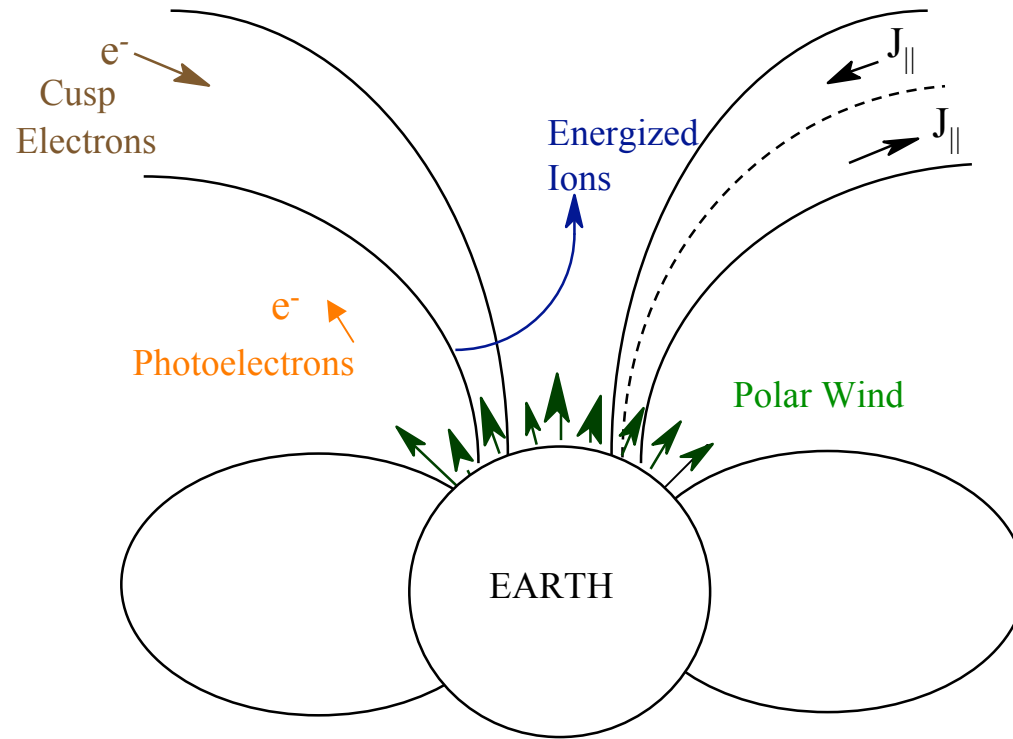

# $n(O^+)$ : 500 km, winter max

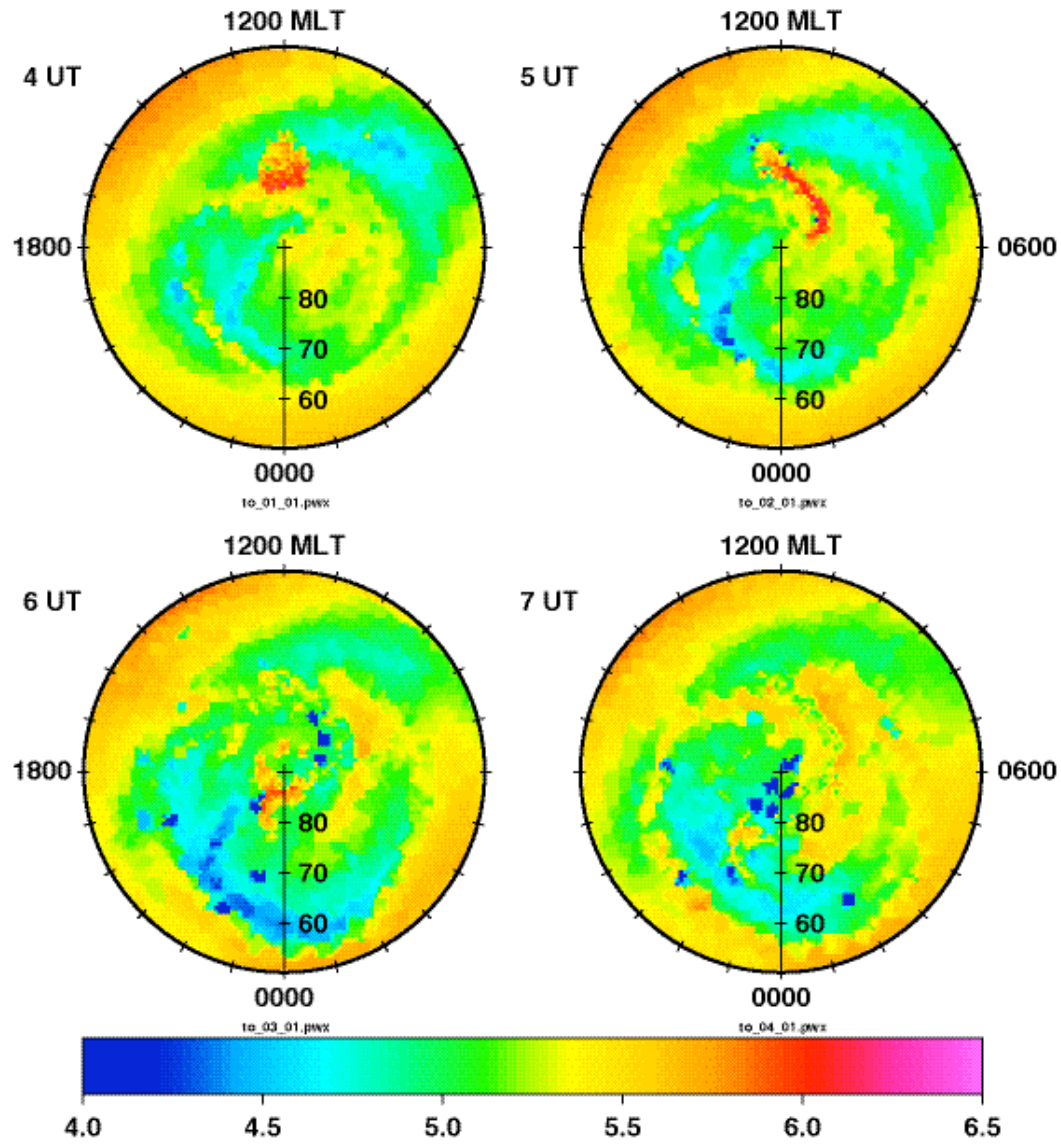



$n(\text{H}^+)$ : 6:00 UT, win max

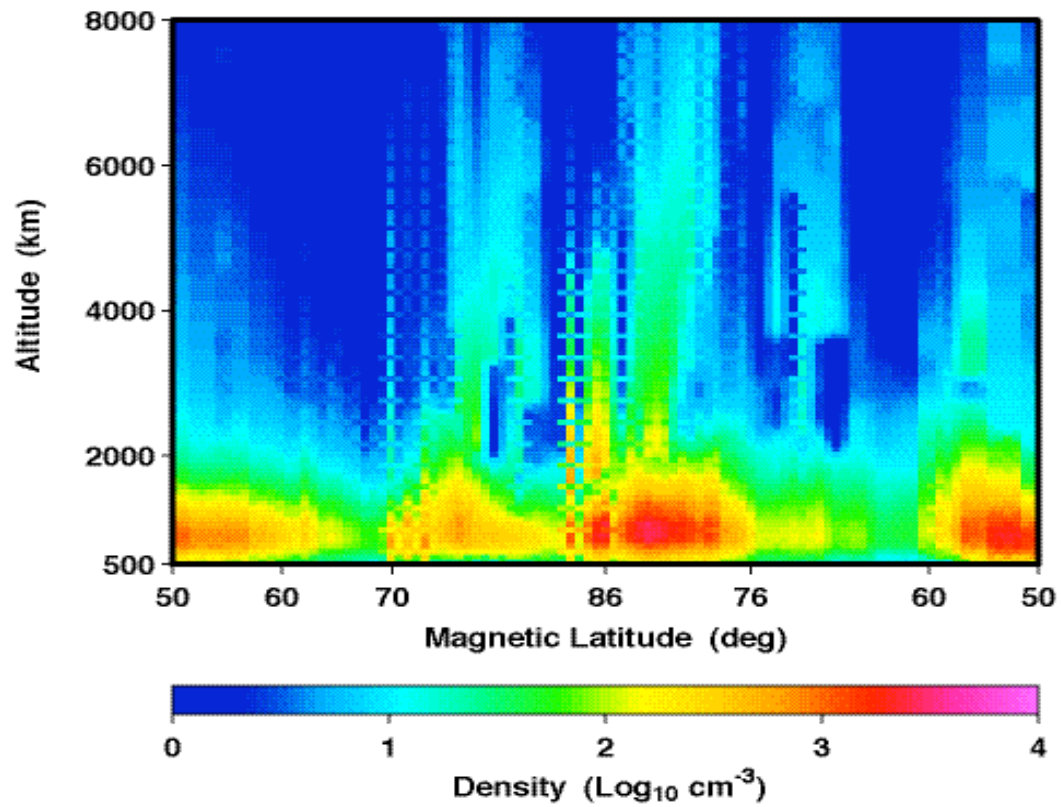

# Mid-Latitudes

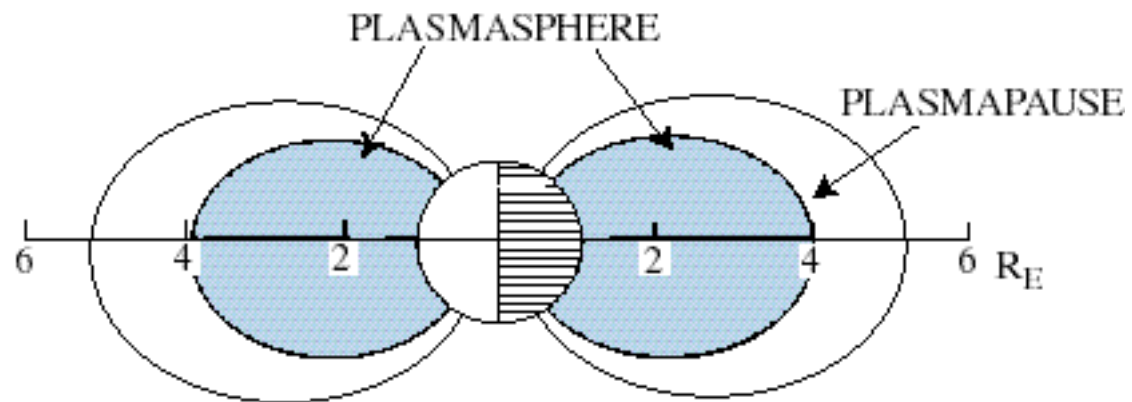
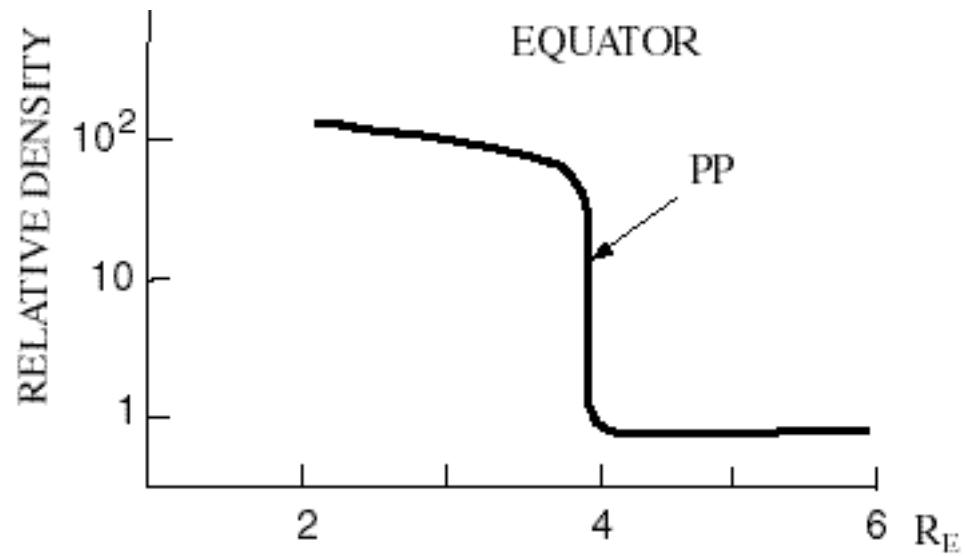

## Interhemisphere Flow

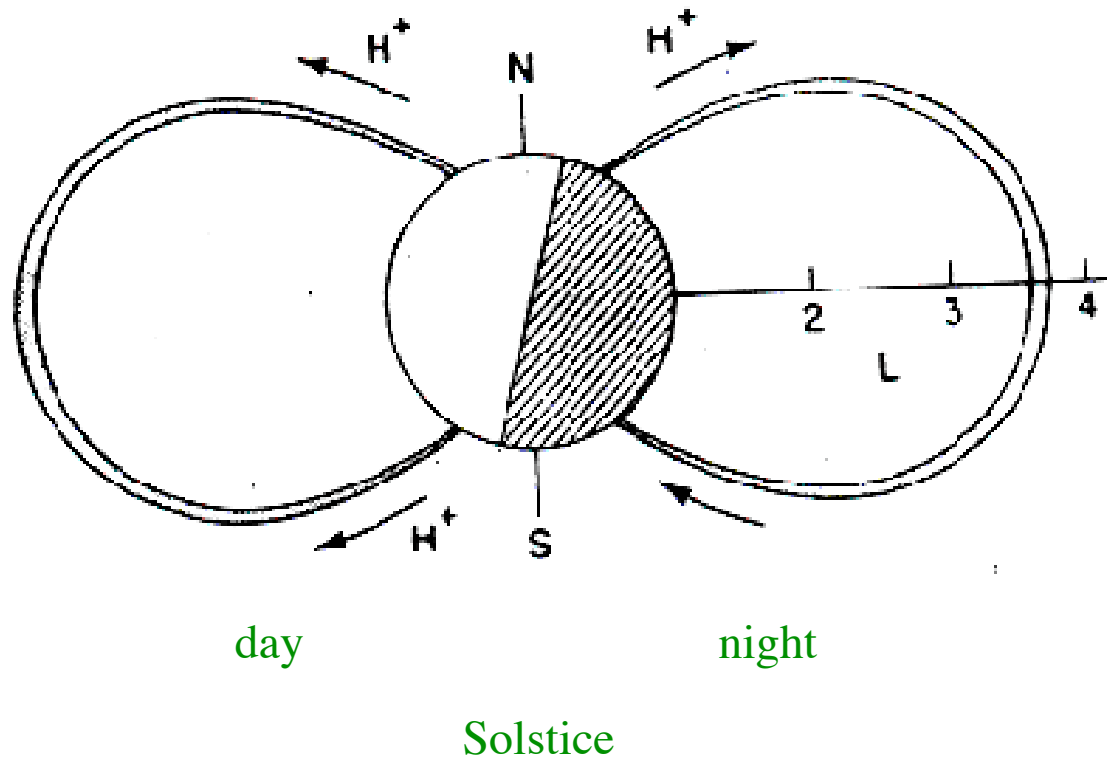

Evans and Holt (1978)

## Darrouzet et al (2006)

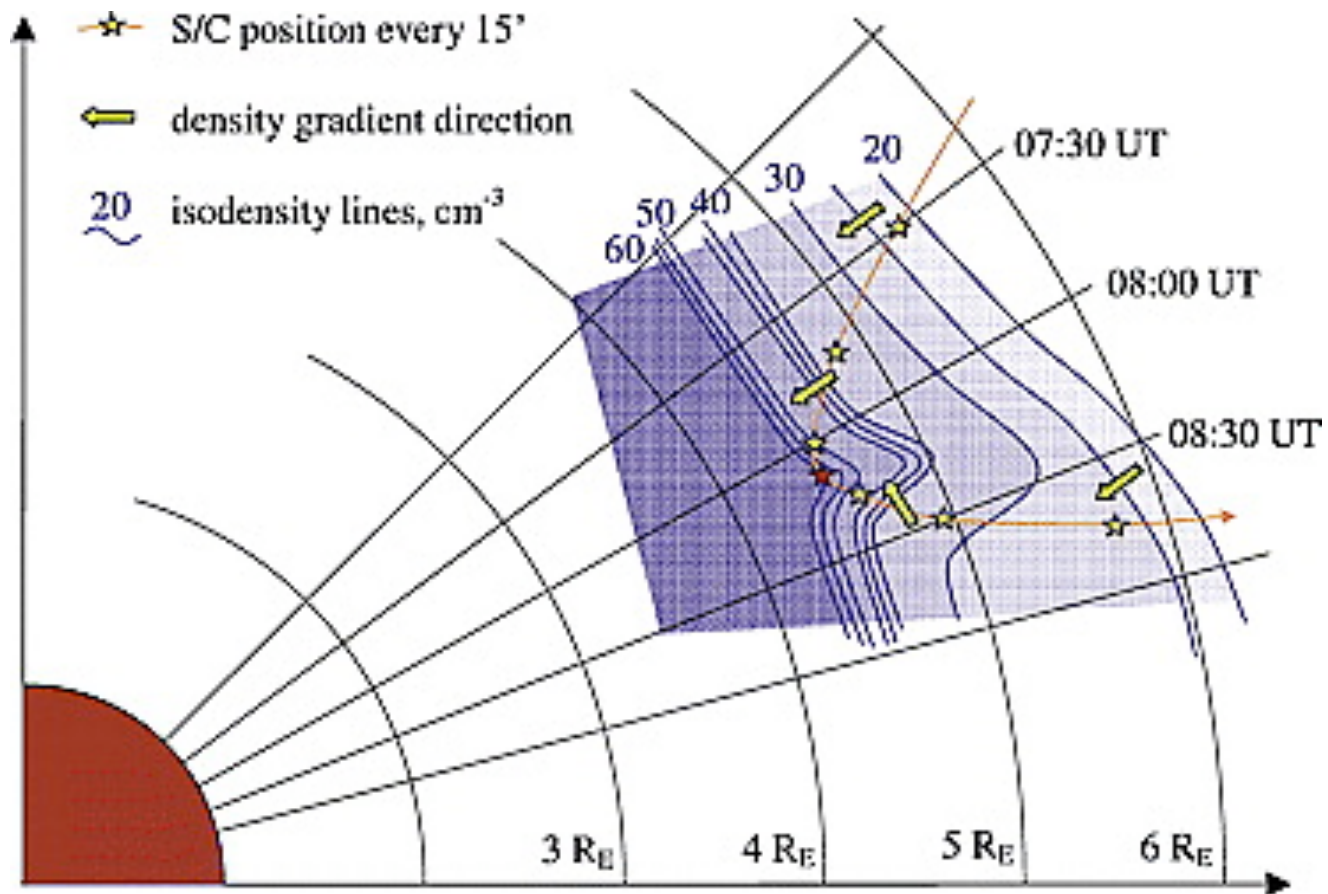

**Cluster Mission**

**Plasma Density Structures**

**Transverse Equatorial Size 20-5000 km**

# Gauss-Markov Kalman Filter Example

- **November 16, 2003**
- **GPS Ground TEC measurements from more than 900 GPS Receivers (from SOPAC Data Archive)**
- **Includes Receivers from:**
  - ➔ **IGS**
  - ➔ **CORS**
  - ➔ **EUREF**
  - ➔ **and others**



*"Bringing the pieces together"*

Global Assimilation of Ionospheric Measurements

Utah State University, (435)797-2962, schunk@cc.usu.edu;

Universities of Colorado (Boulder), Texas (Dallas), and Washington

# Gauss-Markov Kalman Filter Reconstruction

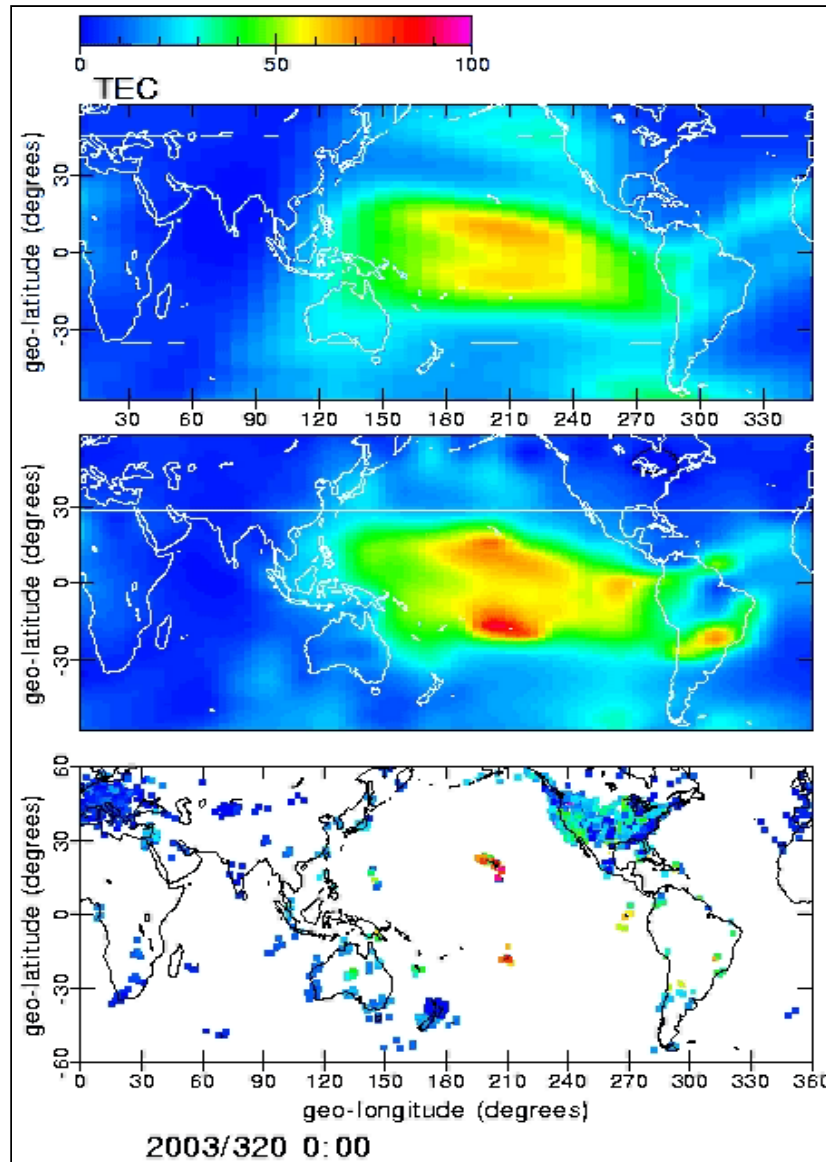

Climate

Kalman Filter

More than 3000  
Slant  
TEC Measurements  
are assimilated every  
15 minutes.



"Bringing the pieces together"

Global Assimilation of Ionospheric Measurements

Utah State University, (435)797-2962, schunk@cc.usu.edu;  
Universities of Colorado (Boulder), Texas (Dallas), and Washington

# Gauss-Markov Kalman Filter Example

## Regional Mode

- **3-D Ionospheric  $N_e$  Reconstruction over North America**
- **Large Geomagnetic Storm on November 20-21, 2003**
- **GPS Ground TEC Measurements from more than 300 GPS Receivers (CORS GPS Network + other) over the continental US and Canada**
- **2 Ionosondes at Dyess and Eglin**
- **Observe large TEC Enhancements over the Great Lakes during November 20, 2003 @ 2000 UT.**



*"Bringing the pieces together"*

Global Assimilation of Ionospheric Measurements  
Utah State University, (435)797-2962, schunk@cc.usu.edu;  
Universities of Colorado (Boulder), Texas (Dallas), and Washington



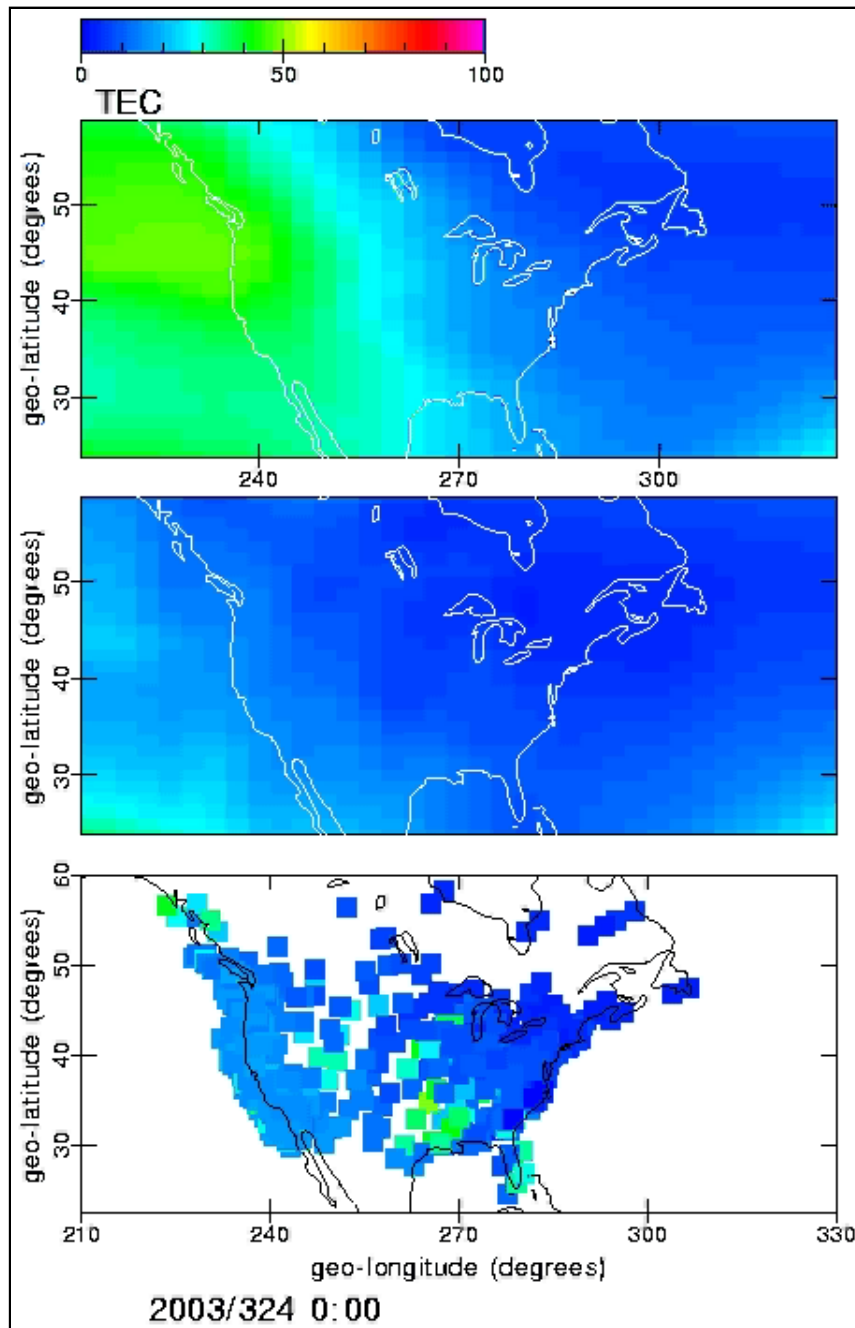

Climate

Kalman Filter

About 2000 Slant TEC  
Values are Assimilated  
every 15 min



"Bringing the pieces together"

Global Assimilation of Ionospheric Measurements

Utah State University, (435)797-2962, schunk@cc.usu.edu;

Universities of Colorado (Boulder), Texas (Dallas), and Washington

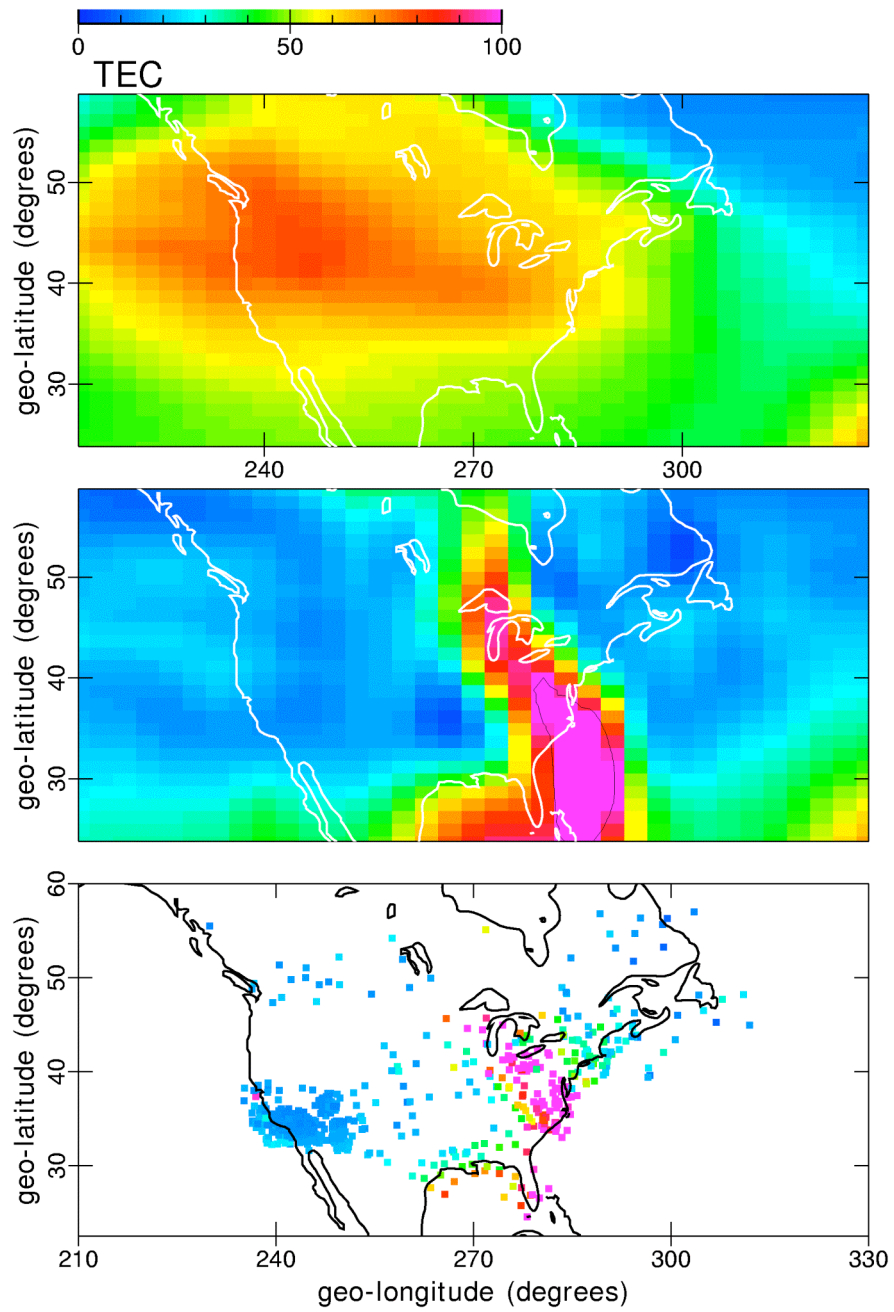

2003/324 20:00

Schunk et al. (2005)

## Eastward Electric Field Uplifts Equatorial Ionosphere

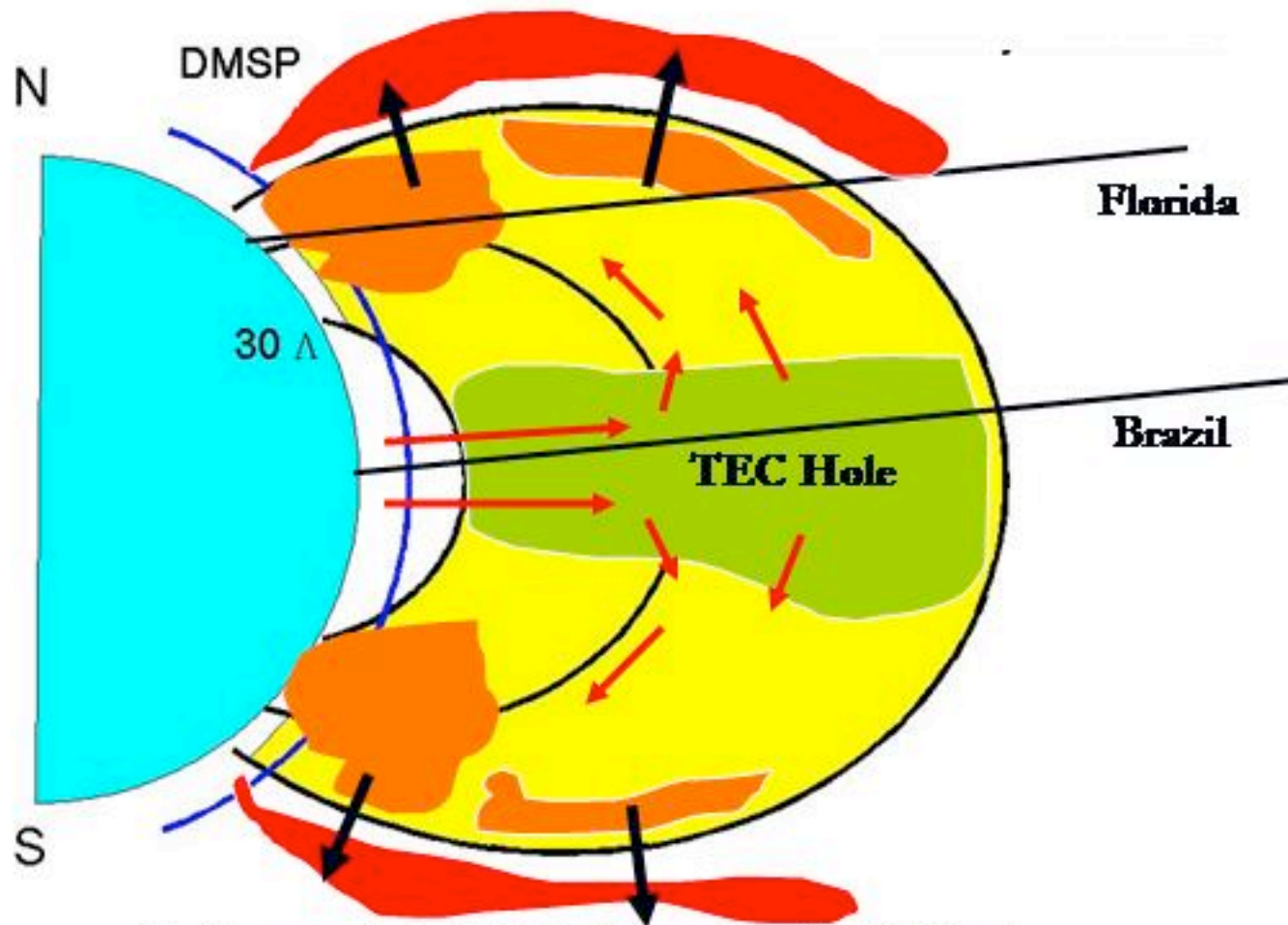

**Poleward SAPS Electric Field Strips  
Away Outer Layers of Plasmasphere**

Foster et al (2004)

# Low-Latitude Ionosphere

- Equatorial Anomaly
- $N_e$  Variability
- Spread-F/Plasma Bubbles
- Rayleigh-Taylor Instability

# IGRF Magnetic Field

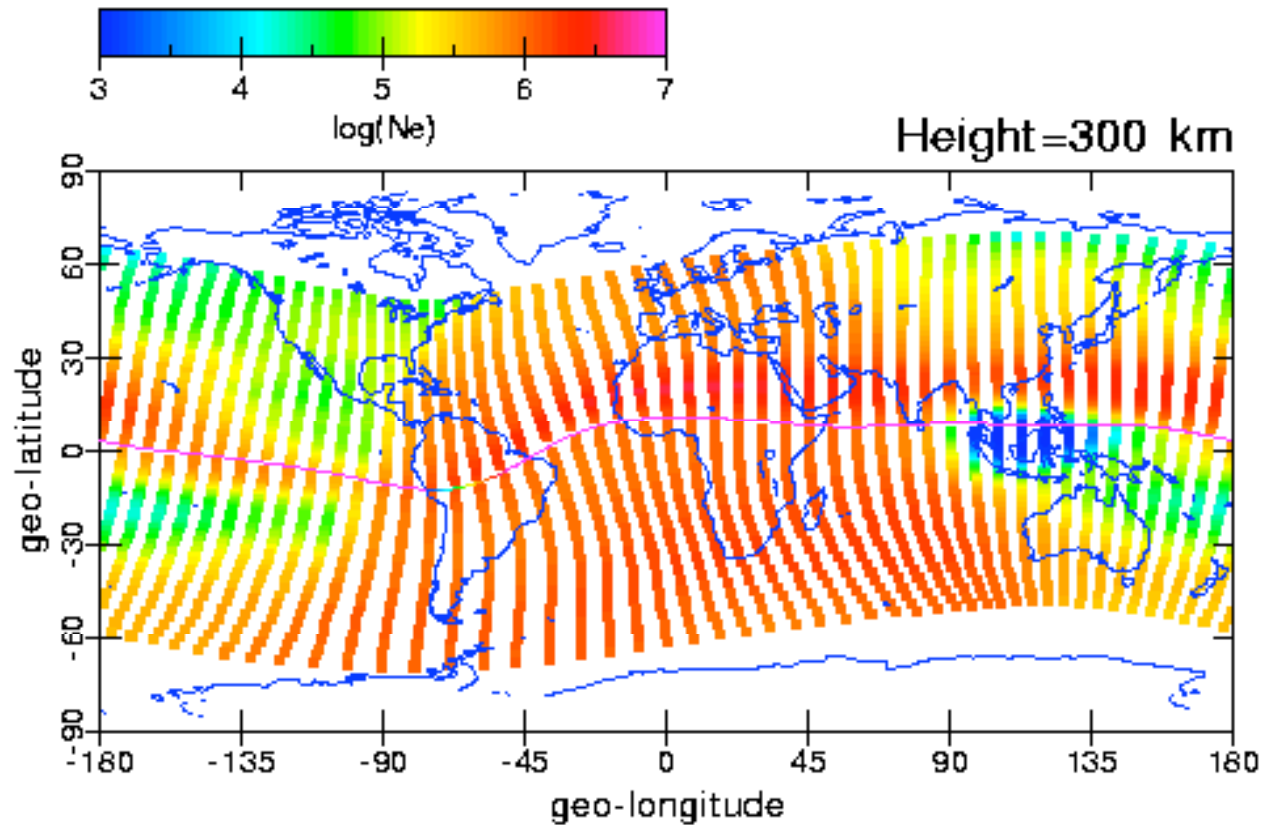

Snapshot of modeled electron densities at 300 km and 12 UT displayed in a geographic coordinate system. The electron densities were calculated from the Ionosphere-Plasmasphere Model (IPM) and are shown along geomagnetic field lines.

# Effects of Diffusion, Electric Fields, and Winds on the Low-Latitude Ionosphere

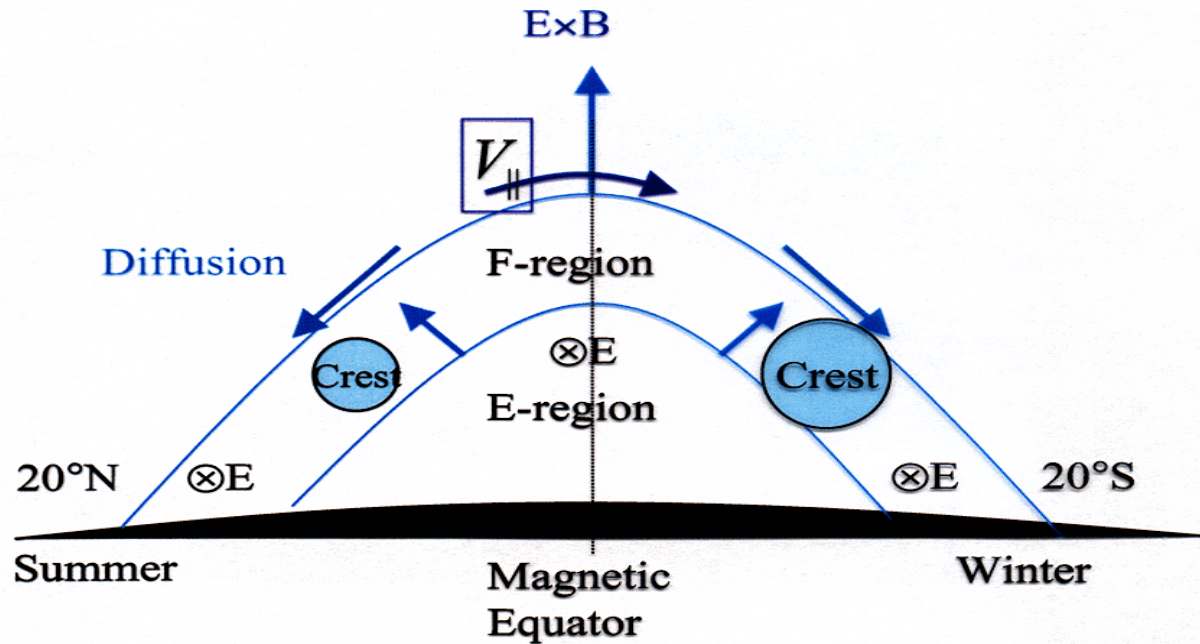

F-region Ionization Transport Process With the Transequatorial Wind

# Equatorial Fountain

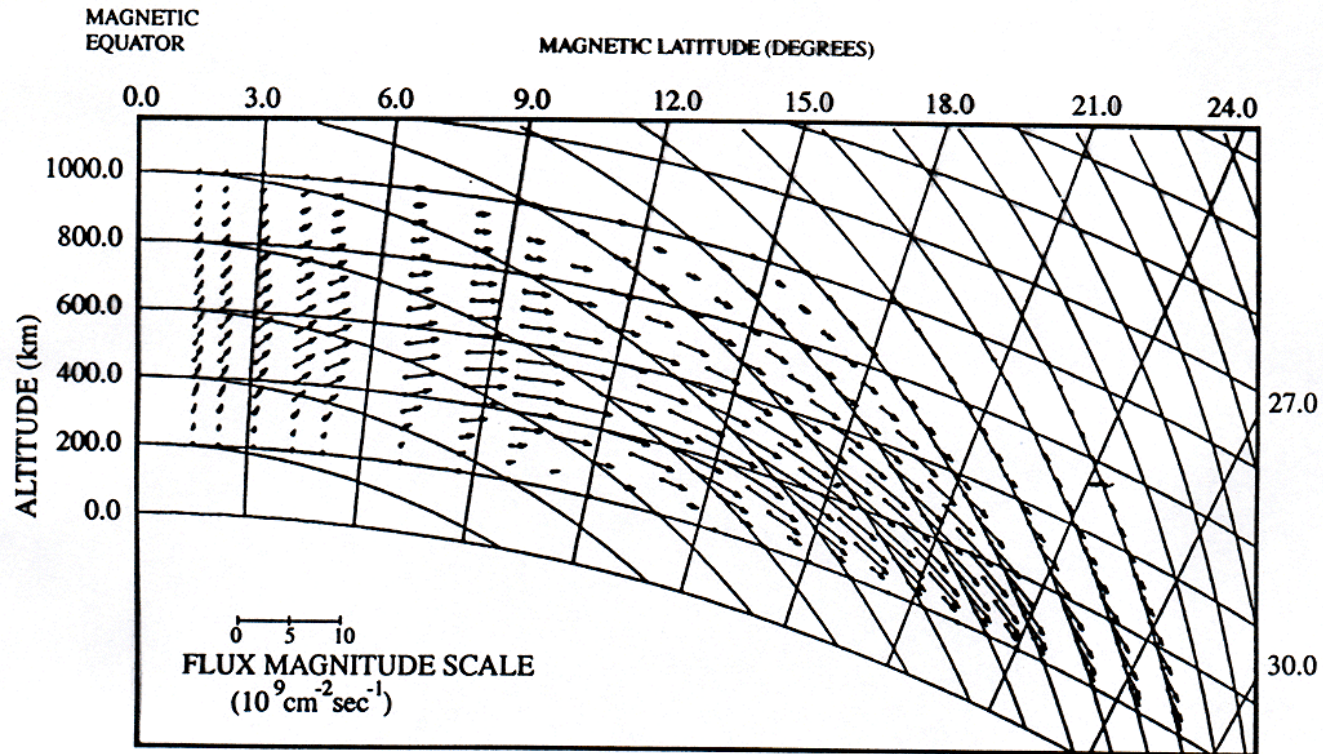

Hanson and Moffett (1966)

# Low Latitude Climatology

1998, Day 363, 1400 LT

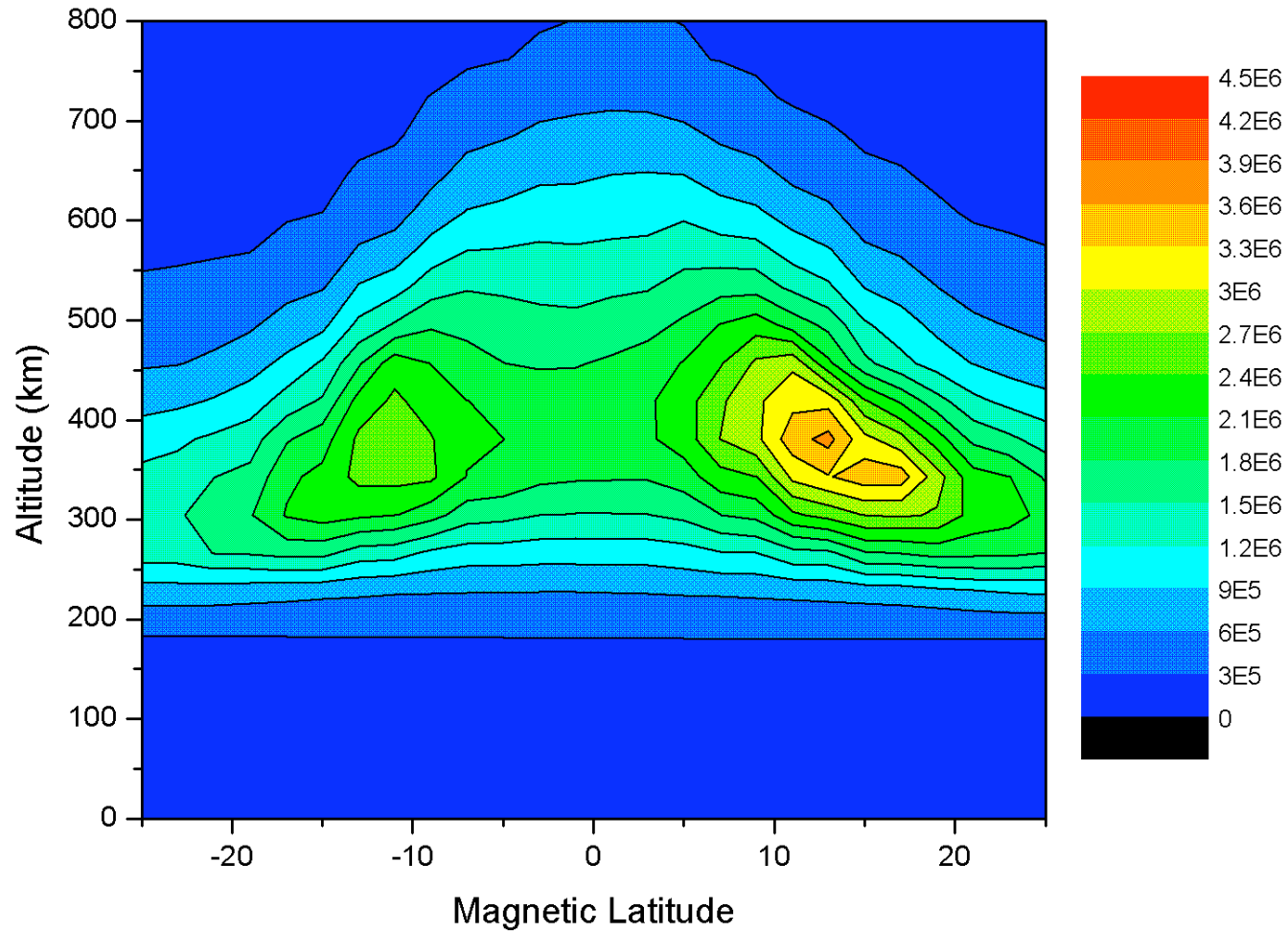



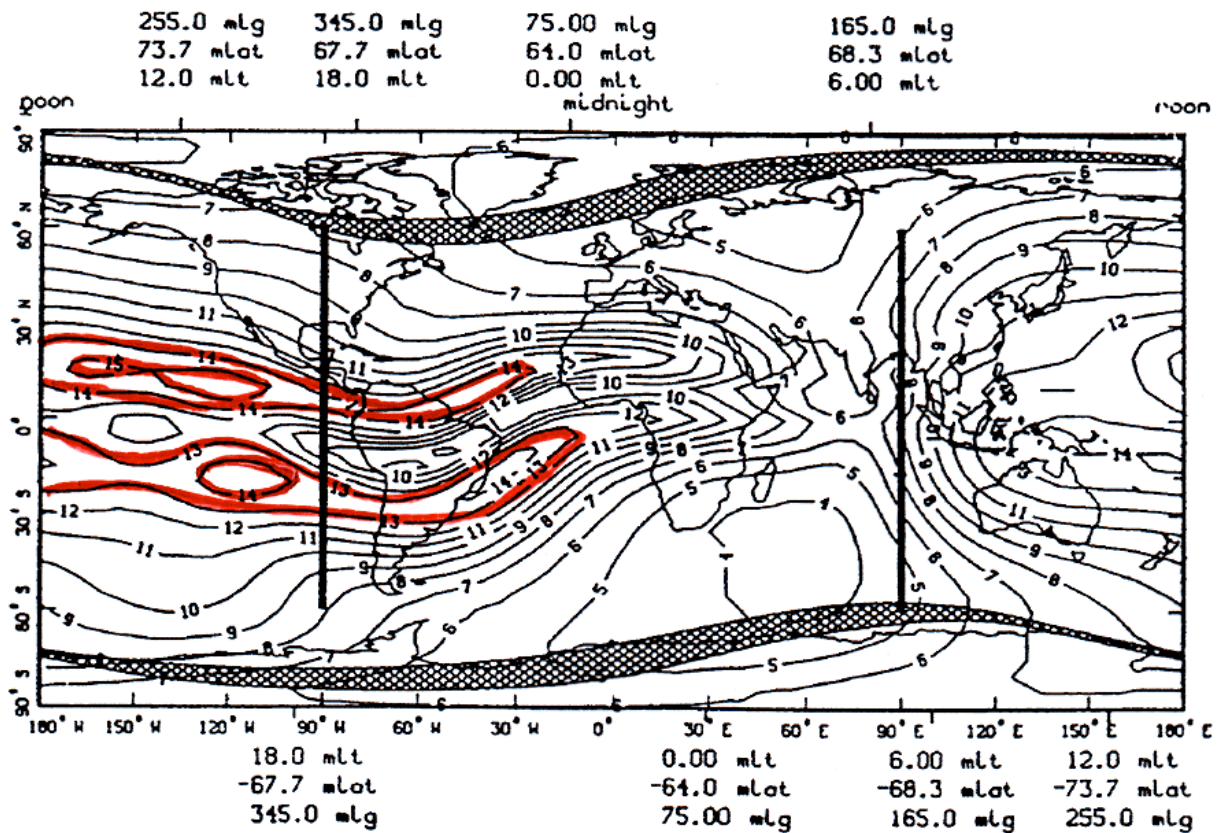

Bilitza et al. (1993)

- International Reference Ionosphere (IRI)
- $f_oF_2$  for solar Maximum, Equinox and UT=0

# GPS/MET Satellite

## Equatorial Profiles

$$-5^\circ \leq \theta \leq 5^\circ$$

$$1200 < \text{local time} < 1400$$

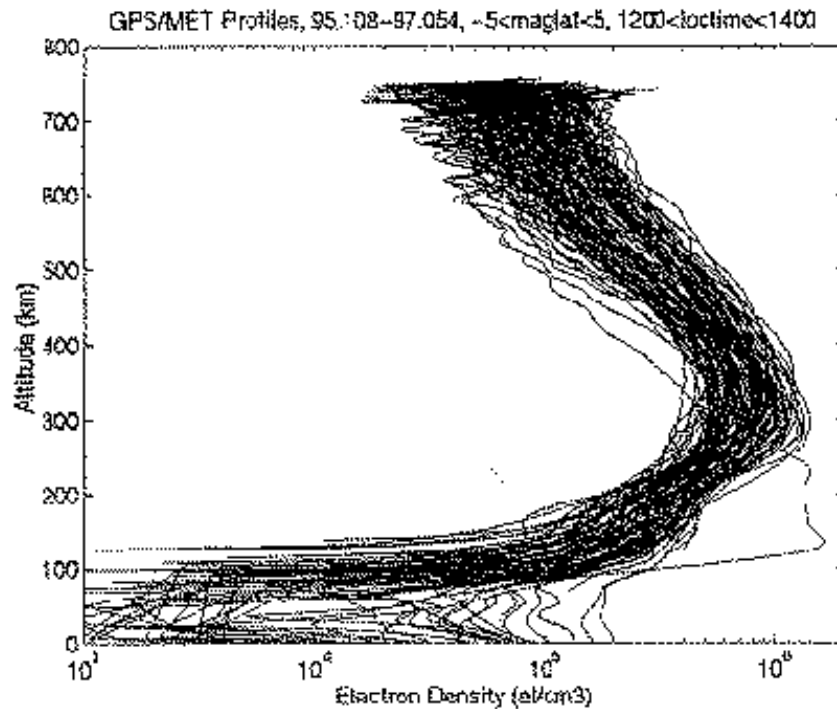

$$-5^\circ \leq \theta \leq 5^\circ$$

$$2000 < \text{local time} < 2200$$

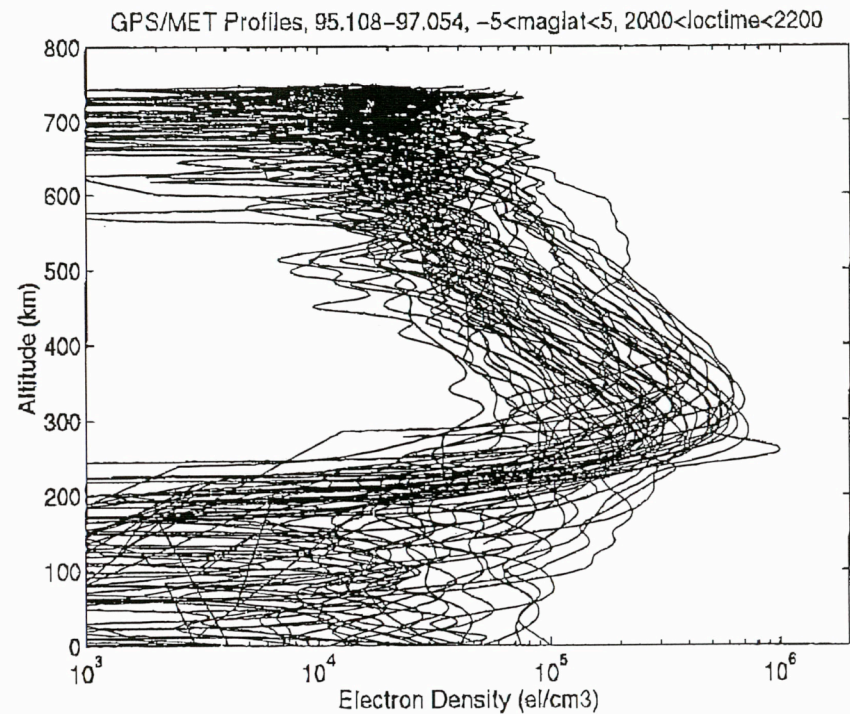

## Equatorial Plasma Bubbles

- Vertically Elongated Wedges of Depleted Plasma
- Entire North - South Extent of **B** Depleted
- Up to Factor 1000 Depletion
- Bubble Apex Altitudes Between 500 - 1500 km
- Typical Bubbles: 100-500 m/s up
- Fast Bubbles: 500 m/s - 5 km/s up  
1 km/s horizontal

# Spread F/Equatorial Bubbles

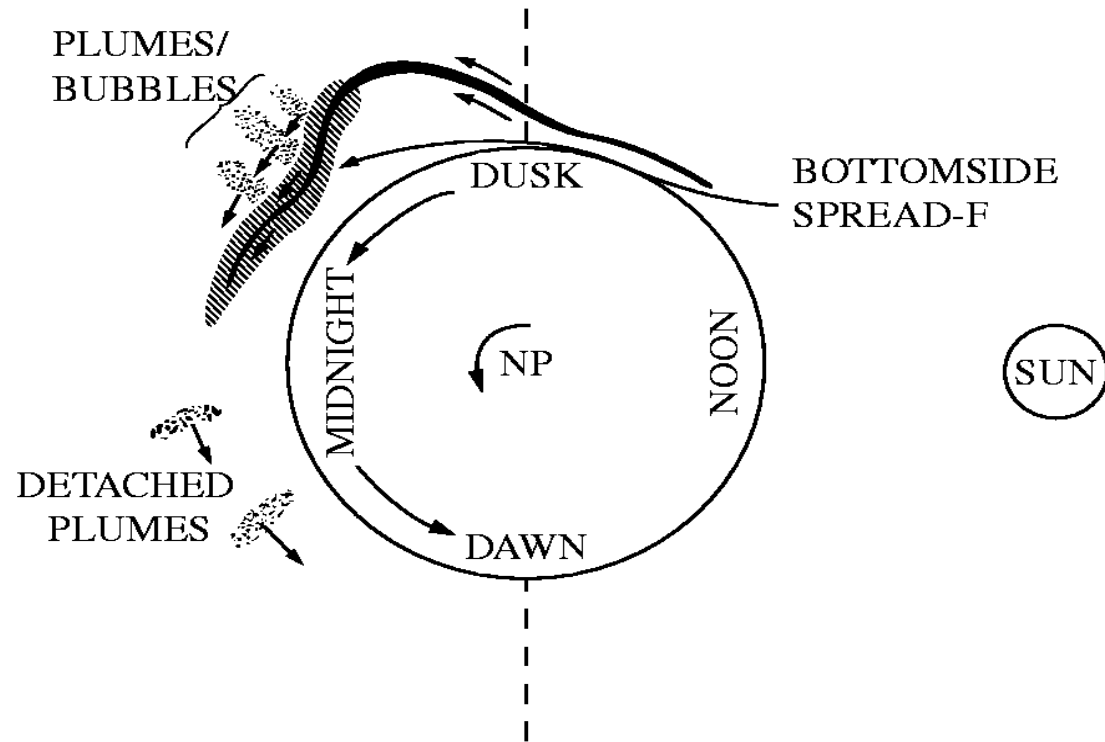

Argo and Kelley (1986)

# Equatorial Spread-F and Bubbles

## JULIA Coherent Scatter Radar

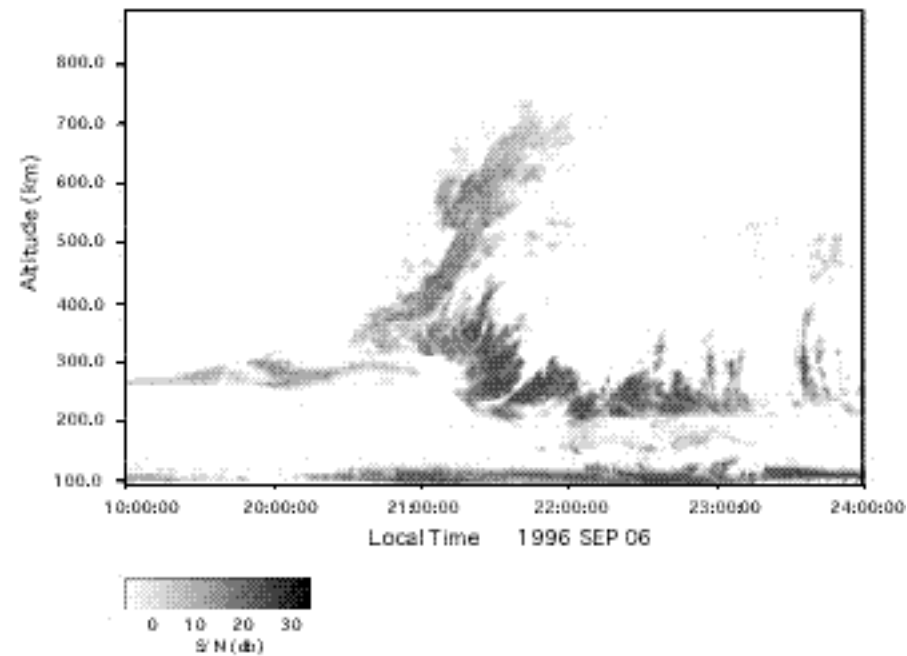

Hysell and Burcham (1998)

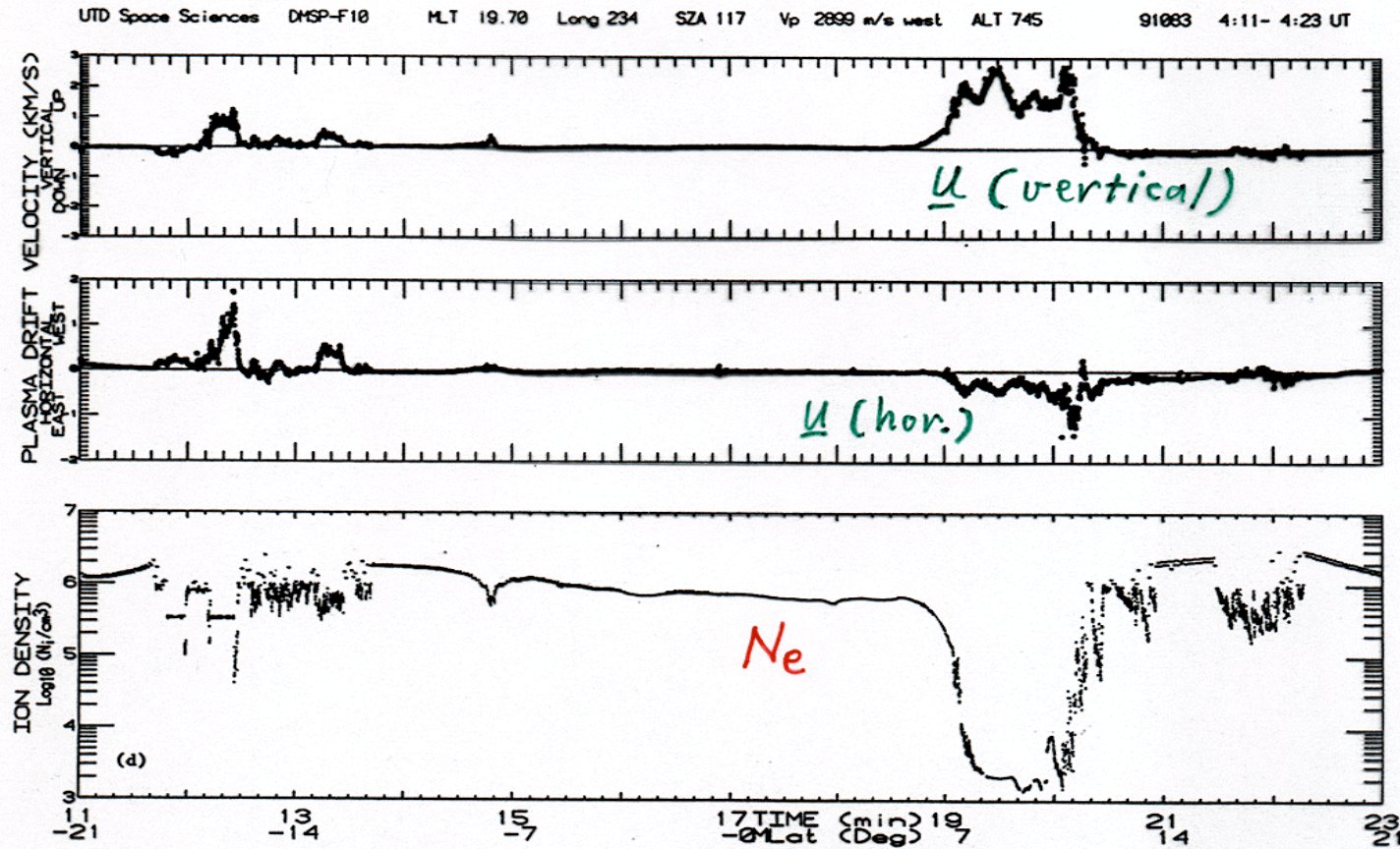

- DMSP F10 Satellite
- 234 E Longitude, 19.7 MLT, 117 SZA, 750 km Orbit
- Typical Bubbles: 100-500 m/s up
- Fast Bubbles: 500 m/s - 5 km/s up  
1 km/s horizontal

**Neutral Density  
(top) and  
Temperature  
(bottom)  
Perturbations  
due to 4 Plasma  
Bubbles**

**300 km**

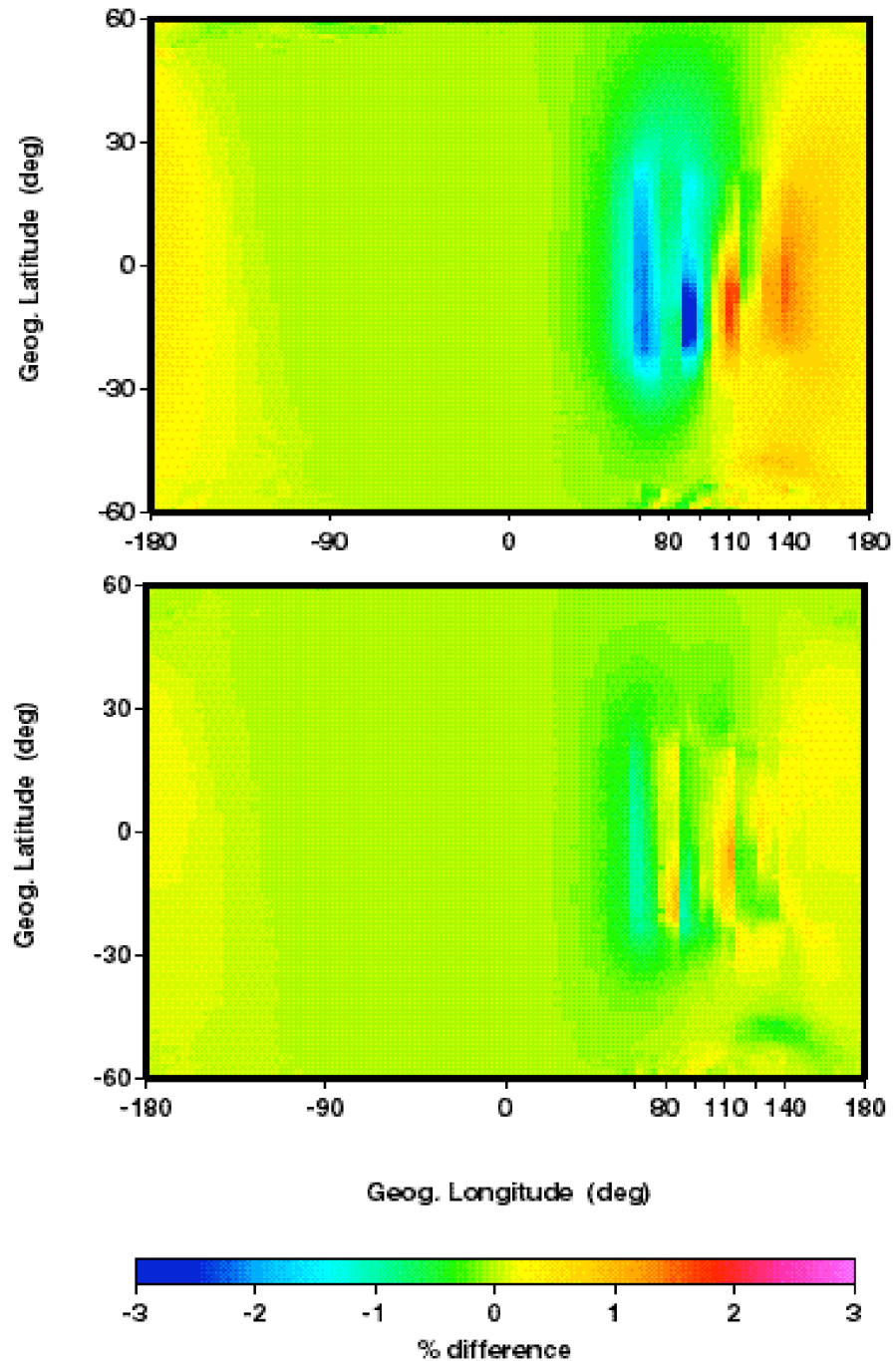

# Golden Age of Aeronomy

- Large Amount of Data Available
- Access via Virtual Observatories
- Data Assimilation Models
- Coupled Physics-Based Geospace Models
- Community Coordinated Modeling Center (CCMC)
- Elucidating Mass, Momentum, and Energy Coupling in the M-I-T System at Global, Regional, and Local Scales will be Possible
- Rigorous Inclusion of Instabilities in Global Models will be Possible