



DOI: 10.5281/zenodo.19297

## YAG-LASER CLEANING OF ARCHAEOLOGICAL MATERIALS IN JORDANIAN MUSEUMS

Wassef Al Sekhaneh, Abdulrahman El Serogy, Maha El-Bakri

*Faculty of Archaeology and Anthropology, Department of Conservation and Management of Cultural Resources, Yarmouk University, 21163 Irbid, Jordan*

Received: 06/04/2015

Accepted: 24/05/2015

Corresponding author: Wassef Al Sekhaneh (sekhaneh@yahoo.de)

### ABSTRACT

This study investigates new methods in the Jordanian museums in cleaning of ancient materials by laser cleaning of corrosion or patina products on archaeological corroded objects. This approach aiming to introduce a methodology for the optimal laser cleaning attitude in archaeological artefacts in Jordanian museums. It is study focused on the feasibility of YAG Laser in cleaning of Archaeological artefacts both organic and inorganic that covered with a corrosion or crust. The clustering of inclusion particles of the patina some are hard to remove by the procedure of conventional cleaning techniques, there is an apparent danger by use the traditional methods. These methods escalate the risk of the oxidised corrosion layer breaking away which will lead to loss of details about the the object and other important surface information. The advantage of using YAG pulsed lasers for cleaning of archaeological artefacts patina or corrosion. The laser technique is well precised controlled and can be cleaned layer by layer or localized. *Thus*, it is very significant to identify the chemical composition of the studied artifact surfaces before and after laser treatment. A series of laser cleaning studies has been done on test replica in the laboratory and artificially corroded.

---

**KEYWORDS:** *YAG Pulsed lasers; Archaeological artefacts; Surface cleaning; Organic materials and Inorganic Material; X-Ray Diffraction and Optical Microscopy.*

---

## INTRODUCTION

The light amplification stimulated emission of radiation (LASER) began in 1917 by Albert Einstein, In 1950, Frederic Kastler developed the optical pumping method of stimulating atoms, through which the light energy that stimulate the atoms is re-emitted (Encyclopaedia Britannica, 1986; Oakes, 2007). In 1951, Valentin A. Fabrikant obtained the patent right for amplification of electromagnetic radiation at low frequencies in the radiowave regions by the stimulated emission which is known as MASER (Microwave Amplification by Stimulated Emission of Radiation) (Lukishova, Bissell, Winkler, & Stroud, 2012; Ready, 1997). In 1964, Townes, Basov, and Prokhorov have the Nobel Prize in Physics in 1964 for their fundamental work in the field of quantum electronics, which has led to the construction of oscillators and amplifiers based on maser-laser principle (Ahmad Shazwi, 2008), In 1960 the physicist Ali Javan, William Bennet and Donald Herriot made the first gas laser using helium and neon. The semiconductor laser was proposed by Basov and Javan, the first laser diode 1962 was verified by Robert Hall, later in the same year Nick Holonyak made the first semiconductor laser emission in visible region. Then in 1964 Theodore H. Maiman invented the solid Ruby lase, later in the same year theNd:YAG and CO2 laser were invented, (Ahmad Shazwi, 2008; Nambiar, 2006). Strength and reliability of laser surfaces cleaning of various material organic and inorganic have been investigated not only for industrial purposes, but also for the cleaning of sensitive artwork surfaces in the conservation science (Francesco Bloisi, di Blasio, Vicari, & Zoncheddu, 2006; Martin Cooper, 1997; M. I. Cooper, Emmony, & Larson, 1992; MI Cooper, Emmony, & Larson, 1995).

Cleaning is usually the first step conservation and restoration process. It is one of the most difficult operations commenced when preserving archaeological objects. Any cleaning must be carried out with great high consideration of the Experiments have essentially been done on original objects with distinct cleaning challenges, leading to conclusions valid only for restricted material compositions in combination with special surface phenomena (F Bloisi, Barone, & Vicari, 2004; Mottner, Wiedemann, Haber, Conrad, & Gervais, 2005). In the last decade, interests were focused on more sophisticated research concerning the interaction between laser energy and surface layers of the materials particularly the archaeological ones (Kobayashi, 1999; Tam, Leung, Zapka, & Ziemlich, 1992). Systematic investigations including laser treatments of artificial model samples have been performed successfully on stone or marble (M. I. Cooper et al.,

1992; MI Cooper et al., 1995; S Klein et al., 2001), and stained glass or sand stone (Fekrsanati et al., 2001; Stefan Klein, Hildenhagen, Dickmann, Stratoudaki, & Zafirooulos, 2000), hard tissue as bone and ivory (Koss et al., 2008; Landucci, Pini, Siano, Salimbeni, & Pecchioni, 2000). The work on archaeological materials both organic and inorganic in our laboratories undertaken here follows the replicas experimental arrangement, then the technique is applied to original objects in the same setting of the replicas. There exist many types of laser; they are normally classified depending on the active medium, which consists of atoms, molecules or ions which may be solid, liquid or gaseous states (table 1) (Ghatak, 2009; Khare & Swarup, 2009; Thyagarajan & Ghatak, 2010).

**Table 1.** Types of laser and the active medium.

Laser Type	Active Medium
Solid State Laser	Ruby
	Nd:YAG
	Nd:Glass
Liquid Laser	Dye
Gas laser	He-Ne
	CO2
	Argon

When the atoms of active medium supplied with pumping energy, it takes on a state of excitation ( $E_1 < E_2$ ) (Fig. 1a and Fig. 2a) and population inversion can be created leading to emitting the stored energy again in diverse ways (Fig. 1b and Fig. 2b) Before sending out part of the emission energy in a form of laser radiation through the resonator (Fig. 1c and Fig. 2c) (*Atom, Laser And Spectroscopy*; Csele, 2011; *Introduction To Solid State Physics, 1/e*).

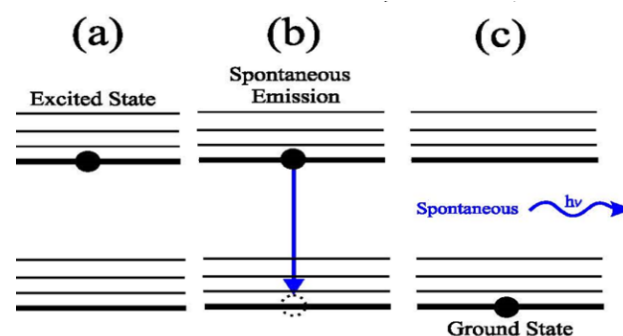

**Figure 1.** Spontaneous emission a.) Exited electron b.) Ground state electron. c.) Emitted photon

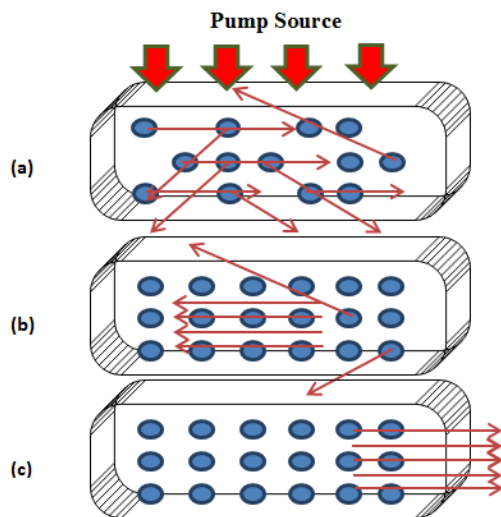

**Figure 2.** Active medium atoms excited by pump energy. (a) Atoms in an excitation state. (b) The excited atoms stimulated other atoms. (c) Laser radiation.

The active medium should have a metastable level to allow the excited atoms a longer lifetime nanoseconds before relaxation from higher energy level to lower energy level (*Engineering Physics*, 2010; Subrahmanyam, Lal, & Avadhanulu, 2004). Once the energy is absorbed by the atom, the atom can return to ground state and lose its excess energy by re-emission. Normally, an excited atom stays at the higher level for only a very short time nanosecond second (Wiersma & Lagendijk, 1996). Thus, this transition occurs without any external effects or any powerful source in a process called Spontaneous Emission (Fig. 1 and 2). Noting that: (i) the energy of an emitted photon is equal to the energy gap between levels  $h\nu = \Delta E$ , where ( $h = \text{Planck's constant}$ ,  $\nu = \text{frequency}$ ); (ii) the photon is emitted in a random direction, in any phase and within a range of frequency (Csele, 2011).

The interaction of various material surfaces with laser beam is depend on the composition of the surface and the type of laser, focusing beam on the surface cleans the deposits such as the corrosions patina caused by outdoor or indoor weathering particularly in high concentration of hazard gases, aged preservation coatings, dirt deposits, traces of paint, lime or rust. The experiments are mainly intended for cleaning challenges denoted by model objects, consisting of bone, copper, bronze, stone,, and marble with comparable surface corrosion as well.

Copper and bronze materials suffer from various corrosion processes caused by atmospherical influence of hazard gases or air pollutants such as  $\text{NO}_x$ ,  $\text{SO}_2$ ,  $\text{CO}_2$ ,  $\text{O}_2$ , water, soot, gypsum, and silica. Most of the outdoor placed objects show different

corrosion circumstances and damage spectacles at various regions of the artifact surface mostly depending on the distinguishable range of influence of wind and water (Meyer, 1964; Schikorr, 1963; Stöckle, Fitz, Mach, Pöhlmann, & Snethlage, 1993; Stöckle & Krätschmer, 1998; Strandberg, Johansson, & Lindqvist, 1997; Wiederholt, 1964). The archaeological artifacts present various contaminates, typically appearing as superficial formations, alterations and encrustations which harm the aesthetic value of the artifacts owing to both the products of the material corrosion and on the type of the surrounding environment of objects which can cover the object surface with deposit consisting of various micro-particles (soot, pollens, windborne). Surface contamination can be categorized into two types: foreign matter (loose) and product of alteration or corrosion (fixed). In loose contamination, the contaminant particles are attached to the substance surface by weak attractive forces. In fixed contamination, they are formed by the chemical interaction between the substance and the environment factors (Nilaya & Biswas, 2010). Cleaning of contamination of both loose and fixed types can be achieved by using a laser beam.

The strong and rapid absorption of laser beam energy leads to increase the temperature on the surface contaminant. The thermal expansion of the contaminant layer leads to a shock wave, resulting in ablation and vaporization of the material. The *Mechanical Interaction* the laser vaporization, followed by its dynamic expansion, generates the mechanical shock waves that propagate through the contaminant layer and breaks it down and causes the separation of particles of various sizes (Ion, 2005; Miotello & Ossi, 2010).

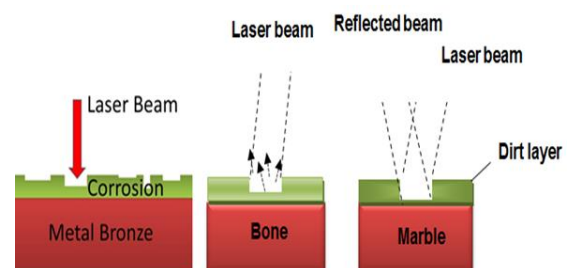

**Figure 3.** The description of the laser activity during cleaning in early time (absorption) and in late time (reflection).

#### Experimental Methods and Instrumentation

In this study, A modified Q-switched Nd:YAG laser, QSR (SINON, Quantel Derma GmbH, Germany), (Fig.) was applied for removing the unwanted layer and the foreign material from the surface of ancient objects. The instrument found in LASER

CARE CLINIC in Amman/Jordan, Q-switched ruby laser is used in the cosmetic dermatology field for removal of pigmentations and tattoos. Irradiation cleaning were carried out using the following YAG-laser system. The technical specifications of this system (table 2) are subjected to modify.

**Table 2.** Technical specifications of the device SINON YAG laser.

Wavelength	694 nm
Energy density	2-14 J/cm <sup>2</sup>
Pulse width	20 nsec
Beam diameter	3 / 4 / 5 / 6 mm
Repetition rate	0.5 - 2 Hz

A modified Q-switched Nd:YAG laser ((SINON, Quantel Derma GmbH, Germany)) with pulse duration in the range of 5-7 ns and maximum repetition rate of 2 Hz. The system emits both the fundamental wavelength (at 1064 nm) and its third harmonic (at 355 nm) at maximum energy outputs of 1000 mJ and 300 mJ, respectively.

## RESULTS AND DISCUSSION

### *Archaeological Materials under laser cleaning*

Some initial tests are done on numerous samples to determine the range of suitable parameters for safe and effective cleaning. As a result, the sample irradiated with influence of 5 J/cm<sup>2</sup>, frequency 2.5 Hz. As it is not possible to apply the laser radiation on museum artifacts, the study was performed on five archaeological samples (2 organic, 3 inorganic). The samples were taken from the store of Museum of Jordanian Heritage at Yarmouk University. The analyses were performed to determine the composition of contamination and corrosion layers. The sections of each sample were removed, using suitable tools in the labs of the faculty of Archaeology. In addition, the sections were repaired and examined with X-Ray Diffraction, and with X-Ray Fluorescent to determine the type of minerals or elements that help us to do the suitable wave length and the fitting cleaning procedure, the cleaned artifacts are shown in (table 3)

**Table 3.** shows the materials and the type of contamination reviewed for each object

object	Dirt Type
Bone	encrustation, calcareous layers
Manuscript (paper)	Iron Oxide ink stains
Glass	Black layer
Bronze	Atacamite, Malachite, Tenorite
marble	Iron rust stains

## BONE SAMPLE

The bone sample dating back to the Roman period from Umm Qais site (Avni, 2014; Stefano, Davis, & Corsane, 2014; Walker & Firestone, 2009), it was covered with hard gray-white encrustation and dust as shown in (Fig. 1). These deposits of insoluble salts consist mainly of calcium carbonate, quartz, and various kinds of sedimentary materials from the soil.



**Figure 4.** Deposits of dust and insoluble salts on the surface of bone sample, Region A is laser cleaned, the B region is not cleaned

The result of XRD analysis of this sample indicated that it contains calcite (CaCO<sub>3</sub>), hydroxylapatite Ca<sub>5</sub>(PO<sub>4</sub>)<sub>3</sub>(OH) and fluorapatite (Fig. 2).

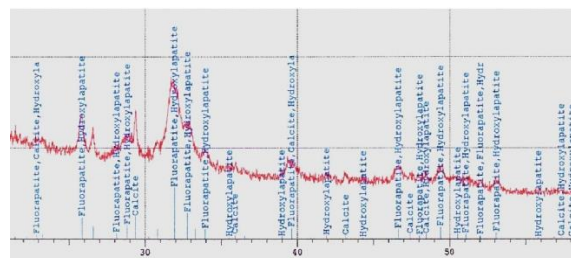

**Figure 5.** shows X-Ray powder diffraction results of bone sample.

Some initial tests were made on numerous samples to determine the range of suitable parameters for safe and effective cleaning. As a result, the sample irradiated with influence of 5 J/cm<sup>2</sup>, frequency 2.5 Hz. From thermal interaction, when surface encrustation absorbed laser irradiance, the thermal expansion leads to make the stain moves or vaporize the contamination.



**Figure 6.** Application of QSR irradiance on bone sample

### MANUSCRIPT (PAPER)

The manuscript was particularly in a good condition, the paper itself was glued onto a support, which was very badly preserved. According to visual investigation, it was immediately evident that several different inks were used. The composition of the black ink was of particular interest, and there are some characteristics in the paper sample which were covered with ink stain and adhesive (Fig. 7).

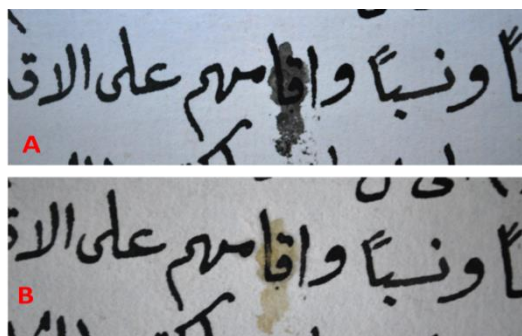

**Figure 7.** The ink stain on the manuscript, A: manuscript before cleaning, B: after cleaning with laser.

The manuscript sample was cleaned with the Q-switched ruby laser (Fig. 7). The sample irradiated with  $2 \text{ J/cm}^2$ , frequency 2.5 for 4 shots. Laser fluence levels must be stay below the ablation and destruction threshold of paper substrate, and have to exceed the threshold of the contaminant matter (Kautek, Pentzien, Rudolph, Krüger, & König, 1998).

### MARBLE SAMPLE

The marble sample was covered with iron rust stains as shown in (Fig. 8), the cleaned marble surface resulted in an effective removal of iron stain, these objects are the first in the Jordanian museums are treated by laser ablation methods (Sokhan et al., 2003).



**Figure 8.** Iron rust stain on surface of marble artifacts on the left side (A), and the cleaned right side (B).

From the result of XRF analysis of this sample indicated that it contains calcium as a main compound and iron as shown in (Fig. 9), these results need to know the composition of the dirt.

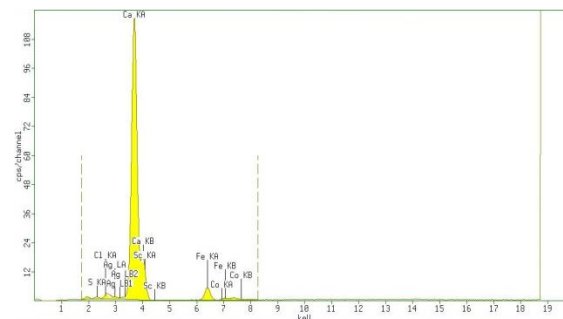

**Figure 9.** X-Ray fluorescence result of marble sample.

The marble sample was cleaned with the Q-switched ruby laser (Fig. 8). The sample irradiated with  $5 \text{ J/cm}^2$ , frequency 2.5. During work observed the darkening of stains color; when reddish-brown stains exposed to laser beam it was changed to gray color and in the second try all the stains totally removed and disappeared. The mechanism of reddish-brown stains darkening is not known but probably involves reduction of ferric oxide, the hematite ( $\text{Fe}_2\text{O}_3$ ) converted by local high temperature to ferrous oxide or wustite ( $\text{FeO}$ ). These analysis by Department of conservation of cultural resources at Yarmouk University in Jordan, it is clearly shows the advantage of YAG laser in cleaning of archaeological marble in Jordanian museums.

### BRONZE SAMPLE (BRACELET)

The bronze bracelet was found in the museum has a thick green corrosion covered by a layer of green corrosion products (Fig. 10) a thick green corrosion layer ( $\text{Cu}_2\text{NO}_3(\text{OH})_3$ ). These layers would seem to be due mainly to malachite  $\text{CuCO}_3 \cdot \text{Cu}(\text{OH})_2$  and contain chloride minerals such as atacamite  $\text{Cu}_2(\text{OH})_3\text{Cl}$  forming bright green layer.

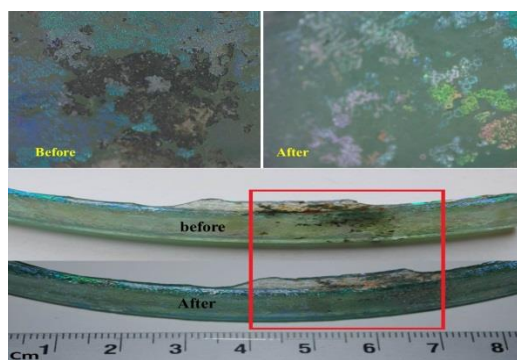

**Figure 10.** Green corrosion product covered the bracelet surface.

Two distinctive corrosion layers are observed on the bronze coupons: a thick green corrosion layer ( $\text{Cu}_2\text{NO}_3(\text{OH})_3$ ) that uniformly covers the entire surface and under this a dark oxide layer ( $\text{CuO}$ ). Considering that this dark oxide layer acts as a barrier that protects the underlying metal surface from further corrosion (Cronyn, 2003) it was decided to remove only the green corrosion layer while keeping the oxide layer intact.

#### GLASS SAMPLE

The results of the glass sample which was cleaned with  $4 \text{ J/cm}^2$  for 10 shots showed that Q-switched the ruby laser beams could remove the entire unwanted layer which covered the surface of glass sample without any effects on irradiance and without any damage of the original surface (Fig. 11) no stained remained and crack observed after laser cleaning.



**Figure 11.** Glass artifacts before and after YAG laser cleaning

From the above-shown preliminary results, focused on the study of red wavelengths (694 nm) in the ns regime, it is clear that many issues still have to be answered. Red radiation at 694 nm with ns pulse duration emitted from a Q-switched Nd:YAG laser

#### ACKNOWLEDGMENT

The authors gratefully acknowledge Dr. Waddah Yousef Barghouti the director of Alma Clinic who allowed us to use his Nd:YAG lasers system for the experiments.

was found to be able to remove archaeologically grown corrosion on copper and relatively thin corrosion products from bronze and thin layers of calcareous patina on bone and stain spots on marble and glass, with quite satisfactory results. Still their application in ancient objects with thicker, harder, and more inhomogeneous corrosion layers should be in the Jordanian museums considered. This approach in cultural heritage field is found to be able to remove many types of corrosion or contamination from most types of artifacts good enough to meet the requirement of the cleaning in conservation of cultural heritage field. The laser cleaning is performed with arrangement systems with harder laser or shorter pulse widths is very satisfactory. The exhaustive and comparative evaluation of these applications may answer many of the unsolved issues in artifacts conservation and will specify the suitable laser parameters for the cleaning of each distinct artifacts.

The studies are focused as shown in this work on the use of red laser (694 nm) of pulse width twenty nanoseconds (ns). Through many experiments damage and removal threshold values are determined for the different artifacts corrosion layers, respectively. The irradiated surfaces are evaluated microscopically under the optical microscope in the lab of the department, while the chemical compositions of the layers were determined with X-ray diffraction analyses. The obtained results are giving an approach for understanding the mechanisms that are significant in the different laser cleaning methods, the precision of focused laser beam cleans exactly the layer by layer on the archaeological objects.

We have used in this study to be the first in Jordan that use laser technique in order to use localized carefully treatment of patina, containing organic fibres, mineral particles, stain, dirt, etc. in conservation of archaeological materials in Jordan.

The main problem the cleaning by traditional methods in the conservation of the archaeological materials as bone, glass, and metals was connected with the selection of the suitable technique for removing the dark stain or layer, most of traditional methods need to use organic solvents or acids that harm the object, but the laser is used without organic solvent and localized to remove the contamination.

## REFERENCES

- Ahmad Shazwi, Kamaruzaman. (2008). *Carbon Dioxide (CO<sub>2</sub>) laser cut quality of acrylic*. University of Malaysia Pahang.
- Atom, Laser And Spectroscopy*. Prentice-Hall Of India Pvt. Limited.
- Avni, G. (2014). *The Byzantine-Islamic Transition in Palestine: An Archaeological Approach*: OUP Oxford.
- Bloisi, F, Barone, AC, & Vicari, L. (2004). Dry laser cleaning of mechanically thin films. *Applied surface science*, 238(1), 121-124.
- Bloisi, Francesco, di Blasio, Giuseppina, Vicari, Luciano, & Zoncheddu, Monica. (2006). Laser cleaning for cultural heritage. *New Topics in Lasers and Electro-Optics*, Nova Science Publishers Inc., New York, 115-151.
- Cooper, Martin. (1997). *Laser cleaning in conservation: an introduction*: Butterworth-Heinemann.
- Cooper, Martin I, Emmony, David C, & Larson, John H. (1992). *A comparative study of the laser cleaning of limestone*. Paper presented at the Proceedings of the 7th International Congress on Deterioration and Conservation of Stone: held in Lisbon, Portugal, 15-18 June 1992.
- Cooper, MI, Emmony, DC, & Larson, J. (1995). Characterization of laser cleaning of limestone. *Optics & Laser Technology*, 27(1), 69-73.
- Cronyn, Janet Margaret. (2003). *Elements of archaeological conservation*: Routledge.
- Csele, M. (2011). *Fundamentals of Light Sources and Lasers*: Wiley.
- Encyclopaedia Britannica, inc. (1986). *Yearbook of Science and the Future*: Encyclopaedia Britannica.
- Engineering Physics*. (2010). McGraw-Hill Education (India) Pvt Limited.
- Fekrsanati, Farideh, Klein, Stefan, Hildenhagen, Jens, Dickmann, Klaus, Marakis, Yiorgos, Manousaki, Aleka, & Zafiropulos, Vassilis. (2001). Investigations regarding the behaviour of historic glass and its surface layers towards different wavelengths applied for laser cleaning. *Journal of Cultural Heritage*, 2(4), 253-258.
- Ghatak, A. (2009). *Optics*: McGraw-Hill Education.
- Introduction To Solid State Physics*, 1/e. Prentice-Hall Of India Pvt Limited.
- Ion, John. (2005). *Laser processing of engineering materials: principles, procedure and industrial application*: Butterworth-Heinemann.
- Kautek, Wolfgang, Pentzien, Simone, Rudolph, Pascale, Krüger, Jörg, & König, Eberhard. (1998). Laser interaction with coated collagen and cellulose fibre composites: fundamentals of laser cleaning of ancient parchment manuscripts and paper. *Applied surface science*, 127, 746-754.
- Khare, P., & Swarup, A. (2009). *Engineering Physics: Fundamentals & Modern Applications*: Jones and Bartlett Publishers.
- Klein, S, Fekrsanati, F, Hildenhagen, J, Dickmann, K, Uphoff, H, Marakis, Y, & Zafiropulos, V. (2001). Discoloration of marble during laser cleaning by Nd: YAG laser wavelengths. *Applied Surface Science*, 171(3), 242-251.
- Klein, Stefan, Hildenhagen, Jens, Dickmann, Klaus, Stratoudaki, T, & Zafiropulos, Vassilis. (2000). LIBS-spectroscopy for monitoring and control of the laser cleaning process of stone and medieval glass. *Journal of Cultural Heritage*, 1, S287-S292.
- Kobayashi, Kojiro F. (1999). Laser processing. *Pergamon Materials Series*, 2, 89-118.
- Koss, A, Drescik, D, Marczak, J, Ostrowski, R, Rycyk, A, & Strzelec, M. (2008). *Laser cleaning of a set of 18th century ivory statues of Twelve Apostles*. Paper presented at the Lasers in the Conservation of Artworks: Proceedings of the International Conference Lacona VII, Madrid, Spain, 17-21 September 2007.
- Landucci, Francesco, Pini, Roberto, Siano, Salvatore, Salimbeni, Renzo, & Pecchioni, Elena. (2000). Laser cleaning of fossil vertebrates: a preliminary report. *Journal of Cultural Heritage*, 1, S263-S267.
- Lukishova, Svetlana G, Bissell, Luke J, Winkler, Justin, & Stroud, CR. (2012). Resonance in quantum dot fluorescence in a photonic bandgap liquid crystal host. *Optics letters*, 37(7), 1259-1261.
- Meyer, HJ. (1964). Die Produkte der atmosphärischen Korrosion einiger Gebrauchsmetalle. *Materials and Corrosion*, 15(8), 653-660.
- Miotello, Antonio, & Ossi, Paolo M. (2010). *Laser-surface interactions for new materials production*: Springer.
- Mottner, P, Wiedemann, G, Haber, G, Conrad, W, & Gervais, A. (2005). Laser cleaning of metal surface – laboratory investigations *Lasers in the Conservation of Artworks* (pp. 79-86): Springer.
- Nambiar, KR. (2006). *Lasers: Principles, Types and Applications*: New Age International.

- Nilaya, J Padma, & Biswas, Dhruva J. (2010). Laser assisted decontamination of metal surface: Evidence of increased surface absorptivity due to field enhancement caused by transparent/semi-transparent contaminant particulates. *Applied Surface Science*, 256(6), 1867-1870.
- Oakes, Elizabeth H. (2007). *Encyclopedia of world scientists*: Infobase Publishing.
- Ready, John F. (1997). *Industrial applications of lasers*: Academic press.
- Schikorr, Gerhard. (1963). Über den Mechanismus des atmosphärischen Rostens des Eisens. *Materials and Corrosion*, 14(2), 69-80.
- Sokhan, Marina, Gaspar, Pedro, McPhail, David S, Cummings, Alan, Cornish, Larrain, Pullen, Derek, . . . Merkel, John F. (2003). Initial results on laser cleaning at the Victoria & Albert Museum, Natural History Museum and Tate Gallery. *Journal of Cultural Heritage*, 4, 230-236.
- Stefano, M.L., Davis, P., & Corsane, G. (2014). *Safeguarding Intangible Cultural Heritage*: Boydell & Brewer Incorporated.
- Stöckle, Bruno, Fitz, Stöckle, Mach, Martin, Pöhlmann, Georg, & Snethlage, Rolf. (1993). Die atmosphärische Korrosion von Kupfer und Bronze im Rahmen des UN/ECE-Expositionsprogramms. Zwischenbericht nach 4-jähriger Bewitterung. *Materials and Corrosion*, 44(2), 48-56.
- Stöckle, Bruno, & Krätschmer, Andreas. (1998). Die atmosphärische Korrosion von Kupfer und Bronze: Ergebnisse aus dem UN/ECE-Bewitterungsprogramm *Metallrestaurierung: Internationale Tagung zur Metallrestaurierung veranstaltet vom Bayerischen Landesamt für Denkmalpflege und vom Deutschen Nationalkomitee von ICOMOS, München, 23.-25. Oktober 1997* (pp. 26-32): Bayerisches Landesamt für Denkmalpflege.
- Strandberg, H, Johansson, L-G, & Lindqvist, O. (1997). The Atmospheric corrosion of statue bronzes exposed to SO<sub>2</sub> and NO<sub>2</sub>. *Materials and Corrosion*, 48(11), 721-730.
- Subrahmanyam, N., Lal, B., & Avadhanulu, N. (2004). *A Text Book of Optics (m.e.)*: S. Chand Limited.
- Tam, Andrew C, Leung, Wing P, Zapka, Werner, & Ziemlich, Winfrid. (1992). Laser-cleaning techniques for removal of surface particulates. *Journal of Applied Physics*, 71(7), 3515-3523.
- Thyagarajan, K, & Ghatak, Ajoy. (2010). *Lasers: fundamentals and applications*: Springer Science & Business Media.
- Walker, J., & Firestone, M.D. (2009). *Jordan: Lonely Planet*.
- Wiederholt, W. (1964). Die atmosphärische Korrosion von Kupfer und Kupferlegierungen. *Materials and Corrosion*, 15(8), 633-644.
- Wiersma, Diederik S, & Lagendijk, Ad. (1996). Light diffusion with gain and random lasers. *Physical Review E*, 54(4), 4256.