

The Conundrum of Specifying very low Wave Overtopping Discharges

Eunice Silva, Coastal Structures Group, HR Wallingford, United Kingdom
William Allsop, Coastal Structures Group, HR Wallingford, United Kingdom
Roberta Riva, Ships Group, HR Wallingford, United Kingdom
Paulo Rosa Santos, Faculdade de Engenharia da Universidade do Porto (FEUP), Portugal
Francisco Taveira Pinto, Faculdade de Engenharia da Universidade do Porto (FEUP), Portugal
Ana Mendonça, Laboratório Nacional de Engenharia Civil (LNEC), Portugal
Maria Teresa Reis, Laboratório Nacional de Engenharia Civil (LNEC), Portugal

Abstract

The design of certain seawalls / breakwaters has often been required to achieve very low target overtopping discharges when these structures protect vulnerable infrastructure or activities. The balance between economically viable protection and performance requirements is often difficult to achieve without good knowledge on low overtopping. The paucity of data in this space and the high uncertainties associated with existing methods, increase the challenge. The occurrence of a low number of overtopping waves has the consequence that any test results are substantially more affected by the inherent variation of random waves, therefore more uncertain. The physical model test results presented hereafter were successful in obtaining low to very low overtopping discharge data. For low / very low overtopping, these test data present considerable scatter relative to the latest empirical prediction. A number of repetitions was performed for conditions giving very low overtopping discharges, which illustrated the inherent uncertainty associated with low overtopping.

Introduction

Background

In designing vulnerable coastal infrastructure, particularly oil / gas processing plants, power stations or similar, owners / designers often need to specify very low target overtopping discharges, even under quite long return period conditions. The simplest way (but most expensive) to achieve this low-overtopping performance may simply be to design the seawalls / breakwaters to be higher. But for industrial processes involving (for instance) LNG, the possibility of trapping escaped gas behind such raised defence structures gives rise to other hazards. Urban communities also value strongly sea views from their promenades. So designers have very strong motivations to keep defence crests low. In all instances, good understanding of overtopping performance is of paramount importance.

In early guidance on 'tolerable' overtopping discharges, Owen (1980) summarised overtopping limits based primarily on mean discharges. Besley (1999) tried to include peak volumes as well as mean discharges, but this change was hampered by the paucity of data on wave-by-wave volumes. Guidance in the first EurOtop Manual (2007) tried to balance both mean discharges and peak volumes. Suggestions in the EurOtop 2 Manual (EurOtop, 2016) extend this by qualifying mean discharge limits by the wave heights used to determine them.

Various options are available to achieve these objectives, but all require significant and robust information on the occurrence of low overtopping. This is however made substantially more difficult by greater uncertainties associated with low discharges where existing prediction methods become increasingly less certain. Part of the problem is illustrated in Figure 1 where four overtopping cases

are compared, all for a 1:2 smooth impermeable slope using the EurOtop 2 formulae for a notional duration of 1000 waves. In the four cases in Figure 1, the crest levels have been set to give the same mean overtopping discharge of 0.6 l/s/m, for four different significant wave heights of $H_s = 2$ to 5 m. The four crest levels are different, but they deliver the same mean overtopping discharge in rather different ways. For the smallest wave height, the crest level is low, and many (small) waves give many (small) overtopping volumes. But for the highest crest and the largest wave heights, only a few overtopping events (each of relatively large volume), are sufficient to give the same mean overtopping discharge.

The four curves in Figure 1 show how the same mean discharge can be given by four rather different situations. For the lower right curve around 15 overtopping events (from 1000 waves) give the total overtopping volume, and hence mean discharge. For the upper left curve, only 4 overtopping events (still from 1000 waves) give the total overtopping. If one were to reduce the target overtopping limit further, say to $q \leq 0.1$ l/s/m, then the number of overtopping waves will reduce to smaller than 0.4%. For these extremely low number of overtopping waves, the inherent variations of random waves and of the overtopping processes mean that the results of any individual test become substantially more variable, and hence more uncertain.

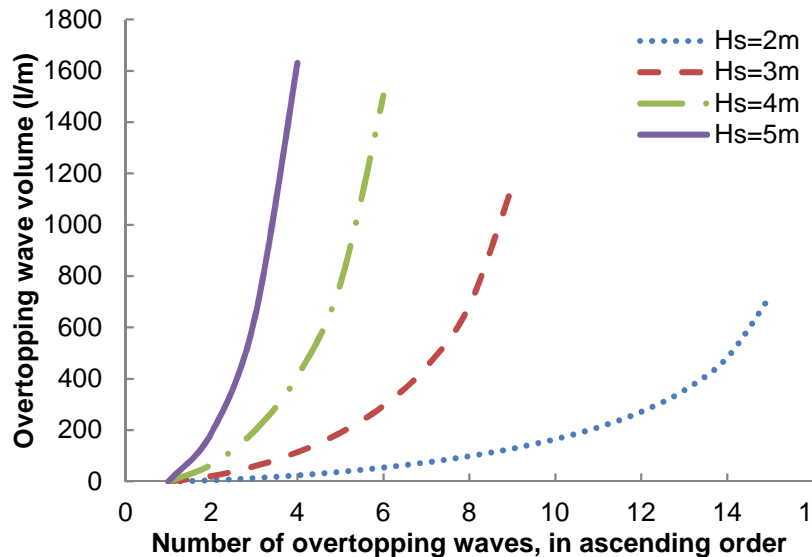

Figure 1 Overtopping volumes for $q=0.6$ l/s/m, four different crest levels and wave conditions

Previous tests by Reis et al. (2008) and Romano et al. (2015) suggest that for rubble mound breakwaters mean overtopping discharges can generally give a stable prediction from tests of only 500 waves. Reis et al. (2008) however remind us that information from only a single test gives limited information, as mean discharges will vary even for the same wave and structure characteristics. Better information on mean discharge may be given by several short duration tests with different time series rather from a single long sample. Romano et al. (2015) noted that their low discharge data show wider variability, with the mean rate of overtopping in time varying significantly within the sequence. It is clear that this needs further test data at very low overtopping discharges. In designing such tests, a smooth (rather than armoured) slope will give more sensitive responses to hydraulic inputs, and a 1:2 slope greater overtopping than other slopes (EurOtop, 2016).

Outline of the paper

This paper presents the results of physical model tests at HR Wallingford and compares results with selected results from other laboratories (LNEC and FEUP) under a joint research programme. A description of the overtopping tests is given, including the study design and procedure for wave calibrations. Test results for mean overtopping discharges and individual volumes are plotted and described. Test results from other laboratories within the same task of the joint research programme are then added. These results are then discussed and conclusions are drawn.

HYDRALAB+ RECIPE research studies

Within the multi-institute cooperation project HYDRALAB+ (EC Contract No. 654110), the Joint Research Action RECIPE is intended to ensure that physical hydraulic modelling plays its full role in solving problems of climate change mitigation and adaptation. The main objective of Task 8.2 is to develop protocols for experiments in physical models representative of extreme events (storms, floods, etc.) or sequence of such events, since these events and their frequency are strongly impacted by climate change.

Under HYDRALAB+ RECIPE Task8.2 coordinated model tests of idealised coastal structures compared various armour and overtopping responses. In this paper measurements at laboratories at Lisbon, Porto and Wallingford are compared. The tests at Wallingford measured overtopping volumes, wave-by-wave, and mean discharge for a simple impermeable smooth 1:2 slope at a nominal scale of 1:20. The test conditions were carefully designed to cover a wide range of overtopping, but particularly under low-discharge conditions, illustrated by the simulations in Figure 1. Some of these measurements were replicated at Lisbon (LNEC), and Porto (FEUP). Tests at LNEC used a smaller model scale (reduction of about 2x), including two sets of 10 repetitions (different time series) of some test conditions, for durations of 1000 and 500 waves. The laboratories also ran extended tests and/or multiple 500 or 1000 wave samples to extend the work by Romano et al (2015) to lower discharges. Tests at FEUP were carried out on a geometrical scale of 1/35 with a 3D physical model (trunk and roundhead of a rubble-mound breakwater).

HR Wallingford overtopping tests

The 2D model tests at HR Wallingford measured wave overtopping on a simple (smooth) 1:2 slope at a nominal scale of 1:20 with two different crest levels equivalent to 20m above bed level (structure A1) and 24m (structure A2). The tests were carried out in one of HR Wallingford's wave flumes, which is 50m long, 1m deep and 1m wide. No approach slope or bathymetry was used, so depths at the structure toe were the same as at the wave paddle (refer to Figure 2). The relatively deep water was chosen to remove / reduce any shallow water influences on wave conditions with any consequential distortions to overtopping results, and to simplify the test section. Collection chutes from the test section to the measurement tanks varied between 0.8m to 6.7m (in prototype) width to accommodate a wide range of discharges with three tank sizes.

Most tests were run at water levels of 14m and 15m, (respectively 19 and 35 tests), and nine tests using a water level of 16m, all levels referred to sea bed. The target wave conditions were $H_s \approx 0.8$ to 3.7m, and also allowing for extreme testing to $H_s \approx 4.8$ m. The mean wave periods (T_m) ranged from 5s to 13s. The suggested conditions gave wave steepnesses of $s_{0m} \sim 0.06$ (storm sea), 0.035 (ocean waves), and 0.01 (swell) for deep water. Tests were run for 500 or 1000 waves, although one test used multiple simulations with changed seed (starting point in an infinite long sequence) to give 10 x 1000 wave samples. This is particularly important for very low discharges. The sequence of the test conditions is not significant since there is no cumulative effect in overtopping. The order of tests was therefore defined according to convenience.

Mean overtopping discharges, q , measured during testing were compared with predictions given by the empirical formulae from the EurOtop 2 Manual (EurOtop, 2016). The number of overtopping waves, N_{ow} , and the individual overtopping volumes, V_{ow} , were also determined.



Figure 2 Flume layout with 1:2 slope (after calibration) showing wave paddle, five wave gauges, test section and absorbing beach.

Test design

The tests were intended to generate overtopping data leading to the development of guidance (eventually) to simplify and accelerate model testing for analysis of wave overtopping-critical coastal structures. The first step for the design of the tests was the definition of possible wave heights, wave periods and respective steepnesses, all of which must fit the wave maker capacity (viable tests). The second step required calculations of mean overtopping discharges for all suggested wave conditions with the empirical formulae from the EurOtop 2 Manual (EurOtop, 2016). Alternative formulae or online tools were used for verification i.e. PC OVERTOPPING, EurOtop (2007). These results suggested interesting (mainly low / very low discharges or volumes) test conditions. The third step taken was to estimate the number of overtopping waves and the individual maximum overtopping volumes expected. These were the basis for identifying test durations and where it could be useful to use multiple simulations changing the seed.

Wave calibrations

Test conditions were calibrated in the flume before construction of the test section, to minimise corruption of incident waves by reflections. Calibration was an iterative process. The amplitude of the signal driving the wave generator was adjusted until the spectral significant wave height measured at the calibration point was within $\pm 5\%$ of the target significant wave height. The waves were non-repeating wave sequences, with durations equal to $1,000T_m$, of the target spectrum, required for a statistically significant sample for wave calibration analysis. The calibrated wave conditions are presented in Table 1 (with an extra condition that was tested).

Table 1 Calibrated wave conditions

Incident wave condition	SWL (m)	H_{m0} (m)	s_m (-)	T_m (s)	T_p (s)
WC01	16	1.6	0.036	5.32	5.90
WC02	16	2.2	0.036	6.26	6.89
WC03	16	0.8	0.010	7.16	7.87
WC04	16	1.2	0.010	8.77	10.3
WC05	15	2.8	0.062	5.37	5.90
WC05J02	15	2.8	0.062	5.37	5.90
WC05J12	15	2.8	0.062	5.37	5.90
WC05J01	15	2.8	0.062	5.37	5.90
WC05J06	15	2.8	0.062	5.37	5.90
WC06	15	1.6	0.036	5.32	5.90
WC07	15	3.7	0.060	6.31	6.89
WC08	15	2.2	0.036	6.26	6.89
WC09	15	4.8	0.060	7.16	7.87
WC10	15	2.8	0.035	7.16	7.87
WC10J12	15	2.8	0.035	7.16	7.87
WC10J01	15	2.8	0.035	7.16	7.87
WC10J06	15	2.8	0.035	7.16	7.87
WC11	15	0.8	0.010	7.16	7.87
WC12	15	3.0	0.035	7.42	10.3
WC13	15	1.4	0.010	9.48	10.3
WC14	15	2.8	0.010	13.37	14.8
WC15	14	2.8	0.062	5.37	5.90
WC16	14	1.6	0.036	5.32	5.90
WC17	14	3.7	0.060	6.31	6.89
WC18	14	2.2	0.036	6.26	6.89
WC19	14	0.8	0.010	7.16	7.87
WC20	14	2.8	0.060	5.46	7.87
WC21	14	4.8	0.036	9.26	7.87
WC22	14	4.0	0.036	8.45	10.3
WC23	14	1.4	0.010	9.48	10.3
WC24	14	2.8	0.010	13.37	14.8
WC25 (added later)	14	2.2	0.015	9.62	10.3

Test results

Mean discharge

The overall test results for the 1:2 smooth slope obtained are shown in Figure 3 where dimensionless discharge ($q^* = q / (gH_{m0}^3)^{0.5}$) is plotted against dimensionless freeboard (R_o / H_{m0}). The data are grouped by steepness for analysis. The data are plotted together with the EurOtop 2 predictions, (equation 5.18) and upper and lower 5% confidence bands. Data obtained below $q^* = 10^{-8}$ are considered to be equivalent to 'no overtopping', since the measuring instruments are unable to detect variations smaller than this limit. It is noticed that all of the very low overtopping data points are associated to low steepness wave conditions, $s_{0m} < 0.03$.

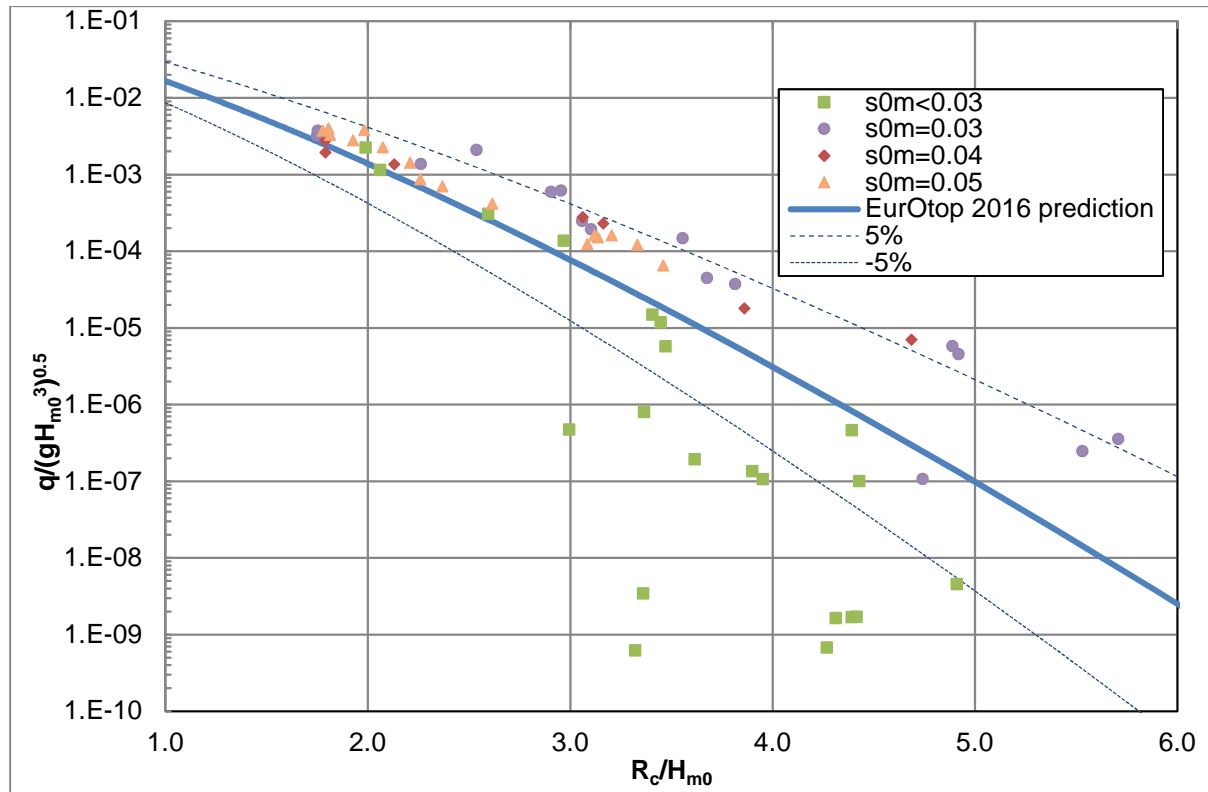

Figure 3 Wave overtopping data compared with EurOtop 2 (eq. 5.18)

After running the main test conditions, various repetitions were performed for those wave conditions resulting in very low overtopping discharges. Some repetitions were carried out with a different duration and others with a different seed. All data points in Figure 4 labelled with *_a* correspond to a repetition of the original wave condition, labelled with *_b* represent a repetition with different seed, and with *_c* refer to a repetition with the new seed and a different number of waves (1000 or 10,000). Exception to this is WC14_a that was a repetition of WC14 with a duration of 1000 waves instead of the original 500. The overtopping results from these repetitions illustrate inherent uncertainties associated with very low overtopping discharges. Taking as example WC13, WC13_a and WC13_b (refer to Figure 4), the original wave condition (WC13) and its exact repetition (WC13_a) result in no overtopping, but when starting at a different position in the 'parent' sequence (using a different seed) the measured overtopping was at least three orders of magnitude larger. The same type of observation is valid for WC23 and WC14 although the difference is about one order of magnitude.

A long duration test was performed for WC23 (10,000 waves). Firstly one sample of long duration was analysed and then 10 shorter samples of 1000 waves. Data point WC23_c represents one sample of long duration while in Figure 5 the 10 samples of 1000 waves are individually presented. For WC14_a and WC14_b likewise one sample of 1000 waves and then two shorter samples of 500 waves were analysed (refer to Figure 5). These results are generally in line with the conclusion from Romano et al. (2015) that shorter time series (500 waves) can be used for most overtopping tests, but the rate of overtopping can vary greatly within the sequence. The danger is however illustrated in the one sample in WC23 which is 10 – 100 times greater than the other samples.

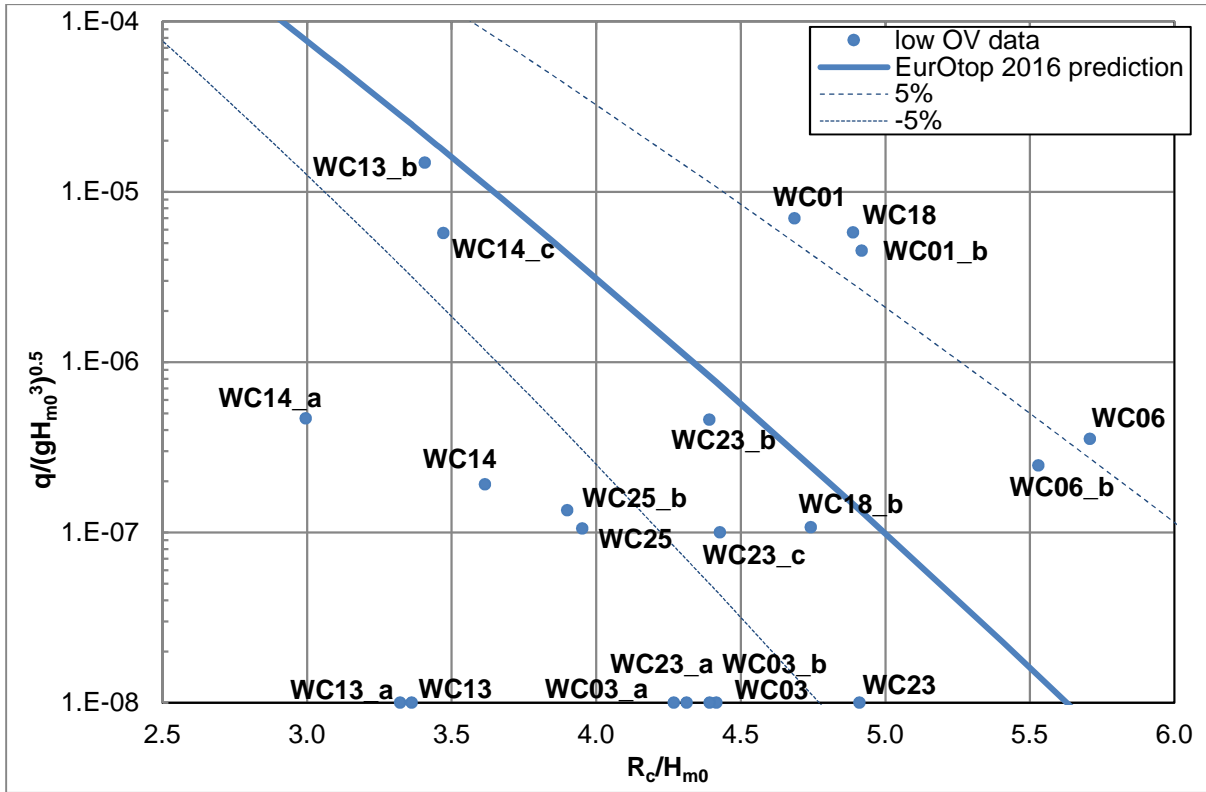

Figure 4 Wave overtopping data, repeated wave conditions (note zoomed-in axes)

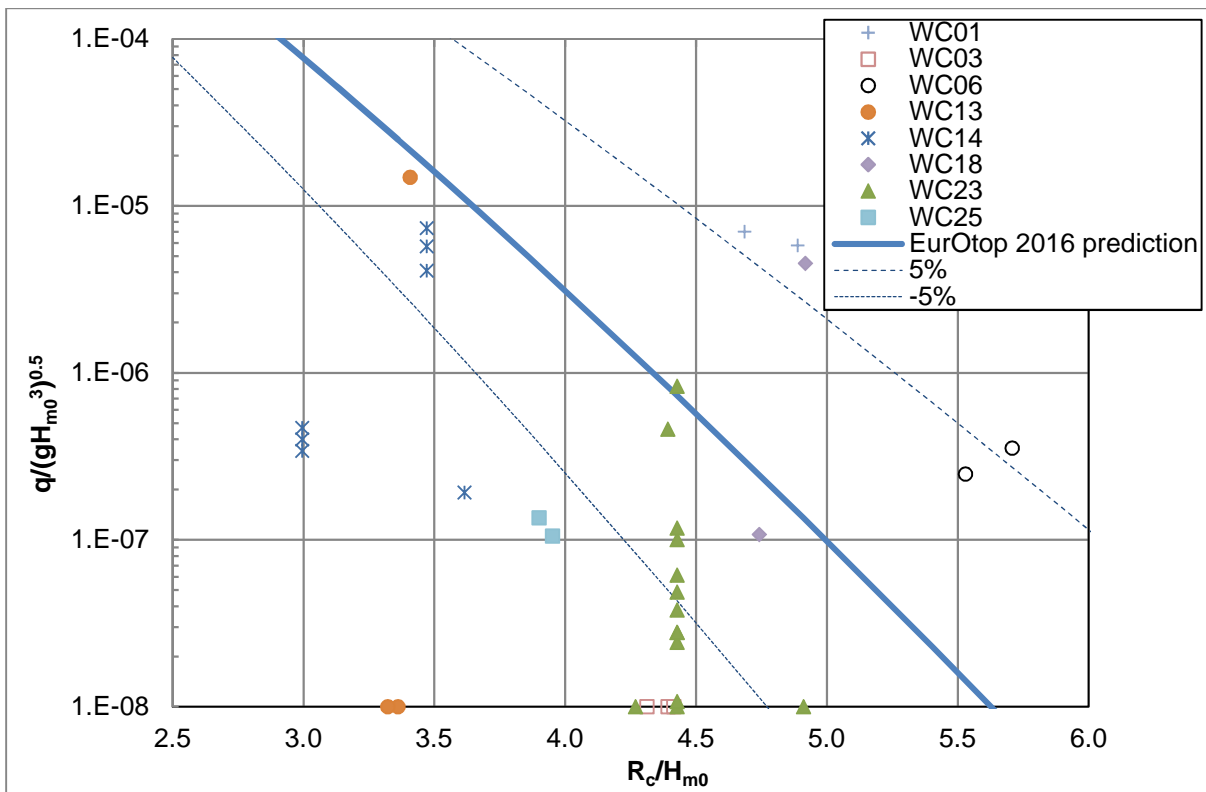

Figure 5 Wave overtopping data – expanded (repeated wave conditions)

Individual volumes

Most waves do NOT lead to overtopping. Even for the largest overtopping discharges modelled here, generally fewer than 25% waves gave overtopping. Indeed, a few tests gave less than 0.5% - we were specifically trying to test such conditions. So it is clear that in any given test the total overtopping volume arrived from only a small proportion of the waves generated. Figure 6 illustrates the progress of overtopping during a moderate overtopping test ($H_{m0}=2.3\text{m}$ $T_{m-1,0}=6.39\text{s}$ $R_c=9\text{m}$).

But, it may be of interest to assess what proportion of that water was carried by any particular (overtopping) wave, or perhaps more usefully, what is the largest proportion? Figure 7 illustrates the distribution of individual volumes as a proportion of the average volume (in the overtopping waves). The probability of non-exceedance (P_{ow}) of each individual volume in the test is plotted against a non-dimensional volume

(V_i/V_{average}). As expected, most overtopping events (by number) fall below $V_i/V_{\text{average}} = 1$. Only a few fall above $V_i/V_{\text{average}} = 3$, and in these tests, none fell above $V_i/V_{\text{average}} = 6$. So whilst EurOtop 2 gives a method to calculate V_{max} , a rapid estimate of the upper limit might simply use the number of overtopping waves, N_{ow} , the mean discharge q , and V_i/V_{average} to give V_{max} .

FEUP tests

The experiments at FEUP were designed to obtain data on armour damage progression on rubble-mound structures and to study overtopping, discussed here. The tests were carried out in a wave basin (28m long, 12m wide and 1.2m deep), equipped with a 12m wide multi-element wave maker. A rubble-mound breakwater (refer to Figure 8) was modelled in the wave basin at a 1:35 geometrical scale. The trunk was built perpendicular to the basin sidewall and a semi-circular roundhead ended the structure. The breakwater model was 5.6 m long, 3.1 m wide and 0.68 m high. The rock armour on the front and back slopes (1:2) was placed in a double layer. Two water depths were tested: 19.8m and 20.6m, relative to the basin floor. The tests were carried out with irregular waves, either long or short crested (short crested wave results are not analysed here). Each test consisted of about 1000

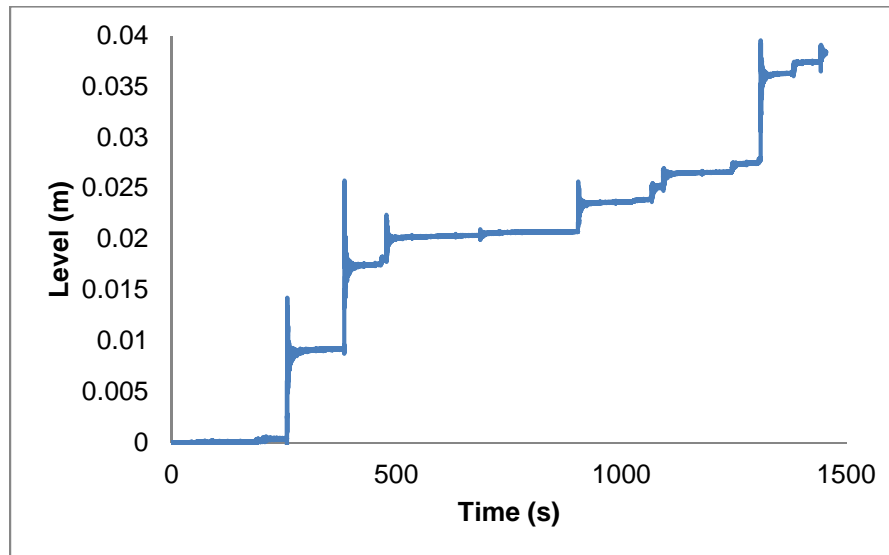

Figure 6 Example of overtopping tank time series (model)

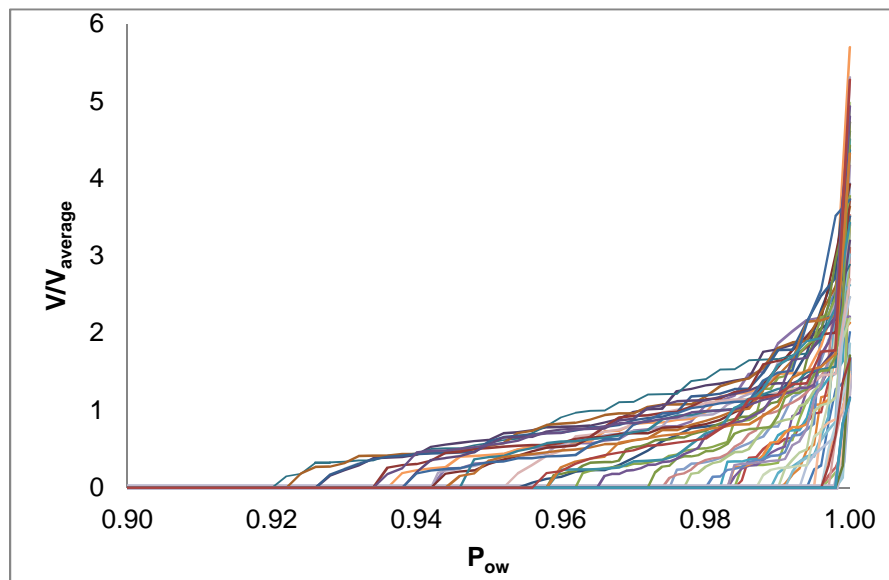

Figure 7 Dimensionless individual overtopping volumes against the probability of non-exceedance

waves. Incident significant wave heights (H_{m0}) of 2.7, 3.6, 4.3 and 5.3m, and peak wave periods (T_p) of 7.6, 9.3, 11.1 and 12.9s were tested, at a constant local wave steepness $s_p = 0.03$.

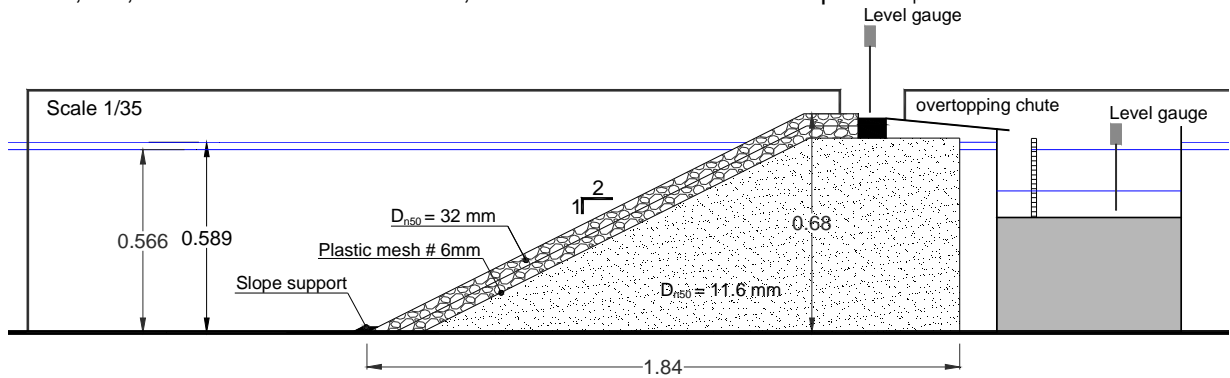

Figure 8 FEUP test cross-section (model units)

LNEC tests

The experiments at LNEC were designed primarily to obtain data on armour damage progression on rubble-mound structures. Overtopping, discussed here, was of secondary interest. The tests were carried out in a wave flume (50m long, 0.8m wide, and 0.8m deep). The breakwater was built to a Froude scale of 1:30 (refer to Figure 9). The armour with a slope of 1:2 had two layers of rock with porosity $\sim 40\%$. A foreshore with a slope of $\sim 2.3\%$ was used. Two water depths (at the toe of the structure) were tested: 8.1m and 11.1m. Significant wave heights, H_s , up to 6.2m, and peak wave periods, T_p 10 – 12 s were tested. Test duration was defined to have at least 1000 waves.

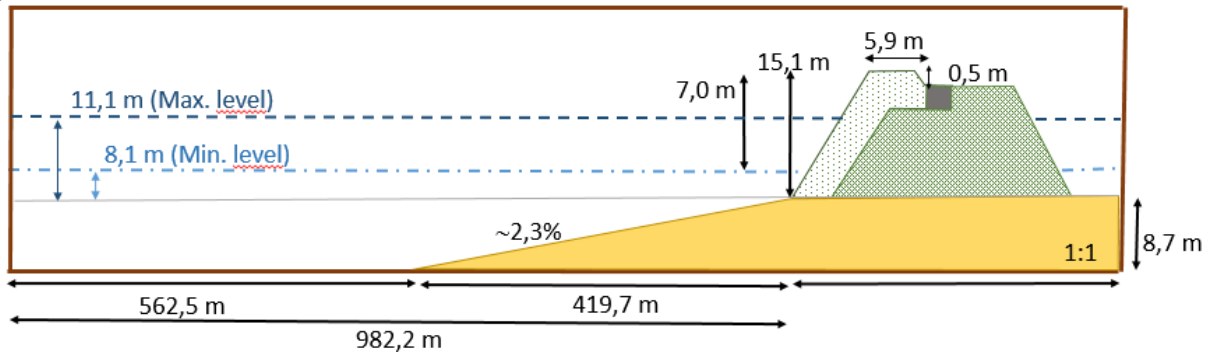

Figure 9 LNEC test setup (prototype)

Data comparison

Regarding the FEUP tests, Figure 10 compares the experimental q^* as a function of R_c/H_{m0} , with equation 6.5 from the EurOtop 2 Manual, with roughness $\gamma_f=0.45$ and $\beta=0^\circ$. Upper and lower 5% confidence bands are indicated. The agreement between the experimental results and the EurOtop 2 predictions is, in general, good. Individual overtopping volumes were analysed for each test condition (except for the 2 tests where the overtopping tank was full after

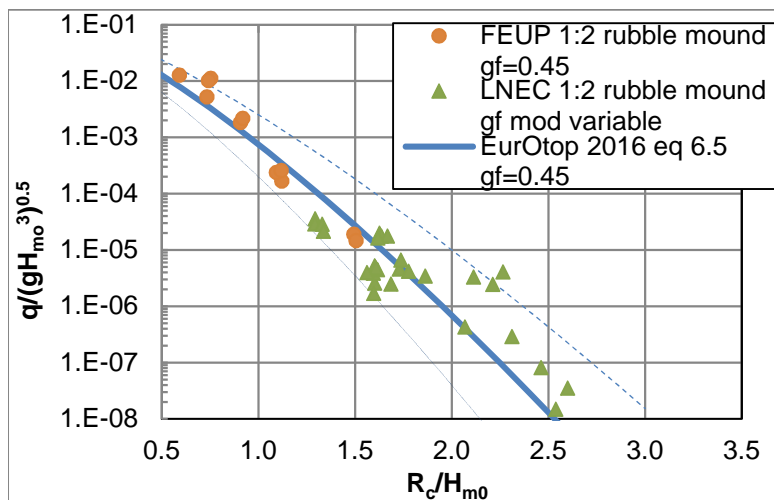

Figure 10 Wave overtopping on armoured slopes from FEUP and LNEC

~100 waves), when plotting dimensionless volume against the probability of non-exceedance (Figure 11) the maximum individual volume is not larger than approximately 6.5 times the average of the test volumes.

The results of q^* against R_c/H_{m0} from LNEC tests were also plotted in Figure 10. A direct comparison with the empirical prediction using a nominal $\gamma_f=0.45$ appears to be an acceptable simplification. For these tests, the EurOtop 2 Manual prediction method should use the modified roughness factor according to equation 6.7, which will vary between $\gamma_f=0.4$ and 0.6. The agreement between the experimental results and the EurOtop 2 predictions is good. Individual overtopping volumes were analysed for each test condition, when plotting dimensionless volume against the probability of non-exceedance (Figure 11) the maximum individual volume is not larger than approximately 9.5 times the average of the test volumes.

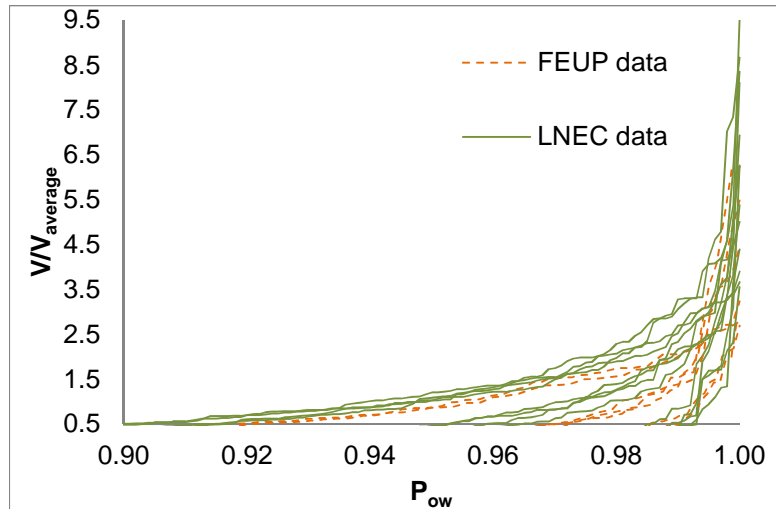

Figure 11 Dimensionless individual overtopping volumes against the probability of non-exceedance

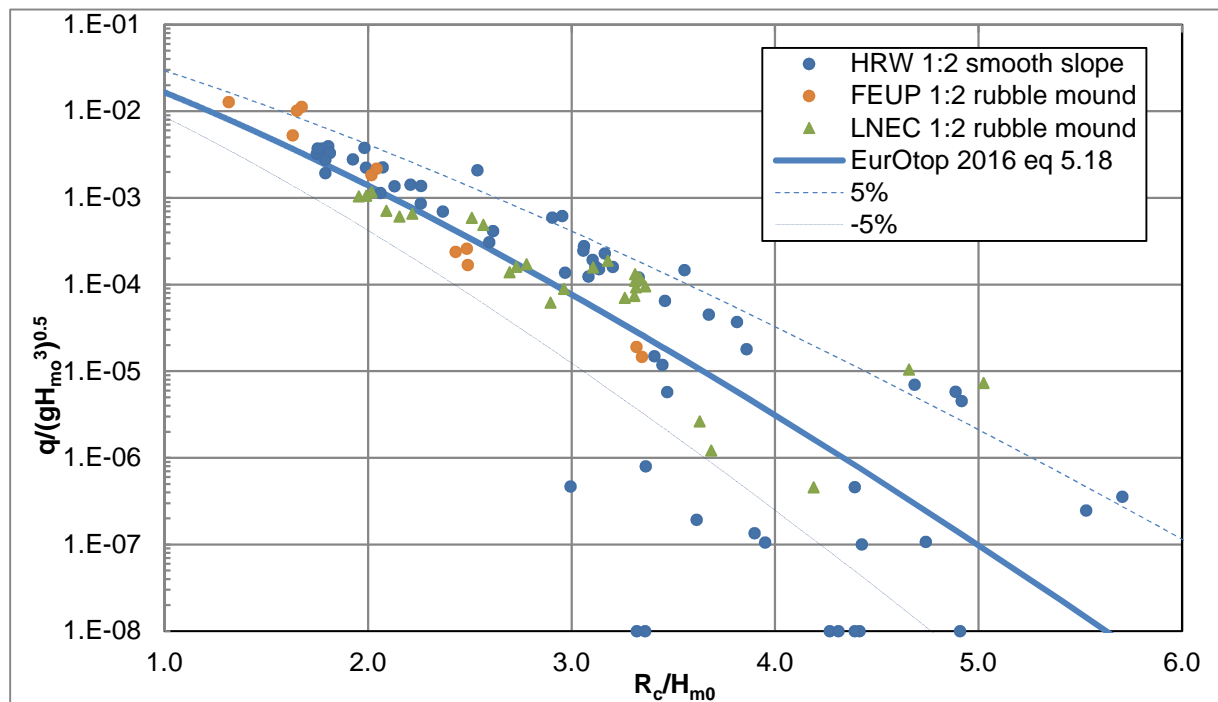

Figure 12 Wave overtopping data from HR Wallingford, FEUP and LNEC harmonized (R_c scaled by γ_f)

The overtopping test results obtained at the three laboratories (HR Wallingford, FEUP and LNEC) were compared in Figure 12. In order to compare overtopping for a smooth slope and the rough slopes, the dimensionless freeboard was scaled as if for a smooth slope. This was achieved by adjusting R_c/H_{m0} of each data point by the roughness factor, $\gamma_f=0.45$ for the FEUP data and the calculated modified roughness factor of each test for the LNEC data discussed above.

The overtopping data obtained at FEUP consists of moderate to high mean discharges which are in the same space as this type of discharges obtained at HR Wallingford. The data from LNEC is also in agreement with the data obtained at HR Wallingford for both moderate high and low discharges.

Discussion

The 2D model tests at HR Wallingford measured wave overtopping on a simple (smooth) 1:2 slope with two different crest heights. It was expected that the main part of the data would be fully explained by the standard EurOtop 2 empirical methods. It is possible to identify in Figure 3 that a large part of the data is indeed within and in very close proximity to the 90% confidence band of the EurOtop 2 empirical formula. A significant proportion of test conditions had been chosen for which low to very low mean overtopping discharges were expected. The objective of producing test data in this space has been effectively achieved. Figure 4 and Figure 5 illustrate the data obtained below the $q/(gH_{m0}^3)^{0.5} = 10^{-5}$ limit suggested by the EurOtop 2 Manual. After analysing the test data obtained, it was decided that overtopping below the dimensionless limit of $q^* = 10^{-8}$ is clearly no overtopping, since the measuring instruments are unable to detect variations smaller than this limit.

Regarding moderate to high mean overtopping discharges, with a relative freeboard $R_c/H_{m0} < 3$, the test data obtained by the three research institutions (HR Wallingford, FEUP and LNEC) are in very good agreement with the empirical prediction given by the EurOtop 2 Manual (EurOtop, 2016). For low overtopping discharges, with a relative freeboard $R_c/H_{m0} > 3$, the test data presents considerable scatter relative to the empirical prediction given by the EurOtop 2 Manual (EurOtop, 2016). It can be identified from Figure 3 that all of the very low overtopping discharges are obtained from low steepness wave conditions, $s_{0m} < 0.03$. Then, these suggest that swell waves may result in significantly less overtopping than storm waves.

Concerning the individual overtopping volumes measured during testing, Figure 7 (HRW) and Figure 11 (FEUP and LNEC) illustrate the distribution of individual volumes as a proportion of the average volume (in the overtopping waves). The test data obtained by the three laboratories are in agreement with $V_i/V_{average} < 10$, hence this might be a reasonable upper limit for individual overtopping volumes. A rapid estimate of V_{max} might simply use the number of overtopping waves, N_{ow} , the mean discharge q , and $V_i/V_{average} = 10$.

Acknowledgements

The original analysis in Figure 1 was suggested by Professor Van der Meer in the revised EurOtop 2 Manual. Further analysis was developed as part of HR Wallingford's design of model tests for the HYDRALAB+ project RECIPE Task 8.2. Additional material has been contributed by LNEC from Dr Reis's post-doctoral studies financed by Fundação para a Ciência e a Tecnologia, Portugal and by FEUP model test results for the HYDRALAB+ project RECIPE Task 8. All Task 8.2 partners gratefully acknowledge support from the European Commission under research agreement 654110 and very helpful support from Frederic Moulin (IMFT) and Bas Hofland (Deltares/TUD).

References

- Besley P. (1999) *Overtopping of seawalls – design and assessment manual*, R & D Technical Report W 178, ISBN 1 85705 069 X, Environment Agency, Bristol.
- EurOtop (2007) Editors: Pullen T., Allsop, N.W.H., Bruce T., Kortenhaus A., Schüttrumpf H. & van der Meer, J. W. *EurOtop: Wave Overtopping of Sea Defences and Related Structures: Assessment Manual*, pdf download available from : www.overtopping-manual.com
- EurOtop, (2016). *Manual on wave overtopping of sea defences and related structures. An overtopping manual largely based on European research, but for worldwide application*. Van der Meer, J.W.
- Allsop, N.W.H., Bruce, T., De Rouck, J., Kortenhaus, A., Pullen, T., Schüttrumpf, H., Troch, P. and Zanuttigh, B., www.overtopping-manual.com
- Owen M W (1980) *Design of sea walls allowing for wave overtopping* Report EX 924, Hydraulics Research, Wallingford.
- Reis MT, Neves MG, Hedges TS (2008) *Investigating the lengths of scale model tests to determine mean wave overtopping discharges*, Coastal Engineering Journal, World Scientific, 50(4), pp441-462.
- Romano A, Bellotti G, Briganti R, Franco L (2015) *Uncertainties in the physical modelling of the wave overtopping over a rubble mound breakwater: The role of the seeding number and of the test duration*, Coastal Engineering, 103, pp15-21.