

ISOPRENE AND ITS OXIDATION PRODUCTS, METHYL VINYL KETONE AND METHACROLEIN, IN THE RURAL TROPOSPHERE

S. A. Montzka,¹ M. Trainer,² P. D. Goldan, W. C. Kuster, and F. C. Fehsenfeld²

Aeronomy Laboratory, National Oceanic and Atmospheric Administration, Boulder, Colorado

Abstract. The mixing ratios of methyl vinyl ketone ($\text{CH}_2=\text{CHCOCH}_3$) and methacrolein ($\text{CH}_2=\text{C}(\text{CH}_3)\text{COH}$) were measured at a site located in the Kinterbish Wildlife Management Area in western Alabama. The measurements were made between June 15 and July 20, 1990. Considering all the data over the whole measurement period, the concentrations of these two carbonyls were approximately equal at this isolated rural site. The average mixing ratios for methyl vinyl ketone and methacrolein were 0.98 parts per billion by volume (ppbv) and 0.66 ppbv, respectively, while the medians were 0.87 ppbv and 0.57 ppbv. The methyl vinyl ketone mixing ratio varied from 3.4 ppbv to the detection limit of the instrument, ≈ 0.01 ppbv, while the methacrolein mixing ratio varied from 2.6 ppbv to 0.027 ppbv. These carbonyls constituted a significant fraction of the volatile organic compounds observed at the site: their mixing ratios, measured 2 m above the top of the forest canopy, were less than that of the dominant compound isoprene but were considerably greater than the mixing ratios of anthropogenic compounds (e.g., benzene). The mixing ratios of methyl vinyl ketone and methacrolein were found to be highly correlated and exhibited a systematic variation with respect to each other. On average, during the day, methyl vinyl ketone was larger than methacrolein, while methacrolein tended to be slightly larger during the night. The systematic behavior of these compounds with respect to each other and other compounds measured at the site were simulated using a one-dimensional photochemical model. These observations were consistent with the production and loss of isoprene, methyl vinyl ketone, and methacrolein by photochemical oxidation reactions.

1. Introduction

The emission of isoprene from vegetation constitutes a significant input of nonmethane reduced carbon to the atmosphere [Lamb et al., 1987; Rasmussen and Khalil, 1988] strongly influencing global and regional chemistry. One of the longer-lived by-products of this oxidation is carbon monoxide, and, on a global scale, the oxidation of isoprene has been estimated to account for as much as 39% of global CO production [Zimmerman et al., 1978, 1988]. Carbon monoxide, in turn, plays a significant role in establishing the ozone budget of the troposphere. On regional scales the photooxidation of isoprene in the presence of sufficient NO_x ($\text{NO}_x = \text{NO} + \text{NO}_2$) can result in the production of significant quantities of ozone and attendant elevated ozone levels in rural areas during the summer [Trainer et al., 1987]. Moreover,

¹Now at Climate Monitoring and Diagnostics Laboratory, National Oceanic and Atmospheric Administration, Boulder, Colorado.

²Also at Cooperative Institute for Research in Environmental Sciences, University of Colorado, Boulder.

Copyright 1993 by the American Geophysical Union.

Paper number 92JD02382.
0148-0227/93/92JD-02382\$05.00

modeling studies have indicated that isoprene oxidation may also be partially responsible for elevated levels of ozone that are observed in many urban areas of the United States [Chameides et al., 1988].

Besides carbon monoxide the oxidation of isoprene in the atmosphere produces a wide range of compounds, including aldehydes, ketones, organic acids, organic nitrates, and other compounds. It has been suggested that organic acids thus produced may affect the level of acidity in precipitation in forested areas [Andreae et al., 1988; Jacob and Wofsy, 1988, 1990; Calvert and Stockwell, 1984; Keene and Galloway, 1984]. To date, only a limited number of field studies have been undertaken to characterize the photo-oxidation products of isoprene [Pierotti et al., 1990; Martin et al., 1991]. Two major compounds produced in the OH and ozone-initiated oxidation of isoprene are thought to be methyl vinyl ketone ($\text{CH}_2=\text{CHCOCH}_3$, which will be referred to in this text as MVK) and methacrolein ($\text{CH}_2=\text{C}(\text{CH}_3)\text{COH}$, referred to as MACR). Thus far, for MVK and MACR only two sets of field measurements have been reported, and these studies arrived at contradictory conclusions. Martin et al. [1991] observed generally higher levels of MVK than MACR during the daylight hours. This is expected on the basis of OH-driven chemistry [Kleindienst et al., 1982; Atkinson et al., 1982; Tuazon and Atkinson, 1990; Atkinson, 1990; Fehsenfeld et al., 1992]. By contrast, Pierotti et al. [1990] generally observed higher levels of MACR than MVK and suggested that this could not be explained with the current understanding of odd-hydrogen radical driven oxidation of isoprene.

Chamber experiments have been done to elucidate the atmospheric oxidation chemistry of isoprene. However, these studies have been done with mixing ratios of isoprene that are approximately 3 orders of magnitude higher than levels typically observed in the atmosphere [Tuazon and Atkinson, 1990; Gu et al., 1985]. In addition, these studies were performed in the presence of high levels of NO_x . This could drastically affect the odd-hydrogen radical concentration and speciation and produce nonrepresentative branching ratios of certain reactions of free radicals formed in the photooxidation of hydrocarbons.

Clearly, more ambient measurements of these carbonyls, along with their hydrocarbon precursors, are required to help resolve some of these uncertainties and better establish the mechanisms responsible for the oxidation of isoprene. This is, however, a difficult challenge in the rural troposphere, given the complex matrix of sources for a large variety of volatile organic compounds. These sources may confuse interpretation of results by providing alternative sources of the carbonyls, either by direct emission or as oxidation products of other hydrocarbons that are emitted. Hence, the aim of this study is to produce an adequate data base that can establish if isoprene oxidation is the source of methyl vinyl ketone and methacrolein at a rural location where isoprene is the dominant non-methane hydrocarbon (NMHC) and, if so, to determine if our present understanding of photochemistry can explain the interrelationships that are observed among MVK, MACR, and isoprene.

A field experiment that took place in the rural southeastern United States in the summer of 1990 provided a unique opportunity to address these questions.

2. Experimental Details

2.1. Site Characteristics

The measurements were performed between June 15 and July 20, 1990, at a rural site in western Alabama. A number of other measurements were performed in conjunction with the measurements reported here. The site location is shown in Figure 1. This location is a designated site of the South East Network for Intensive Oxidant Research (SENIOR) and the Southern Intensive Ozone Network (SION) of the Southern Oxidant Study (SOS). The site, which is in an area of reasonably uniform terrain in a forest plantation and designated wildlife management area (Kinterbish Wildlife Management Area), is located approximately 50 km from Meridian, Mississippi (approximate population, 46 K, 1980 census). Larger metropolitan areas are much further from the site (Montgomery, Alabama, ~200 K - 175 km; Birmingham, Alabama, ~290 K - 200 km; Mobile, Alabama, ~360 K - 210 km; New Orleans, Louisiana, ~ 560 K - 340 km).

Although the larger urban centers are sources of significant amounts of anthropogenic volatile organic compounds, the site is immediately surrounded by an area of relatively low anthropogenic emissions. The anthropogenic hydrocarbons that were measured were predominately the alkanes with concentrations of aromatics, such as benzene, approximately an order of magnitude lower than that of propane. At the site during the daytime these anthropogenic NMHC accounted for less than 20% of the nonmethane volatile organic carbon that was measured [Goldan et al., 1990]. In contrast, due to the high temperatures and heavy forestation there are very high emissions of natural nonmethane hydrocarbons, principally, isoprene and terpenes. At this site during the day these NMHC accounted for approximately 50% of the nonmethane volatile organic carbon that was measured [Goldan et al., 1990]. The remaining nonmethane volatile organic carbon, approximately 35%, was present as carbonyls, including light alcohols, acetaldehyde, light ketones, MVK, and MACR.

2.2. Sampling and Detection

The measurement of methyl vinyl ketone, methacrolein, acetone, and methyl ethyl ketone was performed in the field with a fully automated multicolumn gas chromatographic instrument contained in a mobile laboratory. Multicolumn (two dimensional) gas chromatography, which has been used

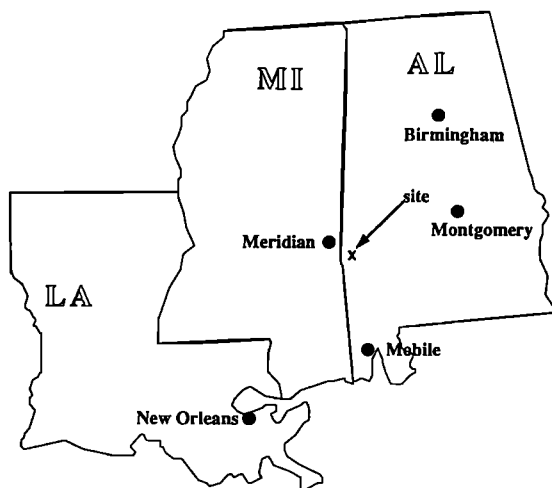

Fig. 1. Map of the area surrounding the study site (indicated by the cross) which is located in the Kinterbish Wildlife Management Area in Alabama. Principal urban centers in the area are also indicated.

before for the measurement of carbonyl compounds in air [Jonsson and Berg, 1983; Pierotti, 1990], enables efficient separation of carbonyl compounds from water and most saturated hydrocarbons. In addition, the analysis can be tailored so that the final chromatogram contains only a small number of peaks, thereby reducing the chances for inaccurate quantitation due to coelution of different compounds.

A schematic representation of the system is shown in Figure 2. Air was sampled through a glass mast with an internal diameter of 7.6 cm that was 14 m high (approximately 1 to 2 m above the top of the forest canopy). Air at approximately 125 STP L/min was drawn through this mast by an exhaust fan mounted in its base. A portion of the airflow in the mast (0.05 STP L/min) was diverted from the center of the mast flow into the carbonyl analysis system via a 1/8-inch Teflon line. Hence, prior to injection into the analysis system, the sample contacted only surfaces made of glass or Teflon. The transfer lines from the mast to the system were maintained at 50°C to avoid possible condensation of water and losses of methyl vinyl ketone.

Upon entering the analysis system, the air was drawn through an ozone destruction device that consisted of 0.75 g of anhydrous Na_2SO_3 maintained at 50°C. The Na_2SO_3 was contained in a 1/4-inch diameter glass tube and held in place with silanized glass wool plugs. The removal of ozone contained in an air sample is necessary to prevent the production of methyl vinyl ketone and methacrolein from isoprene ozonolysis within the cryogenic sample trap [Kuster et al., 1990]. Such reactions between compounds present at concentrations greatly above ambient levels occur in a cryogenically collected sample when the sample is heated for transfer onto a chromatographic column. Without this ozone destruction device, significant errors in the measurement of MACR and MVK would result. Tests have shown that this trap removes over 99% of the ozone in a humid ambient air stream but alters the concentration of the target carbonyls, methyl vinyl ketone and methacrolein, by less than 5%. During the measurement campaign, ozone destruction efficiency was tested on a routine basis and the traps were changed 1 - 2 times per day.

It was also found that the ozone destruction efficiency and MVK and MACR throughput for traps filled with Na_2SO_3 obtained from different suppliers or even from different batches from the same supplier was not always reproducible. This lack of reproducibility appeared to be related to surface contamination present on some of the Na_2SO_3 batches and necessitated rigorous testing prior to use and throughout the field program.

After ozone removal, each air sample was cryogenically concentrated by allowing it to pass through a 25-cm-long loop of 1/8-inch Teflon tubing immersed in liquid nitrogen. The loop contained a short plug of silanized glass wool to maximize collection efficiency and avoid losses due to aerosol formation. Ambient air samples were acquired for 5 min at a flow rate of ~50 STP cm^3/min once every hour, 24 hours a day. Sample volumes, typically ~0.250 STP L, were measured barometrically by monitoring the pressure accumulated in a previously evacuated, calibrated volume downstream of the cryogenic sample loop. Since the sample pressure never exceeded 50 torr, no liquid oxygen was accumulated. After acquisition the sample was warmed from liquid nitrogen temperature to ~100°C in about 20 s by resistive heating which allowed for the vaporization of all condensates in the cryotrap, including water.

The gases evolved from the cryotrap were carried by hydrogen carrier gas onto the precolumn by actuating the first 6-port valve (see Figure 2). The precolumn consisted of 120 mesh Chromosorb W-HP coated with 8% TCEP packed in a 1/8-inch x 6 m Teflon tube and served to separate the carbonyl compounds from water and most of the nonpolar hydrocarbons. Selective collection of the carbonyl compounds, and a few nonpolar compounds including benzene, occurred in the second cryotrap which consisted of a

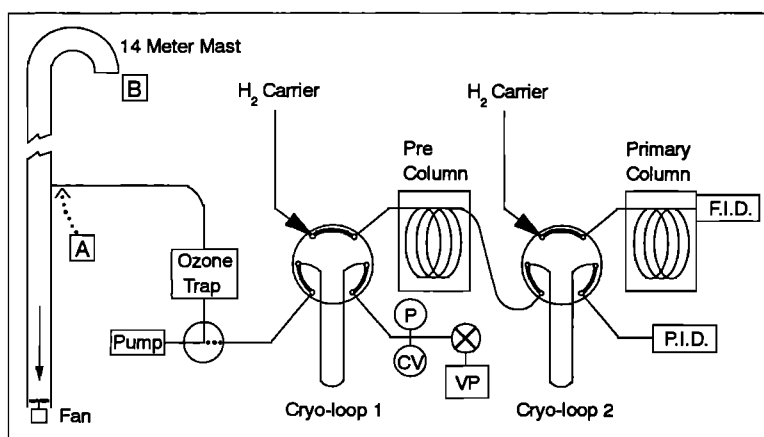

Fig. 2. Schematic representation of the system used to measure the carbonyls. Standards were routinely fed into the inlet at point A. Symbols are as follows: P, pressure transducer; CV, calibrated volume; VP, vacuum pump; F.I.D., flame ionization detector; P.I.D., photoionization detector.

5-cm length of 0.32 mm ID DB-5 capillary column with a 1- μ m film thickness maintained at -190°C . After a preset collection time the selected components from the original sample were passed onto the primary analytical column by actuating the second 6-port valve (see Figure 2) and heating the second cryosample loop. Final analyte separation was performed on a 0.32-mm ID DB-624 capillary column 30 m long and compounds were detected with a flame ionization detector (FID). Total sample acquisition, separation, and detection took less than 30 min.

2.3. Calibration Standards

Calibration standards were generated by dynamic dilution of primary gas standards at the sampling site. The primary standards consisted of cylinders containing 6-8 components of different polarity and volatility at concentrations varying from 5 to 25 parts per million by volume (ppmv). These primary standards had been prepared gravimetrically by established techniques in 6 L Acculife-treated aluminum cylinders pressurized with synthetic air to ~ 2000 psig [Rhoderick and Zielinski, 1988]. The dynamic dilution system allowed for the routine dilution of gas from the primary standards down to the 0.25-5.0 ppbv range and the addition of ambient levels of CO_2 , H_2O and ozone to the airstream, in order to simulate ambient air as closely as possible. This allowed routine field testing of the whole analytical procedure for collection efficiency, response, and freedom from interferences caused by these major atmospheric constituents. Calibration samples were analyzed an average of 3 times per day during the entire field program.

The calibration samples were introduced into the instrument at point A in Figure 2 and therefore passed through the entire sampling system with the exception of the 14-m glass sampling mast. In this way, any systematic compound losses in the analytical train were automatically compensated for even though they were routinely less than 10%. On several occasions, tests for compound losses in the sampling mast were done by introducing small flows (~ 10 STP cm^3/min) of the primary gravimetric standards at the inlet to the glass mast (point B in Figure 2). Compounds entering the glass mast in this way were diluted by the large volume of gas being drawn through the glass mast (~ 125 STP L/min). These tests indicated that no detectable losses of the carbonyl compounds occurred in the sample mast.

The accuracy and precision of these measurements rests upon both the integrity of the parts per million by volume level gravimetrically prepared standards and the performance of the dynamic dilution system used to dilute these standards down

to the sub-parts per billion by volume range. While the stability of standards prepared in treated aluminum cylinders has been studied for a number of alkanes, alkenes, and aromatic compounds, far less information is available for more polar compounds such as aldehydes and ketones. Rhoderick and Zielinski [1988] reported that methyl ethyl ketone and acetone were stable in aluminum cylinders at 11 and 47 ppbv, respectively. We evaluated standards containing acetaldehyde, methacrolein, methyl vinyl ketone, methyl ethyl ketone, and acetone at the 5 to 25 ppmv level in treated aluminum cylinders using four different approaches: (1) comparison of standards that had been prepared at different times, typically 1 year apart; (2) comparison of the relative responses of polar to nonpolar compounds contained in the same cylinder over time, typically 1 year; (3) comparison of standards prepared using gravimetrically calibrated permeation devices with those prepared as described above; and (4) the determination of the total carbon mixing ratio in a prepared standard containing only methyl vinyl ketone. None of these tests indicated any detectable compound loss over the time period involved or difficulties in preparation reproducibility or precision at the 10 ppmv level.

The characteristics of the dynamic dilution system used have been well documented by Goldan et al. [1986]. During field operation the precision of the measurements was limited by the reproducibility of this dilution system and was $\sim 10\%$.

2.4. Sample and Data Acquisition

Samples were collected each hour commencing at 10-min before the hour, while a calibration run was made each hour at 20 minutes after the hour during the daytime. Figure 3 shows a sample chromatogram of an ambient air sample and a chromatogram of a calibration sample taken by the system during the study. Compounds were identified by using relative retention times. Data analysis was performed with a computer-based data acquisition and analysis software program (Dynamic Solutions Corporation). Data integrity was assured by visually reviewing each integration performed by the software. The present system has a detection limit of 0.01 ppbv for the analysis of methyl vinyl ketone and methacrolein in a 0.25 STP L sample of ambient air.

3. Results

The results of over 500 ambient air measurements of MVK and MACR during the study are presented in Figure 4. As indicated by the bar graph, the mixing ratios of MVK ranged from below the detection limit, ≈ 0.01 ppbv, to 3.4 ppbv,

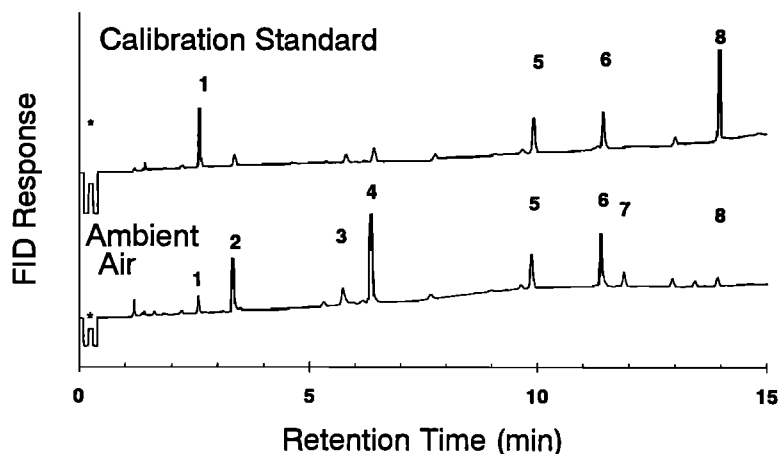

Fig. 3. Typical chromatograms made with the carbonyl measurement system. The top trace indicates a calibration run while the bottom trace indicates the results obtained from a 0.25 STP L ambient air sample collected at 1150 CST on July 9, 1990. The identification of the peaks are as follows: (1) acetaldehyde, (2) methanol, (3) ethanol, (4) acetone, (5) methacrolein, (6) methyl vinyl ketone, (7) methyl ethyl ketone, (8) benzene. Mixing ratios in the standard sample are as follows: (1) acetaldehyde, 2 ppbv; (5) methacrolein, 0.82 ppbv; (6) methyl vinyl ketone, 0.86 ppbv; (8) benzene, 0.84 ppbv.

while those of MACR ranged from 0.027 ppbv to 2.6 ppbv. The median and average mixing ratios were 0.87 and 0.98 for MVK and 0.57 and 0.66 for MACR.

The concentrations of the two compounds were strongly correlated. Figure 5 shows a plot of the mixing ratios of MACR versus MVK for daytime hours (800 to 1800 CST) shown as the open circles and nighttime hours (2000 to 600 CST) shown as the solid circles. The square of the correlation coefficient (R^2) for the correlation between the mixing ratios of

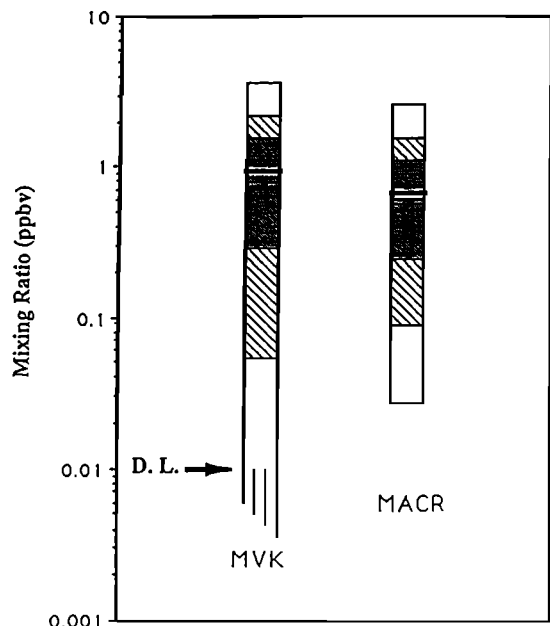

Fig. 4. Bar graph indicating the range of MVK and MACR mixing ratio measured during the study. The full rectangles encompass all of the measurements made during the period; the hatched region indicates the central 90% of the measurements; and the shaded area indicates the central two thirds of the measures. The solid bar indicates the average while the broken bar indicates the median. The "lined" lower portion of the bar for the MVK indicates that measured concentrations of MVK were occasionally at or below the detection limit (DL) of the instrument, which as indicated on the graph was approximately 0.01 ppbv for MVK.

these and other species are listed in Table 1. The R^2 for the daytime points was 0.822, while the R^2 for the nighttime points was 0.935. Two other aspects of the relative concentrations of these two species are apparent from this plot. First, the range of the mixing ratios of these compounds is much greater during the night, and, in particular, lower mixing ratios are observed. Secondly, there is a systematic increase of MVK mixing ratios relative to MACR mixing ratios during the day. These results imply that the sources of these compounds are daytime sources and that the production is greater and/or the loss less for MVK with respect to MACR during the day.

Comparisons of the measured mixing ratios of MVK with the biogenically emitted isoprene, the principal NMHC measured at the site, and benzene, an aromatic compound commonly used as an anthropogenic tracer [Roberts et al., 1984a, b, 1985; Pierotti et al., 1990], are shown in Figure 6. The R^2 for the correlation between isoprene and MVK was modest, 0.443, while that between MVK and benzene was substantially less, 0.125 (not significantly different from zero). The absence of a very strong correlation between the carbonyls and either the biogenically emitted, isoprene, or the anthropogenically emitted, benzene, suggests that these carbonyls have a significantly different atmospheric evolution than either of these primary NMHC emissions.

The modest correlation that exists between MVK and isoprene is indicated by the data plotted through the diurnal cycle as shown in Figure 7. The solid diamonds are the averaged MVK mixing ratios and the open squares are the averaged isoprene mixing ratios that were measured during each diurnal hour. Thus each symbol is the average of 20-25 measurements. The vertical bars drawn in the figure represent the standard deviation of the mixing ratio for each hour. The mixing ratios of both MVK and isoprene exhibit maxima during the day and minima during the night, just prior to sunrise. A similar pattern is exhibited by MACR.

Likewise, the mixing ratios of isoprene, MVK, and MACR are all correlated with temperature. Isoprene emissions are known to be temperature and light dependent [Lamb et al., 1987; Placet et al., 1990], and the correlation between either MVK or MACR and temperature can be attributed to their production from isoprene in the atmosphere. Benzene, however, does not exhibit any correlation with temperature at this site.

The relative concentrations of the primary NMHC to MVK and MACR during the photochemically active periods also has important implications. Between the hours of 0900 and 1500, average mixing ratios of MVK and MACR were determined to

TABLE 1. The Square of the Correlation Coefficient, R^2 , for the Correlation Between the Mixing Ratios of MVK and the Mixing Ratios of Several Compounds

	MVK	Period
MACR	0.822	800 - 1800
MACR	0.935	2000 - 600
Isoprene	0.490	all points
Benzene	0.125	all points

Times are military, central standard time (CST). MVK, methyl vinyl ketone; MACR, methacrolein.

be 1.4 and 0.7 ppbv, respectively. In comparison, the mixing ratio of isoprene was substantially larger, typically 2 to 3 times higher than the sum of the mixing ratios of MVK and MACR during midday. By contrast, during the night, when the emissions of isoprene are small, the sum of MVK and MACR often exceeded the levels of isoprene. However, during the course of the measurements, the ratio of benzene concentration to the sum of the concentrations of MVK and MACR averaged only 0.10 for samples taken during this same period.

The relative variations of MVK and MACR during the diurnal cycle are shown in Figure 8. The open circles are the averaged MVK and the squares the averaged MACR mixing ratios that were measured during each diurnal hour. As before, each symbol is the average of 20-25 measurements and the vertical bars represent the standard deviation of the mixing ratios. The mixing ratios of MVK and MACR generally exhibit maxima during the day and early evening and minima during the night, just prior to sunrise. The fluctuation of the measurements about the average was greater during the night, a common observation in most of the volatile organic compounds. This probably results from reduced mixing in the atmosphere during the night and variability in the height and stability of the near-surface nocturnal inversion.

The ratio of MVK to MACR is plotted versus time of day as the open triangles in Figure 9. The relationship between the two compounds that was seen in Figure 5 is demonstrated more vividly here. From Figure 9 it is apparent that this ratio is not constant during a diurnal cycle but is much larger during the daylight hours than at night. The mixing ratio of MVK is typically two times greater than MACR during midday, but during the night the mixing ratios of the two compounds are very similar. In addition, whereas the standard deviations displayed in Figure 8 demonstrate that the mixing ratios of MVK and MACR vary extensively, the standard deviation of the ratios of the concentrations of these compounds is much smaller than that of either compound individually.

4. Discussion

4.1. Sources of Methyl Vinyl Ketone (MVK) and Methacrolein (MACR)

Although MVK and MACR are produced in the photooxidation of nonmethane hydrocarbons in the atmosphere, the direct emission of these carbonyls from anthropogenic sources has been observed [Jonsson et al., 1985]. However, the amount of carbonyls, compared to the amount of other nonmethane volatile organic carbon (NMVOC), introduced annually into the atmosphere of the United States from anthropogenic sources appears to be small. Placet et al. [1990] indicated that the emission of higher ketones, presumably including MVK and MACR, constitute only 0.75% by weight of the NMVOC from anthropogenic sources. This estimate for the United States is supported by a study carried out in Sweden by Jonsson et al. [1985] that found the amount of MVK and MACR emitted relative to more

common anthropogenic emissions is small. For example, in the urban center (Stockholm) where those measurements were made, although there was a strong correlation between benzene and both MVK and MACR, the ratio of the benzene concentration to that of MVK or MACR was greater than 60. By contrast, at the rural site, where the present study was made, the concentrations of MVK and MACR are typically an order of magnitude larger than benzene and show no correlation with benzene.

It is also possible that the carbonyl compounds are emitted from the surface of the plants, either directly as a by-product of plant metabolism or by ozonolysis of NMHC on plant surfaces. To date, however, limited measurements available indicate no direct emission of these carbonyl compounds from plants [Pierotti et al., 1990; Goldan, private communication (1991)]. Accordingly, as a working hypothesis, we will assume that MVK and MACR are produced photochemically in the atmosphere by NMHC oxidation.

There are large quantities of anthropogenic NMHC emitted into the atmosphere. The majority of these emissions, however, occur near major urban centers. However, the present study was carried out at a rural, forested site. Correlation coefficients between benzene and these carbonyls were not significantly different from zero at the 95% confidence level (that is, the R^2 for mixing ratios between MVK and benzene was 0.125; between MVK and toluene, 0.039). This is illustrated in Figure 6. The solid circles in this figure indicate simultaneously measured mixing ratios of MVK versus those of benzene. Likewise, the concentration of anthropogenic compounds capable of producing MVK and MACR (that is, such as the C_4 or greater alkanes) was small compared to that of MVK and MACR and was not correlated with these carbonyls [Goldan et al., 1990]. Given that the lifetimes for the formation and destruction of MVK and MACR are short (less than 1 day), these relative concentrations cannot account for the amount of MVK and MACR that was observed. Hence, we conclude that the influence of anthropogenic NMHC oxidation on the concentration of MVK and MACR measured at this site during this time period was negligible.

The atmospheric oxidation of isoprene has been discussed in detail by several authors [Kleindienst et al., 1982; Atkinson et al., 1982; Lloyd et al., 1983; Tuazon and Atkinson, 1990; Atkinson, 1990]. Some important implications of the proposed

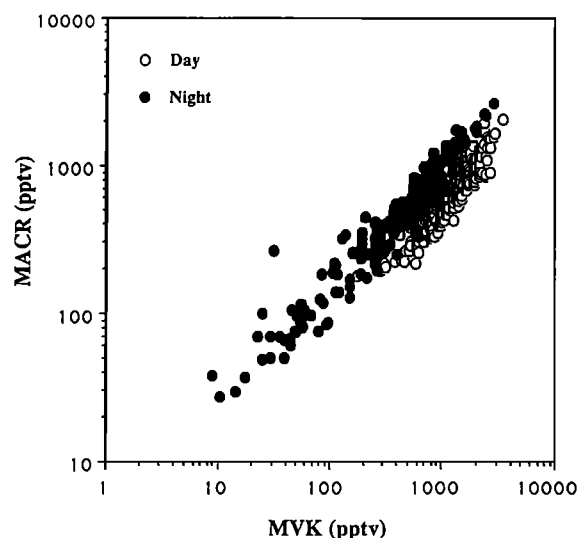

Fig. 5. Mixing ratio of MACR versus that for MVK. The open circles indicate daytime measurements, 800 - 1800 CST, while the solid circles indicate nighttime measurements, 2000 - 600 CST.

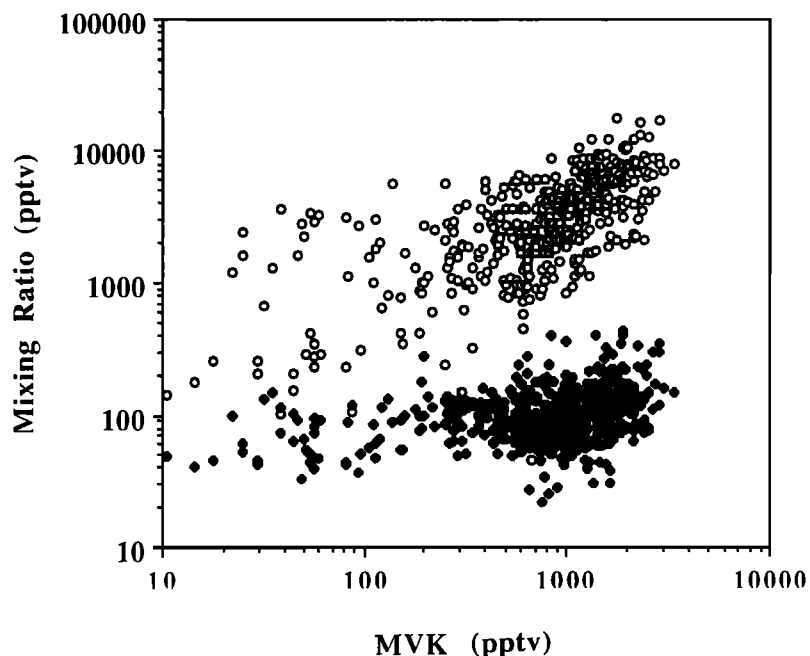

Fig. 6. Mixing ratio of isoprene (open circles) and benzene (solid circles) versus MVK.

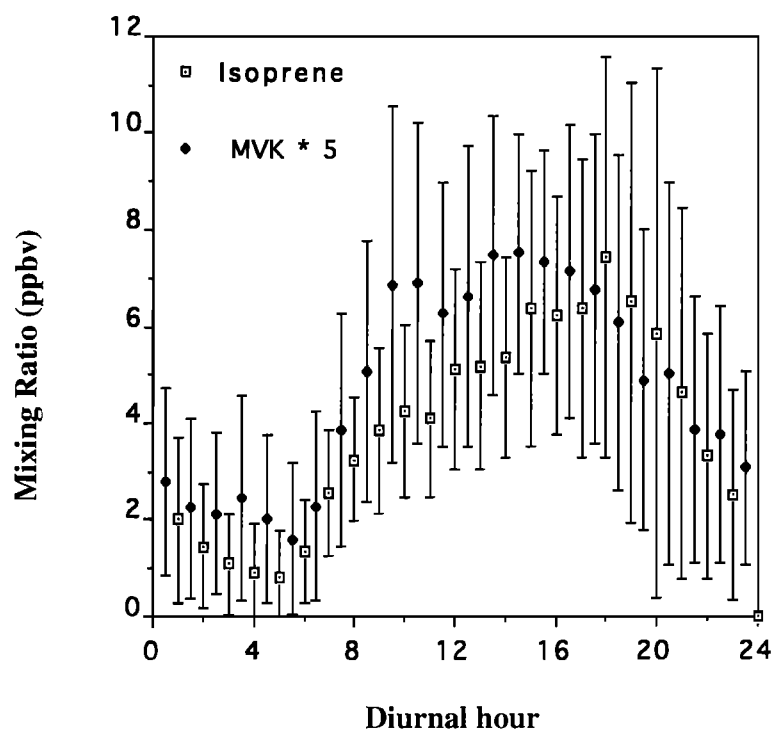

Fig. 7. The diurnal trends in isoprene and MVK. The average mixing ratios of isoprene and MVK (x5) for each diurnal hour are shown as the symbols. The bars indicate the standard deviation of the measurements for each hour.

oxidation mechanism for relevant daytime chemistry are listed in Table 2 and illustrated in Figure 10 in which the size of the arrows is proportional to the relative reaction rates of these compounds during the daytime, assuming an OH concentration of $2 \times 10^6 \text{ cm}^{-3}$ and an ozone concentration of 50 ppbv. MVK and MACR are produced in the oxidation of isoprene by either ozone or the hydroxyl radical (OH). Assuming typical midday concentrations expected for these

oxidants, the half-lives of isoprene in the atmosphere due to the reaction with OH and ozone are calculated to be 1.4 hours and 20 hours, respectively. Consequently, the principal oxidation path for isoprene during the day is probably initiated by reaction with OH. During the night, however, oxidation of isoprene by ozone, and perhaps NO_3 [Kleindienst et al., 1982; Atkinson et al., 1982; Lloyd et al., 1983; Atkinson, 1990], could influence mixing ratios of MVK and MACR. Chamber

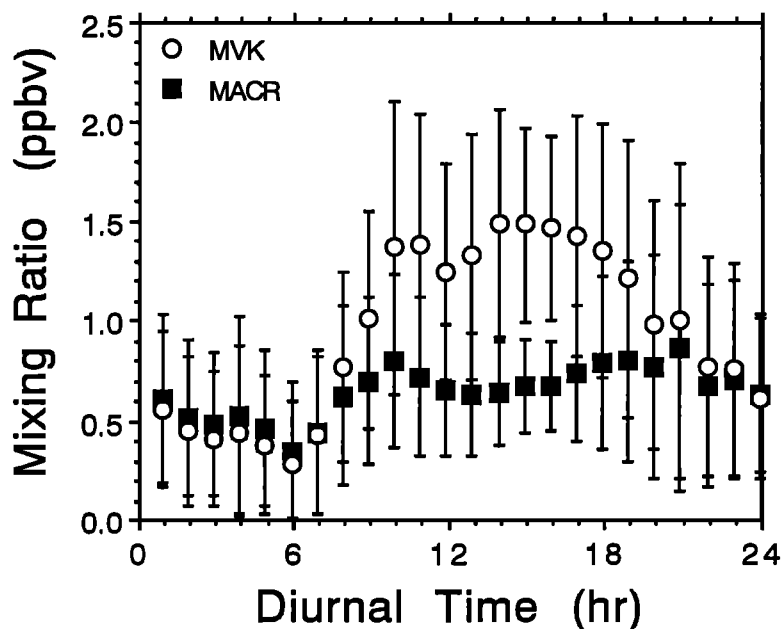

Fig. 8. The diurnal trends in MACR and MVK. The average mixing ratios of MACR and MVK for each diurnal hour are shown as the symbols. The bars indicate the standard deviation of the measurements for each hour.

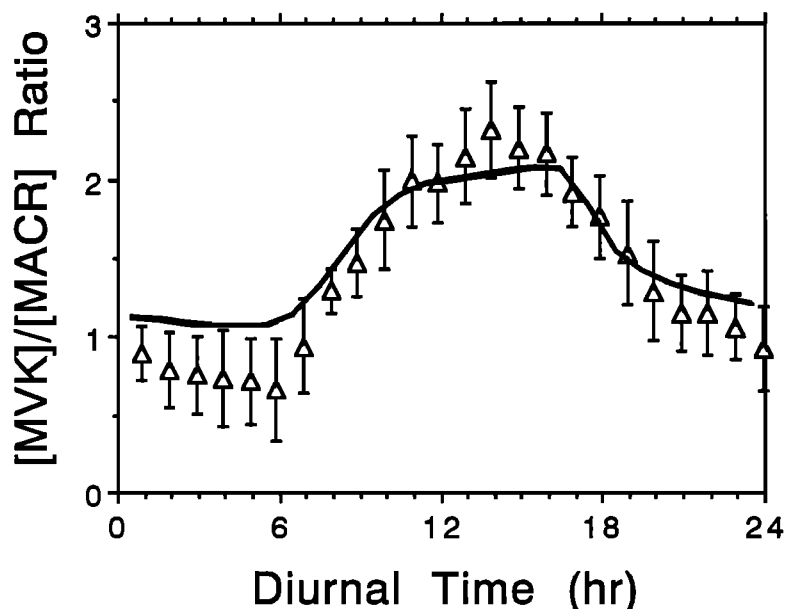

Fig. 9. The diurnal trends in the ratio of the concentration of MVK relative to that of MACR. The triangles are the average of measurement made during this period for each diurnal hour. The vertical bars are the standard deviations. The solid line is the predicted ratio from the one-dimensional model calculation.

studies by Kamens et al. [1982] have indicated that MACR will predominate over MVK in ozone-dominated oxidation of isoprene, MVK, and MACR. It should be noted that under typical atmospheric conditions, time constants for ozone-driven chemistry are sufficiently long so that steady state will not be attained during the course of a single night. While the loss of either MVK or MACR by reaction with NO_3 is expected to be insignificant even at night [Fehsenfeld et al., 1992], the product yields of MVK and MACR from the reaction between isoprene and NO_3 have not been determined. Thus it is difficult to predict the impact of NO_3 chemistry on the mixing ratios of these carbonyls during the night.

The hydroxyl radical reacts with isoprene by addition to one of the carbon-carbon double bonds. A certain percentage of the organic odd-hydrogen radicals (R) that result will add O_2 to form four possible isomeric peroxy radicals (RO_2) that may in turn react with NO to form either MVK or MACR [cf., Lloyd et al., 1983; Tuazon and Atkinson, 1990], as well as other products. In the rural atmosphere during the daytime the time scales for these latter two reaction steps will be very short (typically, minutes or less). Thus the formation of MVK and MACR by these reactions seems to be the most likely immediate consequence of isoprene photooxidation. Chamber experiments by Tuazon and Atkinson [1990] indicate that the

TABLE 2. Relevant Reactions for Daytime Oxidation of Isoprene, Methyl Vinyl Ketone, and Methacrolein

	Oxidation	
	OH (2×10^6)	O ₃ (50 ppb)
<i>Photochemical Sources</i>		
$t_{1/2}$ Isoprene (hours)	1.4	20
Relative yield, MVK:MACR	~3:2	~2:3
<i>Photochemical Sinks</i>		
$t_{1/2}$ Methyl vinyl ketone	8	50
$t_{1/2}$ Methacrolein	4.5	210

Adapted from Trainer et al. [1987], Atkinson [1990], Tuazon and Atkinson [1990].

relative yields of MVK to MACR by this OH-initiated chemistry is approximately 3:2. The predominance of MVK production over MACR has also been suggested from empirical considerations of hydroxyl reaction rate constants with structurally related alkenes [Ohta, 1983; Atkinson, 1990].

MVK and MACR also react with both OH and O₃. Their half-lives (assuming an OH concentration of 2×10^6 and an ozone mixing ratio of 50 ppbv) are also listed in Table 2 and illustrated in Figure 10. These half-lives indicate that the oxidation of MACR will be dominated by the reaction with OH. However, the oxidation of MVK, while principally due to OH, will be influenced by the ozone reaction.

4.2. Model Simulations

In order to simulate the diurnal pattern of the isoprene chemistry, a high-resolution, one-dimensional, planetary boundary layer (PBL) model developed by Trainer et al. [1987] was used. This model incorporates the isoprene-initiated chemical reactions following the reaction mechanism proposed by Lloyd et al. [1983] and updated as outlined by Trainer et al. [1991]. The reaction of OH with isoprene leads to the formation of four isomeric peroxy radicals, as

mentioned above. In this model study it was assumed that the reaction of these peroxy radicals with NO yields 10% organic nitrates, along with 90% formaldehyde and either methyl vinyl ketone or methacrolein. While earlier studies assumed a branching ratio of MVK to MACR of 1:1, the present study prescribes a branching ratio of MVK to MACR of 3 to 2 (cf., Table 1, Figure 10) following the results of the recent study by Tuazon and Atkinson [1990]. It should be noted here that the study by Tuazon and Atkinson further showed that methylfuran is an additional reaction product in the isoprene oxidation and that the sum of CH₂O, MVK, MACR, and methylfuran accounted for only approximately 55% of the isoprene which reacted [Tuazon and Atkinson, 1990]. It was proposed in the study that the balance of the isoprene consumed could possibly be accounted for by organic nitrates (estimated yield of 12%) and other carbonyls (estimated yield of 25%). These uncertainties in the OH-initiated oxidation of isoprene have to be kept in mind in the comparison of the experimental results with the predictions of the model. Larger uncertainties exist for the product formation in the reaction of isoprene with O₃ and NO₃.

The loss processes of MVK and MACR that are included in the model description are reaction with OH and O₃, and loss due to surface deposition for which a species specific deposition velocity of 0.3 cm/s was assumed. The model did not include the photolysis of either MVK or MACR. Although the photolysis rates of these carbonyls have not been reported, photolysis rates of acrolein and acetone [Meyrahn et al., 1986; Gardner et al., 1987] are much slower than the hydroxyl reaction rates of MVK and MACR. Therefore we expect that the photolysis of MVK and MACR are negligible and can be ignored.

The model was run for a 4-day period, June 24 to June 27, 1990. During this period a high-pressure system over the region controlled the meteorology. The conditions were characterized by slow wind speeds and predominantly sunny skies. The model indicated that OH reactions would dominate the photochemical production and loss of both MVK and MACR during the daytime. The daily evolution of temperature, humidity, and the height of the planetary boundary layer are described by a Blackadar PBL model [Blackadar, 1979; Zhang and Anthes, 1982]. This model also provides the meteorological parameters like heat flux and friction velocity that are used to parameterize the vertical

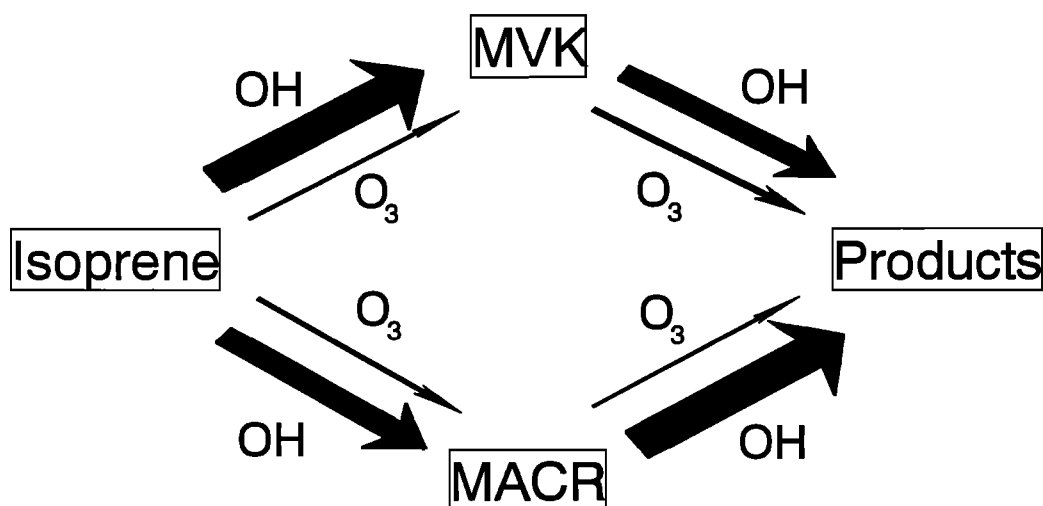

Fig. 10. Diagram illustrating the relevant daytime reaction pathways for the production of MVK and MACR by the oxidation of isoprene by OH and ozone, as well as the destruction of the two carbonyls by their reactions with OH and O₃. The size of the arrows are proportional to the relative reaction rates assuming an OH concentration of $1 \times 10^6 \text{ cm}^{-3}$ and an ozone concentration of 50 ppbv and reaction yields determined by Tuazon and Atkinson [1990] for isoprene oxidation by OH.

diffusion coefficients within the boundary layer and the aerodynamic resistance component of the surface deposition velocity. The initial conditions for the Blackadar model were obtained by interpolation of the soundings of the rawinsonde profiles provided by the National Weather Service Network to obtain conditions representative for the location of the site [Trainer et al., 1991].

As described by Trainer et al. [1991], the isoprene flux is expected to vary with ambient temperature according to Lamb et al. [1987] and to be modulated by light intensity following Jacob and Wofsy [1988]. For this simulation, the isoprene flux for a temperature of 303 K under noontime, clear sky conditions was set to 1.2×10^{16} molecules $m^{-2} s^{-1}$, which roughly corresponds to the expected flux from this forested area (A. B. Guenther, private communication, 1992). This flux yields a daytime isoprene mixing ratio at 5 m of approximately 4 ppbv which is in close agreement with the near-surface observations during this period. A NO_x flux of 1.25×10^{15} molecules $m^{-2} s^{-1}$ was used for the calculations. This yielded an NO_x mixing ratio of 400 pptv in the middle of the day which was within a factor of 2 of the NO_x mixing ratios observed during this period.

The mixing ratios of isoprene and its reaction products are influenced by both dynamical process and photochemistry. The model-predicted daytime mixing ratios of MVK and MACR agree with the values observed during this period within a factor of two but show systematically lower values during the afternoon hours of 26 and 27 June.

To minimize the effect of dynamics on the comparison of model results to measurements, the ratio of MVK and MACR to isoprene and MVK to MACR can be studied. A comparison between the calculated ratio over this 4-day period and the average of this ratio that was measured throughout the campaign is presented in Figure 9. Clearly, the model results are in good agreement throughout the diurnal cycle with the ratio of MVK to MACR that was measured during this campaign. It should be noted that many of the problems that would be encountered in simulating the concentrations of either MVK or MACR were circumvented by using this ratio. For example, the ratio of the two compounds is not very sensitive to the emission rate of isoprene or the height of the mixed layer, while the concentration of either compound will be influenced by both parameters. Nevertheless, the agreement does indicate that the isoprene oxidation following the mechanism outlined in Table 2 provides, on average, a good simulation of the observed ratio of the concentrations of these two compounds at this site.

Likewise, during the daytime hours the model is able to simulate reasonably well the observed ratio of the sum of the concentrations of MVK and MACR to that of isoprene. This is shown in Figure 11. The solid curve indicates the model predicted value for this ratio during this 4-day test simulation, while the solid triangles are the ratio measured during the course of the campaign with the vertical bars indicating the standard deviation in the measured ratio. The shaded portion of the figure is used to indicate the nighttime hours. While during the daytime there is reasonably good agreement between the measured and the calculated ratio, during the night, much larger discrepancies are observed. Unlike the ratio of MVK/MACR, the (MVK plus MACR)/isoprene relationship shown in Figure 11 is influenced more strongly by factors other than chemistry, such as mixed layer depth, deposition rates, and emission rates. During times when the model does not accurately simulate boundary layer dynamics, which is most probable at night given the complex nature of the nighttime boundary layer, we would expect significant discrepancies between measurements and model results.

4.3. Comparison to Prior Measurements

Measurements of MVK and MACR in rural ambient air have been reported previously. Martin et al. [1991] sampled air from a small clearing at a forested site in rural

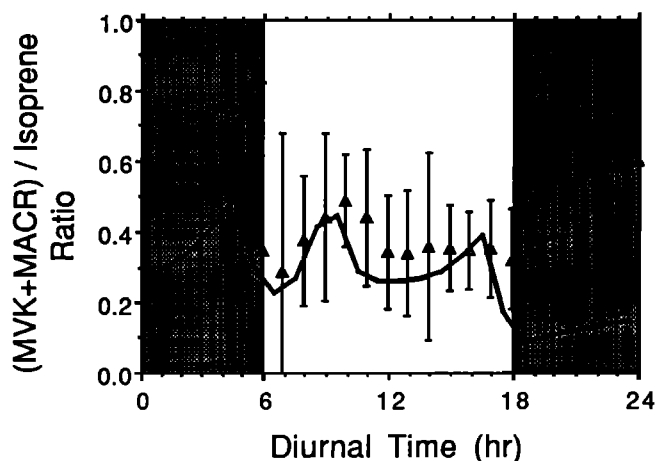

Fig. 11. The ratio of the sum of the concentrations of MVK and MACR to that of isoprene during the diurnal cycle. The solid curve indicates the model-predicted value for this ratio during this four-day test simulation carried out for the period June 24-27. The triangles are the ratios calculated from the measured mixing ratios of MVK, MACR and isoprene made during the course of the campaign. The vertical bars indicate the standard deviation in the measured ratio. The shaded portion of the figure is used to indicate the nighttime hours.

Pennsylvania. Results from Martin et al. [1991] are in general agreement with those reported here. In the present study during the day, the mixing ratio of isoprene was typically 2 to 3 times higher than the sum of MVK and MACR. Likewise, Martin observed average daytime levels of isoprene 1.5 to 3 times higher than the sum of the mixing ratios of MACR and MVK. In addition, Martin observed a similar diurnal pattern of the MVK/MACR ratio: more MVK was present than MACR during the day, and during the night the MVK/MACR ratio decreased so that it was less than or equal to one.

In the only other reported simultaneous measurements of these three compounds, Pierotti et al. [1990] acquired air samples from within forest canopies at a number of different sites in California. They observed significantly higher levels of isoprene when compared to the sum of MVK and MACR. In eight of the nine sites from which they collected samples, an average ratio of isoprene to the sum of the carbonyl compounds of ≈ 7 was found. At the eighth site, a date palm grove in Indio, ratios of <1 were reported. They suggested that the carbonyl compounds are scavenged within a forest canopy more rapidly than isoprene and that different scavenging rates within canopies of different densities could explain the site-to-site differences observed. These effects and the effect of reduced ventilation within a forest canopy could also explain why the isoprene/MVK and isoprene/MACR ratios reported by Pierotti et al. [1990] are different from those reported here and by Martin et al. [1991].

Pierotti et al. [1990] generally observed daytime MVK/MACR ratios less than 1 in air samples obtained within the forest canopy. They could not explain these results with a simple one-dimensional model that incorporated detailed photochemical reaction mechanisms and therefore suggested that the model was inaccurately simulating chemistry at low NO_x levels. The NO_x levels encountered in the present study are typical of NO_x mixing ratios at a reasonably isolated rural site in the eastern United States [Parrish et al., this issue]. During the daytime hours between 1000 and 1600 CST, the median NO_x mixing ratio was 0.72 ppbv, while the average was 0.86 ppbv with a standard deviation 0.66 ppbv (D. D. Parrish, private communication, 1991).

In addition, Pierotti et al. [1990] suggested that the ratio of MVK to MACR should decrease with decreasing NO_x as the

odd-hydrogen free-radical chemistry shifted away from OH, and the oxidation of isoprene by ozone became the preferred pathway. We were not able to discern such a trend. However, during the present measurements the minimum NO_x mixing ratio was 0.21 ppbv which is substantially larger than the 0.05 ppbv NO_x mixing ratio alluded to by Pierotti et al. [1990] as representative of very clean air sampled during their measurements.

5. Summary

The mixing ratios of the carbonyls, methyl vinyl ketone (MVK) and methacrolein (MACR), other photochemically active trace constituents, and meteorological parameters have been measured at a rural site in Alabama during the summer of 1990. These results indicate that the carbonyls of interest are principally formed by the photooxidation of isoprene. These conclusions have been corroborated by a simple one-dimensional photochemical model simulation carried out for this site. This simulation, which used accepted rate constants for key chemical reactions and reasonable assumptions concerning emission rates for isoprene from the forest surrounding the site, was able to reproduce the observed daytime ratio of the concentrations of isoprene to those of MVK and MACR and the diurnal variations that were observed for the ratio of MVK to MACR. In accord with the other investigations of these compounds at nonurban locations [Pierotti et al., 1990; Martin et al., 1991] we find that the carbonyls constitute a significant fraction of the volatile organic compounds present in the rural atmosphere and their sources and chemistry must be incorporated into our efforts to understand the air quality issues alluded to in the introduction.

Acknowledgments: SAM would like to thank James Elkins for use of balances required to make gravimetric standards, and Robert Barkley and James Roberts for useful discussions. This work was performed while SAM held a National Research Council-NOAA Research Associateship. This research was supported by the National Oceanic and Atmospheric Administration as a part of the National Acid Precipitation Assessment Program. This research was carried out in collaboration with the Southern Oxidants Study.

References

- Andreae, M. O., R. W. Talbot, T. W. Andreae, and R. C. Harriss, Formic and acetic acid over the central Amazon region, Brazil, 1, Dry season, *J. Geophys. Res.*, **93**, 1616-1624, 1988.
- Atkinson, R., Gas-phase tropospheric chemistry of organic compounds, *Atmos. Environ.*, **24(A)**, 1-41, 1990.
- Atkinson, R., A. M. Winer, and J. N. Pitts, Jr., Rate constants for the gas phase reactions of O₃ with the natural hydrocarbons isoprene and α - and β -pinene, *Atmos. Environ.*, **16**, 1017-1020, 1982.
- Blackadar, A. K., High resolution models of the planetary boundary layer, *Adv. Environ. Sci. Eng.*, **1**, 50-85, 1979.
- Calvert J. G., and W. R. Stockwell, Mechanism and rates of the gas-phase oxidations of sulfur dioxide and nitrogen oxides in the atmosphere, in SO₂, NO, and NO₂, in *Oxidation Mechanisms: Atmospheric Considerations*, edited by J. G. Calvert, Butterworth, Stoneham, Mass., 1984.
- Chameides, W. L., R. W. Lindsay, J. Richardson, and C. S., Kiang, The role of biogenic hydrocarbons in urban photochemical smog: Atlanta as a case study, *Science*, **241**, 1473-1475, 1988.
- Fehsenfeld, F. C., et al., Emissions of volatile organic compounds from vegetation and the implications for atmospheric chemistry, *Global Biogeochem. Cycles*, in press, 1992.
- Gardner, E. P., P. D. Sperry, and J. G. Calvert, Photodecomposition of acrolein in O₂-N₂ mixtures, *J. Phys. Chem.*, **91**, 1922-1930, 1987.
- Goldan, P. D., W. C. Kuster, and D. L. Albritton, A dynamic dilution system for the production of sub-ppb concentrations of reactive and labile species, *Atmos. Environ.*, **20**, 1203-1209, 1986.
- Goldan, P. D., W. C. Kuster, S. A. Montzka, and F. C. Fehsenfeld, Atmospheric hydrocarbons in a rural Alabama pine forest, *Eos Trans. AGU*, **71**, 1228, 1990.
- Gu, C., C. Rynard, D. Hendry, and T. Mill, Hydroxyl radical oxidation of isoprene, *Environ. Sci. Technol.*, **19**, 151-155, 1985.
- Jacob, D. J., and S. C. Wofsy, Photochemistry of biogenic emissions over the Amazon forest, *J. Geophys. Res.*, **93**, 1477-1486, 1988.
- Jacob, D. J., and S. C. Wofsy, Budgets of reactive nitrogen, hydrocarbons, and ozone over the Amazon forest during the wet season, *J. Geophys. Res.*, **95**, 16,737-16,754, 1990.
- Jonsson, A., and S. Berg, Determination of low molecular weight oxygenated hydrocarbons in ambient air by cryogradient sampling and two-dimensional gas chromatography, *J. Chromatogr.*, **279**, 307-322, 1983.
- Jonsson, A., K. A. Persson, and V. Grigoriadis, Measurements of some low molecular weight oxygenated, aromatic, and chlorinated hydrocarbons in ambient air and in vehicle emissions, *Environ. Int.*, **11**, 383-392, 1985.
- Kamens, R. M., M. W. Gery, H. J. F. Jeffries, M. Jackson, and E. I. Cole, Ozone--isoprene reactions: Product formation and aerosol potential, *Int. J. Chem. Kinet.*, **14**, 955-975, 1982.
- Keene, W. C., and J. N. Galloway, Organic acidity in precipitation of North America, *Atmos. Environ.*, **18**, 2491-2497, 1984.
- Kleindienst, T. E., G. W. Harris, J. N. Pitts, Jr., Rates and temperature dependences of the reaction of OH with isoprene, its oxidation products, and selected terpenes, *Environ. Sci. Technol.*, **16**, 844-846, 1982.
- Kuster, W. C., P. D. Goldan, S. A. Montzka, and F. C. Fehsenfeld, Hydrocarbon and oxygenated hydrocarbon sample acquisition techniques used at ROSE I, *Eos Trans. AGU*, **71**, 1228, 1990.
- Lamb, B., A. Guenther, D. Gay, and H. Westberg, A national inventory of biogenic hydrocarbon emissions, *Atmos. Environ.*, **21**, 1695-1705, 1987.
- Lloyd, A. C., R. Atkinson, F. W. Lurmann, and B. Nitta, Modeling potential ozone impacts from natural hydrocarbons, I, Development and testing of a chemical mechanism for the NO_x-air photooxidations of isoprene and α -pinene under ambient conditions, *Atmos. Environ.*, **17**, 1931-1950, 1983.
- Martin, R. S., H. Westberg, E. Allwine, L. Ashman, J. C. Farmer, and B. Lamb, Measurement of isoprene and its atmospheric oxidation products in a Central Pennsylvania deciduous forest, *J. Atmos. Chem.*, **13**, 1-32, 1991.
- Meyrahn, H., J. Pauly, W. Schneider, and P. Warneck, Quantum yields for the photodissociation of acetone in air and an estimate for the life time of acetone in the lower troposphere, *J. Atmos. Chem.*, **4**, 277-291, 1986.
- Ohta, T., Rate constants for the reactions of diolefins with OH radicals in the gas phase, Estimate of the rate constants from those for monoolefins, *J. Phys. Chem.*, **87**, 1209-1213, 1983.
- Parrish, D. D., et al., The total reactive oxidized nitrogen levels and the partitioning between the individual species at six rural sites in eastern North America, *J. Geophys. Res.*, this issue.
- Pierotti, D., Analysis of trace oxygenated hydrocarbons in the environment, *J. Atmos. Chem.*, **10**, 373-382, 1990.
- Pierotti, D., S. C. Wofsy, D. Jacob, and R. A. Rasmussen, Isoprene and its oxidation products: Methacrolein and methyl vinyl ketone, *J. Geophys. Res.*, **95**, 1871-1881, 1990.
- Placet, M., R. E. Battye, F. C. Fehsenfeld, and G. W. Bassett, Emissions involved in acidic deposition processes,

- State-of-Science/Techn. Rep. 1, National Acid Precipitation Assessment Program, NASA, Washington, D.C., 1990.
- Rasmussen, R. A., and M. A. K. Khalil, Isoprene over the Amazon basin, J. Geophys. Res., **93**, 1417-1421, 1988.
- Rhoderick, G. C., and W. L. Zielinski, Jr., Preparation of accurate multicomponent gas standards of volatile toxic organic compounds in the low-parts-per-billion range, Anal. Chem., **60**, 2454-2460, 1988.
- Roberts, J. M., F. C. Fehsenfeld, D. L. Albritton, and R. E. Sievers, Sampling and analysis of monoterpene hydrocarbons in the atmosphere with Tenax gas chromatographic porous polymer, in Identification and Analysis of Organic Pollutants in Air, edited by L.H. Keith, Butterworth, pp. 371-387, Stoneham, Mass., 1984a.
- Roberts, J. M., F. C. Fehsenfeld, S. C. Liu, M. J. Bollinger, C. Hahn, D. L. Albritton, and R. E. Sievers, Measurements of aromatic hydrocarbon ratios and NO_x concentrations in the rural troposphere: Observation of air mass photochemical aging and NO_x removal, Atmos. Environ., **18**, 2421-2432, 1984b.
- Roberts, J. M., R. S. Hutte, F. C. Fehsenfeld, D. L. Albritton, and R. E. Sievers, Measurements of anthropogenic hydrocarbon concentration ratios in the rural troposphere: Discrimination between background and urban sources, Atmos. Environ., **19**, 1945-1950, 1985.
- Trainer, M., E. Y. Hsie, S. A. McKeen, R. Tallamraju, D. D. Parrish, F. C. Fehsenfeld, and S. C. Liu, Impact of natural hydrocarbons on hydroxyl and peroxy radicals at a remote site, J. Geophys. Res., **92**, 11,879-11,894, 1987.
- Trainer, M., et al., Observations and modeling of the reactive nitrogen photochemistry at a rural site, J. Geophys. Res., **96**, 3045-3063, 1991.
- Tuazon, E. C., and R. Atkinson, A product study of the gas-phase reaction of isoprene with the OH radical in the presence of NO_x, Int. J. Chem. Kinet., **22**, 1221-1236, 1990.
- Zhang, D., and R. A. Anthes, A high-resolution model of the planetary boundary layer-sensitivity tests and comparisons with SESAME-79 data, J. Appl. Meteorol., **21**, 1594-1609, 1982.
- Zimmerman, P. R., R. B. Chatfield, J. Fishman, P. J. Crutzen, and P. L. Hanst, Estimates on the production of CO and H₂ from the oxidation of hydrocarbon emissions from vegetation, Geophys. Res. Lett., **5**, 679-682, 1978.
- Zimmerman, P. R., J. P. Greenberg, and C. E. Westberg, Measurements of atmospheric hydrocarbons and biogenic emission fluxes in the Amazon boundary layer, J. Geophys. Res., **93**, 1407-1416, 1988.
-
- F. C. Fehsenfeld, P. D. Goldan, W. C. Kuster, and M. Trainer, Aeronomy Laboratory, National Oceanic and Atmospheric Administration, 325 Broadway, Boulder, CO 80303.
- S. A. Montzka, Climate Monitoring and Diagnostics Laboratory, National Oceanic and Atmospheric Administration, 325 Broadway, Boulder, CO 80303.

(Received January 15, 1992;
revised October 6, 1992;
accepted October 6, 1992.)