

Helicopter Adaptive Control with Parameter Estimation Based on Feedback Linearization

A. R. Nemati, M. Haddad Zarif, and M. M. Fateh

II. SYSTEM DESCRIPTION

A. Modeling of Helicopter

Dynamics of the twin rotor system, are derived in [5] for the ETH helicopter process using Euler-Lagrange approach. A schematic of the helicopter process configuration is shown in Fig. 1. The helicopter consists of a vertical axle (A), on which a lever arm (L) is connected by a cylindrical joint. The helicopter has two degrees of freedom: the rotation of the vertical axle (angle) with respect to the fixed ground, and the pivoting of the lever arm (angle) with respect to the vertical axle. Two rotors are mounted on the lever arm: R_1 , and R_2 , with the resultant aerodynamic forces giving rise to moments in the B and q directions, respectively. The voltages u_1 and u_2 to the rotor motors are the inputs of the system.

The dynamics for ETH helicopter model are:

$$\frac{d}{dt} \phi = \dot{\phi} \quad (1)$$

$$\frac{d}{dt} \dot{\phi} = L_1^{-1} [L_2 + L_3 + L_4] \quad (2)$$

$$\frac{d}{dt} \theta = \dot{\theta} \quad (3)$$

$$\frac{d}{dt} \dot{\theta} = L_5^{-1} [L_6 + L_7 + L_8] \quad (4)$$

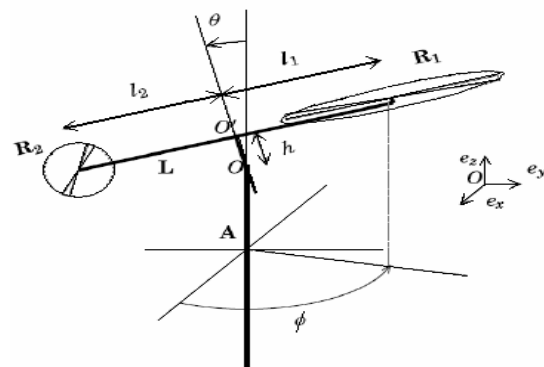

Fig. 1 Helicopter process configuration

Abstract—This paper presents an adaptive feedback linearization approach to derive helicopter. Ideal feedback linearization is defined for the cases when the system model is known. Adaptive feedback linearization is employed to get asymptotically exact cancellation for the inherent uncertainty in the knowledge of the given parameters of system. The control algorithm is implemented using the feedback linearization technique and adaptive method. The controller parameters are unknown where an adaptive control law aims to drive them towards their ideal values for providing perfect model matching between the reference model and the closed-loop plant model. The converged parameters of controller would then provide good estimates for the unknown plant parameters.

Keywords—Adaptive control, Helicopter, Feedback linearization, Nonlinear control.

I. INTRODUCTION

CONTROL of nonlinear systems using the state feedback linearization method, or the exact linearization method, has received a great deal of attention in the nonlinear control theory [1-3]. Feedback linearization consists of finding a feedback control law and a state variable transformation (diffeomorphism), such that the closed-loop system model becomes linear in a new coordinate system. The applicability of feedback linearization, however, is somewhat limited due to the requirement of detailed knowledge of the system model. Moreover, along with stringent constraints that must be satisfied by the original nonlinear system in order to synthesize the nonlinear controller. In our study, to facilitate the use of the feedback linearization without a prior knowledge of the system nonlinearities, the twin rotor helicopter [4] is used in modeling the unknown nonlinear system. Since helicopters are difficult types of aircraft to control. Generally they exhibit complex behaviors and their dynamics are in general nonlinear, time varying and may be highly uncertain.

A. R. Nemati is with the Electrical and Robotic Department, Shahrood University of Technology, Iran (e-mail: nem_alireza@yahoo.ca).

M. H. Zarif is with the Electrical and Robotic Department, Shahrood University of Technology, Iran (e-mail: mhzarif@shahroodut.ac.ir).

M. M. Fateh is with the Electrical and Robotic Department, Shahrood University of Technology, Iran (e-mail: mmfateh@shahroodut.ac.ir).

$$\frac{d}{dt} \omega_1 = -\frac{1}{T_1} \omega_1 + \frac{1}{k_1 T_1} u_1 \quad (5)$$

$$\frac{d}{dt} \omega_2 = -\frac{1}{T_2} \omega_2 + \frac{1}{k_2 T_2} u_2 \quad (6)$$

$$-14.98 \cos(x_3) - x_2^2 \cos(x_3) \sin(x_3) \quad (10)$$

$$\dot{x}_5 = -0.9091x_5 + 90.9091u_1 \quad (11)$$

$$\dot{x}_6 = -3.03x_6 + 218u_2 \quad (12)$$

where:

$$L_1 = \cos^2 \theta J_L - 2h \cos \theta m l_c + h^2 \sin^2 \theta m + J_A$$

$$L_2 = 2 \cos \theta \sin \theta \dot{\phi} J_L - 2h(\sin^2 \theta - \cos^2 \theta) \dot{\phi} \dot{\theta} m l_c$$

$$L_3 = 2h^2 \sin \theta \cos \theta \dot{\phi} \dot{\theta} m$$

$$L_4 = D_1 \omega_1 |\omega_1| \cos \theta + l_2 \cos \theta C_2 \omega_2 |\omega_2|$$

$$L_5 = J_L h^2 m$$

$$L_6 = -\cos \theta \sin \theta \dot{\phi}^2 J_L - h(-\sin^2 \theta + \cos^2 \theta) \dot{\phi}^2 m l_c$$

$$L_7 = -g \cos \theta m l_c + h^2 \sin \theta \cos \theta \dot{\phi}^2 m$$

$$L_8 = mgh \sin \theta + l_1 C_1 \omega_1 |\omega_1| + D_2 \omega_2 |\omega_2|$$

where D_1 , D_2 are aerodynamic torque coefficient, C_1 , C_2 are Drag force coefficient, k_1, k_2 are rotors constant, T_1 , T_2 are rotors time constants and u_1 , u_2 are rotors input voltages.

B. Simplification of the Model

The values of different parameters are given in [6]. Due to complexity of nonlinear terms, exact state feedback linearization of (1) to (6) is not possible. Therefore, the model is simplified by reducing the height of the pivot point to zero i.e. $h=0$.

After inserting values of various parameters, the resulting dynamics of twin rotor system are:

$$\dot{x}_1 = x_2 \quad (7)$$

$$\begin{aligned} \dot{x}_2 = & 1.16 \times 10^{-5} x_5^2 \sec(x_3) + 1.1 \times 10^{-4} x_6^2 \sec(x_3) \\ & + 2x_2 x_4 \tan(x_3) \end{aligned} \quad (8)$$

$$\dot{x}_3 = x_4 \quad (9)$$

$$\dot{x}_4 = 1.998 \times 10^{-4} x_5^2 + 7.05 \times 10^{-6} x_6^2$$

III. FEEDBACK LINEARIZING CONTROL OF HELICOPTER

A. Feedback Linearizing Control

A brief review of nonlinear control using feedback linearization [7] is presented. Without loss of generality, the multi-input, multi-output nonlinear system with m-input, m-output is considered.

$$\begin{aligned} \dot{x} &= f(x) + g_1(x)u_1 + \dots + g_p(x)u_p \\ y &= h_1(x) \\ &\vdots \\ y_p &= h_p(x) \end{aligned} \quad (13)$$

where $x \in R^n$ is state vector, $u \in R^p$ represents control inputs, $y \in R^p$ stands for outputs, f and g are smooth vector fields, and h is a smooth scalar function. Now, differentiate the outputs y_j with respect to time to get

$$\dot{y}_j = L_f h_j + \sum_{i=1}^p (L_{g_i} h_j) u_i \quad (14)$$

In (14) $L_f h_j$ stands for the Lie derivative of h_j with respect to f , similarly $L_{g_i} h_j$. Note that if each of the $(L_{g_i} h_j)(x) \equiv 0$, then the input do not appear in (14). Define γ_j to be the smallest integer such that at least one of the inputs appears in $y_j^{(\gamma_j)}$, i.e.,

$$y_j^{(\gamma_j)} = L_f^{\gamma_j} h_j + \sum_{i=1}^p L_{g_i} (L_f^{\gamma_j-1} h_j) u_i \quad (15)$$

With at least one of the $L_{g_i} (L_f^{\gamma_j-1} h_j) \neq 0 \quad \forall x$. Define the $p \times p$ matrix $A(x)$ as

$$A(x) = \begin{bmatrix} L_{g_1} (L_f^{\gamma_1-1} h_1) & \dots & L_{g_p} (L_f^{\gamma_1-1} h_1) \\ \vdots & \ddots & \vdots \\ L_{g_1} (L_f^{\gamma_p-1} h_p) & \dots & L_{g_p} (L_f^{\gamma_p-1} h_p) \end{bmatrix} \quad (16)$$

Then equation (15) may be written as

$$\begin{bmatrix} y_1^{(\gamma_1)} \\ \vdots \\ y_p^{(\gamma_p)} \end{bmatrix} = \begin{bmatrix} L_f^{\gamma_1} h_1 \\ \vdots \\ L_f^{\gamma_p} h_p \end{bmatrix} + A(x) \begin{bmatrix} u_1 \\ \vdots \\ u_p \end{bmatrix} \quad (17)$$

If $A(x) \in R^{p \times p}$ is bounded away from singularity, the state feedback control law

$$u = -A(x)^{-1} \begin{bmatrix} L_f^{\gamma_1} h_1 \\ \vdots \\ L_f^{\gamma_p} h_p \end{bmatrix} + A(x)^{-1} v \quad (18)$$

Yields the closed-loop decoupled, linear system

$$\begin{bmatrix} y_1^{(\gamma_1)} \\ \vdots \\ y_p^{(\gamma_p)} \end{bmatrix} = \begin{bmatrix} v_1 \\ \vdots \\ v_p \end{bmatrix} \quad (19)$$

where $[v_1 \ \dots \ v_p]^T$ are the new sets of inputs defined by the designer.

Once linearization has been achieved, any further control objective such as model latching, pole placement, tracking may be easily met. If $A(x)$ define in (16) is singular, linearization may still be achieved using dynamic state feedback. The development may be followed using integrators before some of the inputs; exact conditions under linearization may be achieved by given dynamic state feedback [8].

B. Nonlinear Control Design for Helicopter

We can divide the dynamics in two subsystems. Subsystem 1 contains equations (7) to (10) whereas subsystem 2 consists of (11) and (12). Subsystem 1 represents the position of twin rotor system whereas subsystem 2 represents the velocity of main and tail rotor. So,

$$f(x) = \begin{bmatrix} x_2 \\ 2x_2x_4 \tan(x_3) \\ x_4 \\ -14.98 \cos(x_3) - x_2^2 \cos x_3 \sin(x_3) \end{bmatrix}$$

$$g(x) = \begin{bmatrix} 0 & 0 \\ 0.116 \sec(x_3) & 1.1 \sec(x_3) \\ 0 & 0 \\ 1.998 & 0.0705 \end{bmatrix}$$

$$h(x) = [x_1 \ x_3]^T$$

The feedback linearization law is

$$u = -A^{-1}(x)b(x) + A(x)^{-1}v$$

where $A(x)$ with $p = 2$ is given by

$$A(x) = \begin{bmatrix} 0.116 \sec(x_3) & 1.1 \sec(x_3) \\ 1.998 & 0.0705 \end{bmatrix} \quad (20)$$

and

$$b(x) = \begin{bmatrix} 2x_2x_4 \tan(x_3) \\ -14.98 \cos(x_3) - x_2^2 \cos(x_3) \sin(x_3) \end{bmatrix} \quad (21)$$

Thus,

$$\begin{bmatrix} u_1 \\ u_2 \end{bmatrix} = A^{-1}(x) \left[-b(x) + \begin{bmatrix} v_1 \\ v_2 \end{bmatrix} \right]$$

For tracking of outputs the control inputs v_1 and v_2 are selected as:

$$\begin{bmatrix} v_1 \\ v_2 \end{bmatrix} = \begin{bmatrix} \ddot{y}_{d1} - K_{11}\dot{e}_1 - K_{12}e_1 \\ \ddot{y}_{d2} - K_{21}\dot{e}_2 - K_{22}e_2 \end{bmatrix} \quad (22)$$

e_1 and e_2 are errors defined as: $e_1 = y_1 - y_{d1}$ and $e_2 = y_2 - y_{d2}$, where y_{d1}, y_{d2} are desired outputs. From (22), the error dynamics are given by:

$$\begin{aligned} \ddot{e}_1 + K_{11}\dot{e}_1 + K_{12}e_1 &= 0 \\ \ddot{e}_2 + K_{21}\dot{e}_2 + K_{22}e_2 &= 0 \end{aligned} \quad (23)$$

IV. ADAPTIVE FEEDBACK LINEARIZATION SCHEME

In practical implementations of exactly linearization control laws, the chief drawback is that they are based on exact cancellation of nonlinear terms. If there is any uncertainty in the knowledge of the nonlinear functions f and g , the cancellation is not exact and the resulting input-output equation is not linear. we use the parameter adaptive control to get asymptotically exact cancellation.

A. Adaptive Control of SISO Systems

Consider a SISO system with $L_g h(x) \neq 0$. Further, let $f(x)$ and $g(x)$ have the form

$$f(x) = \sum_{i=1}^{n_1} \theta_i^1 f_i(x) \quad (24)$$

$$g(x) = \sum_{j=1}^{n_2} \theta_j^2 g_j(x) \quad (25)$$

with $\theta_i^1, i=1, \dots, n_1; \theta_j^2, j=1, \dots, n_2$ unknown parameters and the $f_i(x), g_i(x)$ known functions. Consequently, the control law u is replaced by

$$u = \frac{1}{\hat{L}_g h} (-\hat{L}_f h + v) \quad (26)$$

and $\hat{L}_g h, \hat{L}_f h$ are the estimates of $L_g h, L_f h$, respectively

$$\hat{L}_f h = \sum_{i=1}^{n_1} \hat{\theta}_i^1(t) L_{f_i} h \quad (27)$$

$$\hat{L}_g h = \sum_{i=2}^{n_2} \hat{\theta}_j^2(t) L_{g_j} h \quad (28)$$

$(\theta^{1T}, \theta^{2T})^T$, $\hat{\theta} \in R^{n_1+n_2}$ the parameter estimate, and $\phi = \theta - \hat{\theta}$ the parameter error, then substituting (26) into (18) and after some calculation yields

$$\dot{y} = v + \phi^{1T} w_1 + \phi_{2T} w_2 \quad (29)$$

with

$$w_1 \in R^{n_1} := \begin{bmatrix} L_{f_1} h \\ \vdots \\ L_{f_{n_1}} h \end{bmatrix} \quad (30)$$

$$w_2 \in R^{n_2} := \begin{bmatrix} L_{g_1} h \\ \vdots \\ L_{g_{n_2}} h \end{bmatrix} \frac{(-\hat{L}_f h + v)}{\hat{L}_g h} \quad (31)$$

The control law used for tracking is

$$v = \dot{y}_d + K(y - y_d)$$

The following error equation is obtained relating $y - y_d = e$ to the parameter error $\phi = (\phi^{1T} + \phi^{2T})^T$.

$$\dot{e} + Ke = \phi^T w \quad (32)$$

Along with the update law

$$\dot{\phi} = -ew \quad (33)$$

$w \in R^{n_1+n_2}$ is define to be the concatenation of w_1, w_2 . [9]

B. Adaptive Control of MIMO Systems

From the preceding discussion it is easy to see how the feedback control law for square system can be adaptive by replacing the control law of (18) by

$$u = -\hat{A}^{-1}(x) \times \hat{b}(x) + \hat{A}(x)^{-1} \times v \quad (34)$$

Note that if $\hat{A}(x)$ is invertible, then the feedback linearization control law is also the decoupling control law. Thus, if $\hat{A}(x)$ and $\hat{b}(x)$ depend linearly on certain unknown parameters, the scheme of the previous section can be readily adapted.

V. SIMULATION RESULTS FOR HELICOPTER MODEL

Simulation results for both arrangements are shown. The performance of the adaptive feedback linearization controller is evaluated and compared with exact feedback linearization by computer simulation.

A. Feedback Linearization with Known Parameter

Fig. 2 shows the response of system using feedback linearization with known parameter. The Error between actual and desired outputs goes to zero as shown in Fig. 3. Fig. 4 shows that all states of system are bounded.

In this part of simulation we will see that when we have uncertain parameter in our system, feedback linearization is not due to get exact cancellation for the uncertainty of the given system parameters, and we have an error in our outputs. This fact is shown by Fig. 5 and Fig. 6.

B. Adaptive Feedback Linearization with Unknown Parameter

In the last part of simulation we show that adaptive feedback linearization can get asymptotically exact cancellation for the inherent uncertainty in the knowledge of the given system parameters. The responses are shown by Fig. 7 and Fig. 8.

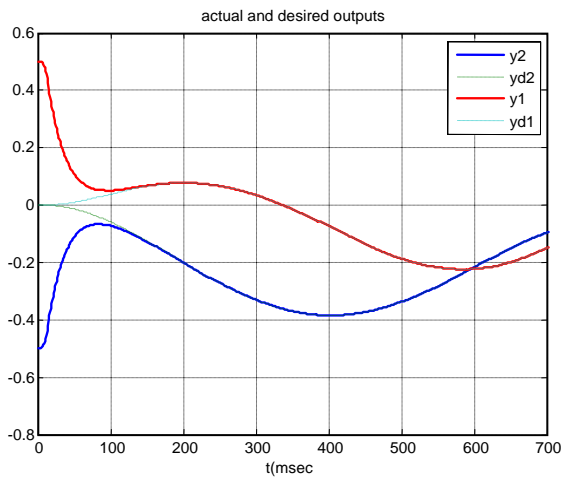

Fig. 2 Actual and desired outputs (known parameter control law)

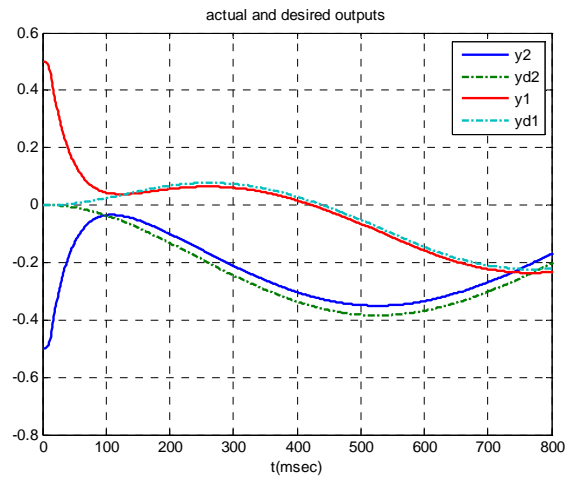

Fig. 5 Actual and desired outputs (unknown parameter control law)

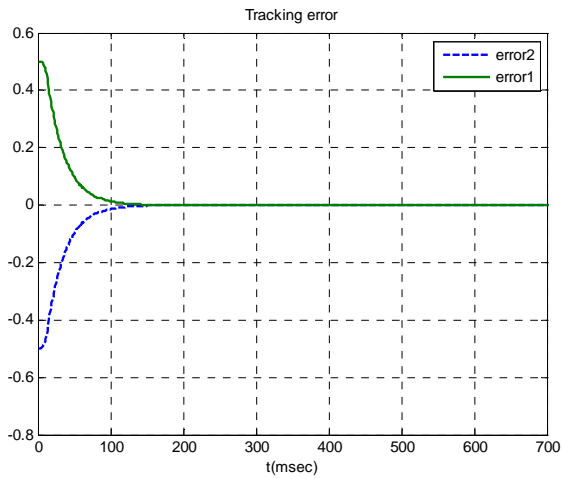

Fig. 3 Tracking error (known parameter control law)

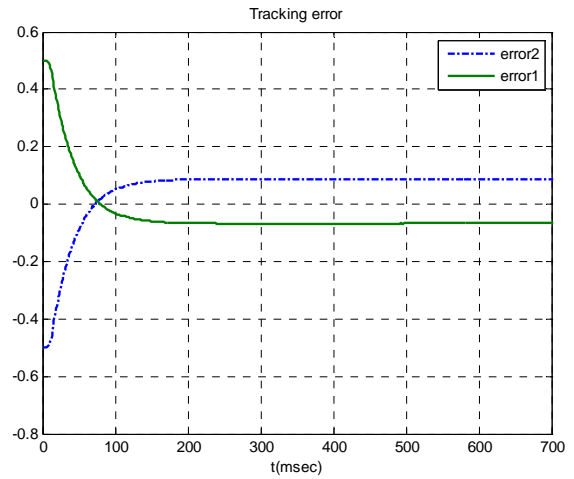

Fig. 6 Tracking error (unknown parameter control law)

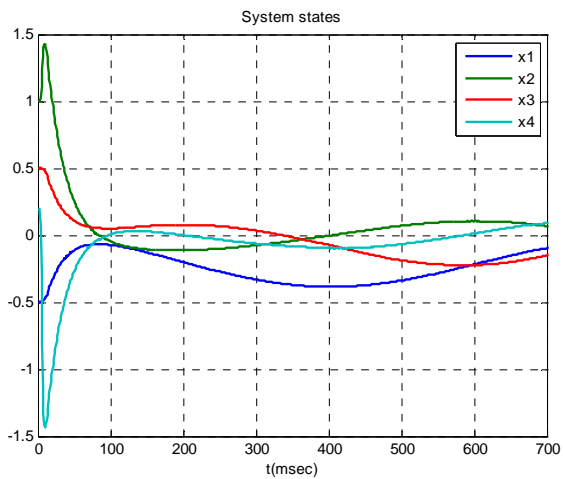

Fig. 4 System states (known parameter control law)

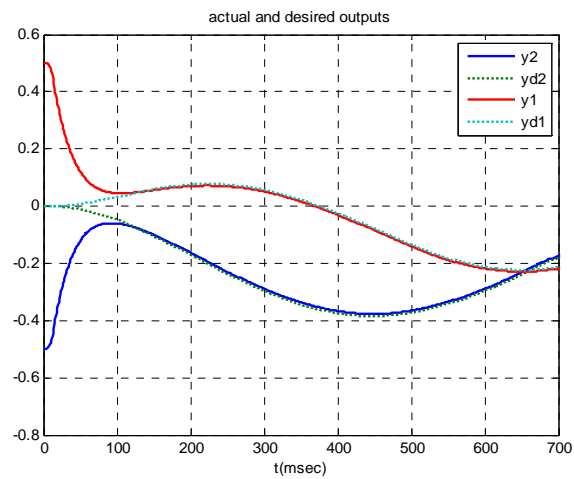

Fig. 7 Actual and desired outputs (adaptive feedback linearization)

International Science Index, Mechanical and Mechatronics Engineering Vol:1, No:5, 2007 waset.org/Publication/9009

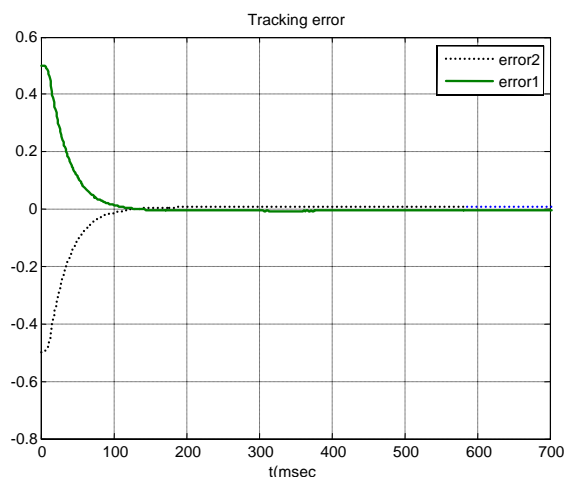

Fig. 8 Tracking error (adaptive feedback linearization)

VI. CONCLUSION

In this paper, we have developed feedback linearization strategy using the adaptive control of nonlinear systems with unknown parameter. In this design, the feedback linearization technique is used in an adaptive manner. Computer simulation on a nonlinear system with unknown parameters was performed, illustrating the effectiveness of the proposed feedback linearization-based adaptive control method.

From these results, it is concluded that the online adaptive feedback linearization suggested in this paper is very effective in dealing with performance degradation problem of the trajectory following caused by insufficient information of system parameters.

REFERENCES

- [1] Zhao Lu and Leang-San Shieh, "Adaptive feedback linearization control of chaotic systems". Information Sciences 176, pp.2337–2354, 2006.
- [2] Qian Wang, Robert F. Stengel, "Robust control of nonlinear systems with parametric uncertainty," Automatica 38., pp. 1591 – 1599, 2002.
- [3] Himani Jain and N. Ananthkrishnan, "Parameter estimation of unstable, limit cycling systems using adaptive feedback linearization: example of delta wing roll dynamics," Journal of Sound and Vibration 287, pp. 939–960, 2005.
- [4] M. Sacki, J. Imura, and Y. Wada; "Flight control design of twin rotor helicopter model by 2 step exact linearization", Proc. of IEEE Int. Conf. on Control Applications, Vol.1, 146/151, 1999.
- [5] G. Mustafa and N. Iqbal , "Design for a Twin Rotor Helicopter Model Via Exact State Feedback", IEEE 2004.
- [6] Magnus Gafvert, "Modeling of the ETH Helicopter Process", Department of Automatic Control Lund Institute of Technology, November 2001.
- [7] S. S Sastry and A. Isidori, "Adaptive control of linearizable systems, " IEEE Trans, Automat. Contr., vol. 34, pp. 1123-1131, Nov. 1989.
- [8] J. Descusse and C.H. Moog "Decoupling with dynamic compensation for strongly invertible affine nonlinear systems," Int. J Contr., no 42, pp. 1387-1398, 1985.
- [9] M. French and E Rogers, "Approximate Paramaterisations for Adaptive Feedback Linearisation," Conference on Decision & Control San Diego, California USA December 1997.