

# Control of a DC Servomotor Using Fuzzy Logic Sliding mode Model Following Controller

Phongsak Phakamach

**Abstract**—A DC servomotor position control system using a Fuzzy Logic Sliding mode Model Following Control or FLSMFC approach is presented. The FLSMFC structure consists of an integrator and variable structure system. The integral control is introduced into it in order to eliminated steady state error due to step and ramp command inputs and improve control precision, while the fuzzy control would maintain the insensitivity to parameter variation and disturbances. The FLSMFC strategy is implemented and applied to a position control of a DC servomotor drives. Experimental results indicated that FLSMFC system performance with respect to the sensitivity to parameter variations is greatly reduced. Also, excellent control effects and avoids the chattering phenomenon.

**Keywords**—Sliding mode Model Following Control, Fuzzy Logic, DC Servomotor.

## I. INTRODUCTION

RECENTLY, advancements in magnetic materials, semiconductor power devices and control theory have made the permanent magnet motor servo drive play an important role in motion control applications [1]. In the servo applications, significant parameter variations arise from often unknown loads; for example, in machine tool drives and robotics. The proposed scheme for DC motor position servo control is shown in Fig. 1. The current control loop is a current controlled pulse width modulation voltage source inverter, which is widely applied in high performance servo drivers. The outer loop controller is designed to achieve a fast and accurate servo tracking response under load disturbance and plant parameter variations. The dynamics characteristic of such systems are very complex and highly nonlinear, a conventional linear controller may not assure satisfactory requirements.

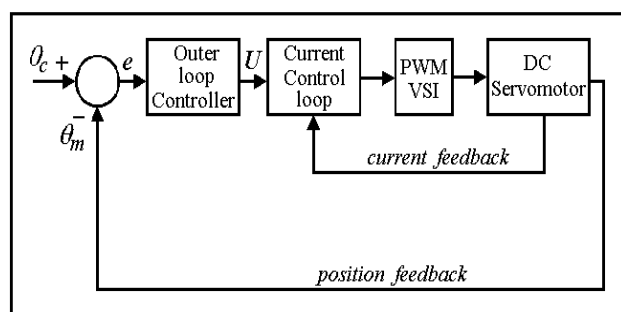

Fig. 1 The DC servomotor control structure.

Phongsak Phakamach: He is currently lecturer of electronics engineering department, faculty of engineering, North Eastern University, 199/19 Mittrparb Rd., Nai-Muang Muang Khon Kaen Thailand 40000. (p\_phakamach@hotmail.com)

Variable Structure Control (VSC) or Sliding Mode Control (SMC) reduce the system dynamics to the motion along the sliding surface. The important feature in VSC is what is termed sliding mode. The VSC approach possesses other salient advantages such as high speed of response, good transient performance and no need for precise knowledge of the controlled plant. Although the conventional VSC approach has been applied successfully in many applications[2-5], it cannot perform well in servo applications where the system is designed to track a command input. In order to improve tracking performance, the Integral Variable Structure Model Following Control or IVSMFC approach, presented in [6-7]. The IVSMFC approach can eliminate the steady tracking error due to a step command input. However, IVSMFC yields the error when the system has to follow a changing command input, e.g., a ramp input. The Modified Integral Variable Structure Control or MIVSC approach, proposed in [8-9], uses a double integral action to solve this problem. Although, the MIVSC can give a better tracking performance than the IVSMFC does at steady state, its performance during transient period needs to be improved. However, the main problem of VSC, IVSMFC and MIVSC is the chattering phenomenon restricts its application.

Fuzzy control is a practical control method which imitates human being fuzzy reasoning and decision making processes. Fuzzy logic control is derived from the fuzzy logic and fuzzy set theory that were introduced in 1965 by Professor Lotfi A. Zadeh of the University of California at Berkeley. Fuzzy logic control can be applied in many disciplines such as economics, data analysis, engineering and other areas that involve a high level of uncertainty, complexity or nonlinearity. In engineering, engineers can use the fundamentals of fuzzy logic and fuzzy set theory to create the pattern and the rules, then design the fuzzy controllers. Finally, the output response of many systems can be improved by using a fuzzy controller [8-9]. The method is applicable to conduct robustness control over target for which a mode is hard to be established. The final program form of the method is simple and easy to achieve. Therefore, combining fuzzy control with the VSC would maintain the insensitivity of sliding mode control to parameter perturbation and external disturbances while in the mean time effectively eliminate the chattering phenomenon.

This paper presents the design and implementation of a DC servomotor position control systems using the FLSMFC approach. This approach, which is the extension of IVSMFC approach, incorporates a feedforward path and fuzzy control to improve the dynamics response for command tracking and strong robustness. An experimental prototype system consisting of a digital signal processor from Texas Instrument is constructed. Experimental results are presented for demonstrating the potential of the proposed scheme and the tracking performance can be remarkably improved.

## II. DESIGN OF FLSMFC SYSTEM

The structure of FLSMFC is shown in Fig. 2 can be described by the following equation of state

$$\dot{x}_i = x_{i+1}, i=1, \dots, n-1, \dot{x}_n = -\sum_{i=1}^n a_i x_i + bU - f(t) \quad \dot{x}_0 = (r - x_1) \quad (1)$$

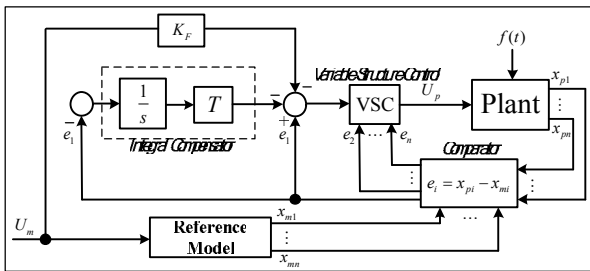

Fig. 2. The structure of FLSMFC system.

The switching function,  $\sigma$  is given by

$$\sigma = c_1(x_1 - Tx_0 - rK_F) + \sum_{i=2}^n c_i x_i \quad (2)$$

where  $C_i > 0 = \text{constant}$ ,  $C_n = 1$  and  $T = \text{integral time}$ .

The control signal,  $U$  can be determined as follows, from (1) and (2), we have

$$\dot{\sigma} = -c_1 T(r - x_1) + \sum_{i=2}^n c_{i-1} x_i - \sum_{i=1}^n a_i x_i + bU - f(t) \quad (3)$$

Let  $a_i = a_i^0 + \Delta a_i$ ;  $i=1, \dots, n$  and  $b = b^0 + \Delta b$ ;  $b^0 > 0$ ,  $\Delta b > -b^0$ .

The control signal can be separated into

$$U = U_{eq} + U_{fu} \quad (4)$$

This condition results in

$$U_{eq} = \{c_1 T(r - x_1) - \sum_{i=2}^{n-1} c_{i-1} x_i + \sum_{i=1}^{n-1} a_i^0 x_i\} / b^0 \quad (5)$$

The transfer function when the system is on the sliding surface can be shown as

$$H(s) = \frac{X_1(s)}{R(s)} = \frac{\alpha_n}{s^n + \alpha_1 s^{n-1} + \dots + \alpha_{n-1} s + \alpha_n} \quad (6)$$

The transient response of the system can be determined by suitably selecting the poles of the transfer function.

$$\text{Let } s^n + \alpha_1 s^{n-1} + \dots + \alpha_{n-1} s + \alpha_n = 0 \quad (7)$$

be the desired characteristic equation (closed-loop poles), the coefficient  $C_1$  and  $T$  can be obtained by

$$C_{n-1} = \alpha_1, C_1 = \alpha_{n-1} \text{ and } T = \alpha_n / \alpha_{n-1}.$$

## III. DESIGN OF FUZZY LOGIC CONTROLLER

By the definition

$$U_{fu} = k_1(x_1 - Tx_0 - rK_F) + \sum_{i=2}^n k_i x_i + k_{n+1} + K[\Delta k_1(x_1 - Tx_0 - rK_F)] + \sum_{i=2}^n k_i x_i \quad (8)$$

$U_{fu}$  is required to guarantee the existence of the sliding mode under the plant parameter variations in  $\Delta a_i$  and  $\Delta b$  and the disturbances  $f(t)$ . Among them,

$$k_i = \begin{cases} \alpha_i & \text{if } (x_1 - Tx_0 - rK_F)\sigma > 0 \\ \beta_i & \text{if } (x_1 - Tx_0 - rK_F)\sigma < 0 \end{cases}, k_i = \begin{cases} \alpha_i & \text{if } x_i \sigma > 0 \\ \beta_i & \text{if } x_i \sigma < 0 \end{cases}, i = 2, \dots, n$$

$$\text{and } k_{n+1} = \begin{cases} \alpha_{n+1} & \text{if } \sigma > 0 \\ \beta_{n+1} & \text{if } \sigma < 0 \end{cases}$$

According to (3), we know

$$\dot{\sigma} = -c_1 T(r - x_1) + \sum_{i=2}^n c_{i-1} x_i - \sum_{i=1}^n a_i x_i + bU - f(t)$$

$$\text{and } U = U_{eq} + k_1 T(r - x_1) - \sum_{i=2}^{n-1} k_i x_i \quad (9)$$

The condition for the existence of a sliding mode is known to be

$$\sigma \dot{\sigma} < 0 \quad (10)$$

In order for (10) to be satisfied, the following conditions must be met,

$$k_i = \begin{cases} \alpha_i & < \text{Inf} [\Delta a_i - a_i^0 \Delta b / b^0 + c_{i-1} \Delta b / b^0] \\ -c_i (c_{n-1} - a_n^0) (1 + \Delta b / b^0) / b & \\ \beta_i & > \text{Sup} [\Delta a_i - a_i^0 \Delta b / b^0 + c_{i-1} \Delta b / b^0] \\ -c_i (c_{n-1} - a_n^0) (1 + \Delta b / b^0) / b & \end{cases} \quad (11a)$$

where  $i = 1, \dots, n-1, c_0 = 0$

$$k_n = \begin{cases} \alpha_n & < \text{Inf} [\Delta a_n + a_n^0 - c_{n-1}] / b \\ \beta_n & > \text{Sup} [\Delta a_n + a_n^0 - c_{n-1}] / b \end{cases}$$

$$\text{and where } k_{n+1} = \begin{cases} \alpha_{n+1} & < \text{Inf} [-N] / b \\ \beta_{n+1} & > \text{Sup} [-N] / b \end{cases} \quad (11b)$$

Now we consider the effect of  $\Delta k_i (i=1, \dots, n)$ ,  $\Delta k_i$  is the function is to eliminate the chattering phenomenon of the control system and find out  $\Delta k_i$  by making use of fuzzy set theory. Firstly take positive constants  $\alpha$  and  $\beta$ , normalize switching function  $\sigma$  and its rate of change against time.

$$\text{Suppose } \sigma_n = \alpha, \sigma \quad (12)$$

$$\sigma_n = \beta, \sigma \quad (13)$$

The input variable of the fuzzy controller is

$$\sigma_n \text{sign}(x_1 - Tx_0 - rK_F), \dot{\sigma}_n \text{sign}(x_1 - Tx_0 - rK_F), \sigma_n \text{sign}(x_i)$$

And  $\dot{\sigma}_n \text{sign}(x_i) (i=2, \dots, n)$ , the output of the controller is  $\Delta k_i$ .

Secondly, define the language value of  $\sigma_n$  and  $\dot{\sigma}_n$  as P, Z, N;  $\Delta k_i$  is language value as PB, PM, PS, ZE, NS, NM, NB; as well as their subordinate functions as in Figs. 3~5:

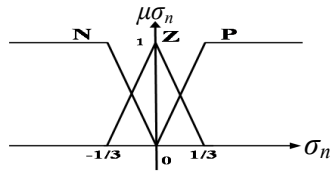

Fig. 3 The subordinate function of  $\sigma_n$ .

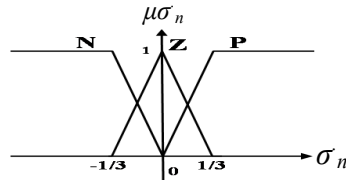

Fig. 4 The subordinate function of  $\dot{\sigma}_n$ .

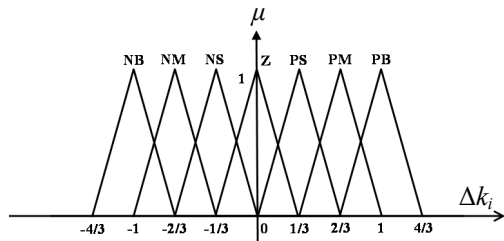

Fig. 5 The subordinate function of  $\Delta k_i$ .

Define the following fuzzy control regularity Table 1.

TABLE 1  
FUZZY CONTROL REGULARITY

	N	Z	P
N	PB	PM	PS
Z	PS	ZE	NS
P	NS	NM	NB

According to the above form, use the fuzzy calculation method introduced in [12] and gravity method to turn fuzzy output into precise control quantity

$$\Delta k_i = \left( \int \Delta k_i \tilde{\mu}_{\Delta k_i} d\Delta k_i \right) / \left( \int \tilde{\mu}_{\Delta k_i} d\Delta k_i \right) \quad (14)$$

when

$$(1) \sigma_n \leq -\frac{1}{3}, \dot{\sigma}_n \leq -\frac{1}{3}; \text{ it is easy to get } \Delta k_i = 1,$$

and when

$$(2) \sigma_n \leq -\frac{1}{3}, -\frac{1}{3} < \dot{\sigma}_n \leq 0; \sigma_n(N), \dot{\sigma}_n(N,Z).$$

The subordinate function of  $\Delta k_i$  (PB, PM) corresponding to is shown in [13].

Thus, points  $P_1$  and  $P_2$ 's abscissa are  $\dot{\sigma}_n + \frac{2}{3}, \dot{\sigma}_n + 1$ ;

$P_3$  and  $P_4$ 's abscissas are  $-\dot{\sigma}_n + \frac{2}{3}, \dot{\sigma}_n + \frac{4}{3}$ ; then

$$\Delta k_i = \frac{-\frac{5}{2}\dot{\sigma}_n^2 - \frac{7}{6}\dot{\sigma}_n + \frac{2}{9}}{-3\dot{\sigma}_n^2 - \dot{\sigma}_n + \frac{1}{3}}.$$

$$\Delta k_i = \left\{ \begin{array}{ll} 1 & \sigma_n \leq \frac{1}{3} \quad \dot{\sigma}_n \leq \frac{1}{3} \\ \frac{-\frac{5}{2}\dot{\sigma}_n^2 - \frac{7}{6}\dot{\sigma}_n + \frac{2}{9}}{-3\dot{\sigma}_n^2 - \dot{\sigma}_n + \frac{1}{3}} & \sigma_n \leq \frac{1}{3} \quad -\frac{1}{3} < \dot{\sigma}_n \leq 0 \\ \frac{-\frac{3}{2}\dot{\sigma}_n^2 + \frac{1}{6}\dot{\sigma}_n + \frac{2}{9}}{-3\dot{\sigma}_n^2 - \dot{\sigma}_n + \frac{1}{3}} & \sigma_n \leq \frac{1}{3} \quad 0 < \dot{\sigma}_n \leq \frac{1}{3} \\ \frac{1}{3} & \sigma_n \leq \frac{1}{3} \quad \dot{\sigma}_n > \frac{1}{3} \\ \frac{-4\dot{\sigma}_n^2 - 2\dot{\sigma}_n + \frac{1}{9}}{-6\dot{\sigma}_n^2 - 2\dot{\sigma}_n + \frac{1}{3}} & -\frac{1}{3} < \sigma_n \leq 0 \quad \dot{\sigma}_n \leq \frac{1}{3} \\ \frac{-3\dot{\sigma}_n^2 - 2\sigma_n - \frac{1}{2}\dot{\sigma}_n^2 - \frac{1}{2}\dot{\sigma}_n}{-3\dot{\sigma}_n^2 - 2\sigma_n - 3\dot{\sigma}_n^2 - \dot{\sigma}_n + \frac{1}{3}} & -\frac{1}{3} < \sigma_n \leq 0 \quad -\frac{1}{3} < \dot{\sigma}_n \leq 0 \\ \frac{-2\dot{\sigma}_n^2 - \frac{4}{3}\sigma_n + \frac{1}{2}\dot{\sigma}_n^2 - \frac{1}{2}\dot{\sigma}_n}{-3\dot{\sigma}_n^2 - 2\sigma_n - 3\dot{\sigma}_n^2 - \dot{\sigma}_n + \frac{1}{3}} & -\frac{1}{3} < \sigma_n \leq 0 \quad 0 < \dot{\sigma}_n \leq \frac{1}{3} \\ \frac{-\frac{2}{3}\sigma_n - \frac{1}{9}}{-6\dot{\sigma}_n^2 - 2\sigma_n + \frac{1}{3}} & -\frac{1}{3} < \sigma_n \leq 0 \quad \dot{\sigma}_n > \frac{1}{3} \\ \frac{-\frac{2}{3}\sigma_n - \frac{1}{9}}{-6\dot{\sigma}_n^2 + 2\sigma_n + \frac{1}{3}} & 0 < \sigma_n \leq \frac{1}{3} \quad \dot{\sigma}_n \leq \frac{1}{3} \\ \frac{-\dot{\sigma}_n^2 + \frac{3}{2}\dot{\sigma}_n^2 + \frac{1}{6}\dot{\sigma}_n - \frac{1}{9}}{-3\dot{\sigma}_n^2 - 3\dot{\sigma}_n^2 - \dot{\sigma}_n + \frac{2}{3}} & 0 < \sigma_n \leq \frac{1}{3} \quad -\frac{1}{3} < \dot{\sigma}_n \leq 0 \\ \frac{\frac{5}{2}\dot{\sigma}_n^2 - \frac{7}{6}\dot{\sigma}_n - \frac{2}{9}}{-3\dot{\sigma}_n^2 - 3\dot{\sigma}_n^2 - \dot{\sigma}_n + \frac{2}{3}} & 0 < \sigma_n \leq \frac{1}{3} \quad 0 < \dot{\sigma}_n \leq \frac{1}{3} \\ \frac{4\dot{\sigma}_n^2 - 2\dot{\sigma}_n - \frac{1}{9}}{-6\dot{\sigma}_n^2 + 2\sigma_n + \frac{1}{3}} & 0 < \sigma_n \leq \frac{1}{3} \quad \dot{\sigma}_n > \frac{1}{3} \\ \frac{1}{3} & \sigma_n \leq \frac{1}{3} \quad \dot{\sigma}_n \leq \frac{1}{3} \\ \frac{\frac{3}{2}\dot{\sigma}_n^2 + \frac{1}{6}\dot{\sigma}_n - \frac{2}{9}}{-3\dot{\sigma}_n^2 - \dot{\sigma}_n + \frac{1}{3}} & \sigma_n \leq \frac{1}{3} \quad -\frac{1}{3} < \dot{\sigma}_n \leq 0 \\ \frac{\frac{5}{2}\dot{\sigma}_n^2 - \frac{7}{6}\dot{\sigma}_n - \frac{2}{9}}{-3\dot{\sigma}_n^2 + \dot{\sigma}_n + \frac{1}{3}} & \sigma_n \leq \frac{1}{3} \quad 0 < \dot{\sigma}_n \leq \frac{1}{3} \\ -1 & \sigma_n \leq \frac{1}{3} \quad \dot{\sigma}_n > \frac{1}{3} \end{array} \right. \quad (15)$$

Using the same method we get the precise output  $\Delta k_i$  under other circumstances to be

for  $i=1$ ,  $\sigma_n$  is  $\sigma_n \text{sign}(x_1 - Tx_0 - rK_F)$  and  $\dot{\sigma}_n$  is  $\dot{\sigma}_n \text{sign}(x_1 - Tx_0 - rK_F)$ ; for  $i=1$ ,  $\sigma_n$  is  $\sigma_n \text{sign}(x_i)$  and  $\dot{\sigma}_n$  is  $\dot{\sigma}_n \text{sign}(x_i)$ . Finally, the control function of FLSMFC approach for simulate is obtained as

$$U = U_{eq} + k_i(x_1 - T_x - rK_f) + \sum_{i=2}^n k_i x_i + K \left[ \Delta k_i(x_1 - T_x - rK_f) + \sum_{i=2}^n \Delta k_i x_i \right] \quad (16)$$

Among them,  $U_{eq}$  is given by (5),  $k_i$  is given by inequality (11),  $\Delta k_i$  is given by (15), therefore  $U$  is a continuous function.

#### IV. DC SERVOMOTOR MODELING

The DC servomotor considered in the paper is a permanent magnet DC motor as shown in Fig. 6. The voltage and electromagnetic torque equation can be expressed as :

$$V_a = R_a i_a + L_a \frac{di_a}{dt} + V_b \quad (17)$$

$$V_b = K_b \omega_m \quad (18)$$

$$T_m = K_t i_a(t) \quad (19)$$

The torque, velocity and position can be related by :

$$T_m = J_m \frac{d\omega_m}{dt} + B_m \omega_m + T_L \quad (20)$$

$$\theta_m = \int \omega_m dt \quad (21)$$

where  $i_a$  is the armature current,  $R_a$  is the armature resistance,  $L_a$  is the armature inductance,  $K_b$  is the back-EMF constant,  $K_t$  is the torque constant,  $J_m$  is the inertia of the motor rotor,  $B_m$  is the viscous coefficient,  $V_a$  is the armature voltage,  $V_b$  is the back-EMF,  $T_m$  is the motor torque,  $T_L$  is the load torque,  $\omega_m$  is the motor velocity,  $\theta_m$  is the motor displacement.

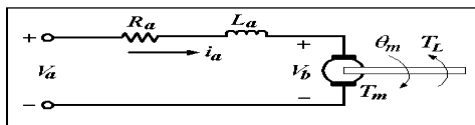

Fig. 6 The DC servomotor modeling.

The PWM-VSI as shown in Fig.1 can be simplified as a constant gain :

$$K_a = \frac{V_{DC}}{2E_d}$$

where  $V_{dc}$  is the DC supply voltage in the VSI and  $E_d$  are the triangular peak values in the PWM. Thus, the block diagram current controlled loop is shown in Fig. 7.

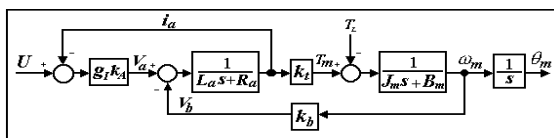

Fig. 7 Block diagram of the motor with current controlled loop.

#### V. THE FLSMFC FOR DC SERVOMOTOR DRIVES

The implementation of FLSMFC system is shown in Fig. 8. The nominal values of the FLSMFC controller and the machine parameters are listed in Table. 2 and Table. 3, respectively. The simplified dynamic model of the DC servomotor position control can be described as

$$\dot{x}_{p1} = x_{p2}, \quad \dot{x}_{p2} = x_{p3}, \quad \dot{x}_{p3} = -a_{p1}x_{p1} - a_{p2}x_{p2} - a_{p3}x_{p3} + b_p U_p - f(t) \quad (22)$$

where  $a_{p1} = 0$ ,  $a_{p2} = \frac{K_t k_b + (R_a + g_t k_A) B_m}{L_a J_m}$ ,  $a_{p3} = \frac{B_m L_a + (R_a + g_t k_A) J_m}{L_a J_m}$ ,

$$b_p = \frac{g_t k_t k_i}{L_a J_m} \text{ and } f(t) = \frac{(R_a + g_t k_A)}{L_a J_m} T_L + \frac{1}{J_m} \dot{T}_L.$$

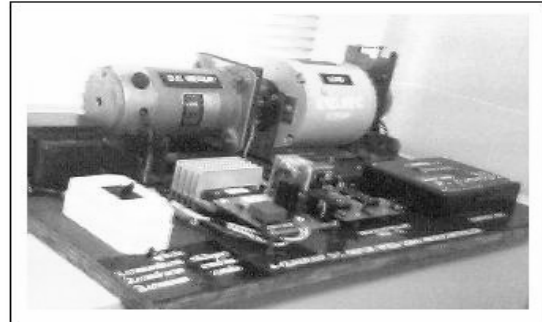

Fig. 8 The DC servomotor with FLSMFC system.

The reference model is chosen as

$$\dot{x}_{m1} = x_{m2}, \quad \dot{x}_{m2} = x_{m3} \text{ and } \dot{x}_{m3} = -a_{m1}x_{m1} - a_{m2}x_{m2} - a_{m3}x_{m3} + b_m U_m \quad (23)$$

Defining  $e_i = x_{pi} - x_{mi}$  ;( $i= 1,2,3$ ), the FLSMFC system can be represented as  $\dot{e}_1 = e_2$ ,  $\dot{e}_2 = e_3$  and

$$\dot{e}_3 = -a_{p1}e_1 - a_{p2}e_2 - a_{p3}e_3 + (a_{m1} - a_{p1})x_{m1} + (a_{m2} - a_{p2})x_{m2} + (a_{m3} - a_{p3})x_{m3} - b_m U_m + b_p U_p - f(t) \quad (24)$$

Following the design procedure we have the control law to implement as

$$U_p = \left\{ c_1 (K_t \dot{z}) + a_{p1}^0 e_1 + a_{p2}^0 e_2 - [(a_{m1} - a_{p1}^0)x_{m1} + (a_{m2} - a_{p2}^0)x_{m2} + (a_{m3} - a_{p3}^0)x_{m3} + b_m U_m] + (c_2 - a_{p3}^0)[c_1(e_1 - K_t z - rK_f) + c_2 e_2] \right\} / b^0 + (\varphi_1 |e_1 - K_t z - rK_f| + \varphi_2 |e_2| + \varphi_3 |e_3| + \varphi_4) M_\sigma(\sigma) \quad (25)$$

The switching function,  $\sigma$  from (2), is

$$\sigma = c_1(e_1 - K_t z - rK_f) + c_2 e_2 + e_3 \quad ; r = U_m \quad (26)$$

TABLE II  
 PARAMETERS of FLSMFC CONTROLLER

Parameter	Value
$\lambda_1, \lambda_2$	-15.834±20.749i
$\lambda_3, \lambda_4$	-32.518, -14.723
$C_1, C_2$	1,525, 58.72
$K_1, K_F$	28.37, 18.83
$\varphi_1, \varphi_2$	-1, -0.01
$\varphi_3, \varphi_4$	-0.0001, -0.001
$a_{m1}, a_{m2}$	12,000, 1,220
$a_{m3}, b_m$	42, 13,000
$a_{p2}^0, a_{p3}^0$	9,143.74, 2,248
$b_p^0$	50,838.39
$\delta_0, \delta_1$	2, 20

TABLE III  
 PARAMETERS OF DC SERVOMOTOR

Parameter	Value	Dimension
$R_a$	2	$\Omega$
$L_a$	0.012	$H$
$K_A$	6.5	dimensionless
$g_l$	5	dimensionless
$B_m$	0.00	$N\text{-m/s}$
$J_m$	0.0014	$Kg\text{-m}^2$
$K_b$	0.43	$V\text{-s/rad}$
$K_t$	0.43	$N\text{-m/A}$

## VI. EXPERIMENT RESULTS AND DISCUSSION

The experimental results of the dynamic response are shown in Fig. 9, where a ramp command is introduced and the motor is applied with a variable load torque and parameters variation. The results are compared with obtained from the IVSMFC and MIVSC approaches, respectively. Fig. 10, compares the position tracking errors. It is clear from the curves that FLSMFC can track the command input extremely well during steady state as well as transient periods. Among others, the FLSMFC approach gives the minimum tracking error and fast accurate tracking.

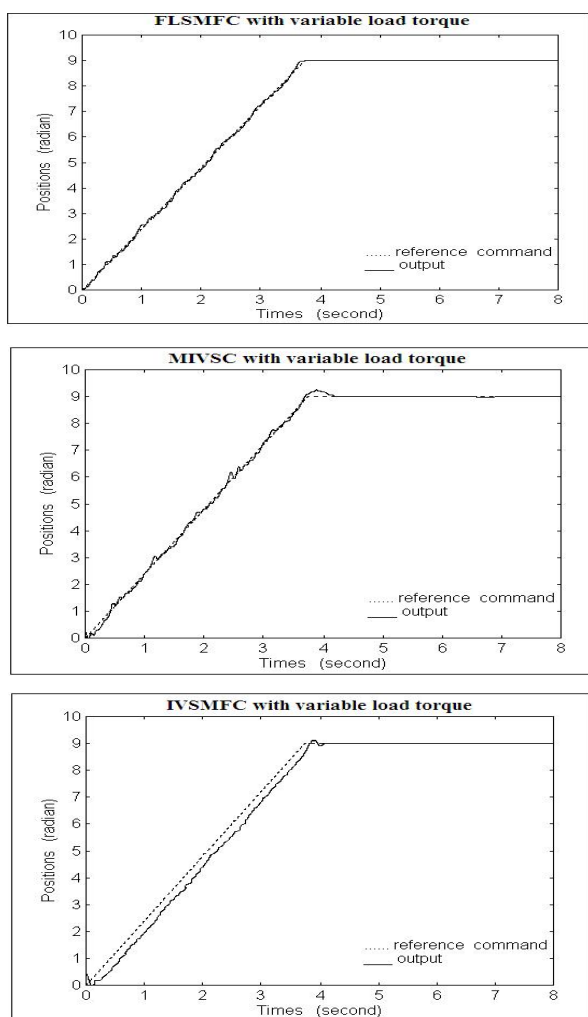

Fig. 9 Comparison of ramp position tracking.

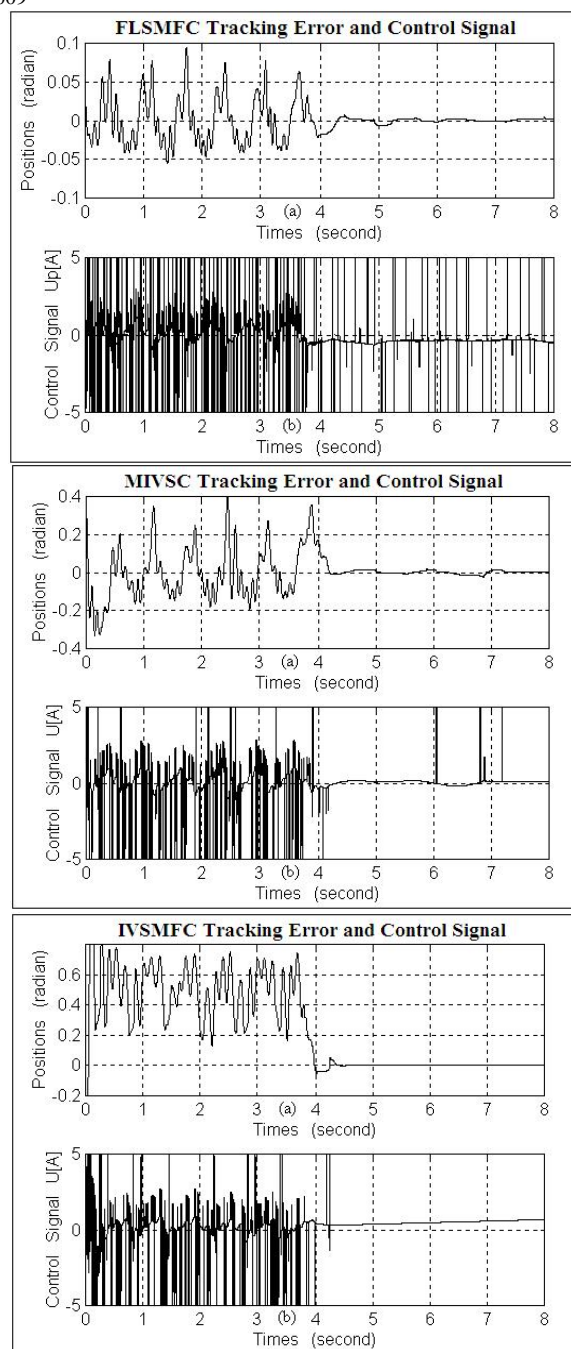

Fig. 10 Comparison of position tracking error and control signal.

## VII. CONCLUSIONS

This paper has presented the FLSMFC configuration for a DC servomotor driver. A design procedure has also been proposed for determining the control function and switching plane by using model following control. The application of FLSMFC to the DC servomotor position control system has illustrated that the FLSMFC approach can improve the tracking performance by 75% and 85% when compared to the MIVSC and IVSMFC approaches, respectively. Experimental results demonstrate that the proposed approach can achieve accurate position tracking in face of wide plant parameter variations and external load disturbance. Furthermore, The FLSMFC approach is robust and applicable to electrical machine control systems. It is therefore expected that the proposed control scheme can be applied to the high performance applications of an induction

motor such as the high precision control of machine tools and industrials.

#### REFERENCES

- [1] P.C.Krause, O.Waszynek and S.D.Sudhoff, "Analysis of Electric machinery", *IEEE press*, New York, 1995.
- [2] V.I. Utkin, J. Guldner and J. Shi, *Sliding Mode Control in Electromechanical Systems*, Taylor & Francis, 1999.
- [3] H.Y. John, G. Weibing and C.H. James, "Variable Structure Control : A Survey", *IEEE Transaction on Industrial Electronics*, Vol. 40, No. 1, Feb. 1993, pp.1-22.
- [4] P.Phakamach, "The Design and Simulation of a Fuzzy Logic Sliding Mode Controller (FLSMC) and Application to an Uninterruptible Power System Control", The International Conference on Control, Automation and Systems (ICCAS'2004), Bangkok, Thailand, 2004.
- [5] P.Phakamach, "A Variable Structure Control Based on Fuzzy Logic Algorithm with an Integral Compensation for a DC Servomotor Drives", The International MultiConference of Engineers and Computer Scientists (IMECS'2007), Hong Kong, 2007.
- [6] T.L. Chern and J. Wong, "DSP-Based Integral Variable Structure Control for DC motor servo drivers", *IEE Proceeding Control Theory Applications*, Vol. 142, No. 5, Sep. 1995, pp.444-450.
- [7] T.L. Chern and J. Chang, "DSP-Based Induction Motor Drivers Using Integral Variable Structure Model Following Control Approach", *IEEE International Electric Machine and Drives Conference Record*, 1997, pp.9.1-9.3.
- [8] S. Nungam and P. Daungkua, "Modified Integral Variable Structure Control for Brushless DC Servomotor", 21<sup>st</sup> Electrical Engineering Conference, Thailand, Nov. 1998, pp.138-141.
- [9] P.Phakamach and S.Nungam, "Design of a Sliding mode Model Following Control for Induction Motor Drivers", The second International Conference on Intelligent Technology, Thailand, 2001.
- [10] P.Phakamach, "The Design and Simulation of a Fuzzy Logic Sliding Mode Controller (FLSMC) and Application to an Uninterruptible Power System Control", The International Conference on Control, Automation and Systems (ICCAS'2004), Bangkok, Thailand, 2004.
- [11] P.Phakamach, "A Variable Structure Control Based on Fuzzy Logic Algorithm with an Integral Compensation for a DC Servomotor Drives", The International MultiConference of Engineers and Computer Scientists (IMECS'2007), Hong Kong, 2007.
- [12] S.Thongchai, "Behavior-based learning fuzzy rules for mobile robots", *American Control Conference*, Alaska, USA, May. 2002.
- [13] S.Thongchai, "A frequency modeling method of rubberactuators for control application in an IMA framework", *American Control Conference*, Virginia, USA, June. 2001.



**Phongsak Phakamach:** He was born in 1973, in Krabi, Thailand. He received the B.Eng. degree in electronics engineering from South-East Asia University in 1998 and M.Eng. degree in electrical engineering (Automatic Control System) from King Mongkut's Institute of Technology North Bangkok in 2000. He has a Ph.D. in Education Administration from North Eastern University, Thailand in 2009.

He was member of Electrical Engineering/Electronic, Computer Telecommunications and Information Technology (ECTI) Association of Thailand in 2005. His current research interests include the automatic control system, motor drives and mechatronic engineering.